



# Instruction Manual

## RS-5200

### 146-4657

# PARTICLE MASS COUNTER

EN FR IT

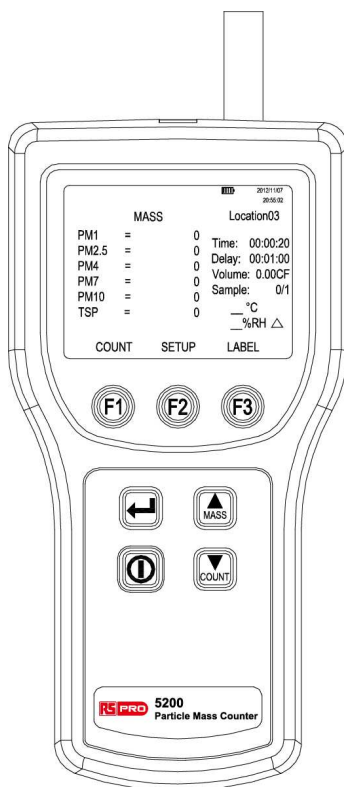

## CONTENTS

Title	Page
<b>1. SAFETY INFORMATION</b> .....	<b>1</b>
<b>2. GENERAL INFORMATION</b> .....	<b>2</b>
<b>3. SPECIFICATIONS</b> .....	<b>3</b>
<b>4. QUICK START</b> .....	<b>5</b>
<b>5. CONTROLS AND FUNCTIONS</b> .....	<b>6</b>
<b>6. DISPLAY</b> .....	<b>7</b>
6-1 Main Screen.....	7
6-2 Setup Screen .....	8
6-3 Label Menu Screen.....	10
<b>7. USING THE METER</b> .....	<b>13</b>
7-1 Setup .....	13
7-2 Counter Operation .....	19
<b>8. MAINTENANCE</b> .....	<b>24</b>
8-1 Cleaning the Case .....	24
8-2 Charging the Battery and Using the AC Adapter .....	24
8-3 Purging the Meter Sensor.....	25





## 1. SAFETY INFORMATION

A **Warning** identifies a condition or action that pose hazard(s) to the user; a **Caution** identifies a condition or action that may damage the meter or the equipment under test.

Read this entire manual before using the meter.

Safety labels used in this manual and on the meter are as follows.

### Precautionary labels

Label	Meaning
	Risk of Danger. Important information. Refer to manual.
	Hazardous voltage. Risk of electrical shock.
	Do not dispose of this product as unsorted municipal waste.
	Conforms to relevant European Union directives.



### Warning

To avoid electric shock, injury, or damage to the meter, follow these safety guidelines:

- Use the meter only as described in this Instruction Manual, otherwise the protection provided by the meter may be impaired.
- Do not use the meter in explosive atmospheres.
- The meter contains no user-serviceable parts. Do not open the meter.
- Have the meter serviced only by qualified service personnel.
- Inspect the meter before use.  
Do not use it if it appears damaged.
- Always use the ac adapter/charger and connector appropriate for the voltage and outlet of the country or location in which you are working.

**Caution**

To avoid possible damage to the meter:

- Avoid using the meter in an excessively dirty or dusty atmosphere. Excessive particle intake can damage the meter.
- Remove the isokinetic probe cap before the startup. Not doing so can damage the meter.
- Do not use a wrench to connect or disconnect the isokinetic probe. Finger-Tighten the connection.

## 2. GENERAL INFORMATION

**Note**

When using the meter for the first time, or when reusing the unit after an interval of a month or longer, be sure to charge the battery for at least 20 minutes before turning on the power.

**Warning**

Read “Safety Information” before using the meter.

The meter is a full featured, battery operated, handheld particle counter or mass monitor. In the count mode the meter will measure particle counts at fixed sizes of 0.5  $\mu\text{m}$ , 0.7  $\mu\text{m}$ , 1.0  $\mu\text{m}$ , 2.5  $\mu\text{m}$ , 4.0  $\mu\text{m}$ , 5.0  $\mu\text{m}$ , 7.0  $\mu\text{m}$  and 10.0  $\mu\text{m}$ . In the mass mode the meter will measure PM1, PM2.5, PM4, PM7, PM10 and TSP mass concentration levels. It holds 500 samples in flash memory and records the date, time, counts or mass, sample volume, temperature, and relative humidity of each sample. The data can be easily downloaded to a personal computer using the USB interface cable.

The meter is commonly used for the following:

- HVAC Applications
- Controlled Environments
- Filter Testing
- Indoor Air Quality
- Mining & Ore Processing
- Hospitals & Clinics
- Emission Sourcing
- Monitoring Growing Rooms



### 3. SPECIFICATIONS

**Operating principle:** Counts individual particles using scattered laser light and calculates the equivalent mass concentration using a proper algorithm.

**Optical system:** Sideway light-scattering method

**Light source:** Laser diode

**Laser product class:** Class 1, IEC 60825-1 / EN 60825-1

**Mass Mode:**

**Mass concentration ranges:** PM1, PM2.5, PM4, PM7, PM10, and TSP

**Concentration range:** 0 to 1000  $\mu\text{g}/\text{m}^3$

**Sample time:** 1 minute (2.83 L / min)

**Count Mode:**

**Particle size:** 0.5  $\mu\text{m}$ , 0.7  $\mu\text{m}$ , 1.0  $\mu\text{m}$ , 2.5  $\mu\text{m}$ , 4.0  $\mu\text{m}$ , 5.0  $\mu\text{m}$ , 7.0  $\mu\text{m}$ , 10  $\mu\text{m}$

**Accuracy:**  $\pm 10\%$  to calibration aerosol.

**Sensitivity:** 0.5  $\mu\text{m}$

**Sample flow rate:** 2.83 L / min

**Maximum particle concentration:** 70000 particles / L (coincidence loss max. 5%)

**Sample time:** 6 s. (0.01 CF), 21 s. (1L), 1 min. (0.1 CF, 2.83L), 3 min. 32 s (10L), 10 min. (1 CF, 28.3L), any length (MANUAL), any length (1 s. to 59 min. 59 s.)

**Relative humidity:**  $\pm 7\%$ , 20 % RH to 90 % RH, non-condensing

**Temperature:**  $\pm 3\text{ }^\circ\text{C}$ , 10  $^\circ\text{C}$  to 40  $^\circ\text{C}$  (50  $^\circ\text{F}$  to 104  $^\circ\text{F}$ )

**Data storage (Flash memory):** 500 sample records (rotating buffer) in Mass mode.

500 sample records (rotating buffer) in Count mode.

**Data recorded:** Date, time, counts or mass, relative humidity, temperature, sample volumes, alarms, label

**Display:** TFT color display with backlight

**Count modes:** Concentration, totalize, audio



**Delay time:** 0 to 24 hours

**Sample inlet:** Isokinetic probe

**Interface:** USB

**Vacuum source:** Internal pump flow controlled

**Dimensions:** 11.0 x 21.8 x 6.7 cm (4.33 " x 8.58 " x 2.64 ")

**Weight:** 875 g

**Environmental:**

**Operating:** 10 °C to 40 °C (50 °F to 104 °F), 20 % to 90 % RH, non-condensing

**Storage:** -10 °C to 50 °C (14 °F to 122 °F), Up to 90 % RH, non-condensing

**Power:** AC Adapter, 12 VDC at 3 A, 100 to 240 VAC, 50 to 60 Hz

**Rechargeable Battery:** Lithium ion, 8.4 V at 2.5 Ah; replaceable

**Charge time:** 2.5 hours (Fast Charge mode), 27 hours (Trickle Charge mode)

**Continuous Operating Time:** 4 hours

**Standards:** Complies with CE, JIS B9921: 1997, ISO 21501-4





**Accessories:** Instruction manual, AC adapter, Power cord, USB cable, Zero count filter, Hard-shell carrying case.



## 4. QUICK START

The meter may be used directly out of the box.

**To immediately use the meter:**

1. Read **“Safety Information”**
2. Remove the Isokinetic probe cap.
3. Press the  (POWER) key.
4. Press  key to select MASS mode or Press  key to select COUNT mode.
5. Press  (COUNT) key to start sampling.

Be sure to read this entire manual for more detailed information.

## 5. CONTROLS AND FUNCTIONS

### Parts description:

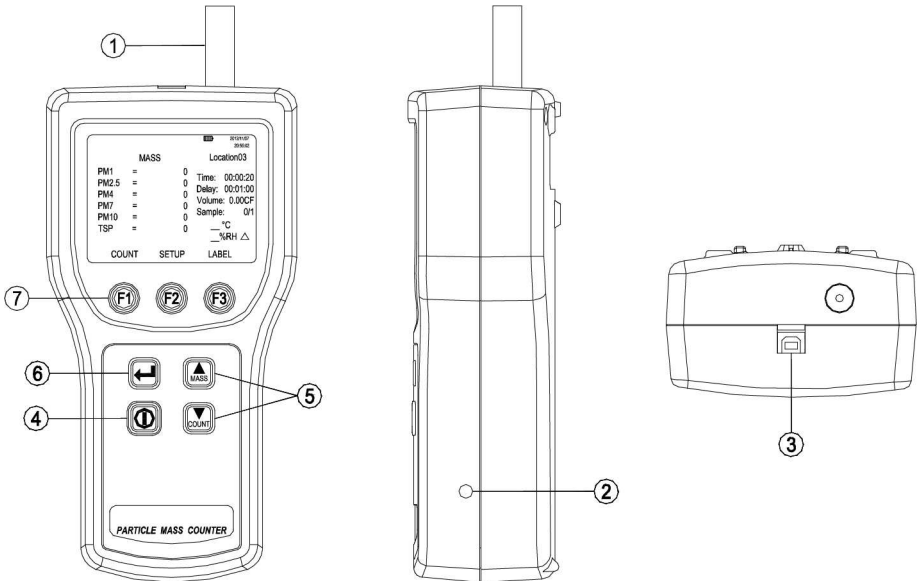

1. **Isokinetic probe and cap.**



2. **External power:** 12 VDC, 3 A External power.

3. **USB Port.**







4.  **Power key:** Press to turns the meter on and off.

5.   **Arrow keys:**

① Press  key to select MASS mode or press  key to select COUNT mode.

② Press to scroll within the selected screen.

6.  **Return key:** Press to store the setup changes and to return to the main screen.

7.    **Function keys:** Each function key corresponds to a name above each function key. Different menus have different labels above the keys.



## 6. DISPLAY

Press the corresponding button from the keypad at the bottom of the LCD to invoke the following screens:

- Main screen
- Setup screen (pages 1, 2 and 3)
- Label menu screen

### 6-1 Main Screen

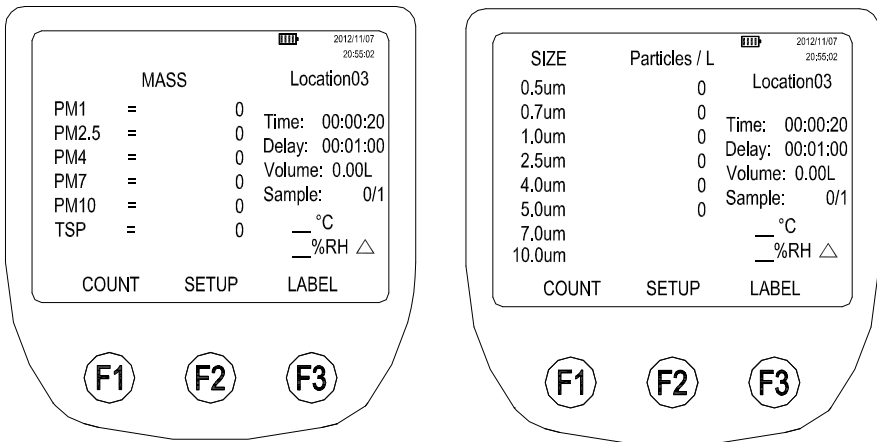

The Main screen appears after the meter is turned on and after the opening screen appears.

#### The Main screen includes:



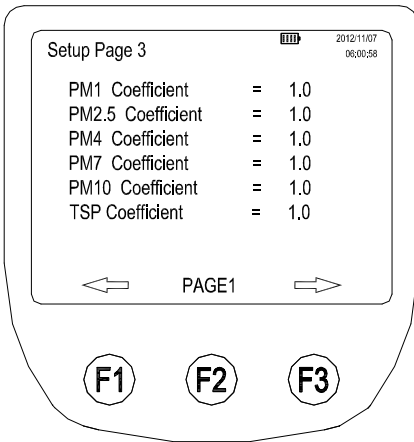
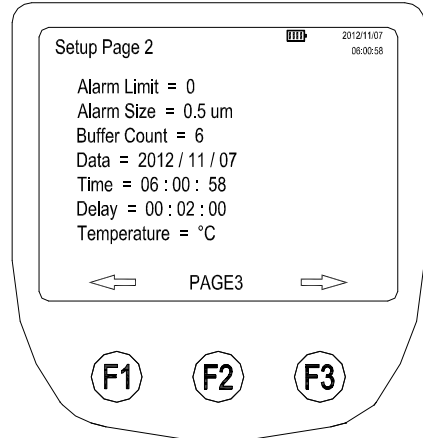
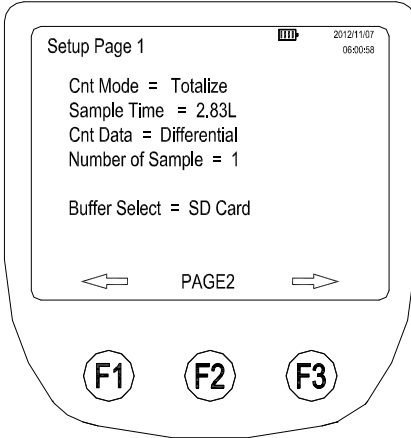

- Six mass ranges and corresponding concentration values. (MASS Mode)
- Eight channel sizes and corresponding counts. (COUNT Mode)
- Battery-charge indicator (amount of charge remaining in the battery).
- Sample location name.
- Time indicator (represents time to complete).
- Delay time.
- Sampled volume indicator.
- Number of samples.
- Sample air temperature (°C or °F).
- Sample air relative humidity (%RH).
- Particle count mode.

The parameters on the Main screen are selected by using the Setup screens and the Label setup menu.

## 6-2 Setup Screen



- From the Main screen, press **F2** (SETUP) key, the Setup screen Page 1 appears.  
 Press **F2** key again to select the desired setup screen pages.

2. Press  and  keys to move up and down through each parameter.  
Press  (left arrow) and  (right arrow) keys to navigate within each screen entry that is highlighted.
3. Press  (RETURN) key to store the setup changes and to return to the Main screen.

**The setup screen page 1 includes:**

- Type of count mode (Concentration, Totalize or Audio)
- Sample volume (in L or CF) or sample time (h:m:s)
- Type of count data (Cumulative or Differential)
- Number of samples
- Buffer select (Flash or SD card)

**The setup screen page 2 includes:**

- Alarm limit (1 to 100,000)
- Alarm size (size of particles)
- Buffer count (number of samples stored in the buffer)
- Date (YYYY/MM/DD)
- Time (h:m:s)
- Delay time (h:m:s)
- Temperature units °C or °F

**The setup screen page 3 includes:**

- List of mass ranges K-factors coefficient.

Tailored Mass Conversion:

The particle counts from the eight size ranges are converted to mass using a proper algorithm for typical – density aerosols. Accommodation for special particulate with different densities is provided through user – edit “K-factors” coefficient.

## 6-3 Label Menu Screen

It may be useful to assign labels to samples taken from different areas or rooms. Use the Label menu to select sample labels.

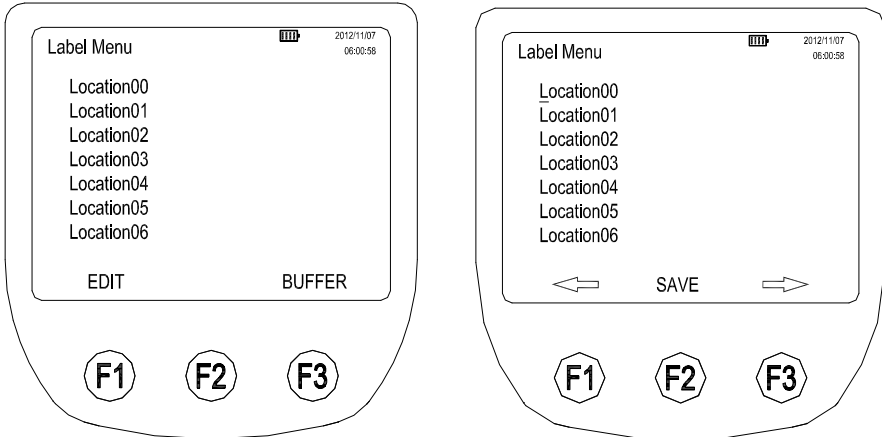

### 6-3-1 To edit labels using the keypad:

1. Press **F3** (LABEL) key on the main screen to display the Label Menu screen.
2. Press **▲** or **▼** key to select the desired location number from 00 to 76.
3. Once the location number is selected, press **F1** (EDIT) key.
4. The large cursor changes to a single-character cursor. Press **▲** and **▼** keys to scroll through the characters a to z, 0 to 9, A to Z and space.
5. Press **F1** (left arrow) or **F3** (right arrow) key to move to the next character.
6. Once the desired label name is entered, press **F2** (SAVE) key to store the new label name.
7. Continue to edit label names by following the previous process. When finished, press **↵** (RETURN) key to return to the Main screen. Notice that the Main screen now has the sample label in the upper right hand corner.



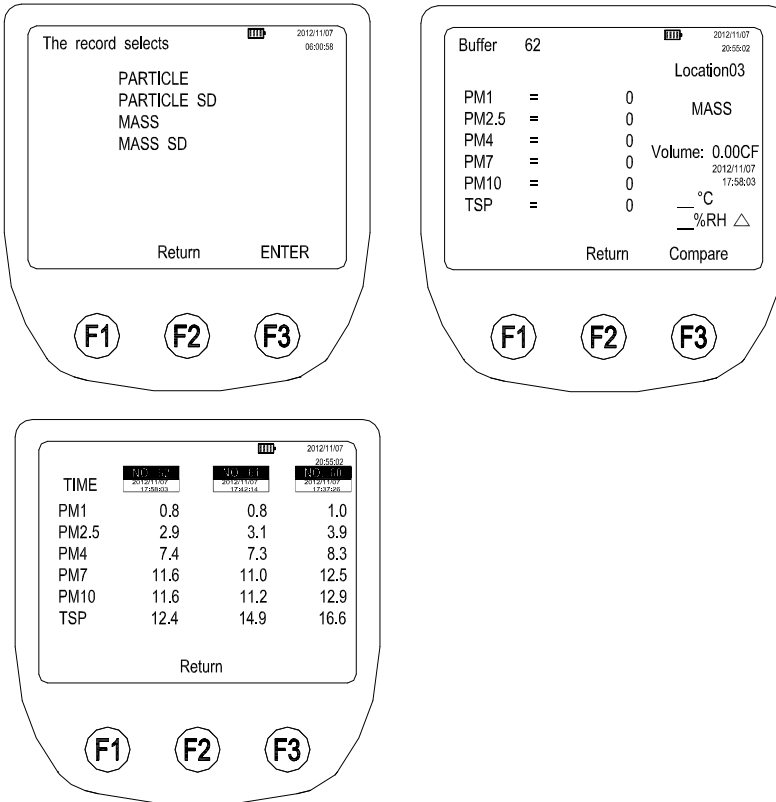



### 6-3-2 To reviewing the buffer:



### The Label menu screen includes:

- List of location labels.

1. Press **F3** (LABEL) key on the main screen to display the Label Menu screen.
2. Press **F3** (BUFFER) key to recall the buffer.

3. Press  or  key to select the particle or mass mode and its memory buffer.
4. Press  (ENTER) key, the Buffer review screen and the last record stored in the buffer is displayed.
5. Press  or  key to scroll through the different samples.
6. Press  (Compare) key to compare the last three results stored.
7. Press  (Return) key two times to return to the Main screen.



## 7. USING THE METER

The following sections give detailed information about using the meter.

### 7-1 Setup

#### To set up the meter:

Go through the different screens and set the desired parameters for sampling. Refer to previous sections regarding the different screens and menus.

#### 7-1-1 Setting the Counting mode:

**The counting mode choices are:**

##### **Concentration mode:**

The Concentration mode is used to take a quick glimpse of airborne particle contamination levels. For example, this mode might be used in areas where particulate levels are unknown and may exceed the operating levels of the meter. The meter estimates the count per cubic foot or liter depending on the volume selected. This mode should not be substituted for full sampling.





##### **Totalize mode:**

In Totalize mode, the particle counts are displayed and accumulate as sampled. When the sample is complete, the record is stored and the value is displayed on the screen until the next sample is started.

##### **Audio mode:**

In Audio mode, the meter beeps once each time the alarm limit is exceeded. For example, if the limit is set to 10, the meter beeps when the count first reaches 10 and beeps again for every multiple of 10. In Audio mode, the display shows counts as in Totalize mode.

**To set the counting mode:**





1. Press  (SETUP) key on the Main screen. The Setup page 1 screen is displayed with the current "**Cnt Mode**" field selected.
2. Press  (left arrow) or  (right arrow) key to select the desired count mode.
3. When the desired mode shows on the screen, press  (RETURN) key to select that mode and return to the Main screen.

### 7-1-2 Setting the air sampling volume or sampling time:







**In the MASS mode, the sample time is fixed at 60 seconds (2.83L).**

**In the COUNT mode:**

**To set the sample volume or sample time:**

1. Press  (SETUP) key on the Main screen. The Setup page 1 screen is displayed with the current “**Cnt Mode**” field selected.
2. Press  key to move to the “**Sample Volume**” or “**Sample Time**” field.
3. To select a sample volume, sample time, or to manually stop the meter, press  (left arrow) or  (right arrow) key.

**If Sample Time CF or Sample Time L is selected:**

4. Press  (EDIT) key to edit the sampling time.
5. Press  (left arrow) or  (right arrow) key to highlight the desired hours, minutes, or seconds digit.
6. Once the hours, minutes or seconds digits are selected, press  or  key to change the values.
7. Press  (Save) to save the settings and return to the previous screen.
8. Press  (RETURN) key to select the desired volume or time and return to the Main screen. The time selected appears on the right of the Main screen.

In Sample volume mode the display shows the calculated time in either liters or cubic feet, based on the volume selected.

**The choices for the sample volume setting are:**

- 1.0L (counts for 21 seconds)
- 2.83L (60 seconds)
- 10.0L (3.53 minutes)
- 28.3L (10 minutes)
- 0.01CF (6 seconds)
- 0.1CF (60 seconds)
- 1.0CF (10 minutes)
- MANUAL - Select this option to continuously sample and display the counts until the unit is stopped manually. The display shows the total volume sampled in litres.







### 7-1-3 Setting the method of counting data:

**The choices for data counting are:**

**Cumulative** – Includes all particles that are larger than or equal to the particle size selected in the sample volume field.

**Differential** – Includes all particles that are larger than or equal to the particle size selected in the sample volume field, but small than the next largest particle size.

**To set the method for counting data:**





1. Press  (SETUP) key on the Main screen. The Setup page 1 screen is displayed with the current “**Cnt Mode**” field selected.
2. Press  key to move to the “**Cnt Data**” field.
3. Press  (left arrow) or  (right arrow) key to change the method of counting data.
4. Press  (RETURN) key to select the desired data counting method and to return to the Main screen.

The method selected appears as a symbol on the display.

The SUM symbol (  $\Sigma$  ) denotes the Cumulative method and the DELTA symbol (  $\Delta$  ) denotes the Differential method.

### 7-1-4 Setting the number of samples:

**To set the number of samples:**

1. Press  (SETUP) key on the Main screen. The Setup page 1 screen is displayed with the current “**Cnt Mode**” field selected.
2. Press  key to move to the “**Number of Samples**” field.
3. Press  (left arrow) or  (right arrow) key to select the desired number of samples from 1 to 500.
4. When the desired number appears, press  (RETURN) key to return to the Main screen.

### 7-1-5 Setting the memory buffer:

The meter can store measurement data in the internal flash memory or on micro SD card.

#### To set the memory buffer:

1. Press **F2** (SETUP) key on the Main screen. The Setup page 1 screen is displayed with the current “**Cnt Mode**” field selected.
2. Press **▼** key to move to the “**Buffer Select**” field.
3. Use **F1** (left arrow) or **F3** (right arrow) to select “**Flash**” or “**SD Card**”.
4. Press **↵** (RETURN) to save the choice and return to the Main Screen.

### 7-1-6 Setting the alarm count and size:

When the alarm is set, an audible alarm is triggered when the count reaches the count limit on the selected particle size.

#### To set the alarm count and size:











1. Press **F2** (SETUP) key on the Main screen. The Setup Page 1 screen is displayed.
2. Press **F2** (PAGE 2) key on the Setup Page 1 screen. The Setup Page 2 screen is displayed.
3. Alarm Limit is highlighted. Press **F1** (left arrow) or **F3** (right arrow) key to move the alarm limits from zero (no alarm) to 100,000 in factors of 10.
4. When the required limit is selected, press **▼** key to select the “**Alarm Size**” field.
5. Press **F1** (left arrow) or **F3** (right arrow) key to display the various particle sizes.
6. Select the desired particle size and press **↵** (RETURN) key to return to the Main screen.

**Note:** When the alarm sounds, pressing **F1** (STOP) key once will mute the alarm.

Pressing **F1** (STOP) key again will stop the sample.

### 7-1-7 Setting the date and time:







#### To set the date and time:





1. Press  (SETUP) key on the Main screen. The Setup Page 1 screen is displayed.
2. Press  (PAGE 2) key on the Setup Page 1 screen. The Setup Page 2 screen is displayed.
3. Press  or  key to move the cursor to “**Date**” or “**Time**” field.
4. Press  (PROGRAM) key to enter the edit mode. Once in this mode, press  and  keys to increase or decrease the selected entry.
5. Use  (left arrow) and  (right arrow) to change the entry selected.
6. Once the correct data has been entered, press  (SAVE) key to store the data.
7. Press  (RETURN) key to return to the Main screen.

### 7-1-8 Setting a delay between samples:

If continuous sampling is not necessary, a delay can be set. The delay timer allows a “**time out**” between automatic samplings.

#### To set a delay time:







1. Press  (SETUP) key on the Main screen. The Setup Page 1 screen is displayed.
2. Press  (PAGE 2) key on the Setup Page 1 screen. The Setup Page 2 screen is displayed.
3. Press  key to move the cursor to “**Delay**” field.
4. Press  (PROGRAM) key to enter the edit mode.
5. Use  (left arrow) and  (right arrow) key to move to the desired unit of time (hours, minutes, or seconds).

6. Press  to increase the time; press  to decrease the time.
7. Once the desired time has been selected, press  (SAVE) key.
8. Press  (RETURN) key to return to the Main screen.

**Note:** The maximum delay time is 23:59:59.

### 7-1-9 Setting the temperature unit:

**To set the Temperature unit to ° F or ° C:**

1. Press  (SETUP) key on the Main screen. The Setup Page 1 screen is displayed.
2. Press  (PAGE 2) key on the Setup Page 1 screen. The Setup Page 2 screen is displayed.
3. Press  or  key to move the cursor to “Temperature”.
2. Use  (left arrow) or  (right arrow) key to select “°F” or “°C”.
3. Press  (RETURN) key to save the choice and return to the Main screen.











### 7-1-10 Setting the K-Factor coefficients:

The meter counts the particles in 8 different size ranges then use a proper algorithm to convert count data to mass measurements ( $\mu\text{g}/\text{m}^3$ ).

Fundamentally, the meter calculates a volume for each detected particle then assigns a standard density for the conversion.

The standard density value is adequate for most sampling environments. However, some environments are heavily influenced by high or low density materials which can reduce measurement accuracy. For these environments, the meter provides a K-Factor setting for each measurement range (PM1, PM2.5, PM4, PM7, PM10 and TSP).

### To set the K-Factor coefficients:

1. Press  (SETUP) key on the Main screen. The Setup Page 1 screen is displayed.
2. Press  (PAGE 2) key on the Setup Page 1 screen. The Setup Page 2 screen is displayed.
3. Press  (PAGE 3) key on the Setup Page 2 screen. The Setup Page 3 screen is displayed.
4. Press  or  key to move the cursor to the desired measurement range.
5. Press  (EDIT) key to enter the edit mode.
6. Press  or  key to setting the desired coefficient value from 0.1 to 9.99 (default value is 1.00).
7. Once the desired value has been selected, press  (SAVE) key.
8. Press  (RETURN) key to return to the Main screen.

## 7-2 Counter Operation

Once the meter configuration is set:

- Use the zero count filter to purging the meter.
- Collect the air samples.
- Transfer the data from the air sample to PC for further analysis.
- Review the number of samples in the buffer.
- Clear the buffer if necessary.

## 7-2-1 Purging the Particle Counter:

Before taking particle samples, the meter should be purged using the zero count filter.

**Purging the meter will make sure the readings are accurate.**

**To purge the meter:**

1. Fit the filter adapter onto the end of the zero count filter. Note the arrow on the filter denoting airflow direction.
2. Connect the adapter directly onto the end of the isokinetic probe.
3. Operate the unit for approximately 5 minutes in count mode.
4. Verify the data on the display:
  - On average, not more than one particle greater than 0.5  $\mu\text{m}$  in five minutes or not more than one particle per 0.5 cubic foot should be apparent.
  - Once the unit has been purged, resume normal use. Remove the zero count filter from the isokinetic probe.



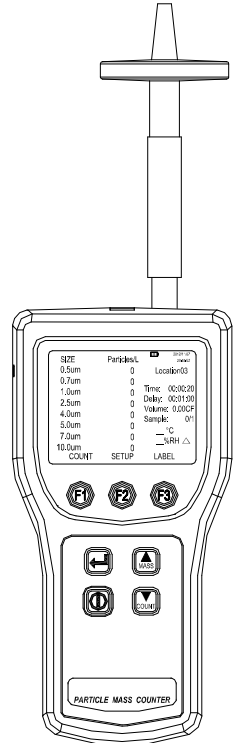



In a clean-room application, the zero count filter verifies that the meter is not false counting due to sensor leakage, internal or external interference or any other reason. In other applications, the zero count filter purges the sensor immediately after a high-concentration sampling. If the unit fails, see “**Purging the Meter Sensor**”.





### 7-2-2 Collect samples:

**Important Caution:** Remove the isokinetic probe cap so that the isokinetic probe is not obstructed. Not doing so can damage the meter.

**To collect samples:**

1. Press the  (POWER) key to turn on the meter.
2. If needed, select the required setting on the setup screen. Press  (SETUP) key, then select the required settings on the setup Page 1 screen.
3. Press  (Page 2) key to select the required settings on the setup Page 2 screen.
4. Press  (RETURN) key to return to the Main screen.
5. Press  key to select MASS mode or press  key to select COUNT mode.

**In MASS mode:**

1. Press  (COUNT) key on the MASS screen to start sampling. The cycle will automatically stop on completion of sample.
2. Press  key to cycle through the display of the MASS screen and the MASS count screen.

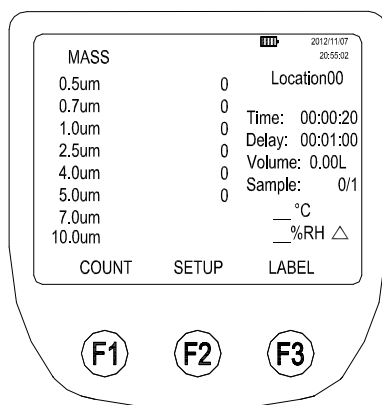
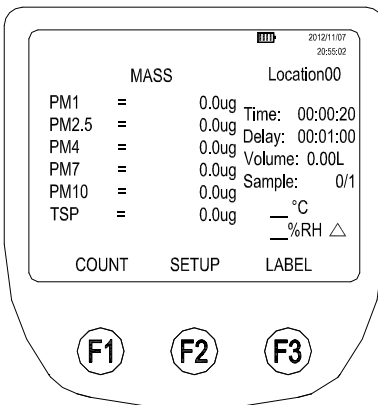

### In COUNT mode:

Press **F1** (COUNT) key on the Main screen to start sampling. The cycle will automatically stop on completion of the sample. If the Sample Volume is set to Manual, the meter will continuously samples until the **F1** (Stop) key is pressed.

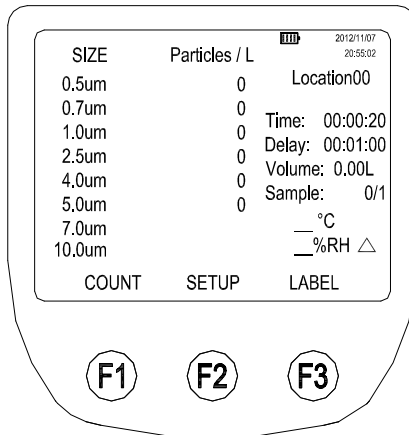

### 7-2-3 Transfer sample data to PC:

#### To transfer sample data from the meter to a PC:

1. Connect USB cable to PC and the meter.
2. Power on the PC, until the PC into the Window screen then press the **⏻** (POWER) key to turn on the meter.

### 7-2-4 Storing samples data:

The meter stores each sample data in a 500-record rotating buffer. Data is stored in a “**first in, first out**” order. Thus, when the 501st record is saved, the first record is automatically deleted, leaving a total of 500 records.



### 7-2-5 Review the buffer:

To review the buffer: (Refer to 6-3-2)



### 7-2-6 Display the number of samples in the buffer:

To display the number of samples in the buffer:







1. Press  (SETUP) key on the Main screen.
2. Press  (PAGE 2) key on the Setup screen.

The number of samples in the buffer is displayed in the “**Buffer Count**” field.

### 7-2-7 Clearing the buffer:

At some point, the user may wish to clear the meter buffer.

To clear the buffer:

1. Press  (SETUP) key on the Main screen.
2. Press  (PAGE 2) key, the Setup Page 2 screen is displayed.
3. Press  key to move the cursor to “**Buffer Count**”. Buffer Count displays the number of samples stored in memory.
4. Use  (left arrow) or  (right arrow) key to enter “**Clear Flash**” or “**Clear SDcard**” indication. It depend on the “**Buffer Select**” setting (refer to 7-1-5).
5. Press  (CLEAR) key to clear the buffer.
6. Press  (RETURN) key to return to the Main screen.

## 8. MAINTENANCE



### Warning

The Meter contains no user-serviceable parts. To avoid electric shock, injury, or damage to the meter, do not open the meter.

Use the zero count filter to ensure that the meter filter is free of contamination. Refer to “Purging the Meter”.

### 8-1 Cleaning the Case

Periodically wipe the case with a damp cloth and mild detergent.



### Caution

To avoid damaging the meter, do not use abrasives or solvents to clean the meter case.

### 8-2 Charging the Battery and Using the AC Adapter

Recharge the battery as soon as “**LOW BATTERY**” appears on the display.

The battery symbols on the display show the status of the battery:

 ++ The battery is in “**Fast Charge**” mode.

The ac adapter is connected and the battery is charging. When the battery is below 95 % of its charge, the meter uses “**Fast Charge**” mode to bring the battery back up to 95 %.

 + The battery is in “**Trickle Charge**” mode. Once 95 % of the charge is attained, the meter switches to “**Trickle Charge**” mode to charge the remaining 5 % of the battery.

 -- The battery is in “**Precharge**” mode.

 The battery is fully charged.

 The battery is partially charged.

The ac adapter is used to recharge the battery as well as power the meter. This feature allows the meter to be used while the battery is charging.

**To connect the ac adapter:**

1. Attach the power cord to the end of the ac adapter.
2. Plug the ac adapter into the 12V jack on the meter.
3. Plug the power cord into an ac outlet. The meter will take 2.5 hours to fully charge.

**Note:**

1. If the Meter is powered off during charging (**Trickle Charge mode**), the battery will require up to 27 hours for a full charge. To charge the battery in 2.5 hours, the meter must be turned on while charging (**Fast Charge mode**).
2. When the battery capacity is below 25% () , the meter cannot perform the particle count mode and the “Low Battery” mark is displayed.

**8-3 Purging the Meter Sensor****Caution**

**To avoid possible damage to the meter, avoid using the meter in an excessively dirty or dusty atmosphere.**

**Excessive particle intake can damage the meter.**

**To purge the particle counter sensor:**

1. Fit the adapter onto the end of the zero count filter.  
Note the arrow on the filter denoting airflow direction.
2. Connect the adapter directly onto the end of the isokinetic probe.
3. Operate the unit for approximately 15 minutes.
4. On average, not more than one particle greater than 0.5  $\mu\text{m}$  in five minutes or not more than one particle per 0.5 cubic foot should be apparent.

Once the unit is purged, resume normal use. Remove the zero count filter and adapter from the isokinetic probe.

