

Datasheet

RS 0 → 6bar Gauge Pressure Switch for Gas, Liquid, 10 → 30 V dc, IP67





RS Stock number 518-4428



Brief description

Pressure transmitters are used for measuring the relative (gauge) pressure in liquids and gases. The pressure transmitter incorporates a thick-film strain gauge as a measuring device. The pressure sensor has an aluminium-oxide (Al₂O₃) ceramic base material. The pressure is converted into an electrical signal.

Electrical connection

Connection			Terminals			
			Terminal box 61	Cable 11	M12x1 36	Bayonet 53
Supply 10 – 30 V DC 11.5 – 30 V DC 5 V DC	(with output) (1 – (5)6 V) (0 – 10 V) (0.5 – 4.5 V)		1 L+ 2 L-	white + brown -	1+ 2-	1+ 2-
Output 1 – (5)6 V 0 – 10 V 0.5 – 4.5 V			2 - 3 +	brown - yellow +	2- 3+	2- 3+
Supply 10 – 30 V DC	(with output) (4 – 20 mA, 2-wire)		1 L+ 2 L-	white + brown -	1+ 3-	1+ 3-
Output 4 – 20 mA, 2-wire			1 + 2 -	white brown	1+ 3-	1+ 3-

proportional current 4 – 20 mA
in supply



Technical data

Reference conditions

to DIN 16 086 and IEC 770/5.3

Ranges

see order details

Overload limits

for ranges

0 – 40 bar 3 x full scale

ranges

0 – 60 to 0 – 100 bar 2 x full scale

Bursting pressure

ranges 0 – 40 bar ≤ 5 x full scale

ranges

0 – 60 to 0 – 100 bar 3 x full scale

Parts in contact with medium

standard: st. steel, Mat. Ref. 1.4305,
(Al₂O₃) 96%

seal: FPM or FFPM
or CR

Output

4 – 20 mA

2-wire burden $\leq (U_B - 10 \text{ V}) / 0.02 \text{ A}$

0.5 – 4.5 V burden $\geq 20 \text{ k}\Omega$

1 – (5)6 V burden $\geq 10 \text{ k}\Omega$

0 – 10 V burden $\geq 10 \text{ k}\Omega$

Burden error

$< 0.5\%$ max.

Zero offset

$\leq 0.3\%$ of full scale

Thermal hysteresis

$\leq \pm 0.8\%$ of full scale

Ambient temperature error

within range -20 to $+85^\circ\text{C}$

(compensated temperature range)

zero: $\leq 0.02\%/^\circ\text{C}$ typical,
 $\leq 0.04\%/^\circ\text{C}$ max.

span: $\leq 0.02\%/^\circ\text{C}$ typical,
 $\leq 0.04\%/^\circ\text{C}$ max.

Deviation from characteristic

$\leq 0.5\%$ of full scale

(limit point adjustment)

Protection

with terminal box

IP65 to EN 60 529

(diameter of connecting cable
5 mm min., 7 mm max.)

with connecting cable or

circular connector M 12 x 1

IP67 to EN 60 529

Housing

stainless steel, Mat. Ref. 1.4305

EPDM

Hysteresis

$\leq 0.2\%$ of full scale

Repeatability

$\leq 0.1\%$ of full scale

Response time

≤ 3 msec max.

Stability per year

$\leq 1\%$ of full scale

Supply

10 – 30 V DC (for output 4 – 20 mA
and 1 – (5)6 V)

5 V DC (for output 0.5 – 4.5 V)

11.5 – 30 V DC (for output 0 – 10 V)

Ripple: the voltage spikes must not go
above or below the values specified for the
supply

max. current drawn: approx. 25 mA

Supply voltage error

$\leq 0.02\%$ per V

(nominal supply voltage 24 V DC)

ratiometric with supply 5 V DC (± 0.5 V)

Permissible ambient temperature

for version with plug:

-20 to $+125^\circ\text{C}$

for version with attached cable:

-20 to $+100^\circ\text{C}$

Storage temperature

-40 to $+125^\circ\text{C}$

for version with attached cable

-20 to $+100^\circ\text{C}$

Permissible temperature of medium

-30 to $+125^\circ\text{C}$

Electromagnetic compatibility (EMC)

to EN 61 326

Mechanical shock

(to IEC 68-2-27)

100 g/1 msec

Mechanical vibration

(to IEC 68-2-6)

20 g max. at 15 – 2000 Hz

Pressure connection

see order details;

other connections on request

Electrical connection

see order details

terminal box to DIN 43 650, style A,
conductor cross-section up to 1.5 mm²
or

attached 4-core PVC cable, length 2 m,

other lengths on request

or

4-pole circular connector, M12x1

Nominal position

any

Weight

100 g

Dimensions

Electrical connections

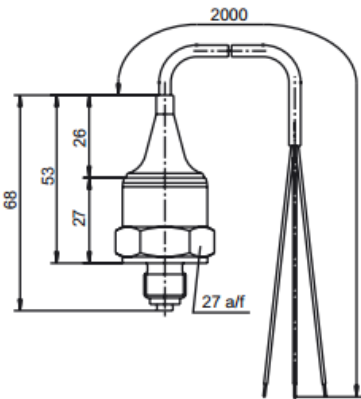

11

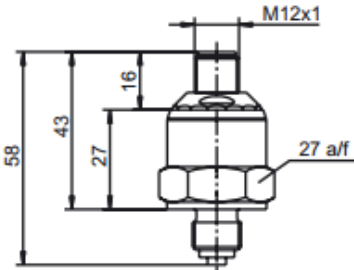

36

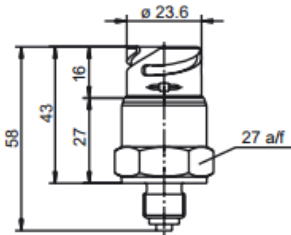

53

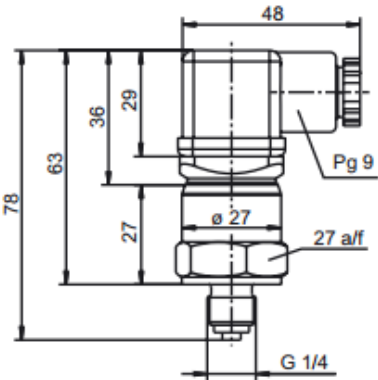

61

Process connections

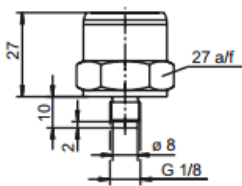

501

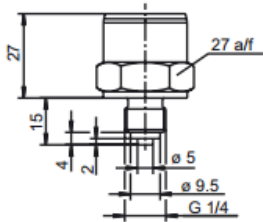

502

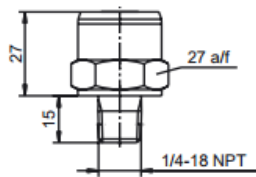

511

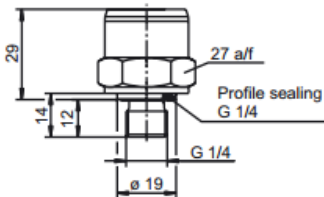

521

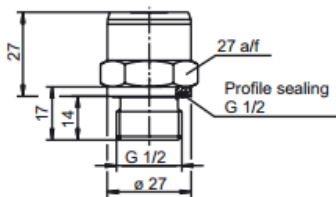

523

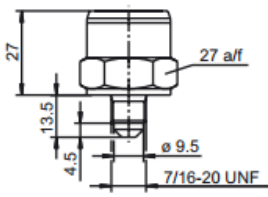

562

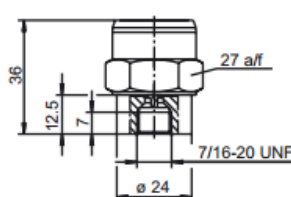

563