

Machine Interface

NA Series



Bringing technology to life

Sysmac - the family that matches every requirement

As part of the Sysmac automation platform, Omron NA HMI transforms machine data into information, shows information and controls devices based on requirements at FA manufacturing sites.

The NA Series enables faster, more efficient control and monitoring.

With a widescreen displaying 16,770,000 colors, the HMI that is dynamic, intuitive and predictive makes industrial machines more attractive and competitive.



NX I/O
NX Safety

FH Vision System

1S AC Servo System

NJ/NX/NY Controller



Integrating your world

The Sysmac Studio is the centerpiece of the Sysmac platform, bringing together all areas of automation including: logic, motion, vision, safety and visualization.

The NA Series can be programmed alongside the other devices in one integrated project, which speeds up development.

ONE Tag Database

- Share NJ/NX/NY Controller Variables (Tags) in the machine interface application.
- Variables shared with controller reduce the time and complexity of programming.
- Define/use NA data structures in the machine interface application

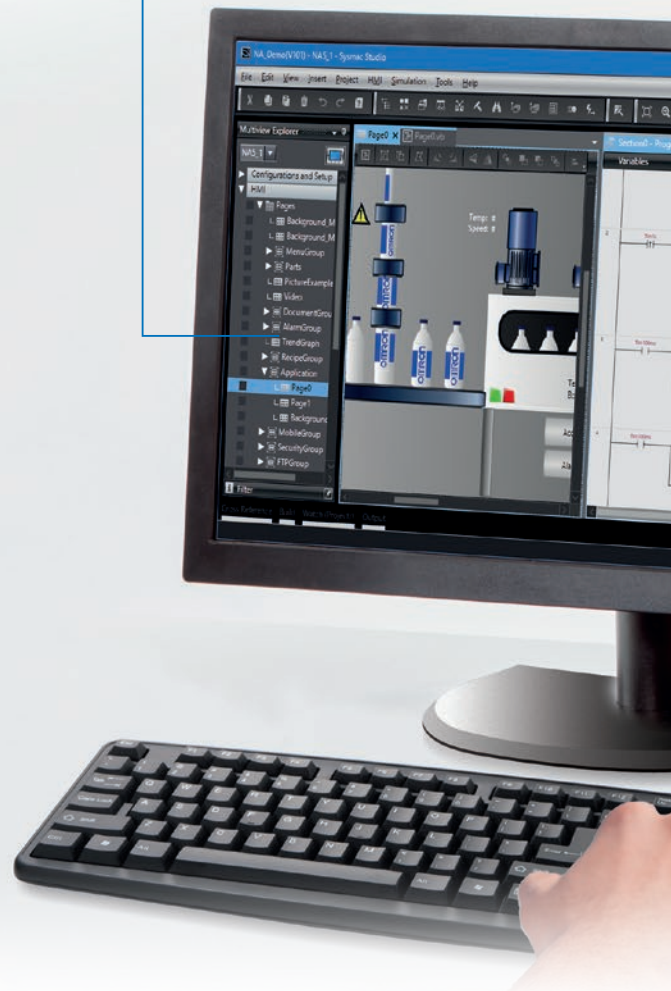

ONE Learning, ONE Project

- Program your controller and safety systems
- Simultaneously program the NA Series as device in Sysmac Studio
- Program your whole machine in one project
- Work in a familiar way on all devices

Editors in ONE

- Display both controller and HMI editors on one screen for quick design.

Safe and secure

- Configure individual users with multi access levels

SIMPLE

- Clearly and quickly define the View
- Quickly change properties, animations, events and actions
- Powerful page editor to group objects
- Rotate, and resize - all with a simple click

BUT STILL FLEXIBLE

- Write your Visual Basic Script
- Extend the possibilities with Visual Basic

Test it in ONE

- Integrated testing through simulation of programs on controller and HMI at the same time. Checking your device operation at the same time makes debugging quicker and easier.
- Quickly test your device operations via the Simulator.

Features for speed

- Structured programming (through One software)
- Network device insight
- Vision setup
- Machine Controller troubleshooting

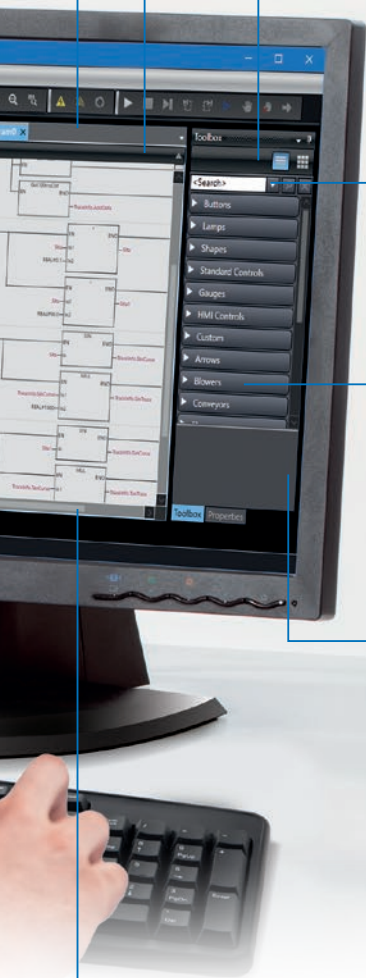

Keep Machine Running - Minimize downtime

If something unexpected happens in your machine, it is crucial to identify the cause and solve the problem quickly. As part of the Sysmac automation platform, the NA Series helps minimize machine downtime.

Troubleshooter

The Troubleshooter on the NA Series allows you to directly monitor and release the NJ/NX/NY Controller errors and events as well as the user-defined errors and events. There is no need for support software running on a PC.



Safety Monitor NEW

The NA Series can directly access safety CPU units and safety I/O units, which was previously impossible. There is no need to create any special screen to monitor their device variables and I/O settings.

The I/O Matrix Monitor displays device variables and external exposed variables used in safety programs, allowing you to see outputs (error state) and corresponding inputs (causal condition).

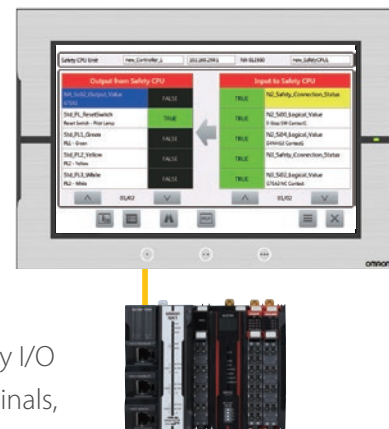

The Safety Input/Output Unit Monitor shows the ON/OFF status of safety I/O units and information on components connected to individual I/O terminals, enabling efficient monitoring of the entire system including safety components.

Safety CPU unit



Safety I/O unit

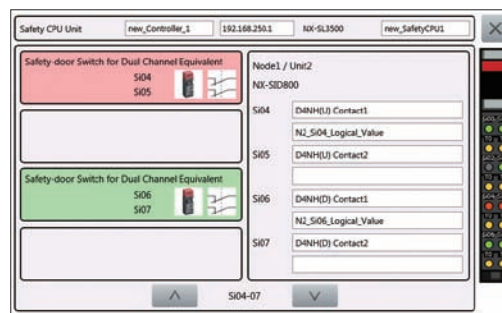

Logging and displaying operations NEW

The system events that the NA Series detects and the operations that operators perform on the HMI can be logged.

The logs can be displayed on the NA Series, and can also be saved as CSV files to display them on your PC.

You can see who and when did what in a chronological order, helping you analyze errors.

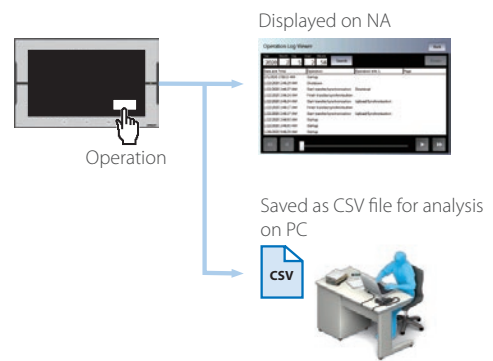

Remote access

- You can view and operate the HMI installed at production sites from your tablet using Ethernet or WiFi.
- The access of remote devices can be managed and limited. This helps prevent accidental operation and information leakage, while securing accessibility.

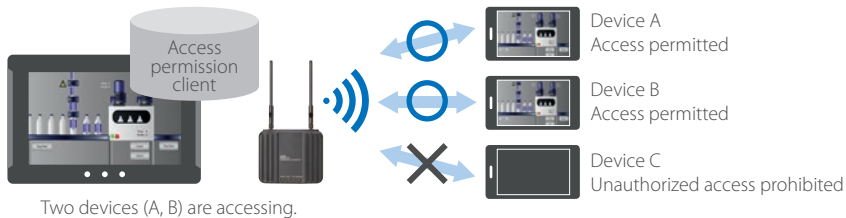

Increased security

The NA Series can be configured to specific staff, with multi access levels with password protection.

This ensures authorised people interact with the machine.



Protecting your assets

- Your project can be password-protected along with other applications (Control and Safety).
- Transferring data can be protected (disable overwrite or theft).

Simple, but Flexible!

The NA Series gives the user the ability to design using IAGs (Intelligent Application Gadgets). IAGs simplify and accelerate the development process through structuring the project and enhancing reuse. From simple graphics to complex objects, you can make your own collections and share them between projects, like a Function Block.

Step 1: Machine Parts, the Visual

Using standard controls, or graphics from the machine parts collection, design your own IAG. Add interface properties and methods to bring the object to life when reused.

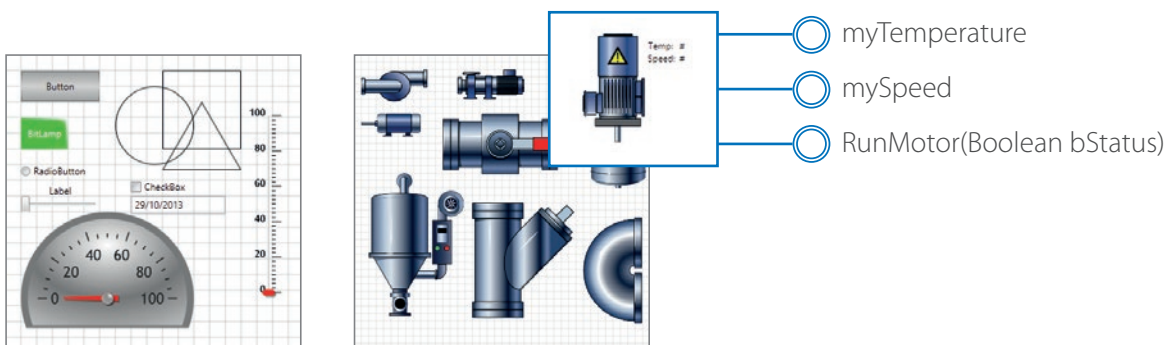

```
'IAG Code behind - Add local subroutines for the IAG.
Public Function RunMotor(bStatus As Boolean) As Double
    'start motor at default speed
    mySpeed = 50
    'return current speed
    RunMotor = 50
End Function

Public Function IncreaseSpeed(nIncrement As Integer) As Double
    ' Increase speed by increment if < 1000
    If mySpeed + nIncrement < 1000 Then
        mySpeed = mySpeed + nIncrement
    Else
        'otherwise set to top speed
        mySpeed = 1000
    End If
    'Return new speed
    IncreaseSpeed = mySpeed
End Function
```

Step 2: Extensible with Visual Basic

As well as many graphic IAGs, it is also possible to embed code within an IAG. The code can extend the possibilities of the gadget such as providing special device communication. Thanks to Visual Basic the standard functionality of the NA can be extended as required.

1

2



3

Step 3: Publish and Share

When the IAG is built and tested (using simulation) it can be published and the collection file distributed to be used again and again. Omron will release further IAG collections to extend the functionality of the NA Series.

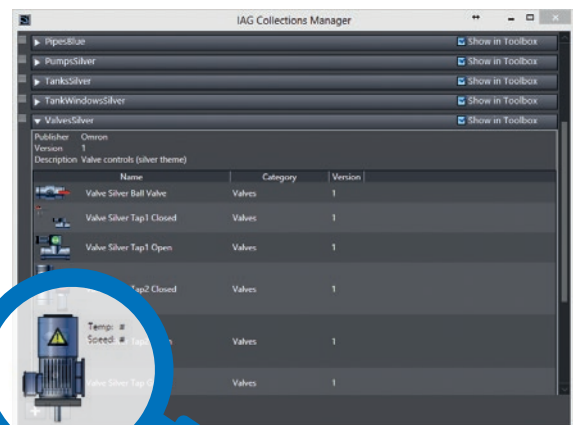

A range of options that covers every need

NA5

Very stylish, very functional

All wide screen models: 7, 9, 12, 15 inch

Black and Silver

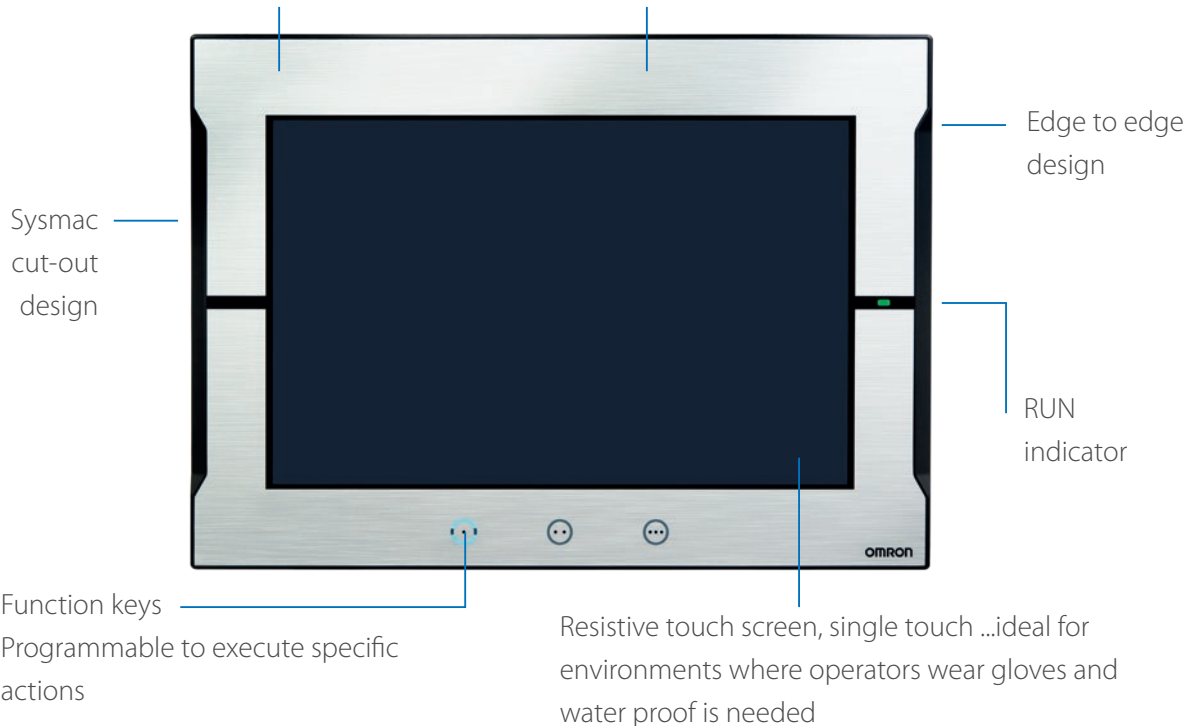

Widescreens displaying 16,770,000 colors



- 16,770,000 display colors (24 bit full colors)
- High-resolution display
1,280 x 800 resolution for 12-inch and 15-inch models
800 x 480 resolution for 7-inch and 9-inch models

Soft-NA NEW

HMI functions work on Windows to flexibly suit various on-site applications

Soft-NA provides equivalent functionality to NA5. This Windows application can be used with a wide variety of hardware including a large monitor and environment-resistant monitor, quickly meeting changing users' needs. Soft-NA runs on an industrial PC or a PC, which allows you to run both your own data collection program and Soft-NA on a PC. Visualization of machine data helps reduce downtime.

Screen data

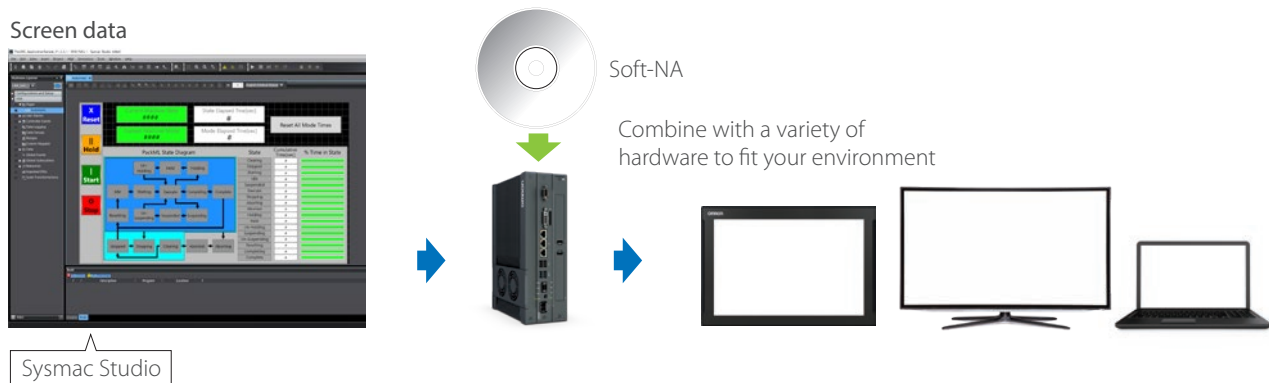

One Software, Sysmac Studio, manages all program assets

The advantages of the integrated development environment, such as sharing NJ/NX Controller variables and integrated Simulator, can be used on Soft-NA. Soft-NA also provides the same NJ/NX Troubleshooter as NA5, assisting in minimizing machine downtime. In addition, if you have screen data for NA5, it can be easily converted into screen data for Soft-NA.

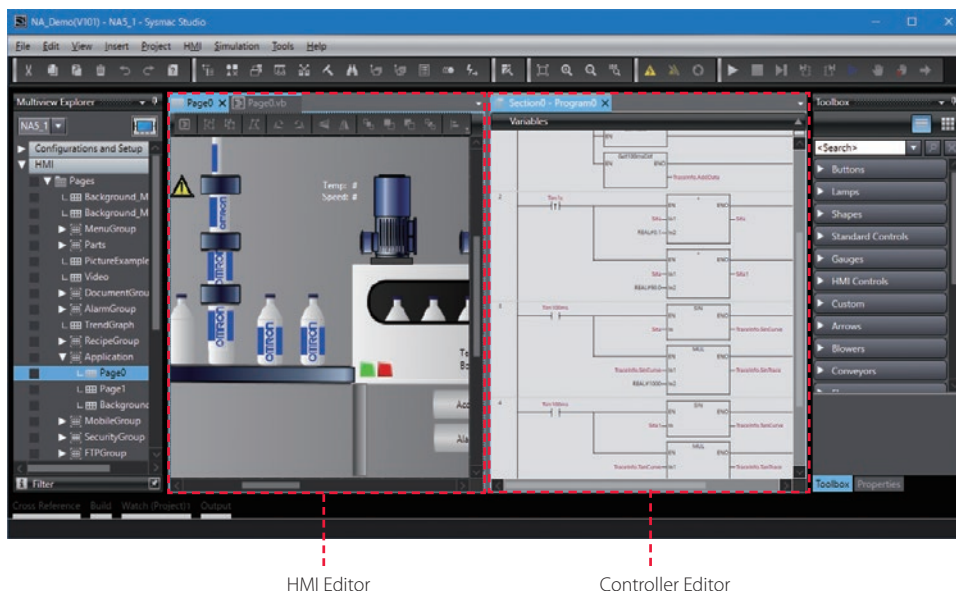

SHOW your machine

- Greater visualization

More than 16 million display colors (24-bit full color)

High-resolution bitmap graphics*1 and 67 different types of fonts can be used to create intuitive and good-looking screens. In addition, DXF files are supported to display CAD data. Even if the drawing is enlarged or reduced in size, it never loses quality.

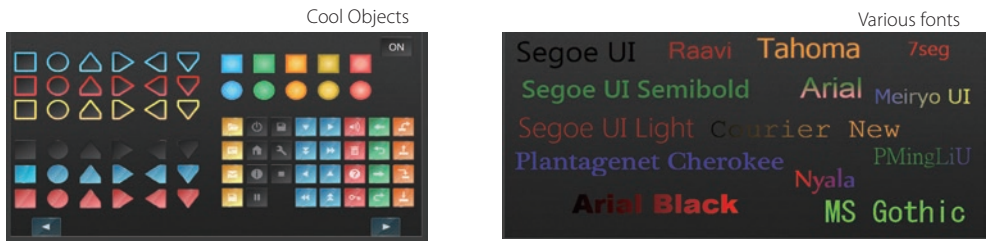

*1.Contact your Omron representative to obtain Cool Objects.

Indirect reference of text strings

A text string that is displayed on a label object (1 line) or a text box object (1 or more lines) can be switched by indirect reference. The machine operating status and alarm details can be easily displayed.

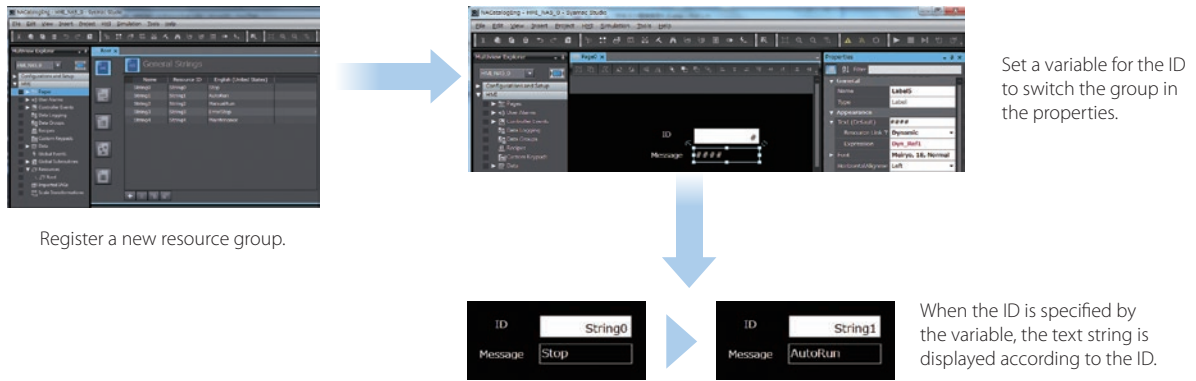

Tab control

A part of the screen can be used like a notepad.

Up to 64 tab pages for a Tab Control object can be created, and up to 10 Tab Control objects can be placed on a screen.

Change a tab page instead of a screen to monitor/change various data.

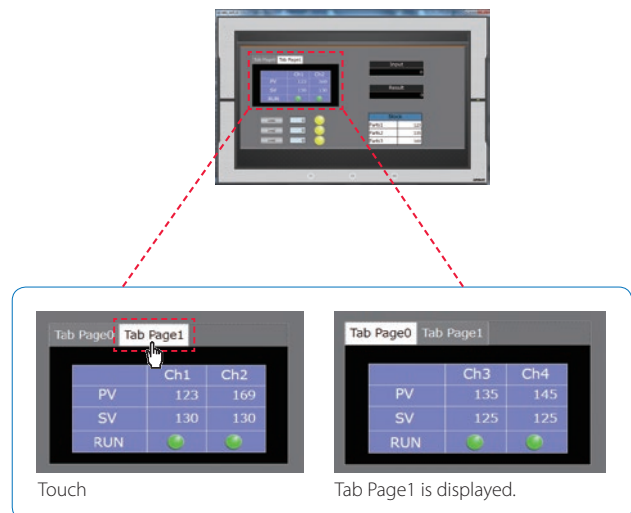

Setting, sorting, and filtering alarms

Alarms can be set easily, reducing time and effort required for creating alarm screens.

Improved User Alarms Viewer

Select an item from the drop-down menu.

The column width and title can be changed.

You can quickly create the desired alarm screens.

Status	Date and Time	Message	Priority	Group
Alarm Raised (acknowledged)	2/24/2016 10:40:10 AM	PLC-PLC Communication fault	Level 2	Machines
Alarm Raised (acknowledged)	2/24/2016 10:40:04 AM	Line3 Emergency Stop	Level 1	Machines
Alarm Raised (acknowledged)	2/24/2016 10:39:59 AM	Battery Error	Level 3	Machines

You can “sort” alarms by the preset item and “filter” by any keyword. The error location can be quickly identified from a large number of alarms.

Sorting

Select either ascending or descending order.

Touch the header to switch between ascending and descending order.

The preset item is used for sorting.

Select the item to sort.

Date and Time	Message	Priority	Information Level
2/24/2016 10:51:33 AM	Setting Error	Level 1	Level 1
2/24/2016 10:51:31 AM	Emergency Stop Button Pressed	Level 1	Level 1
2/24/2016 10:51:29 AM	Communications Error	Level 1	Level 1
2/24/2016 10:51:26 AM	Lift No. 1 Stop	Level 1	Level 1
2/24/2016 10:51:22 AM	Battery Error	Level 3	Level 3

Filtering

Select the fault level to display.

The filtered alarms are displayed.

Date and Time	Message	Priority	Information Level
2/24/2016 10:51:33 AM	Setting Error	Level 1	Level 1
2/24/2016 10:51:29 AM	Communications Error	Level 1	Level 1
2/24/2016 10:51:22 AM	Battery Error	Level 3	Level 3

Scaling

Scaling can be set for Data Display/Data Edit objects and global variables. Values of variables can be converted by specifying conversion expressions, which makes it easy to show data in the controller.

Value of NJ/NX/NY variable: 10,000,000

Not scaled

Scaled by specifying 1/100,000,000

Broken-line graphs

Data of variables and multidimensional arrays in the controller can be displayed as broken-line graphs. Broken-line graphs can also be created from the data in the CSV files saved in the SD card inserted in the NJ/NX/NY Controller by using subroutines (Visual Basic). You can specify the display range of large array data, such as operation log, by setting the offset value.

Multidimensional array

The offset can be specified from the start of the display range.

Graph display range

Increases the compatibility with the controller.

Element No.	Value
0	0.21
1	0.32
2	0.45
3	0.52
4	0.59
5	0.63
6	0.70

OPERATE your machine

- Comfortable to use

Supporting Asian languages

An Asian language - Japanese, simplified Chinese, traditional Chinese, or Korean - can be selected to use in the keypad of the NA Series.

The keypad language changes automatically when the language is changed in the language settings.

Local languages can be used to input the names of products when new recipes of the food packaging machine are added.

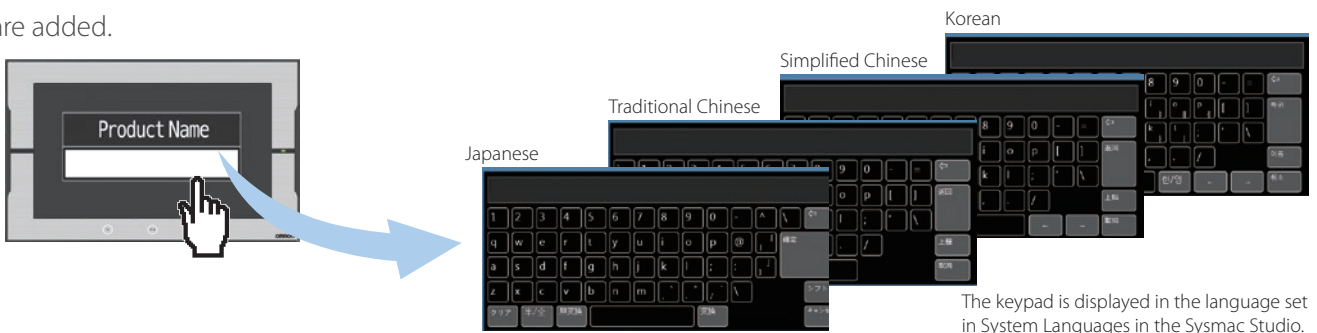

Executing a subroutine with multiple threads

Some subroutines require time due to repeated processing or waiting time.

Even such a subroutine can be executed during screen update, without affecting operability and visibility.

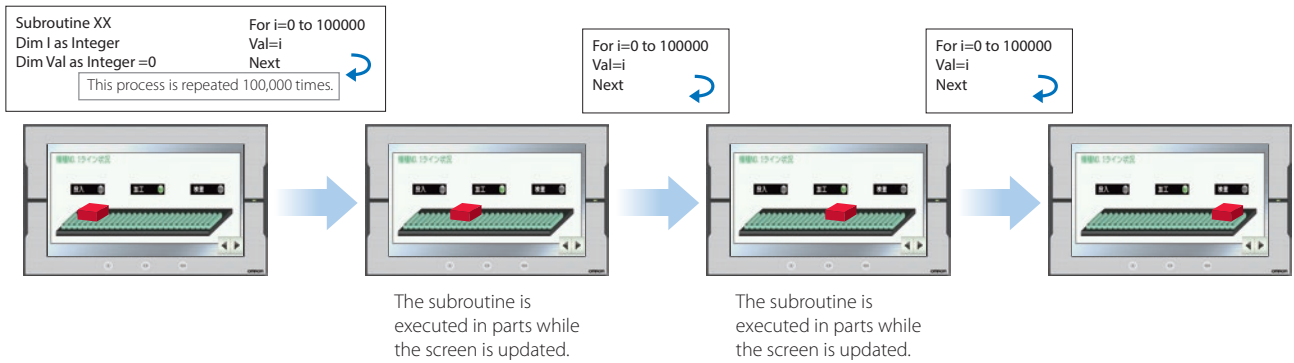

Page jump from user alarm

The page to switch can be specified in each alarm setting.

When an alarm occurs, you can check the troubleshooter screen by selecting the displayed alarm.

Name	Alarm ID	Alarm Code	Expression	Priority	Message	Popup	Acknowledge	Page
A1	Group0_A1		Alarm1=True	User Fault Level 1	Alarm1	<input type="checkbox"/>	<input type="checkbox"/>	Page6
A2	Group0_A2		Alarm2=True	User Fault Level 1	Alarm2	<input type="checkbox"/>	<input type="checkbox"/>	Page5
A3	Group0_A3		Alarm3=True	User Fault Level 1	Alarm3	<input type="checkbox"/>	<input type="checkbox"/>	Page4
A4	Group0_A4		Alarm4=True	User Fault Level 1	Alarm4	<input type="checkbox"/>	<input type="checkbox"/>	Page3
A5	Group0_A5		Alarm5=True	User Fault Level 1	Alarm5	<input type="checkbox"/>	<input type="checkbox"/>	Page2

The page to switch can be specified in each alarm setting.

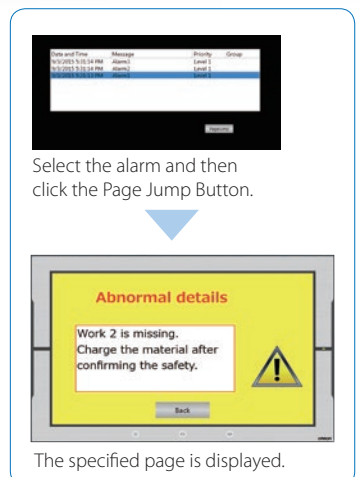

Customizing keypads and resizing objects

You can change the keypad size, choose only the keys you need, and customize the keys to execute specified actions. Create your own keypad suitable for your applications.

The size of the Check Box, Slider, and Radio Button objects can also be changed. You can greatly improve the usability of your machine by enlarging these objects in size.

■ Custom keypads

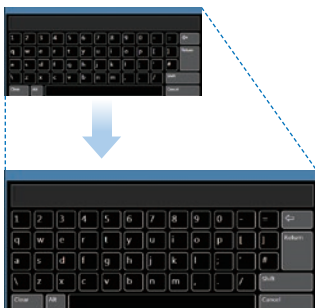

Changing the keypad size
The size can be changed to suit the user's needs.

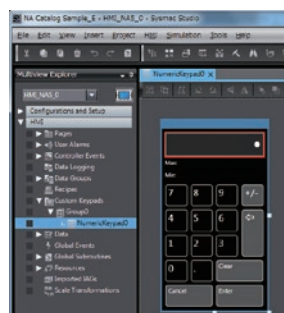

Creating user's own keypad
Only the keys the user needs can be chosen, and the keys to execute specified actions can be customized.

■ Resizing object

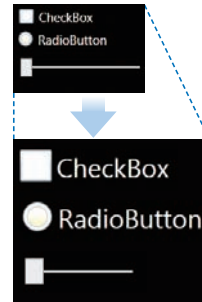

Resizing objects
The properties of the object size are added. You can resize the objects suitable for your application.

Dynamically changing upper/lower limit value

The upper and lower limit values can be dynamically changed by setting variables as maximum and minimum values of a Data Edit object. It is possible to restrict input according to the status of the machine.

Set variables as minimum and maximum values

Behavior	
IsEnabled	<input checked="" type="checkbox"/>
Data Type	Numeric
Variable	NA_NumData1
Scaling	
Minimum Value	Min_Data
Maximum Value	Max_Data
Value Format	Decimal

Max:	80
Min:	50

You can easily restrict input on the HMI or from the PLC.

Specifying a page number

By assigning any number to the page, you can easily switch pages from the PLC.

The previously required subroutine is no longer needed for this operation. This feature is particularly helpful when you use the CJ PLC in which pages are frequently specified by number.*1

General	
Name	Page0
Type	Page
PageIndex	10

Set the number you want to assign to the page.

No.10

No.11

No.12

To jump to the specified page, enter the number, which corresponds to the page number, in the `_HMI_CurrentPageIndex` system-related variable.

*1. This function is also supported in the NJ/NX/NY Series.

Usability: Design

- Simple screen design

Integrated development environment

Sharing data between the NA Series and the NJ/NX/NY Series in real time on the Sysmac Studio increases design productivity.

Displaying editors on one screen

The NA HMI Editor and NJ/NX/NY Controller Editor can be displayed on one screen.

This eliminates the need to switch between screens, making the design easier and faster.

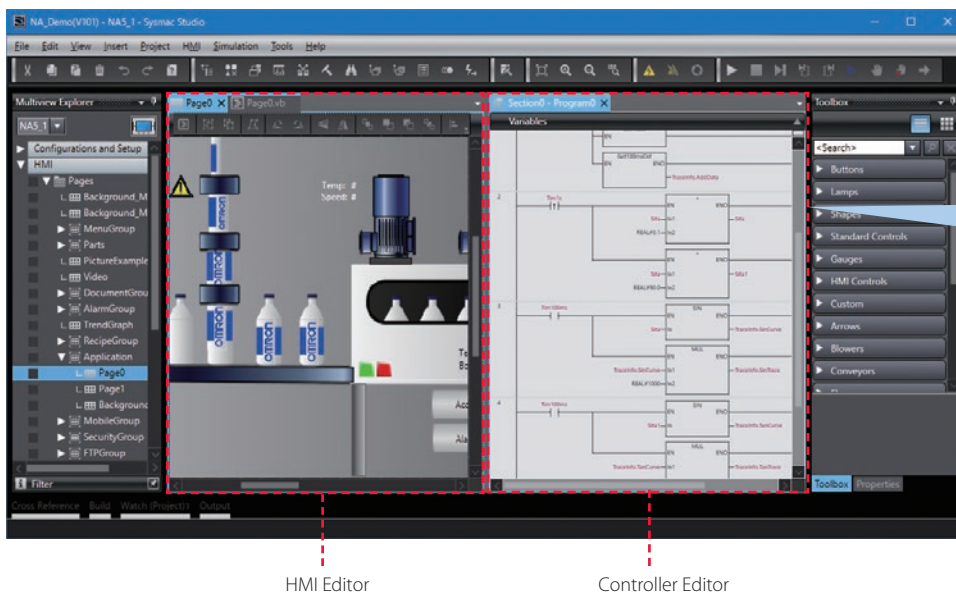

Concurrent development of ladder and HMI

Device data of the NA Series can be imported from and exported to the project file.

When the controller designer and HMI designer develop a machine concurrently, the screen data can be merged with the controller project.

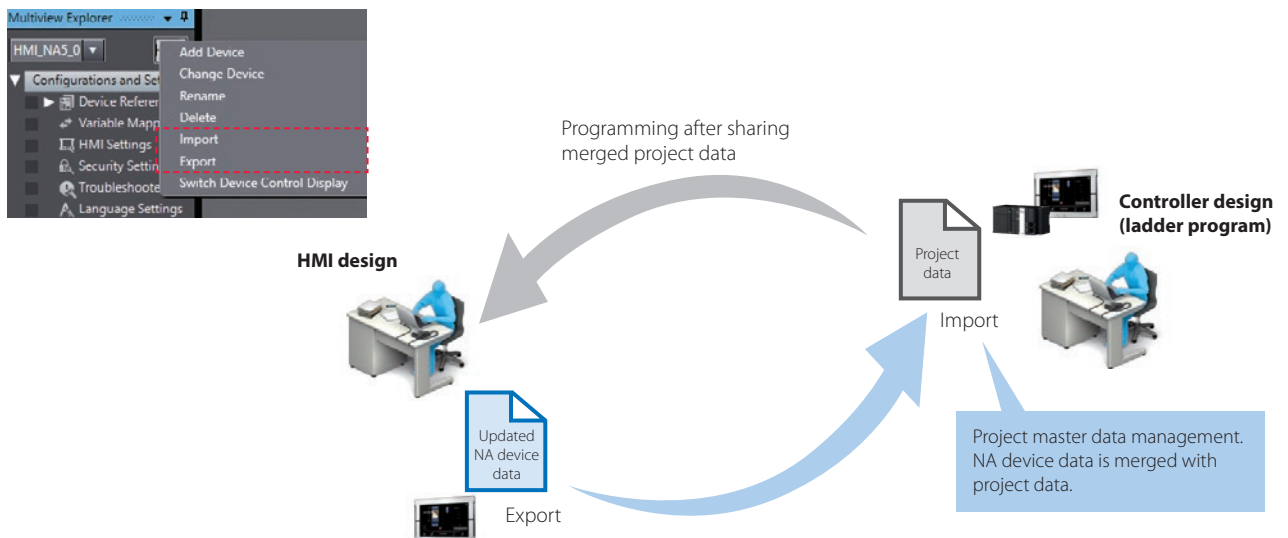

Adding an object by drag & drop

Just drag a variable from the Ladder Editor in the NA Page Editor to add an object. The variable is automatically set in the property of the added object.*

This eliminates the need to create and allocate HMI variables, which facilitates design work.

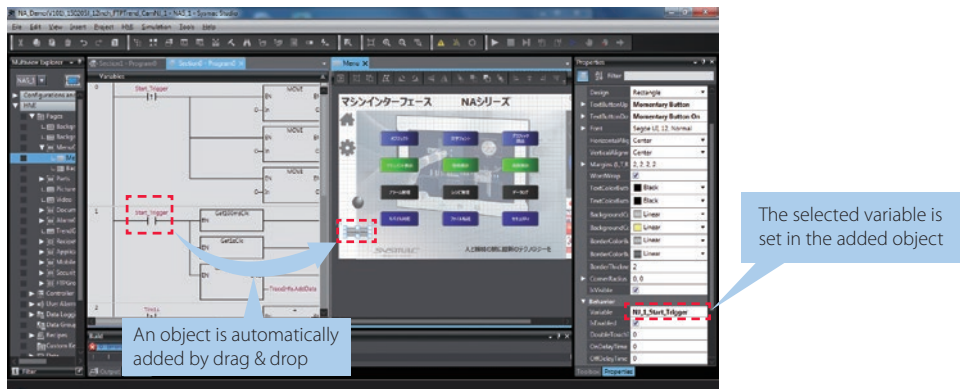

* When an input is selected, a Button object is added automatically.
When an output is selected, a Lamp object is added automatically.

Improved mapping of controller variables to NA Series

- NJ/NX/NY Controller variables can be automatically mapped to the NA HMI. This improves design efficiency and ensures that all added variables are mapped.
- The device name generation rule can be customized in manual mapping. Variables can be mapped according to your desired rule.

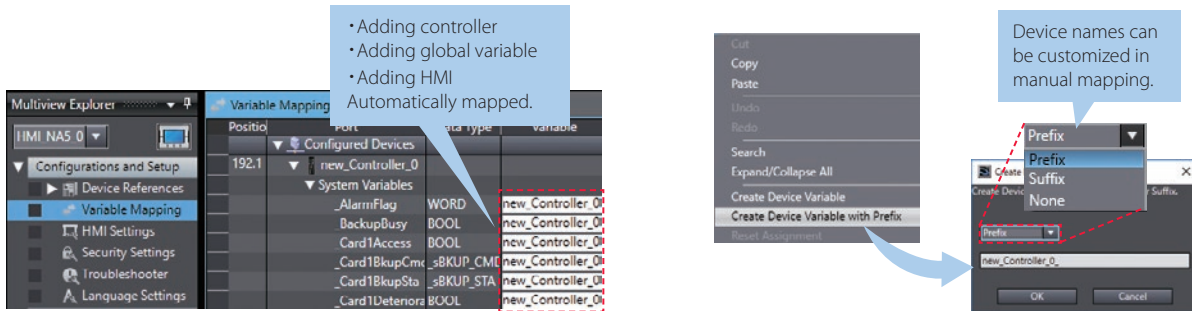

Easy to add NA variables to controller

Variables added to the NA HMI can be registered and mapped to the controller variable table from the properties for objects or the NA global variable table.

Going back to the controller global variable table to add variables is no longer required, saving your design time.

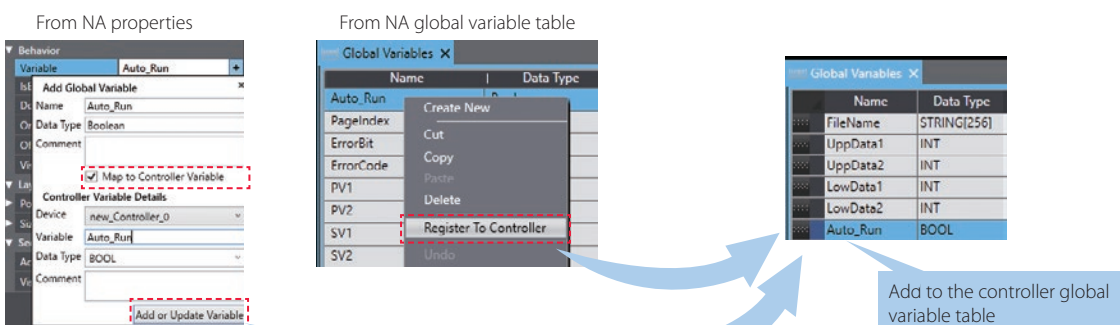

Resource management

Helps install your machines globally and modularize design.

Language Settings

- Different fonts, sizes, and styles can be set for different languages. You can use your specified fonts or fonts suitable for local languages. Also the font of a specified object can be changed according to language.
- The default language can be changed. Properties and alarm groups, as well as screens, are displayed in local language, which makes design faster and easier.

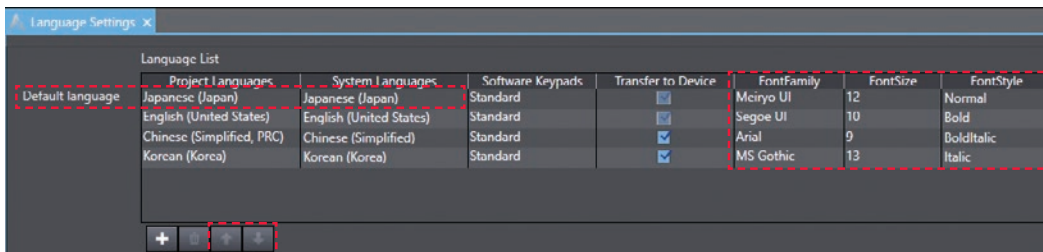

Different fonts can be set for different languages.

Select the default language by clicking the ↑ or ↓ Button.

The font of the specified object can be changed.

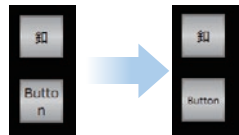

Font	Japanese (Japan)	Meiryo UI, 12, Normal
Family	Meiryo UI	
Size	12	
Style	Normal	
English (United States)	Segoe UI, 10, Normal	
Family	Segoe UI	
Size	10	
Style	Normal	
Chinese (Simplified, PRC)	Arial, 9, BoldItalic	
Korean (Korea)	MS Gothic, 13, Italic	

Improved user alarm editing

- User alarms can be exported to and imported from Excel with the same layout as the user alarm table. The table can be sorted or filtered in Excel.
- Both the message and its details are exported to and imported from Excel. They are sorted according to the alarm ID, allowing you to edit text strings while you view all information.

Name	Alarm ID	Alarm Code	Expression	Priority	Message	Popup	Acknowledge	Page	Details
Alm1	Group0_Alm1	123	Var1	User Fault Level 1	Message1	<input checked="" type="checkbox"/>	<input checked="" type="checkbox"/>	Page0	Detail1
Alm2	Group0_Alm2	999	Var2	User Information	Message2	<input checked="" type="checkbox"/>	<input checked="" type="checkbox"/>	Page1	Detail2

The table with the same layout as the alarm table can be edited efficiently.

	A	B	C	D	E	F	G	H	I	J	K	L
1	Group Name 1	Group Name 2	Group Name 3	Alarm ID	Alarm Code	Expression	Priority	Message	Popup	Acknowledge	Page	Details
2	Group0			Group0_Alm1	123	Var1	UserFaultLevel1	AString0	True	True	Page0	AString1
3	Group0			Group0_Alm2	999	Var2	UserInformation	AString2	True	True	Page1	AString3

The list of all alarm information can be edited.

	A	B	C	D	E	F
1	Alarm ID	Type	Resource Group Name	Resource ID	English (United States) [en-US]	Japanese (Japan) [ja-JP]
2	Group0_Alm1	Message	[root]	AString0	Message1	メッセージ1
3	Group0_Alm1	Details	[root]	AString1	Detail1	詳細1
4	Group0_Alm2	Message	[root]	AString2	Message2	メッセージ2
5	Group0_Alm2	Details	[root]	AString3	Detail2	詳細2

You can edit both the messages and details in all languages on the same sheet.

- Even if alarms are grouped, such as by machine module, all alarms can be imported and exported at once.

Improved resource editing

- In addition to entering a text string directly in properties, you can assign an ID first and enter a text string later. This resource ID-based management enables you to standardize screens first and then enter all text strings edited in Excel to suit machine specifications.

Standardized screen master data

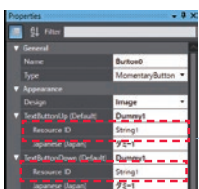

Enter only the ID in the properties.

Edit text strings in Excel during machine design

Name	Resource ID	English (United States)	Resource (Japan)
String0	String0	Dummy0	ダミー0
String1	String1	Dummy1	ダミー1
String2	String2	Dummy2	ダミー2
String3	String3	Dummy3	ダミー3
String4	String4	Dummy4	ダミー4

Fixedness Temporary input

Group Name	Resource ID	English (United States) [en-US]	Japanese (Japan) [ja-JP]
1	String0	Machine_A_ON/OFF	装置AのON/OFF回数
2	String1	Machine_A_Communication Time	装置Aの通信時間
3	String2	Machine_A_Energized Time	装置Aの通電時間
4	String3	Machine_A_Ambient Temperature	装置Aの周辺温度
5	String4	Machine_A_Voltage	装置Aの電圧値

Screen data according to machine specifications



Import to change

Name	Resource ID	English (United States)	Japanese (Japan)
String0	String0	Machine_A_ON/OFF	装置AのON/OFF回数
String1	String1	Machine_A_Communication Time	装置Aの通信時間
String2	String2	Machine_A_Energized Time	装置Aの通電時間
String3	String3	Machine_A_Ambient Temperature	装置Aの周辺温度
String4	String4	Machine_A_Voltage	装置Aの電圧値

- Even if resources are grouped, such as by machine module, all resources can be imported and exported at once.
- Object properties (e.g., variables and expressions of buttons and lamps, resource IDs, text strings) in all languages on the same page can be imported and exported. Multiple properties can be edited at once in Excel, making resource editing easier, faster, and more precise.

Standardized screen layout



Copy

Efficiently add pages of the same layout



Page Name	Object Name	Property Name	Setting
Page0	Label0	Text	String25
Page0	Button0	Text	String32
Page0	Button0	TextOn	String32
Page0	Button0	FeedbackExpression	

Change multiple variables and resource IDs at once.

Change multiple text strings in different languages at once.

Page Name	Object Name	Property Name	Resource Group Name	Resource ID	英語 (米国) [en-US]	日本語 (日本) [ja-JP]
Page0	Label0	Text	[root]	String25	Machine_A	装置A
Page0	Button0	Text	[root]	String32	Self-Diagnosis	自己診断
Page0	Button0	TextOn	[root]	String32	Self-Diagnosis	自己診断

Page Editor

Provides a simple GUI and a full suite of functionality to assist and streamline the design process.

Importing and exporting pages NEW

Pages can be saved as library files and reused individually in other projects.

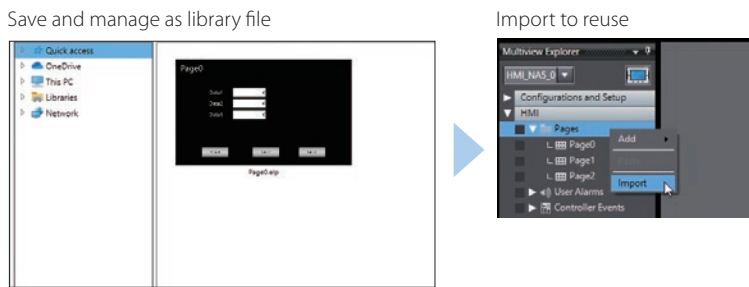

Changing type of button

The type of the Buttons including Set and Momentary can be changed easily in the properties whenever you want, even during or after designing the Button.

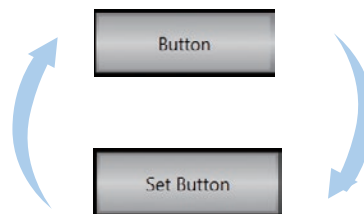
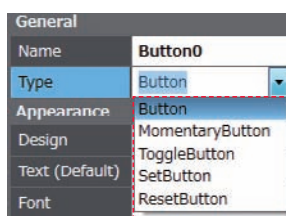

No need to recreate the button to change its type. The settings will be maintained even the type has been changed, reducing the amount of work required for screen creation.

Buttons with the lamp function

You can easily create Buttons with the lamp function.

Types of Buttons with the lamp function

Setting	Condition for lightning lamps
Touch(Button)	Pressing Button
Variable(Button)	Variable
Feedback(Button)	Feedback Expression
Touch(Button) + Feedback(Button)	Pressing Button + Feedback Expression
Touch(Button) + Feedback(Indicator)	Button: Pressing Button Indicator: Feedback Expression
Variable(Button) + Feedback(Indicator)	Button: Variable Indicator: Feedback Expression

Example

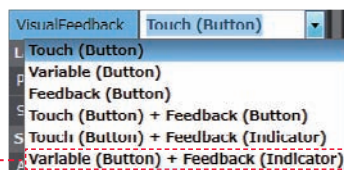

Conceptual figure for setting objects

Variable	NA_BitData1
IsEnabled	<input checked="" type="checkbox"/>
DoubleTouchTime	0
DelayTime	0
Visual feedback	Variable (Button) + Feedback (Indicator)
FeedbackExpression	NA_NumData2 >= 2

One object that has both button and lamp functions can be created. This eliminates the need for creating multiple objects, helping create screens faster.



A lamp (indicator) can be set on a button.

Data input order

The data input order can be set. When numeric values are entered consecutively, the focus automatically moves to the next Data Edit object by touching the Enter key. Input errors and input time can be minimized.

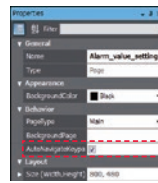

Enable AutoNavigateKeypads in the properties of the page to enter data consecutively.

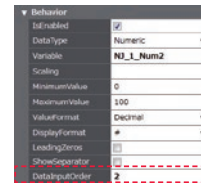

The data input order can be set in the property of the Data Edit object.



The focus automatically moves to the next object by touching the Enter key.

Creating duplicate objects

Based on one object, you can create multiple copies with the same appearance and settings by specifying an off set value for an array variable. This makes screen creation faster and easier.

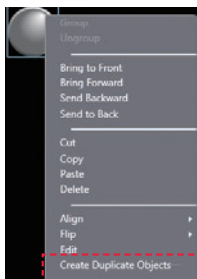

Right-click



Set the number of horizontal and vertical objects, and their spacing. When an array variable is specified, you can duplicate the object by adding the specified offset value to the element number.

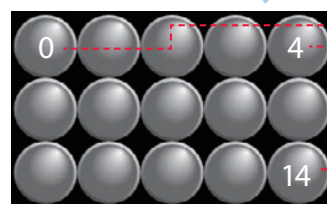

Behavior
Expression **DuplicateSample(0)**

Behavior
Expression **DuplicateSample(4)**

Behavior
Expression **DuplicateSample(14)**

NA screen capture

The screens displayed on the NA Series can be captured and saved in the SD card inserted in the NA Series or the USB memory connected to the NA Series.

- When a screen of the NA Series is required to create a machine operation manual
- When the current screen is required to save as proof of a trouble

Supported format: PNG

The combination of VNC and FTP allows you to capture the NA screens from the connected PC.

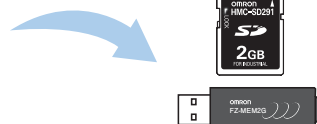

Usability: Debugging

- Easy and fast debugging in integrated development environment

Integrated Simulator

The NJ/NX/NY Controller Simulator and NA HMI Simulator can be displayed on one screen. You can quickly debug the controller program and the HMI application at the same time.

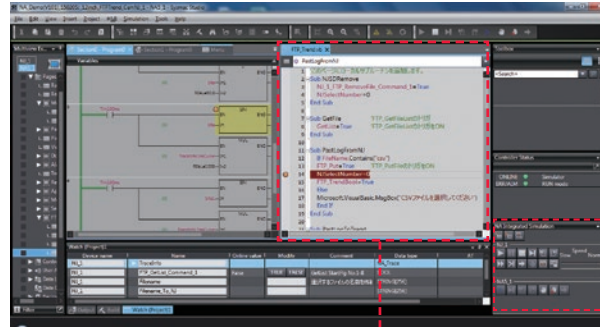

Operations, such as stop and step execution, can be performed for both HMI and controller simulations.

Switchable to the screen for desing.

- You can display the selected page and change properties without stopping the Simulator. Immediate debugging during simulation before building will prevent you from forgetting to correct errors and reduce the frequency of building.

Pages and languages can be changed anytime.

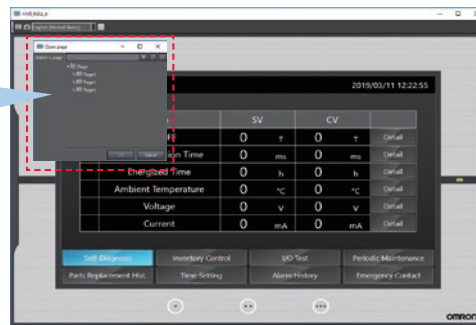

Errors found during simulation can be corrected immediately.



Watch Tab Page

The same GUI as the NJ/NX/NY Controller is used. Register the variable to monitor/change and then change its value on the Watch Tab Page to easily debug screens with the NA Simulator without the physical HMI.

Name	Online value	Modify	Comment	Data type	AI	Display format
NJ_1_ALM1	True	TRUE FALSE		Boolean	NJ_1_ALM1	Boolean
NJ_1_ALM2	False	TRUE FALSE		Boolean	NJ_1_ALM2	Boolean
NJ_1_Lamp	True	TRUE FALSE		Boolean	NJ_1_Lamp	Boolean
NJ_1_Start	False	TRUE FALSE		Boolean	NJ_1_Start	Boolean
NJ_1_Num1	123	123		Short	NJ_1_Num1	Decimal

Change to TRUE

Check the alarm with the Simulator



Cross references

The same GUI for the cross reference function as the NJ/NX/NY Controller can be used.

When a variable is clicked in the global variable table, a list of the locations where the variable is used is displayed in the Cross Reference Tab Page.

By clicking the location, you can access the object, subroutine, or ladder program where the variable is used across the entire project. This makes screen design and debugging quicker and easier.

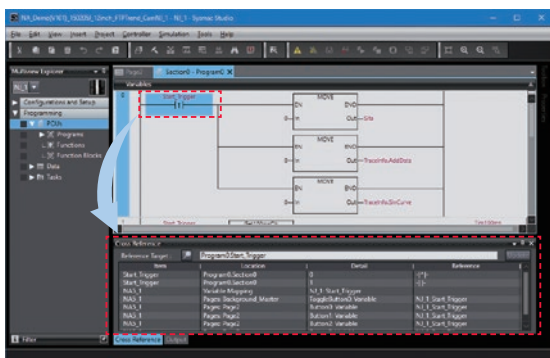

Click the variable in the global variable table to show a list of the locations where the variable is used in the Cross Reference Tab Page.

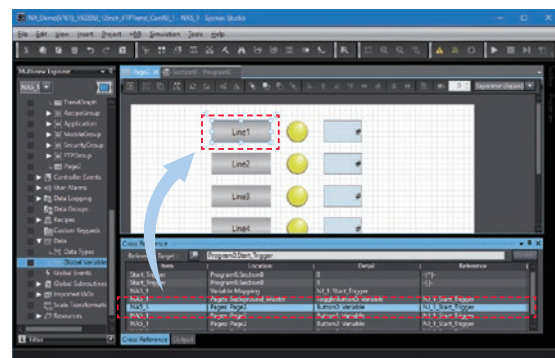

Click the location to access the object where the variables is used.

Search and Replace

You can search and replace text strings in all subroutines (Visual Basic), objects, and variables within a project.

It is quick and easy to edit and debug variable names and switch labels.

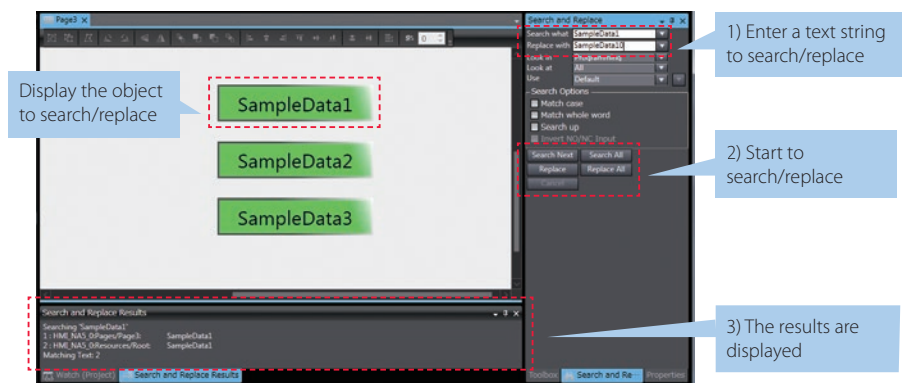

Programmable Terminal NA series

Bringing technology to life

The NA-series Programmable Terminal transforms machine data into information, shows information and controls devices based on requirements at FA manufacturing sites.

The NA Series, together with the NJ/NX/NY-series Controller and the Automation Software Sysmac Studio, allows you to simply and flexibly create sophisticated user interfaces to suit your machines.

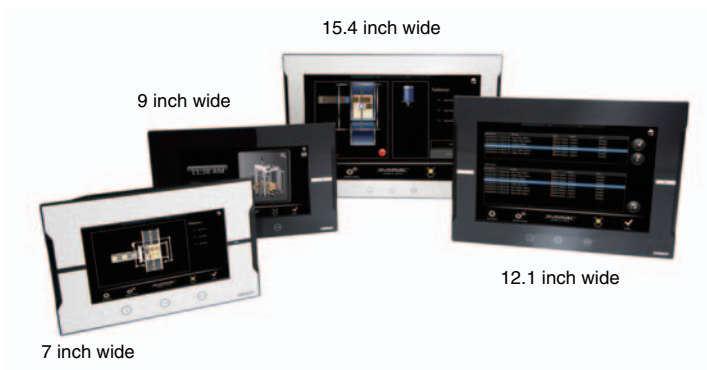

Features

- Widescreen in all models: 7, 9, 12, and 15 inches
- More than 16 million color display for all models and 1280 x 800 high resolution display for the 12 and 15-inch models
- Multimedia including video and PDF *1
- 2 Ethernet ports capable of simultaneous access from both the control device and maintenance segments by separating the segments
- Sysmac Studio providing an Integrated Development Environment
 - NJ/NX/NY variables sharing in the NA project and NA application testing with the NJ/NX/NY program via the Simulator to reduce development time
- Many security features including operation authority settings and execution restrictions with IDs
- Microsoft Visual Basic for versatile, flexible and advanced programming
- Software providing NA5-equivalent functionality on a PC or panel PC

*1. Version 1.5 or higher of pdf file is not supported.

System configuration

NA5

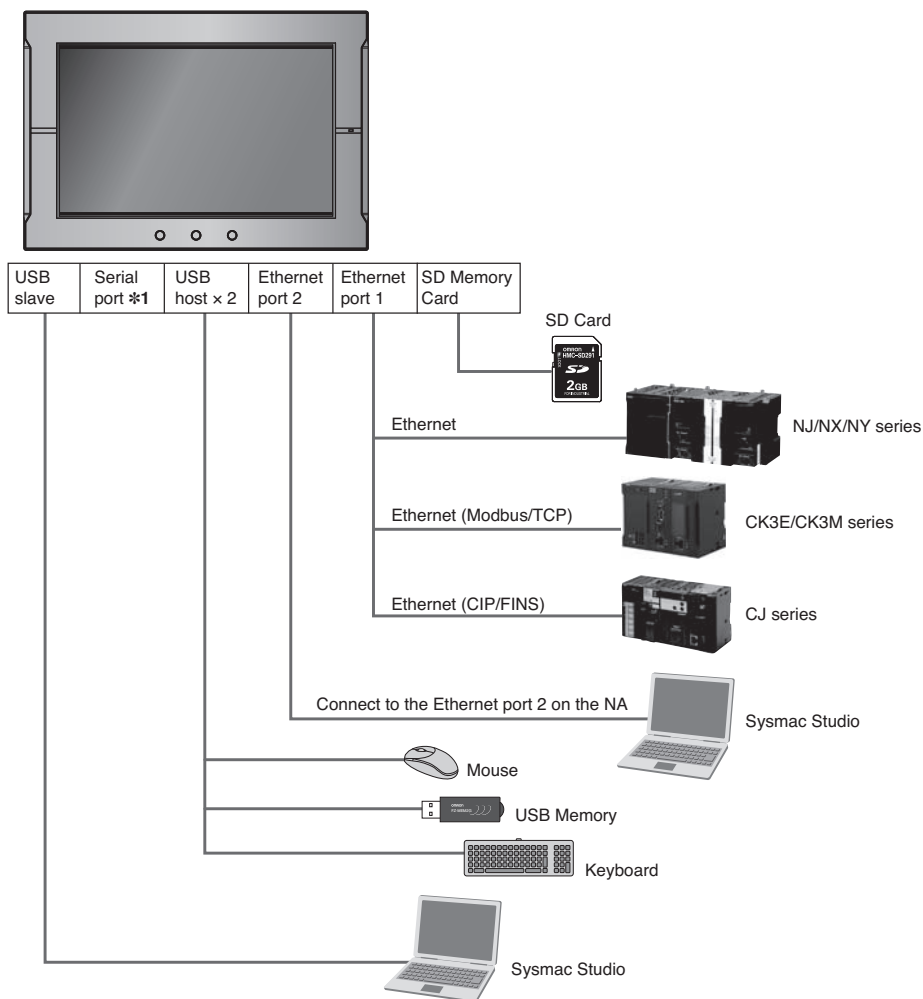

*1. The serial port is for future expansion.

Soft-NA

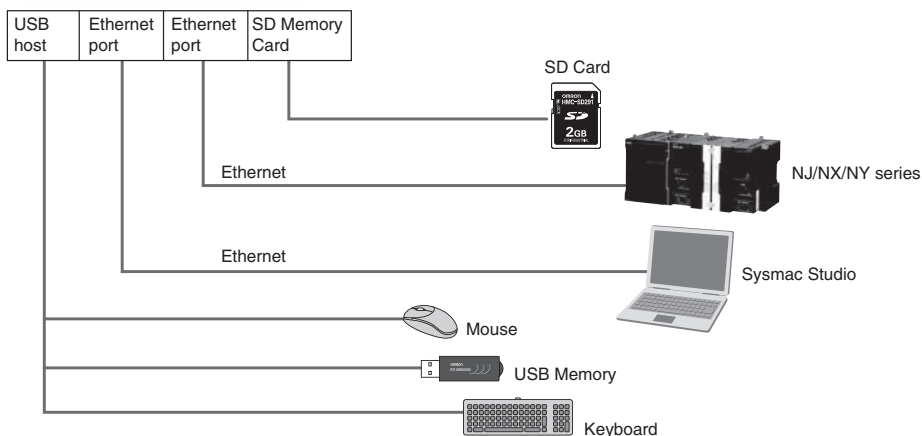

NA series

Ordering Information

NA5-□W

Product name	Specifications	Model #1
NA5-15W	15.4 inch wide screen, TFT LCD, 16,770,000 colors (24 bit full color), 1280 × 800 dots, Frame color : Silver	NA5-15W101S-V1
	15.4 inch wide screen, TFT LCD, 16,770,000 colors (24 bit full color), 1280 × 800 dots, Frame color : Black	NA5-15W101B-V1
NA5-12W	12.1 inch wide screen, TFT LCD, 16,770,000 colors (24 bit full color), 1280 × 800 dots, Frame color : Silver	NA5-12W101S-V1
	12.1 inch wide screen, TFT LCD, 16,770,000 colors (24 bit full color), 1280 × 800 dots, Frame color : Black	NA5-12W101B-V1
NA5-9W	9 inch wide screen, TFT LCD, 16,770,000 colors (24 bit full color), 800 × 480 dots, Frame color : Silver	NA5-9W001S-V1
	9 inch wide screen, TFT LCD, 16,770,000 colors (24 bit full color), 800 × 480 dots, Frame color : Black	NA5-9W001B-V1
NA5-7W	7 inch wide screen, TFT LCD, 16,770,000 colors (24 bit full color), 800 × 480 dots, Frame color : Silver	NA5-7W001S-V1
	7 inch wide screen, TFT LCD, 16,770,000 colors (24 bit full color), 800 × 480 dots, Frame color : Black	NA5-7W001B-V1
High-pressure Waterproof Attachment	This metal frame is for high-pressure waterproofing. Install it to conform to UL Type 4X standards. UL Type 4X is the rating for high-pressure wash-down applications with a flow rate of 246 liter/min.	NA-15WATW01
		NA-12WATW01
		NA-9WATW01
		NA-7WATW01

Options

Product name	Specifications	Model
SD memory card	2 GB	HMC-SD292
	4 GB	HMC-SD492
	16 GB	HMC-SD1A2
USB Memory	2 GB	FZ-MEM2G
	8 GB	FZ-MEM8G
Replacement Battery	Battery life: 5 years (at 25°C). This Battery is provided as an accessory.	CJ1W-BAT01
Anti-reflection Sheets	For the NA5-15W. Attach a Sheet to the screen to protect against diffused reflections and dirt. The entire Sheet is colorless and transparent. Five Sheets are provided in one set.	NA-15WKBA04
	For the NA5-12W. Attach a Sheet to the screen to protect against diffused reflections and dirt. The entire Sheet is colorless and transparent. Five Sheets are provided in one set.	NA-12WKBA04
	For the NA5-9W. Attach a Sheet to the screen to protect against diffused reflections and dirt. The entire Sheet is colorless and transparent. Five Sheets are provided in one set.	NA-9WKBA04
	For the NA5-7W. Attach a Sheet to the screen to protect against diffused reflections and dirt. The entire Sheet is colorless and transparent. Five Sheets are provided in one set.	NA-7WKBA04

Soft-NA

Product name	Specifications	Number of licenses	Media	Model
Soft-NA	The Soft-NA is software that displays information on FA manufacturing sites while providing safety, reliability, and maintainability as an industrial display on which operations can be performed as necessary. The Soft-NA runs on the following OS: Windows 10 Pro Version 1903 or later 64 bit	- (Media only)	DVD	NA-RTSM
		1 license	USB dongle	NA-RTL01
		3 licenses		NA-RTL03
		10 licenses		NA-RTL010

System Requirements

Item	Requirement	
OS	Windows 10 Pro Version 1903 or later 64 bit	
Processor	Intel Atom® x5-E3940 equivalent or higher processor	
RAM	4 GB or more	
Free space in the hard drive necessary for installation	1 GB or more	
Optical disk drive	DVD-ROM drive	
Communication port	USB	USB2.0 Type-A x 2 *1
	LAN	Ethernet x 2 *1

*1. Since one port is for project transfer, it is not required unless the corresponding path is used.

Automation Software

Product name	Specifications	Number of licenses	Media	Model
Sysmac Studio Standard Edition Ver.1.□□	The Sysmac Studio is the software that provides an integrated environment for setting, programming, debugging and maintenance of machine automation controllers including the NJ/NX Series, EtherCAT Slave, and the HMI. Sysmac Studio runs on the following OS. *1 Windows XP (Service Pack 3 or higher, 32-bit version) / Windows Vista (32-bit version) / Windows 7 (32-bit/64-bit version) / Windows 8 (32-bit/64-bit version) / Windows 8.1 (32-bit/64-bit version) / Windows 10 (32-bit/64-bit version) / Windows 11 (64-bit version)	– (Media only)	Sysmac Studio (32-bit) DVD	SYSMAC-SE200D
		– (Media only)	Sysmac Studio (64-bit) DVD	SYSMAC-SE200D-64
		1 license	–	SYSMAC-SE201L
		3 licenses		SYSMAC-SE203L
		10 licenses		SYSMAC-SE210L
		30 licenses		SYSMAC-SE230L
50 licenses	SYSMAC-SE250L			

Note: 1. Site licenses are available for users who will run Sysmac Studio on multiple computers. Ask your OMRON sales representative for details.
*1. Model "SYSMAC-SE200D-64" runs on Windows 10 (64 bit) or higher.

USB Cable

Product name	Specifications
USB Cable	Use commercially available USB cable. Specifications: USB 2.0 cable (A connector - B connector), 5.0 m max.

Recommended Network Devices

Industrial Switching Hubs

Product name	Functions	No. of ports	Accessories	Current consumption (A)	Model
Industrial Switching Hubs	Quality of Service (QoS): EtherNet/IP control data priority 10/100BASE-TX, Auto-Negotiation	5	Power supply connector	0.07	W4S1-05D

Recommended Ethernet Communications Cables

Use STP (shielded twisted-pair) cable of category 5 or higher

Product name	Recommended manufacturer	Model
Wire Gauge and Number of Pairs: AWG24, 4-pair Cable	Cables	Hitachi Metals, Ltd NETSTAR-C5E SAB 0.5 × 4P CP
		Kuramo Electric Co. KETH-SB
	RJ45 Connectors	Panduit Corporation MPS588

Note: 1. We recommend you to use above cable and RJ45 Connectors together.

NA series

Performance Specifications

Display

Item	Specification				
	NA5-15W	NA5-12W	NA5-9W	NA5-7W	
Display panel *1	Display device	TFT LCD			
	Screen size	15.4 inches	12.1 inches	9.0 inches	7.0 inches
	Resolution	1,280 × 800 dots (horizontal × vertical)		800 × 480 dots (horizontal × vertical)	
	Colors	16,770,000 colors (24 bit full colors)			
	Effective display area	331 × 207 mm (horizontal × vertical)	261 × 163 mm (horizontal × vertical)	197 × 118 mm (horizontal × vertical)	152 × 91 mm (horizontal × vertical)
View angles	Left: 60°, Right: 60°, Top: 60°, Bottom: 60°				
Backlight *2	Life	50,000 hours min. *3			
	Brightness adjustment	200 levels			
	Type	LED			
Front panel indicators *4	RUN	Lit green: Normal operation		Lit red: Error	

*1. There may be some defective pixels in the display. This is not a fault as long as the numbers of defective light and dark pixels fall within the following standard ranges.

Model	Standard range
NA5-15W□□□□-V1 NA5-12W□□□□-V1 NA5-9W□□□□-V1 NA5-7W□□□□-V1	Number of light and dark pixels: 10 or less. (There must not be 3 consecutive light/dark pixels.)

*2. The backlight can be replaced at an OMRON maintenance base.

*3. This is the estimated time before brightness is reduced by half at room temperature and humidity. The life expectancy is drastically shortened if Programmable Terminal is used at high temperatures.

*4. The brightness of the front panel indicators is also adjustable when you adjust the brightness of the backlight.

Operation

Item	Specification			
	NA5-15W	NA5-12W	NA5-9W	NA5-7W
Touch panel	Method: Analog resistive membrane type			
	Resolution: 16,384 × 16,384			
	Life: 1,000,000 operations			
Function keys *1	3 inputs (capacitance inputs)			

*1. Each function key has blue indicator. The brightness of the function key indicators is also adjustable when you adjust the brightness of the backlight.

Data Capacity

Item	Specification			
	NA5-15W	NA5-12W	NA5-9W	NA5-7W
User data capacity	256 MB			

External Interfaces

Item	Specifications (Same for all models.)	
Ethernet ports	Applications	Port 1: Connecting to anything other than the Sysmac Studio, e.g., device connections and VNC clients Port 2: Connecting to the Sysmac Studio in addition to the applications of port 1.
	Number of ports	2 ports
	Compliant standards	IEEE 802.3i (10BASE-T), IEEE 802.3u (100BASE-TX), and IEEE 802.3ab (1000Base-T)
	Transmission media	Shielded twisted-pair (STP) cable: Category 5, 5e, or higher
	Transmission distance	100 m
USB host ports *1 *2	Connector	RJ-45 8P8C modular connector
	Applications	USB Memory Device, keyboard, or mouse
	Number of ports	2 ports
	Compliant standards	USB 2.0
	Transmission distance	5 m max.
USB slave port *1	Connector	Type-A connector
	Applications	Sysmac Studio connection
	Number of ports	1 port
	Compliant standards	USB 2.0
	Transmission distance	5 m max.
Serial port *3	Connector	Type-B connector
	Applications	Device Connection
	Number of ports	1 port
	Compliant standards	RS-232C
	Transmission distance	15 m max.
SD Memory Card slot	Connector	D-DUB 9-pin female connector
	Applications	To transfer or store the project or to store log data.
	Number of slots	1 slot
	Compliant standards	SD/SDHC

*1. Connection to all USB 2.0-compliant devices is not guaranteed.

*2. Use a USB memory for temporary applications such as transferring data.

*3. The serial port is for future expansion.

Note: 1. For information on the product whose model number does not end with -V1, refer to the Programmable Terminal NA Series Datasheet (Cat. No. V413).

General Specifications

Item	Specification			
	NA5-15W	NA5-12W	NA5-9W	NA5-7W
Rated supply voltage	24 VDC			
Allowable power supply voltage range	19.2 to 28.8 VDC (24 VDC ±20%)			
Allowable momentary power interruption time	Operation for momentary power interruption is not specified.			
Power consumption	29 W max.	25 W max.	23 W max.	19 W max.
Ambient operating temperature	0 to 50°C *1 *2			
Ambient storage temperature	-20 to +60°C *3			
Ambient operating humidity	10 to 90% *2 Must be no condensation.			
Atmosphere	Must be free from corrosive gases.			
Pollution degree	2 or less: Meets IEC 61010-2-201.			
Noise immunity	2 kV on power supply line (Conforms to IEC 61000-4-4.)			
Vibration resistance (during operation)	Conforms to IEC 60068-2-6. 5 to 8.4 Hz with 3.5 mm half amplitude and 8.4 to 150 Hz with 9.8 m/s ² for 100 minutes each in X, Y, and Z directions (Time coefficient of 10 minutes × coefficient factor of 10 = total time of 100 min.)			
Shock resistance (during operation)	Conforms to IEC 60028-2-27. 147 m/s ² 3 times each in X, Y, and Z directions			
Dimensions	420 × 291 × 69 mm (W × H × D)	340 × 244 × 69 mm (W × H × D)	290 × 190 × 69 mm (W × H × D)	236 × 165 × 69 mm (W × H × D)
Panel cutout dimensions	392 ⁺¹ ₀ × 268 ⁺¹ ₀ mm (horizontal × vertical) Panel thickness: 1.6 to 6.0 mm *4	310 ⁺¹ ₀ × 221 ⁺¹ ₀ mm (horizontal × vertical) Panel thickness: 1.6 to 6.0 mm *4	261 ⁺¹ ₀ × 166 ⁺¹ ₀ mm (horizontal × vertical) Panel thickness: 1.6 to 6.0 mm *4	197 ^{+0.5} ₀ × 141 ^{+0.5} ₀ mm (horizontal × vertical) Panel thickness: 1.6 to 6.0 mm *4
Weight	3.2 kg max.	2.4 kg max.	1.8 kg max.	1.4 kg max.
Degree of protection	Front-panel controls: IP65 oil-proof type, UL Type 4X (at initial state) To reinstall the NA Unit in a panel, contact your OMRON representative for replacement of the rubber packing.			
Battery life	Battery life: 5 years at 25°C The RTC will be backed up for 5 days after the battery runs low. The RTC will be backed up by a super capacitor for 5 minutes after removing the old battery. (This assumes that the power is first turned ON for at least 5 minutes and then turned OFF.)			
International standards *5	UL61010-2-201/CSA C22.2 NO.61010-2-201:14 *6 EMC Directive (2004/108/EC) EN 61131-2:2007 Shipbuilding standards LR, DNV, and NK IP65 oil-proof, UL Type 4X *7(front panel only) UL 121201, 9th Edition/CSA C22.2 NO.213-2017 EAC IEC61131-2:2007 KC Standards KN61131-2 2018 RCM EN61000-6-4:2007+A1:2011			

- *1. The ambient operating temperature is subject to the following restrictions, depending on the mounting angle.
- The ambient operating temperature is 0° to 40°C when the mounting angle is 0° or more and less than 45° to the horizontal.
 - The ambient operating temperature is 0° to 50°C when the mounting angle is 45° or more and 90° or less to the horizontal.
 - The ambient operating temperature is 0° to 50°C when the mounting angle is 90° or more and 135° or less to the horizontal.

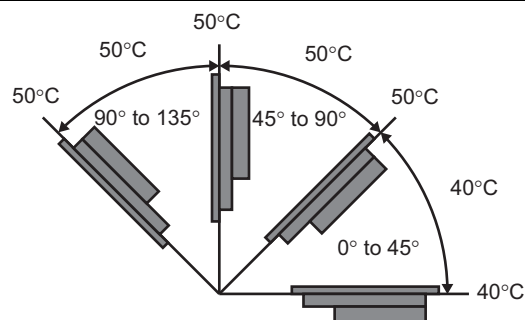

- *2. Use the Programmable Terminal within the following temperature and humidity ranges.

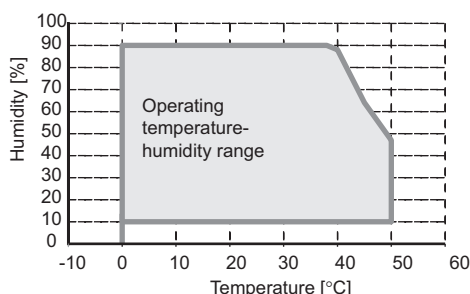

- *3. Store the Programmable Terminal within the following temperature and humidity ranges.

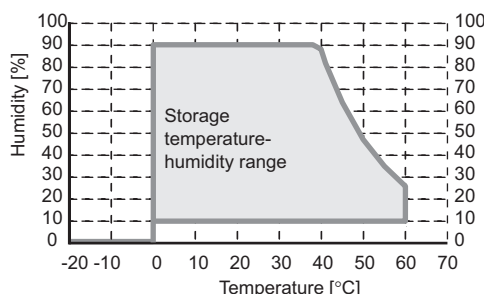

- *4. When the NA-□WATW01 High-pressure Waterproof Attachment is used, the panel thickness is between 1.6 to 4.5 mm.
 *5. Check with your OMRON representative or refer to the following OMRON website for the latest information on the applicable standards for each model: www.ia.omron.com.
 *6. Use power supply Class 2 to conform to UL Standards.
 *7. Use the NA-□WATW01 High-pressure Waterproof Attachment (sold separately) to conform to UL Type 4X.
Note: 1. For information on the product whose model number does not end with -V1, refer to the Programmable Terminal NA Series Datasheet (Cat. No. V413).

NA series

Version Information



NA series and Programming Devices

NA series		Corresponding unit versions/version	
Model	NA system version	NJ/NX/NY-series Controller NX701-□□□□ NY512-□□□□ NX102-□□□□ NY532-□□□□ NX1P2-□□□□ NJ501-□□□□ NX-CSG320 NJ301-□□□□ NJ101-□□□□	Sysmac studio
NA5-□□□□□□-V1	1.10 or later	NX-CSG320: 1.00 or later	1.24 or higher
	1.09 or later	NX102: 1.30 or later	1.23 or higher
	1.08 or later	NX1P2: 1.13 or later NY512: 1.12 or later NY532: 1.12 or later NX701: 1.10 or later NJ101: 1.10 or later NJ501: 1.01 or later NJ501 Database Connection: 1.05 or later NJ301: 1.01 or later	1.40 or higher

Components and Functions

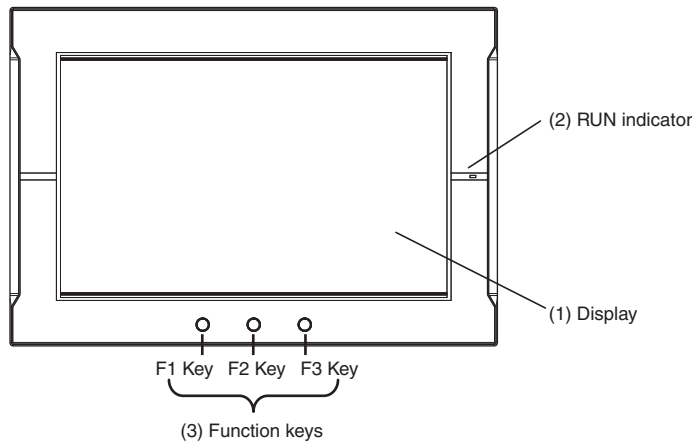
Front Panel



No.	Name	Description
(1)	Display	The entire display is a touch panel that also functions as an input device.
(2)	RUN indicator	The status of the indicator changes according to the status of the NA.
(3)	Function keys	<p>There are three function keys: F1, F2, and F3.</p> <p>  : F1 Key,  : F2 Key,  : F3 Key </p> <p>You can use the function keys as execution conditions for the actions for global or page events. You can also use the function keys for interlocks.</p>

Back Panel

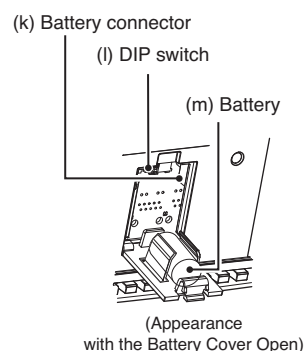
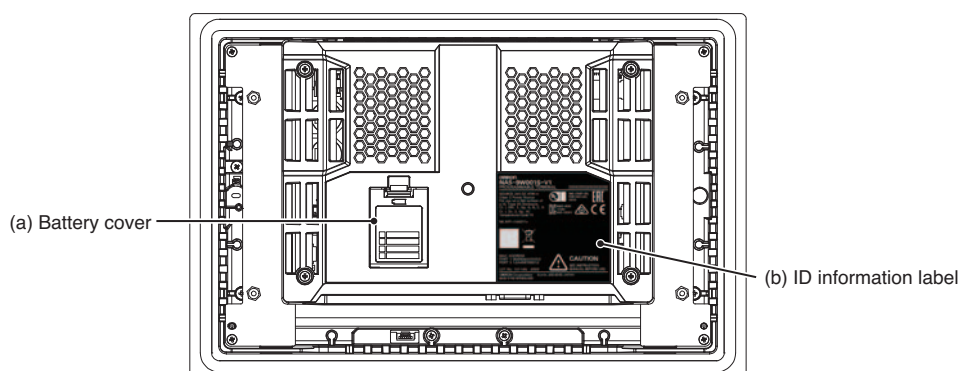

Bottom Panel

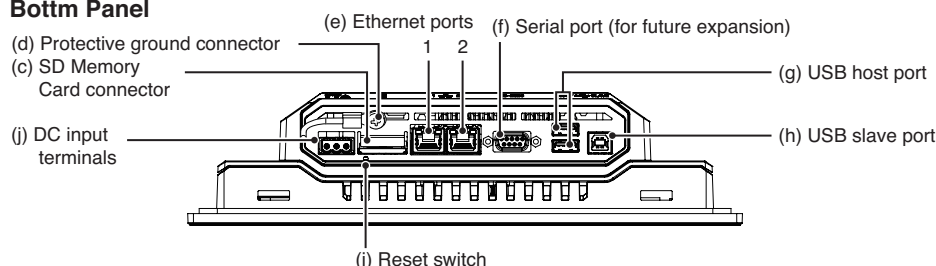

No.	Name	Description
(a)	Battery cover	Open this cover to replace the Battery.
(b)	ID information label	You can check the ID information of the NA Unit.
(c)	SD Memory Card connector	Insert an SD Memory Card here.
(d)	Protective ground terminal	Use for protective grounding.
(e)	Ethernet port 1	Connect a device other than the Sysmac Studio.
	Ethernet port 2	Connect mainly the Sysmac Studio.
(f)	Serial port *1	For future expansion.
(g)	USB host port	Connect this port to a USB Memory Device, keyboard, mouse, etc.
(h)	USB slave port	Connect the Sysmac Studio or other devices.
(i)	Reset switch	Use this switch to reset the NA Unit.
(j)	DC input terminals	These are the power supply terminals. Connect the accessory power supply connector and supply power.
(k)	Battery connector	Connect the connector on the backup Battery here.
(l)	DIP switch	Used for system recovery. (The DIP switch is on a PCB that is accessed by opening the Battery cover.) In other cases, do not change any of the factory settings of the pins on the DIP switch.
(m)	Battery	This is the battery to backup the clock information in the NA Unit.

*1. The serial port is for future expansion.

Note: 1. For information on the product whose model number does not end with -V1, refer to the Programmable Terminal NA Series Datasheet (Cat. No. V413).

Supported Devices

Manufacturer	Models	Connection method	Communications driver
OMRON	CK3E-1□10 CK3M-CPU1□1	Built-in Ethernet port	Modbus/TCP
	NX701-□□□□ NY512-□□□□ NX102-□□□□ NY532-□□□□ NX1P2-□□□□ NJ501-□□□□ NX-CSG320 NJ301-□□□□ NJ101-□□□□	Built-in EtherNet/IP port	Ethernet
	CJ2H-CPU64/65/66/67/68-EIP CJ2M-CPU31/32/33/34/35	Built-in EtherNet/IP port	CIP Ethernet
	CJ2H-CPU64/65/66/67/68-EIP CJ2M-CPU31/32/33/34/35	CJ1W-EIP21	
	CJ2H-CPU64/65/66/67/68-EIP CJ2M-CPU31/32/33/34/35	Built-in EtherNet/IP port	FINS Ethernet
	CJ1H-CPU65H/66H/67H CJ1H-CPU65H/66H/67H-R CJ1G-CPU42H/43H/44H/45H CJ1M-CPU11/12/13/21/22/23 CJ2H-CPU64/65/66/67/68(-EIP) CJ2M-CPU11/12/13/14/15 CJ2M-CPU31/32/33/34/35	CJ1W-ETN21 CJ1W-EIP21	

NA series

Dimensions

(Unit: mm)

NA5-15W101S-V1/-15W101B-V1

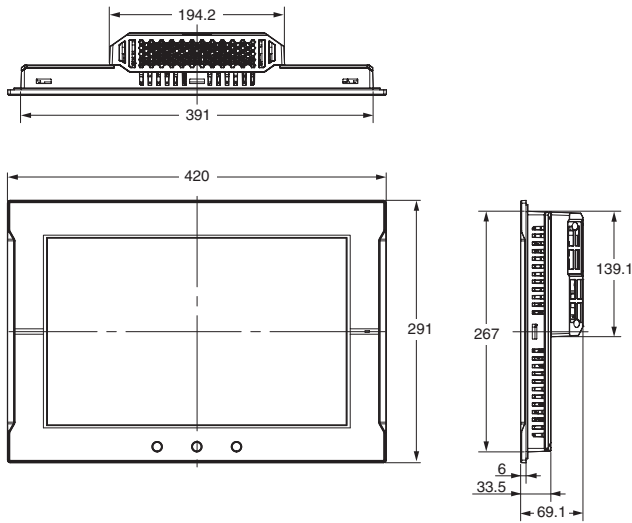

Cable Connection Dimensions

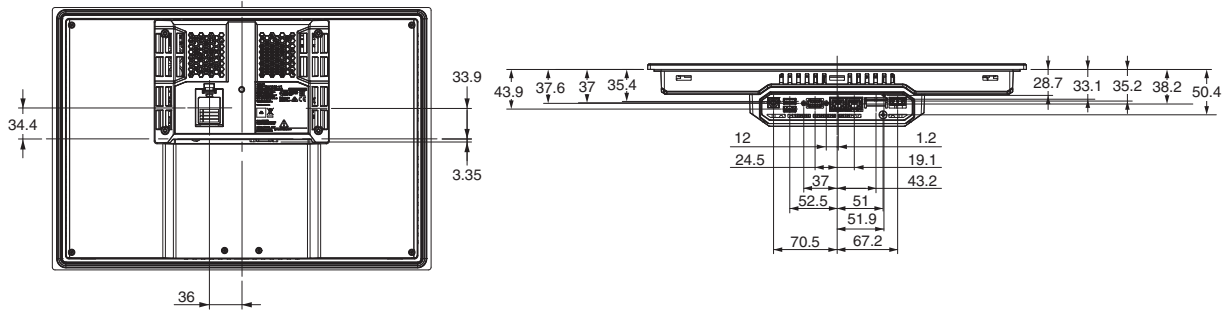

NA5-12W101S-V1/-12W101B-V1

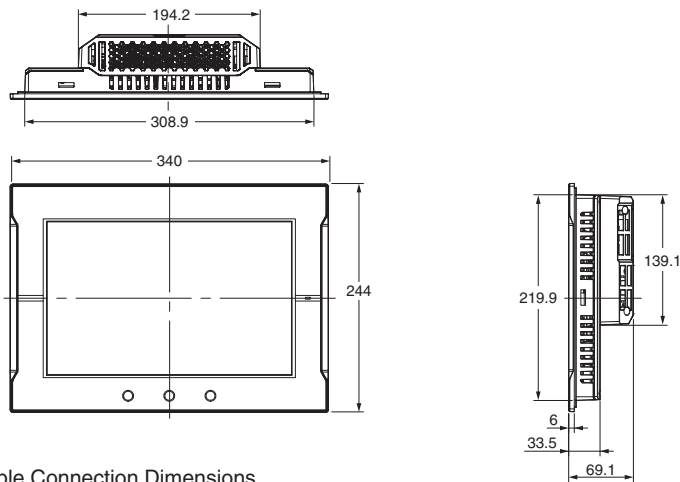

Cable Connection Dimensions

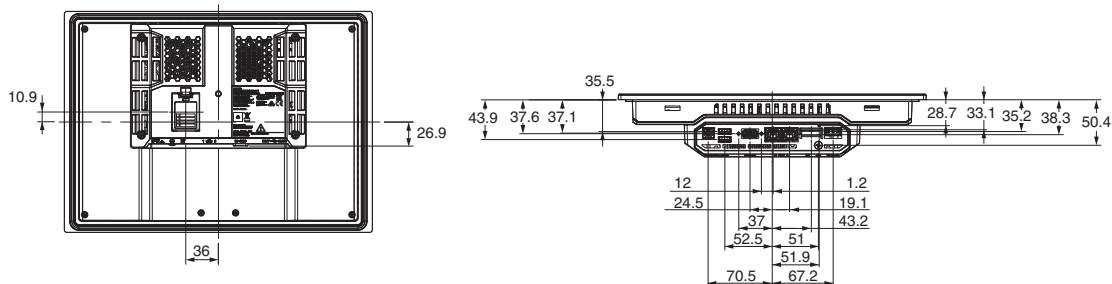

NA5-9W001S-V1/-9W001B-V1

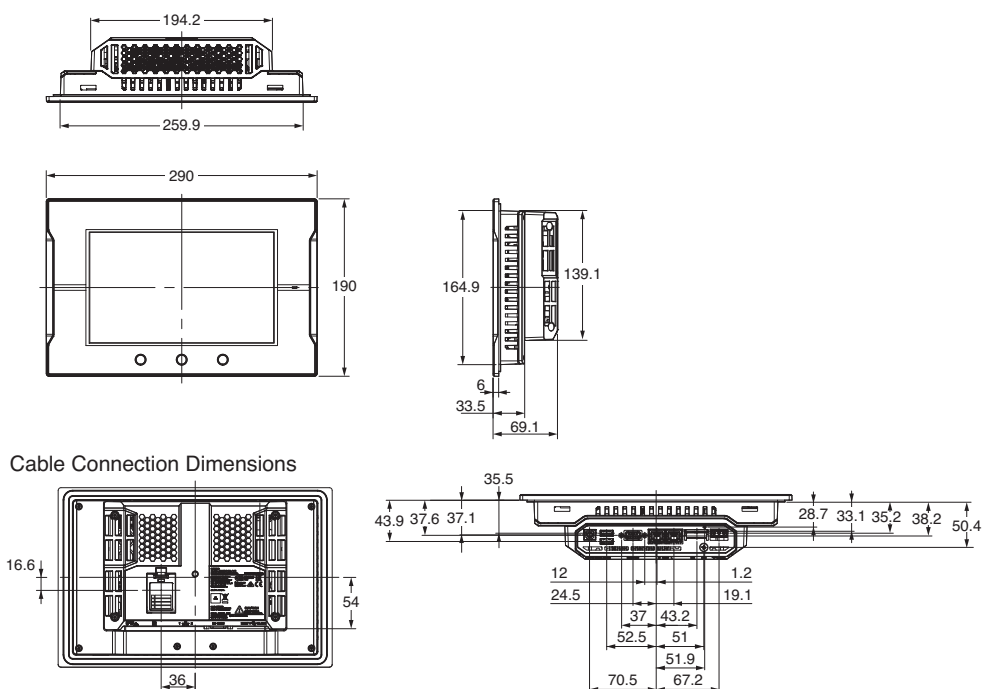

NA5-7W001S-V1/-7W001B-V1

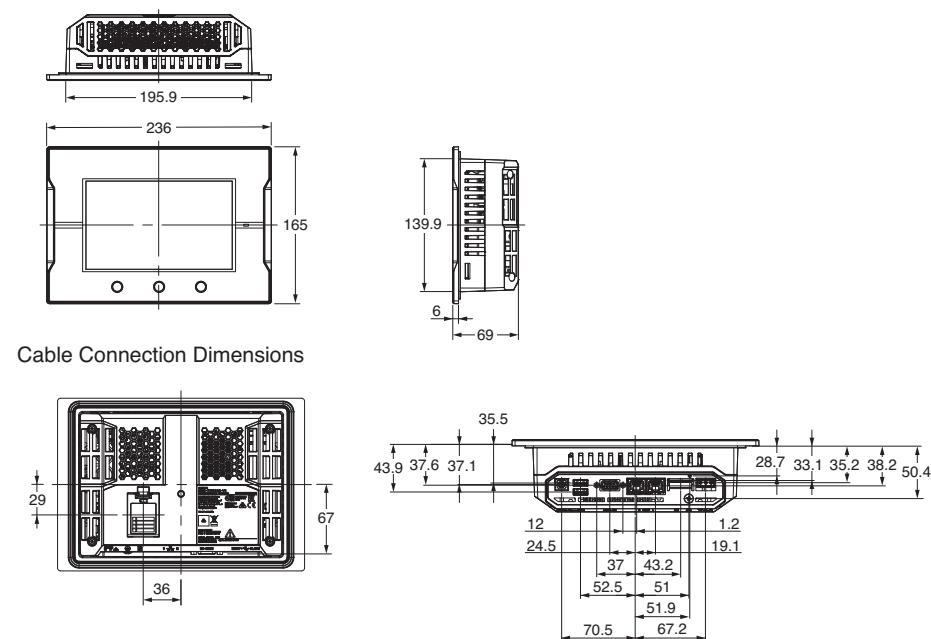

Note: 1. For information on the product whose model number does not end with -V1, refer to the Programmable Terminal NA Series Datasheet (Cat. No. V413).

NA series

Related Manuals

Cat. No.	Model number	Manual
V125	NA5-15□101□-V1 NA5-12□101□-V1 NA5-9□001□-V1 NA5-7□001□-V1	NA-series Programmable Terminal Hardware (-V1) User's Manual
V118	NA5-15□101□ (-V1) NA5-12□101□ (-V1) NA5-9□001□ (-V1) NA5-7□001□ (-V1) NA-RTL□□	NA-series Programmable Terminal Software User's Manual
V119	NA5-15□101□ (-V1) NA5-12□101□ (-V1) NA5-9□001□ (-V1) NA5-7□001□ (-V1) NA-RTL□□	NA-series Programmable Terminal Device Connection User's Manual
V120	NA5-15W□□□□ NA5-12W□□□□ NA5-9W□□□□ NA5-7W□□□□	NA-series Programmable Terminal Startup Guide
V126	NA-RTL□□□	NA-series Programmable Terminal Soft-NA User's Manual

Sysmac is a trademark or registered trademark of OMRON Corporation in Japan and other countries for OMRON factory automation products.
Windows, Visual Basic, Word, Excel are either registered trademarks or trademarks of Microsoft Corporation in the United States and/or other countries.
EtherCAT® is registered trademark and patented technology, licensed by Beckhoff Automation GmbH, Germany.
EtherNet/IP™ is the trademarks of ODVA.

Intel, Atom are trademarks or registered trademarks of Intel Corporation or its subsidiaries in the United States and other countries.

The SD logo is a trademark of SD-3C, LLC. 

Some images are used under license from Shutterstock.com.

Other company names and product names in this document are the trademarks or registered trademarks of their respective companies.

The product photographs and figures that are used in this catalog may vary somewhat from the actual products.

Microsoft product screen shot(s) reprinted with permission from Microsoft Corporation.

Terms and Conditions Agreement

Read and understand this catalog.

Please read and understand this catalog before purchasing the products. Please consult your OMRON representative if you have any questions or comments.

Warranties.

- (a) Exclusive Warranty. Omron's exclusive warranty is that the Products will be free from defects in materials and workmanship for a period of twelve months from the date of sale by Omron (or such other period expressed in writing by Omron). Omron disclaims all other warranties, express or implied.
- (b) Limitations. OMRON MAKES NO WARRANTY OR REPRESENTATION, EXPRESS OR IMPLIED, ABOUT NON-INFRINGEMENT, MERCHANTABILITY OR FITNESS FOR A PARTICULAR PURPOSE OF THE PRODUCTS. BUYER ACKNOWLEDGES THAT IT ALONE HAS DETERMINED THAT THE PRODUCTS WILL SUITABLY MEET THE REQUIREMENTS OF THEIR INTENDED USE.

Omron further disclaims all warranties and responsibility of any type for claims or expenses based on infringement by the Products or otherwise of any intellectual property right. (c) Buyer Remedy. Omron's sole obligation hereunder shall be, at Omron's election, to (i) replace (in the form originally shipped with Buyer responsible for labor charges for removal or replacement thereof) the non-complying Product, (ii) repair the non-complying Product, or (iii) repay or credit Buyer an amount equal to the purchase price of the non-complying Product; provided that in no event shall Omron be responsible for warranty, repair, indemnity or any other claims or expenses regarding the Products unless Omron's analysis confirms that the Products were properly handled, stored, installed and maintained and not subject to contamination, abuse, misuse or inappropriate modification. Return of any Products by Buyer must be approved in writing by Omron before shipment. Omron Companies shall not be liable for the suitability or unsuitability or the results from the use of Products in combination with any electrical or electronic components, circuits, system assemblies or any other materials or substances or environments. Any advice, recommendations or information given orally or in writing, are not to be construed as an amendment or addition to the above warranty.

See <http://www.omron.com/global/> or contact your Omron representative for published information.

Limitation on Liability; Etc.

OMRON COMPANIES SHALL NOT BE LIABLE FOR SPECIAL, INDIRECT, INCIDENTAL, OR CONSEQUENTIAL DAMAGES, LOSS OF PROFITS OR PRODUCTION OR COMMERCIAL LOSS IN ANY WAY CONNECTED WITH THE PRODUCTS, WHETHER SUCH CLAIM IS BASED IN CONTRACT, WARRANTY, NEGLIGENCE OR STRICT LIABILITY.

Further, in no event shall liability of Omron Companies exceed the individual price of the Product on which liability is asserted.

Suitability of Use.

Omron Companies shall not be responsible for conformity with any standards, codes or regulations which apply to the combination of the Product in the Buyer's application or use of the Product. At Buyer's request, Omron will provide applicable third party certification documents identifying ratings and limitations of use which apply to the Product. This information by itself is not sufficient for a complete determination of the suitability of the Product in combination with the end product, machine, system, or other application or use. Buyer shall be solely responsible for determining appropriateness of the particular Product with respect to Buyer's application, product or system. Buyer shall take application responsibility in all cases.

NEVER USE THE PRODUCT FOR AN APPLICATION INVOLVING SERIOUS RISK TO LIFE OR PROPERTY OR IN LARGE QUANTITIES WITHOUT ENSURING THAT THE SYSTEM AS A WHOLE HAS BEEN DESIGNED TO ADDRESS THE RISKS, AND THAT THE OMRON PRODUCT(S) IS PROPERLY RATED AND INSTALLED FOR THE INTENDED USE WITHIN THE OVERALL EQUIPMENT OR SYSTEM.

Programmable Products.

Omron Companies shall not be responsible for the user's programming of a programmable Product, or any consequence thereof.

Performance Data.

Data presented in Omron Company websites, catalogs and other materials is provided as a guide for the user in determining suitability and does not constitute a warranty. It may represent the result of Omron's test conditions, and the user must correlate it to actual application requirements. Actual performance is subject to the Omron's Warranty and Limitations of Liability.

Change in Specifications.

Product specifications and accessories may be changed at any time based on improvements and other reasons. It is our practice to change part numbers when published ratings or features are changed, or when significant construction changes are made. However, some specifications of the Product may be changed without any notice. When in doubt, special part numbers may be assigned to fix or establish key specifications for your application. Please consult with your Omron's representative at any time to confirm actual specifications of purchased Product.

Errors and Omissions.

Information presented by Omron Companies has been checked and is believed to be accurate; however, no responsibility is assumed for clerical, typographical or proofreading errors or omissions.

Note: Do not use this document to operate the Unit.

OMRON Corporation Industrial Automation Company

Kyoto, JAPAN

Contact: www.ia.omron.com

Regional Headquarters

OMRON EUROPE B.V.

Wegalaan 67-69, 2132 JD Hoofddorp
The Netherlands
Tel: (31)2356-81-300/Fax: (31)2356-81-388

OMRON ELECTRONICS LLC

2895 Greenspoint Parkway, Suite 200
Hoffman Estates, IL 60169 U.S.A.
Tel: (1) 847-843-7900/Fax: (1) 847-843-7787

OMRON ASIA PACIFIC PTE. LTD.

438B Alexandra Road, #08-01/02 Alexandra
Technopark, Singapore 119968
Tel: (65) 6835-3011/Fax: (65) 6835-2711

OMRON (CHINA) CO., LTD.

Room 2211, Bank of China Tower,
200 Yin Cheng Zhong Road,
PuDong New Area, Shanghai, 200120, China
Tel: (86) 21-5037-2222/Fax: (86) 21-5037-2200

Authorized Distributor:

© OMRON Corporation 2020-2022 All Rights Reserved.
In the interest of product improvement,
specifications are subject to change without notice.

CSM_2_5

Cat. No. V457-E1-06

0322 (0320)