



**EN** Operating instructions. . . . .pages 1 to 4  
Translation of the original operating instructions

**Content**

**1 About this document**

1.1 Function . . . . . 1

1.2 Target group: authorised qualified personnel. . . . . 1

1.3 Explanation of the symbols used . . . . . 1

1.4 General safety instructions . . . . . 1

1.5 Warning about misuse . . . . . 1

1.6 Exclusion of liability . . . . . 1

**2 Product description**

2.1 Ordering code . . . . . 2

2.2 Special versions. . . . . 2

2.3 Destination and use . . . . . 2

**3 Mounting**

3.1 General mounting instructions . . . . . 2

3.2 Dimensions . . . . . 2

3.3 Sequence of the steps . . . . . 3

**4 Appendix**

4.1 Set-up checklist . . . . . 4

**1. About this document**

**1.1 Function**  
This operating instructions manual provides all the information you need for the mounting, set-up and commissioning to ensure the safe operation and disassembly of the the product. The operating instructions must be available in a legible condition and a complete version in the vicinity of the device.

**1.2 Target group: authorised qualified personnel**  
All operations described in this operating instructions manual must be carried out by trained specialist personnel, authorised by the plant operator only.

Please make sure that you have read and understood these operating instructions and that you know all applicable legislations regarding occupational safety and accident prevention prior to installation and putting the component into operation.

The machine builder must carefully select the harmonised standards to be complied with as well as other technical specifications for the selection, mounting and integration of the components.

**1.3 Explanation of the symbols used**

 **Information, hint, note:**  
This symbol is used for identifying useful additional information.

 **Caution:** Failure to comply with this warning notice could lead to failures or malfunctions.  
**Warning:** Failure to comply with this warning notice could lead to physical injury and/or damage to the machine.

**1.4 General safety instructions**  
The user must observe the safety instructions in this operating instructions manual, the country-specific installation standards as well as all prevailing safety regulations and accident prevention rules.

 Further technical information can be found in the Schmersal catalogues or in the online catalogue on the Internet: [www.schmersal.net](http://www.schmersal.net).

The information contained in this operating instructions manual is provided without liability and is subject to technical modifications.

There are no residual risks, provided that the safety instructions as well as the instructions regarding mounting, commissioning, operation and maintenance are observed.

**1.5 Warning about misuse**

 In case of inadequate or improper use or manipulations of the component, personal hazards or damage to machinery or plant components cannot be excluded. The relevant requirements of the standard EN ISO 14119 must be observed.

**1.6 Exclusion of liability**  
We shall accept no liability for damages and malfunctions resulting from defective mounting or failure to comply with this operating instructions manual. The manufacturer shall accept no liability for damages resulting from the use of unauthorised spare parts or accessories.

For safety reasons, invasive work on the device as well as arbitrary repairs, conversions and modifications to the device are strictly forbidden; the manufacturer shall accept no liability for damages resulting from such invasive work, arbitrary repairs, conversions and/or modifications to the device.

## 2. Product description

### 2.1 Ordering code

This operating instructions manual applies to the following types:

**AZ/AZM 200-B1-①T②**

No.	Option	Description
①	L	Left-hand side actuating direction
	R	Right-hand side actuating direction
②	P0	without Emergency exit with emergency exit



Only if the information described in this operating instructions manual are realised correctly, the safety function and therefore the compliance of the entire system with the Machinery Directive is maintained.

### 2.2 Special versions

For special versions, which are not listed in the order code below 2.1, these specifications apply accordingly, provided that they correspond to the standard version.

### 2.3 Destination and use

The AZ/AZM 200-B1 actuator is preferably used on sliding safety guards in conjunction with the AZ 200 safety switch or the AZM 200 solenoid interlock.

The AZ/AZM 200-B1-...P0 actuator with emergency exit is only suitable for the AZM 200 solenoid interlock in concealed mounting.

### Emergency exit P0

When the emergency exit collar of the AZ/AZM 200-B1-...P0 actuator with emergency exit is pulled in the direction of the arrow (see image), the AZM 200 is unlocked and the safety guard can be opened. When the safety guard is closed, it is immediately re-locked. The autonomous, spring-loaded return of the unlocking mechanism, which is installed by the builder, must be guaranteed.

### Actuator unit play

X = ± 1.5 mm

Y = ± 5.0 mm

Z = ± 1.0 mm

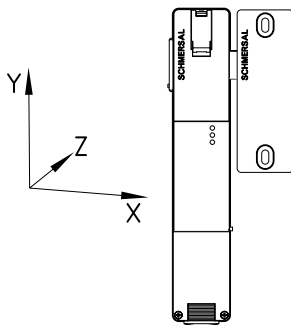

## 3. Mounting

### 3.1 General mounting instructions



The installation may only be carried out by authorised personnel.

The AZ/AZM 200-B1 has an elastic bearing. The overtravel amounts to max. 5 mm. The distance between the actuator flange and the switch enclosure must be  $5 \pm 1.5$  mm when the actuator is inserted.

### 3.2 Dimensions

All measurements in mm.

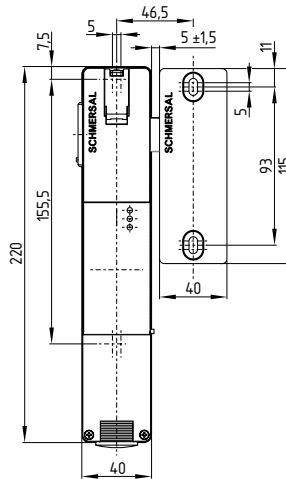

### AZ/AZM 200-B1 actuator

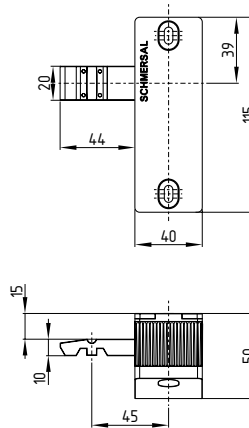

### AZ/AZM 200-B1-...P0 actuator with emergency exit

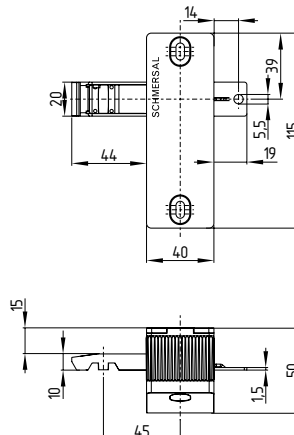

### 3.3 Sequence of the steps

#### Step 1

- Unscrew cover **B** for the wiring compartment and open flap **A** manual release

#### To be observed

- Actuation of the manual release by triangular key (included in delivery AZ/AZM)

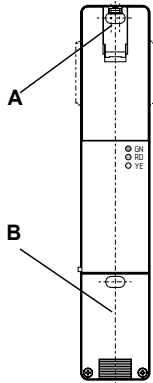

#### Step 2

- The AZ/AZM enclosure must be flush-mounted with the doorpost

#### To be observed

- Screws DIN 912-M6
- Max. torque for solenoid interlock = 8 Nm, cover screw = 0.7...1 Nm (Torx T10)
- Wall thickness of the device 19 mm
- Washers DIN 125-6.4 (included in delivery AZ/AZM)
- For applications with strong vibrations, please observe a proper securing of the screws

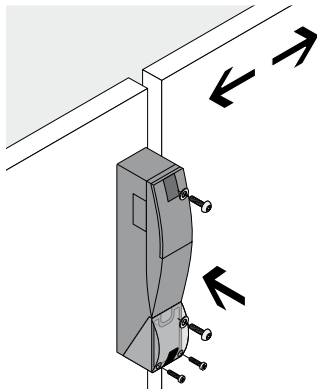

#### Step 3

- Fit the actuator to the doorpost

#### To be observed

- **AZ/AZM 200-B1-...P0 actuator with emergency exit is only suitable for concealed mounting!**
- Top side of the safety switch or solenoid interlock flush with actuator top side
- Distance between safety switch or solenoid interlock and actuator:  $5 \pm 1.5$  mm
- Screws DIN 912-M6
- Wall thickness of the device 8 mm
- Max. tightening torque 8 Nm
- For applications with strong vibrations, please observe a proper securing of the screws

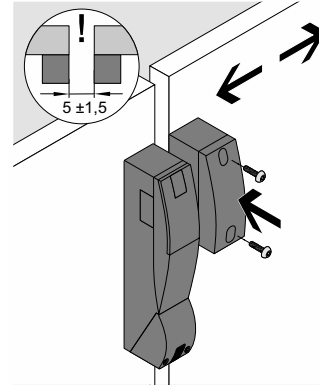

#### Step 4

- Clip the dust-proof flap in the unused side

#### To be observed

- R = right-hand side actuating direction
- L = Left-hand side actuating direction

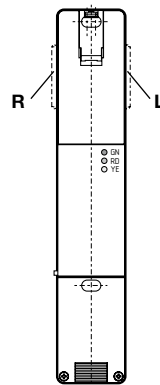

#### Step 5

- Seal the cover

#### To be observed:

- After being put into operation, the manual release must be secured by installing the seal, which is included in delivery.

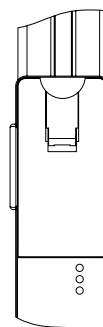

4.1 Set-up checklist



## Checklist

### Set-up and maintenance

---

**Checking of the AZ/AZM 200 safety door-handle system**  
During the set-up and the regular maintenance of the machine, the following items of the safety door-handle system, consisting of the AZ or AZM 200, the corresponding actuator unit and the emergency exit, must be checked and inspected by a professional:

**1. Fixation:**

All fixing screws installed and tightened with the specified torque

**2. Distance:**

Distance  $5 \pm 1.5$  mm between AZ/AZM 200 and actuator unit observed.

**3. Dust shield cap:**

Check tight fitting of the dust-proof flap

**4. Functional testing:**

The enabling signal is only transmitted to the safety circuit, if the actuator unit is within range of the solenoid interlock and locked.

LED	Status
green	Operating voltage
yellow	Actuator inserted (and locked for AZM 200)
flashes yellow	Actuator inserted and not locked (only for AZM 200)
red	Error

**5. Cover for manual release:**

Cover is sealed. (only for AZM 200)

---

Date / Signature: \_\_\_\_\_

**K. A. Schmersal GmbH & Co. KG**  
Möddinghofe 30, D - 42279 Wuppertal  
Postfach 24 02 63, D - 42232 Wuppertal

Phone: +49 - (0)2 02 - 64 74 - 0  
Telefax: +49 - (0)2 02 - 64 74 - 1 00  
E-Mail: [info@schmersal.com](mailto:info@schmersal.com)  
Internet: <http://www.schmersal.com>