

Product Description

- ◆ Transistor or MOSFET Output
- ◆ Optical Isolation
- ◆ Load Current : 0.1A, 2A, 3A, or 4A
- ◆ Load Voltage: 24VDC or 48VDC
- ◆ PCB or Socket Mounted
- ◆ Dielectric Strength: 2500Vrms
- ◆ RoHS Compliant

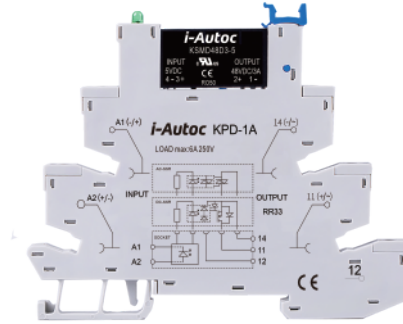

Ordering Information

KSM	D	48	D	3	-5	D
KSM Series	Load Type D: DC Load	Load Voltage 24: 24VDC 48: 48VDC	DC Control	Load Current 0.1: 0.1Amp 2: 2Amp 3: 3Amp 4: 4Amp	Control Voltage 5: 5VDC 12: 12VDC 24: 24VDC 48: 48VDC 60: 60VDC	Blank: without Socket D: with Socket

Note: (1)For KSMD with control voltage at 12V, 24V, 48V, 60V equipped with a socket, the control voltage limit should be increased by 1.4V, for example, for KSMD24D2-12D, please ensure that the control voltage is 9.6V+1.4V=11V Min

	0.1A	2A	3A	4A
5:4-6VDC	KSMD24D0.1-5	KSMD24D2-5	KSMD24D3-5	KSMD24D4-5
	KSMD24D0.1-5D	KSMD24D2-5D	KSMD24D3-5D	KSMD24D4-5D
	KSMD48D0.1-5	KSMD48D2-5	KSMD48D3-5	KSMD48D4-5
	KSMD48D0.1-5D	KSMD48D2-5D	KSMD48D3-5D	KSMD48D4-5D
12:9.6-14.4VDC	KSMD24D0.1-12	KSMD24D2-12	KSMD24D3-12	KSMD24D4-12
	KSMD24D0.1-12D	KSMD24D2-12D	KSMD24D3-12D	KSMD24D4-12D
	KSMD48D0.1-12	KSMD48D2-12	KSMD48D3-12	KSMD48D4-12
	KSMD48D0.1-12D	KSMD48D2-12D	KSMD48D3-12D	KSMD48D4-12D
24:19.2-28.8VDC	KSMD24D0.1-24	KSMD24D2-24	KSMD24D3-24	KSMD24D4-24
	KSMD24D0.1-24D	KSMD24D2-24D	KSMD24D3-24D	KSMD24D4-24D
	KSMD48D0.1-24	KSMD48D2-24	KSMD48D3-24	KSMD48D4-24
	KSMD48D0.1-24D	KSMD48D2-24D	KSMD48D3-24D	KSMD48D4-24D
48:38.4-57.6VDC	KSMD24D0.1-48	KSMD24D2-48	KSMD24D3-48	KSMD24D4-48
	KSMD24D0.1-48D	KSMD24D2-48D	KSMD24D3-48D	KSMD24D4-48D
	KSMD48D0.1-48	KSMD48D2-48	KSMD48D3-48	KSMD48D4-48
	KSMD48D0.1-48D	KSMD48D2-48D	KSMD48D3-48D	KSMD48D4-48D
60:48-72VDC	KSMD24D0.1-60	KSMD24D2-60	KSMD24D3-60	KSMD24D4-60
	KSMD24D0.1-60D	KSMD24D2-60D	KSMD24D3-60D	KSMD24D4-60D
	KSMD48D0.1-60	KSMD48D2-60	KSMD48D3-60	KSMD48D4-60
	KSMD48D0.1-60D	KSMD48D2-60D	KSMD48D3-60D	KSMD48D4-60D

General Specifications

Input Specifications (Ta=25°C)		
Control Voltage Range	5	4-6VDC
	12	9.6-14.4VDC
	24	19.2-28.8VDC
	48	38.4-57.6VDC
	60	48-72VDC
Must Turn-on Voltage	5	4VDC
	12	9.6VDC
	24	19.2VDC
	48	38.4VDC
	60	48VDC
Must Turn-off Voltage	5	1VDC
	12	2.4VDC
	24	2.4VDC
	48	4.8VDC
	60	4.8VDC
Maximum Input Current ⁽¹⁾	5	25mA (@6VDC)
	12	25mA (@14.4VDC)
	24	25mA (@28.8VDC)
	48	20mA (@57.6VDC)
	60	15mA (@72VDC)

Output Specifications (Ta=25°C)		
Load Voltage Range	24V	3-28VDC
	48V	3-58VDC
Maximum Transient Overvoltage	24V	33VDC
	48V	58VDC
Load Current Range	0.1A	0.001 - 0.1A
	2A	0.002 - 2A
	3A	0.002 - 3A
	4A	0.002 - 4A
Maximum Turn-on Time	300µs	
Maximum Turn-off Time	300µs	
Maximum Surge Current (@10 ms)	0.1A	1A
	2A	20A
	3A	30A
	4A	48A
Maximum Off-State Leakage Current@Rated Load Voltage	0.1mA	
Maximum On-State Voltage Drop@Rated Current	0.1A	1.5VDC
Maximum On-State Resistance	2A/3A/4A	37MΩ

General Specifications (Ta=25°C)		
Dielectric Strength (50/60Hz)	2500Vrms	
Minimum Insulation Resistance (@500VDC)	1000MΩ	
Ambient Temperature Range	-30°C ~ +80°C	
Storage Temperature Range	-30°C ~ +100°C	
Weight (Typical)	without Socket	4g
	D: with Socket	30g

Outline Dimensions

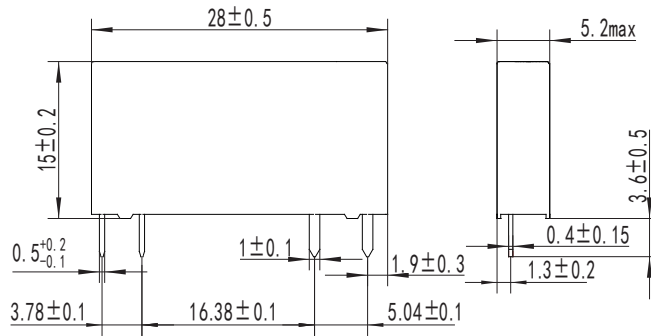

SSR

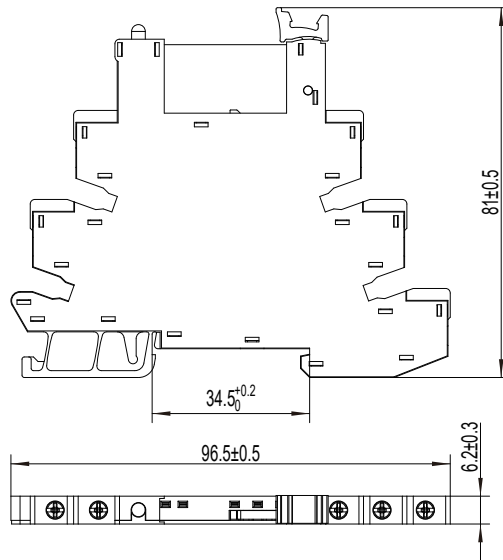

with Socket

Wiring Diagram

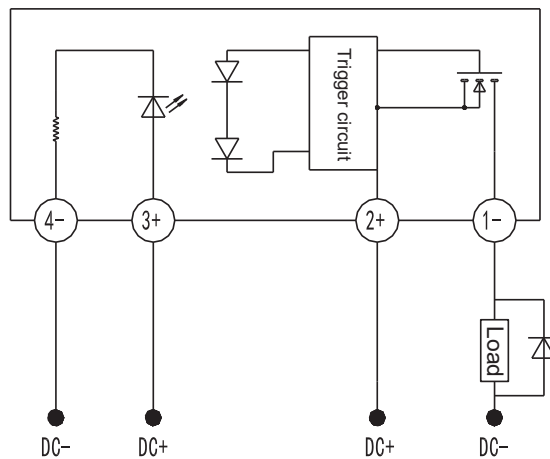

SSR

Wiring Diagram

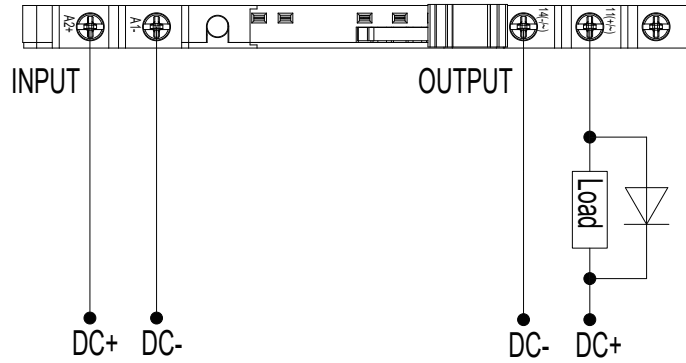

KSMDXXX-5D

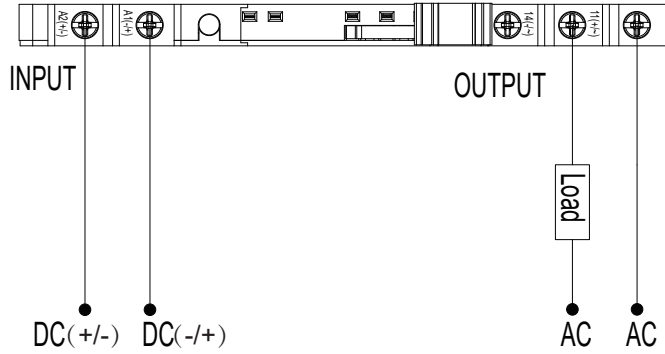

KSMDXXX-(12, 24, 48, 60)D

Applications

Suitable for high density PCB mounted, PLC control applications, and etc.

Thermal Derating Curve

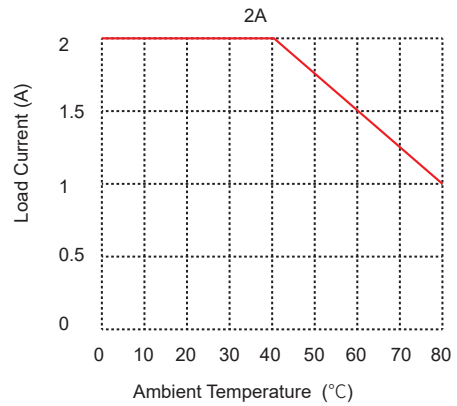
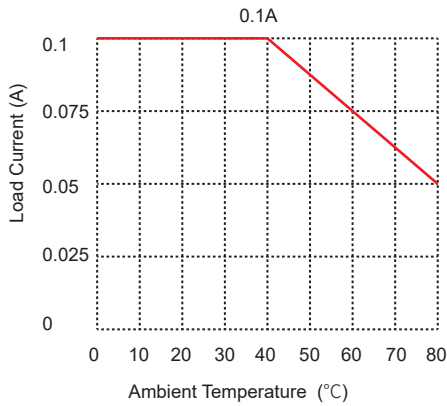

Thermal Derating Curve

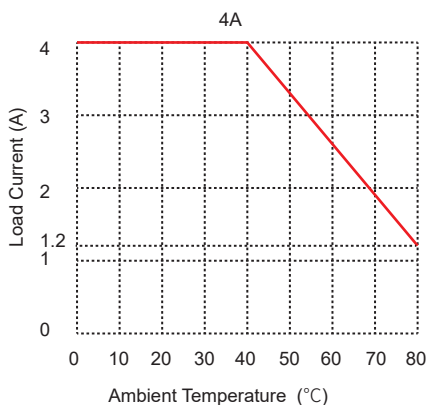
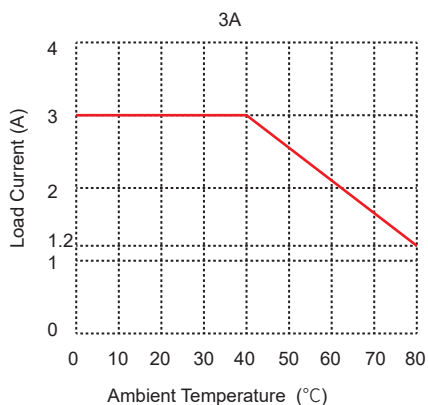

General Notes

1. 260 °C welding temperature, the whole process should not exceed 10 seconds, 350 °C, the welding process should not exceed 5 seconds, otherwise it may cause damage to the product.
2. Make sure the wiring is correct, otherwise the product will be damaged.
3. The recommended mounting torque for base connection is 0.5N ·m.
4. When the ambient temperature of the product is high, please refer to the temperature curve for derating.
5. The capacitive load will generate extremely high inrush current at the moment of re-conduction, which may lead to the damage of solid relay due to excessive inrush current. Therefore, if the load time capacity load or the load has parallel capacitor, it is strongly recommended to series NTC in the load loop to suppress the inrush current so as not to damage the product.