

Miniature Push-Pull Circular Connectors

HR25A Series

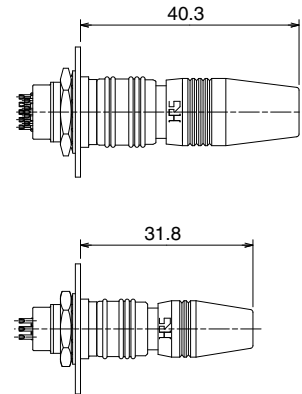

Mated dimensions



■ Features

1. Small size – high density

Outer diameters - plugs (max): 11 mm : 4, 6 and 8 positions
13 mm : 12, 16 and 20 positions

2. Simple push-in/ pull-out mating / un-mating

Polarized for correct insertion by a straight push-in movement.
Built-in lock release mechanism securely locks mated connectors while allowing quick disconnection by simply pulling on the plug release collar.

3. Several mounting number of positions, styles and terminations

Number of positions : 4, 6, 8, 12, 16 and 20
Connector : Plug, jack, receptacle
Termination : Solder, crimp or PCB mounting type only for receptacle
Choice of socket or pin contacts for plugs and receptacles.

4. Metal shells

Secure lock between the metal shells provides excellent ground connection for the applications requiring EMI protection.

5. RoHS compliant

All materials used in are compliant with RoHS regulations.

■ Diagrams of Connectors in Combination

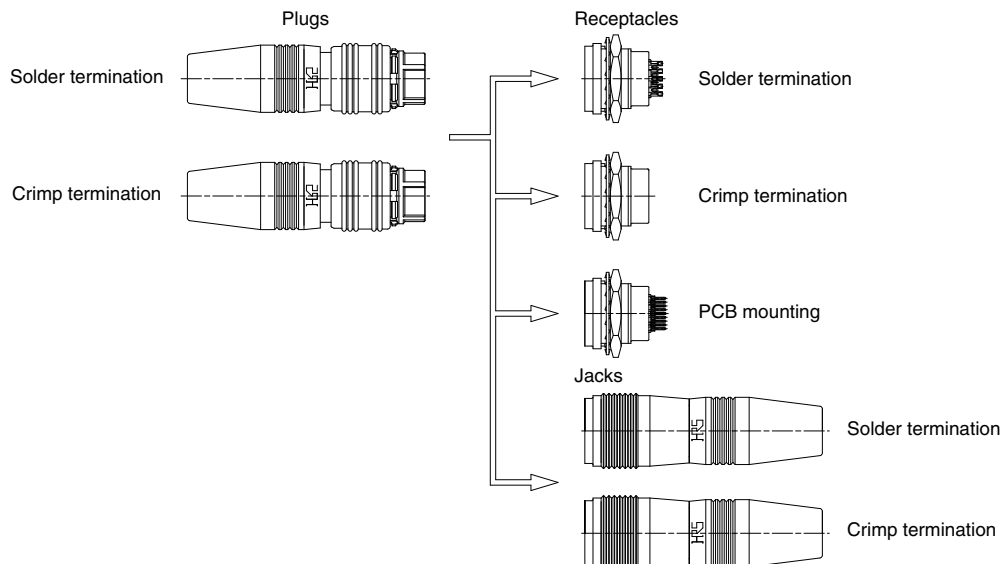

■ Specifications

Ratings	Current rating	1 A	Operating temperature range	-25°C to +85°C
	Voltage rating	30 V AC, 42 V DC	Storage temperature range	-10°C to +60°C
Item	Specification		Conditions	
1. Insulation resistance	1,000 MΩ min.		100 V DC	
2. Withstanding voltage	No flashover or insulation breakdown		100 V AC / one minute (test voltage)	
3. Contact resistance	30 mΩ max.		1 A DC	
4. Durability	Contact resistance: 50 mΩ max.		No damage, cracks or parts dislocation 1,000 cycles	
5. Vibration	No electrical discontinuity of 10 μs or longer No damage, cracks or parts dislocation.		Frequency: 10 to 55 Hz, single amplitude of 0.75 mm 5 minute cycle, 10 cycles in each of the 3 axis	
6. Humidity	Insulation resistance: 5 MΩ min. (at high humidity) Insulation resistance: 50 MΩ min. (when dry) No damage, cracks or parts dislocation.		96 hours at 40°C, and humidity of 90 to 95%	
7. Temperature cycle	Insulation resistance: 1,000 MΩ min.		Temperature: -55°C → room temp. → +85°C → room temp. Time : 30min. → 2to 3 min. → 30min. → 2to 3 min. 5 cycles	

■ Material

Item	Material	Finish	Remarks
Plug Jack	Outer shell	Zinc alloy	Nickel plated
	Insulator	PPS	UL94V-0
	Gasket, boots	Ethylene propylene rubber, Chloroprene rubber	
	Contacts	Phosphor bronze	Gold plated
Receptacle	Outer shell	Zinc alloy	Nickel plated
	Insulator	PPS	UL94V-0
	Contacts	Phosphor bronze	Gold plated

■ Ordering information

HR25A - 7 P - 6 S C ()**

① ② ③ ④ ⑤ ⑥ ⑦

① Model name : HR25A Series	⑤ Contact type: S: Female contacts P: Male contacts
② Shell size : The shell size is the outer diameter of the mating end of the plug.	⑥ Termination type: Blank: Solder C: Crimp A: DIP
③ Connector type: P: Plug R: Receptacle J: Jack	⑦ Other specifications A two-digit character is added to indicate other specifications as needed.
④ Number of contacts : 4, 6, 8, 12, 16, 20	

Plug

● Solder termination (contacts inserted)

Shell size: 7

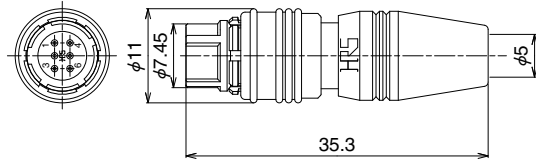

Shell size: 9

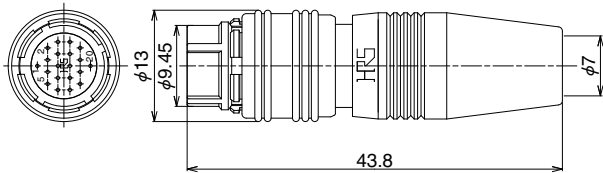

All dimensions: mm

Shell size	No. of contacts	Male contact type		Female contact type	
		Part No.	HRS No.	Part No.	HRS No.
7	4	HR25A-7P-4P	125-0612-1	HR25A-7P-4S	125-0613-4
	6	HR25A-7P-6P	125-0602-8	HR25A-7P-6S	125-0611-9
	8	HR25A-7P-8P	125-0609-7	HR25A-7P-8S	125-0610-6
9	12	HR25A-9P-12P	125-0607-1	HR25A-9P-12S	125-0608-4
	16	HR25A-9P-16P	125-0605-6	HR25A-9P-16S	125-0606-9
	20	HR25A-9P-20P	125-0600-2	HR25A-9P-20S	125-0604-3

● Crimp termination (separate contacts required)

Shell size	No. of contacts	Male contact type		Female contact type	
		Part No.	HRS No.	Part No.	HRS No.
9	12	HR25A-9P-12PC	125-0652-6	HR25A-9P-12SC	125-0653-9
	16	HR25A-9P-16PC	125-0650-0	HR25A-9P-16SC	125-0651-3
	20	HR25A-9P-20PC	125-0648-9	HR25A-9P-20SC	125-0649-1

Nov.1.2016 Copyright 2016 HIROSE ELECTRIC CO., LTD. All Rights Reserved.

■ Receptacle

● Solder termination (contacts inserted)

Shell size: 7

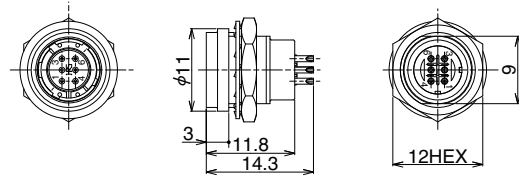

Shell size: 9

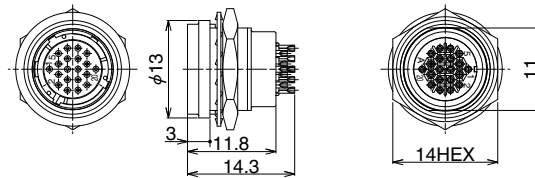

All dimensions: mm

Shell size	No. of contacts	Male contact type		Female contact type	
		Part No.	HRS No.	Part No.	HRS No.
7	4	HR25A-7R-4P	125-0623-8	HR25A-7R-4S	125-0622-5
	6	HR25A-7R-6P	125-0621-2	HR25A-7R-6S	125-0603-0
	8	HR25A-7R-8P	125-0620-0	HR25A-7R-8S	125-0619-0
9	12	HR25A-9R-12P	125-0618-8	HR25A-9R-12S	125-0617-5
	16	HR25A-9R-16P	125-0616-2	HR25A-9R-16S	125-0615-0
	20	HR25A-9R-20P	125-0614-7	HR25A-9R-20S	125-0601-5

● Crimp termination (separate contacts required)

Male contact type
HR25A-9R-20PC

Female contact type
HR25A-9R-20SC

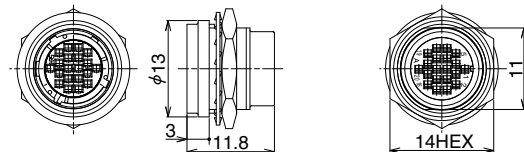
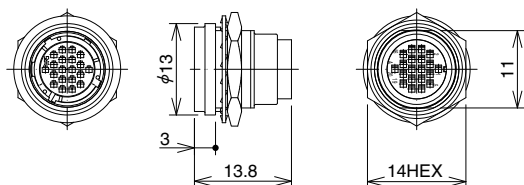

All dimensions: mm

Shell size	No. of contacts	Male contact type		Female contact type	
		Part No.	HRS No.	Part No.	HRS No.
9	12	HR25A-9R-12PC	125-0659-5	HR25A-9R-12SC	125-0658-2
	16	HR25A-9R-16PC	125-0657-0	HR25A-9R-16SC	125-0656-7
	20	HR25A-9R-20PC	125-0654-1	HR25A-9R-20SC	125-0655-4

■ Receptacle

● Through hole (for PC board mounting)

Shell size: 7
HR25A-7R-6SA

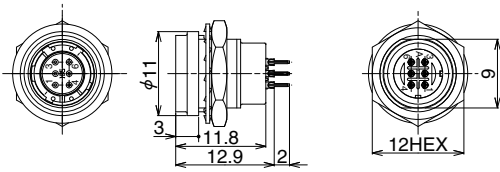

Shell size: 9
HR25A-9R-20SA

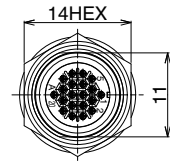
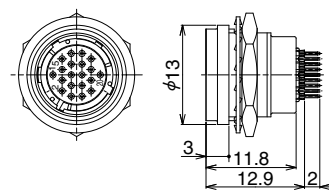

All dimensions: mm

Shell size	No. of contacts	Male contact type		Female contact type	
		Part No.	HRS No.	Part No.	HRS No.
7	4	HR25A-7R-4PA	125-0647-6	HR25A-7R-4SA	125-0646-3
	6	HR25A-7R-6PA	125-0645-0	HR25A-7R-6SA	125-0644-8
	8	HR25A-7R-8PA	125-0643-5	HR25A-7R-8SA	125-0642-2
9	12	HR25A-9R-12PA	125-0641-0	HR25A-9R-12SA	125-0640-7
	16	HR25A-9R-16PA	125-0639-8	HR25A-9R-16SA	125-0638-5
	20	HR25A-9R-20PA	125-0637-2	HR25A-9R-20SA	125-0636-0

■ Jack

● Solder termination (contact inserted)

Shell size: 7
HR25A-7J-6S

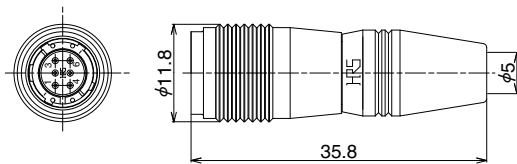

Shell size: 9
HR25A-9J-20S

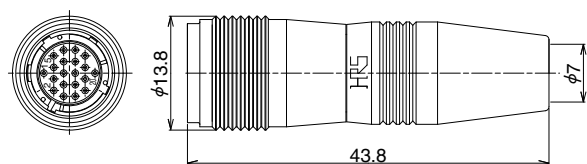

All dimensions: mm

Shell size	No. of contacts	Male contact type		Female contact type	
		Part No.	HRS No.	Part No.	HRS No.
7	4	HR25A-7J-4P	125-0635-7	HR25A-7J-4S	125-0634-4
	6	HR25A-7J-6P	125-0633-1	HR25A-7J-6S	125-0632-9
	8	HR25A-7J-8P	125-0631-6	HR25A-7J-8S	125-0630-3
9	12	HR25A-9J-12P	125-0629-4	HR25A-9J-12S	125-0628-1
	16	HR25A-9J-16P	125-0627-9	HR25A-9J-16S	125-0626-6
	20	HR25A-9J-20P	125-0625-3	HR25A-9J-20S	125-0624-0

● Crimp termination (separate contacts required)

Shell size	No. of contacts	Male contact type		Female contact type	
		Part No.	HRS No.	Part No.	HRS No.
9	12	HR25A-9J-12PC	125-0665-8	HR25A-9J-12SC	125-0664-5
	16	HR25A-9J-16PC	125-0663-2	HR25A-9J-16SC	125-0662-0
	20	HR25A-9J-20PC	125-0661-7	HR25A-9J-20SC	125-0660-4

◆ Crimp contact

Male contact

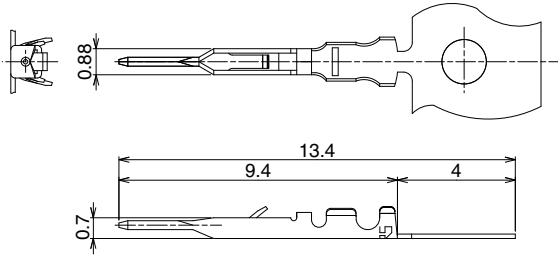

Female contact

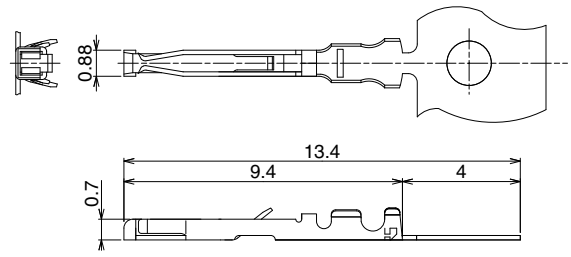

All dimensions: mm

Type	Part No.	HRS No.	Conductor size / construction	Type	Part No.	HRS No.	Conductor size / construction
Loose contact	HR25-PC-111	125-0419-1	AWG#30	Loose contact	HR25-SC-111	125-0421-3	AWG#30
Reel contact	HR25-PC-211	125-0420-0		Reel contact	HR25-SC-211	125-0422-6	

Note 1 : Wire jacket outer diameter 0.71 mm max.

Note 2 : Loose piece contacts are packaged 100 pcs/pack. Reel contacts are packaged 10,000 pcs/reel.

◆ Applicable tools

Type	Part No.	HRS No.	Used on
Manual contact crimping tool	HR25-TA3032HC	150-0207-3	HR25-PC-111 or HR25-SC-111
Automatic crimping machine	CM-105	901-0005-4	—
Applicator	AP105-HR25-1	901-2040-6	HR25-PC-211 or HR25-SC-211
Cable clamp crimp tool	HR10A-TC-02	150-0041-2	—
Solder termination fixture	HR25A-7P-T02	150-0243-7	HR25A-7P
	HR25-7P-T01	150-0085-8	HR25A-7P
Plug shell tightening fixture	HR25A-9P-T02	150-0242-4	HR25A-9P
	HR25-9P-T01	150-0086-0	HR25A-9P
Contact extraction tool	HR25-TP	150-0091-0	—

◆ Panel cutouts

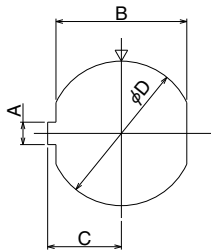

All dimensions: mm

Dimensions	HR25A-7R	HR25A-9R
A	1.55 ^{+0.05} ₀	
B	9.05 ^{+0.03} _{-0.02}	11.05 ^{+0.03} _{-0.02}
C	5.1 ^{+0.1} ₀	6.1 ^{+0.1} ₀
D	10 ^{+0.05} ₀	12 ^{+0.05} ₀
Applicable panel thickness	0.7 to 2	

Note 1: The receptacle panel cutout is a view from the mating side.

◆ PCB mounting pattern (for through-hole PC board mounting)

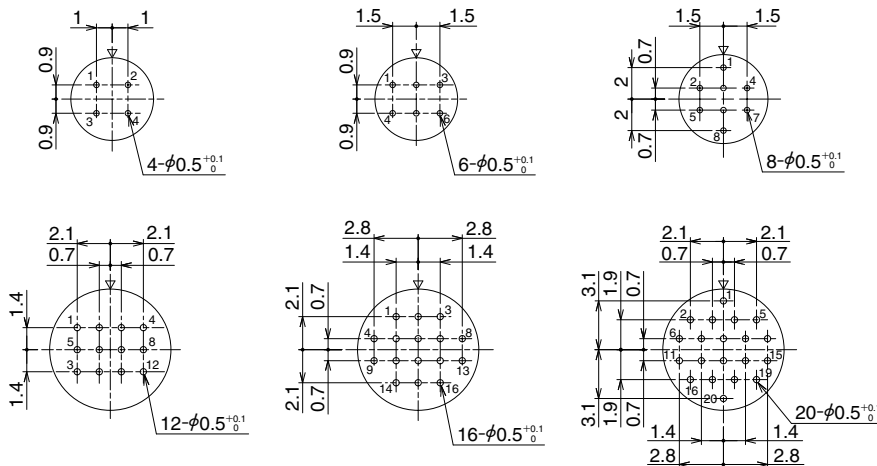

Note 1: The above diagrams are viewed from the engagement side of the socket insert (i.e., the wiring side of the pin insert).

Note 2: The ▽ mark of the above diagrams indicates the engagement guide key position.

Note 3: Plated through hole location and diameter tolerance: ±0.05.

◆ Contact Position Arrangement

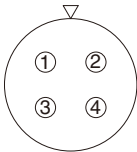
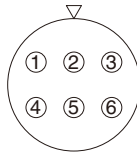
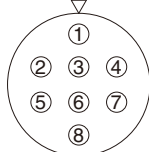
Shell size	Size 7		
Contact configuration			
No. of contacts	4	6	8
Withstand voltage	100 V AC for 1 minute		
Current capacity	1A		
Insulation resistance	1,000 MΩ or greater		
Contact resistance	30 mΩ		
Solderpot inner diameter	0.5mm dia.		

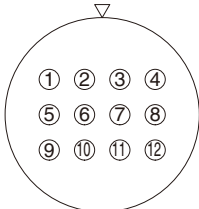
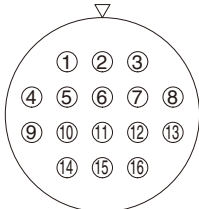
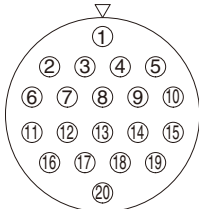
Shell size	Size 9		
Contact configuration			
No. of contacts	12	16	20
Withstand voltage	100 V AC for 1 minute		
Current capacity	1A		
Insulation resistance	1,000 MΩ or greater		
Contact resistance	30 mΩ		
Solderpot inner diameter	0.5mm dia.		

Note 1: The above diagrams are viewed from the engagement side of the socket insert (i.e., the wiring side of the pin insert).

Note 2: The ▽ mark of the above diagrams indicates the engagement guide key position.

Note 3: The withstand voltage indicates the test voltage value. For regular use the voltage used should be less than 30 V AC or 42 V DC.

Note 4: The current capacity of the crimp terminals indicates the value when using wire of AWG #30.

Note 5: The insulation resistance indicates a value when measured at 100 V DC.

◆ Precautions

1. Switch off the power of the circuit before disconnecting or plugging-in the connectors.
2. Use connectors with socket contacts at the power side of the circuit.
3. Make sure that the coupling is in completely cocked position.
4. Cable clamping, cable rotation, and other forces may vary with the cable construction.
Please make sure that your cable is suitable for use with these connectors before usage and production.

USA:

HIROSE ELECTRIC (U.S.A.), INC. HEADQUARTERS
 2688 Westhills Court, Simi Valley, CA 93065-6235
 Phone : +1-805-522-7958
 Fax : +1-805-522-3217
<http://www.hirose.com/us/>

USA:

HIROSE ELECTRIC (U.S.A.), INC. SAN JOSE OFFICE
 3255 Scott Boulevard, Building 7, Suite 101
 Santa Clara, CA 95054
 Phone : +1-408-253-9640
 Fax : +1-408-253-9641
<http://www.hirose.com/us/>

USA:

HIROSE ELECTRIC (U.S.A.), INC. CHICAGO OFFICE
 580 Waters Edge Lane, Suite 205 Lombard IL
 60148
 Phone : +1-630-282-6706
 Mail : inquiries@hirose.com
<http://www.hirose.com/us/>

USA:

HIROSE ELECTRIC (U.S.A.), INC. DETROIT OFFICE (AUTOMOTIVE)
 37677 Professional Center Drive, Suite #100C
 Livonia, MI 48154
 Phone : +1-734-542-9963
 Fax : +1-734-542-9964
<http://www.hirose.com/us/>

THE NETHERLANDS:

HIROSE ELECTRIC EUROPE B.V.
 Hogehillweg #8 1101 CC Amsterdam Z-0
 Phone : +31-20-6557460
 Fax : +31-20-6557469
<http://www.hirose.com/eu/>

GERMANY:

HIROSE ELECTRIC EUROPE B.V. GERMAN BRANCH
 Herzog-Carl-Strasse 4 D-73760 Ostfildern
 (Scharnhäuser Park)
 Phone : +49-711-4560-02-1
 Fax : +49-711-4560-02-299
<http://www.hirose.com/eu/>

GERMANY:

HIROSE ELECTRIC EUROPE B.V. NUERNBERG OFFICE
 Muggenhofer Str. 136 90429 Nuernberg
 Phone : +49-911 32 68 89 63
 Fax : +49-911 32 68 89 69
<http://www.hirose.com/eu/>

UNITED KINGDOM:

HIROSE ELECTRIC EUROPE BV (UK BRANCH)
 4 Newton Court, Kelvin Drive, Knowlhill,
 Milton Keynes, MK5 8NH
 Phone : +44-1908 202050
 Fax : +44-1908 202058
<http://www.hirose.com/eu/>

CHINA:

HIROSE ELECTRIC (SHANGHAI) CO., LTD.
 1601, Henderson Metropolitan, NO.300, East Nanjing
 Road, Huangpu District, Shanghai, China 200001
 Phone : +86-21-6391-3355
 Fax : +86-21-6391-3335
<http://www.hirose.com/cn/>

CHINA:

HIROSE ELECTRIC (SHANGHAI) CO.,LTD. BEIJING BRANCH
 A1001, Ocean International Center, Building 56# East 4th
 Ring Middle Road, ChaoYang District, Beijing, 100025
 Phone : +86-10-5165-9332
 Fax : +86-10-5908-1381
<http://www.hirose.com/cn/>

CHINA:

HIROSE ELECTRIC TECHNOLOGIES (SHENZHEN) CO., LTD.
 Room 09-13, 19/F, Office Tower Shun Hing Square, Di Wang Commercial Centre,
 5002 Shen Nan Dong Road, Shenzhen City, Guangdong Province, 518008
 Phone : +86-755-8207-0851
 Fax : +86-755-8207-0873
<http://www.hirose.com/cn/>

HONG KONG:

HIROSE ELECTRIC HONGKONG TRADING CO., LTD.
 Room 1001, West Wing, Tsim Sha Tsui Centre, 66
 Mody Road, Tsim Sha Tsui East, Kowloon, Hong Kong
 Phone : +852-2803-5338
 Fax : +852-2591-6560
<http://www.hirose.com/hk/>

TAIWAN:

HIROSE ELECTRIC TAIWAN CO., LTD.
 103 8F, No.87, Zhengzhou Rd., Taipei
 Phone : +886-2-2555-7377
 Fax : +886-2-2555-7350
<http://www.hirose.com/cn/>

KOREA:

HIROSE KOREA CO., LTD.
 1261-10, Jeoungwhang-Dong, Shihung-City,
 Kyunggi-Do 429-450
 Phone : +82-31-496-7000,7124
 Fax : +82-31-496-7100
<http://www.hirose.co.kr/>

SINGAPORE:

HIROSE ELECTRIC SINGAPORE PTE. LTD.
 10 Anson Road #26-1, International Plaza
 079903, Singapore
 Phone : +65-6324-6113
 Fax : +65-6324-6123
<http://www.hirose.com/sg/>

INDIA:

HIROSE ELECTRIC SINGAPORE PTE. LTD. DELHI LIAISON OFFICE
 Office NO.519, Regus-Green Boulevard, Level5, Tower C,
 Sec62, Plot B-9A, Block B, Noida, 201301, Uttar Pradesh, India
 Phone : +91-12-660-8018
 Fax : +91-120-4804949
<http://www.hirose.com/sg/>

INDIA:

HIROSE ELECTRIC SINGAPORE PTE. LTD. BANGALORE LIAISON OFFICE
 Unit No.03, Ground Floor, Explorer Building International Tech
 Park Whitefield Road, Bangalore 560066 Karnataka, India
 Phone : +91-80-4120 1907
 Fax : +91-80-4120 9908
<http://www.hirose.com/sg/>

MALAYSIA:

HIROSE ELECTRIC SINGAPORE PTE. LTD. (REPRESENTATIVE OFFICE)
 1-10-07, Suntech @ Penang Cybercity (1164),Lintang
 Mayang Pasir 3,11950, Bayan Baru, Penang, Malaysia.
 Phone : +604-619-2564
 Fax : +604-619-2574
<http://www.hirose.com/sg/>



HIROSE ELECTRIC CO.,LTD.

2-6-3,Nakagawa Chuoh,Tsuzuki-Ku,Yokohama-Shi 224-8540,JAPAN
 TEL: +81-45-620-3526 Fax: +81-45-591-3726
<http://www.hirose.com>
<http://www.hirose-connectors.com>