

UP TO 3 POSITIONS WITH 3 OPTIONAL, INDEPENDENT LED LIGHT POSITIONS

Used in the heavy equipment, marine, process control and instrumentation markets, the R2 rotary switch is an excellent replacement for rocker switches, offering improved visual position indication, additional lighting options and different styling opportunities on front panels. The R2 is a sealed, lighted rotary switch which snaps into a 1.475" x 0.875" industry standard rocker switch panel opening. The rotary knob snaps onto a shaft and can be installed by the panel builder for those desiring that flexibility. The R2 rotary switch provides up to three positions in all combinations of momentary and maintained action. It is capable of handling loads from logic level up to 20 amps resistive. Sealing is to IP68S via a shaft O-ring seal in front and a potted base in the back. Termination options include 0.250" faston or a snap-on modular connector. The R2 offers unique lighting options including up to three independent LED light positions which illuminate a lens on the rotary knob. This design provides more lighting options than traditional rocker switches, handles the full range of electrical loads and is robust enough to survive in the most demanding applications.



Features:

- **Sealed watertight per IP68S**
- **Snap-in panel mounting into industry standard 1.475" x 0.875" panel cutout**
- **Unique lighting options—up to three independent LED light positions**
- **Plastic or Soft Touch knob options available**
- **2 or 3 positions in all combinations of momentary & maintained action**
- **Termination can be used as 0.250" faston or with snap-on modular connector**

Standard Characteristics/Ratings:		
ELECTRICAL RATINGS:		
Load	Sea Level @ 12/28VDC	Sea Level @ 110VAC
Resistive	20A	16A
Inductive	15A	15A
Lamp	4A	4A
Motor	N/A	0.5HP
DWV	1050Vrms	
Low Level	10mA @ 30mV	
Electrical Life:	25,000 cycles at full load	
Lighting:	LED 2V, 6V, 12V, 24V (VDC)	
Mechanical Life:	100,000 cycles	
Seal:	IP68S	
Operating Temp Range:	-40°C to +85°C	
MATERIALS:		
Case:	Thermoplastic	
Knob:	Thermoplastic	
Lens:	Thermoplastic, clear	
Terminals:	Copper, silver plate, gold plate for low level	
Contacts:	Silver alloy, gold plate for low level	
Terminal Hardware:	R2 recommended Quick Connect terminals: AMP 60253-2 for 12-16 AWG AMP 42100-2 for 14-18 AWG	
Mounting Hardware:	None provided	

ROTARY SWITCH

UP TO 3 POSITIONS WITH 3 OPTIONAL, INDEPENDENT LED LIGHT POSITIONS

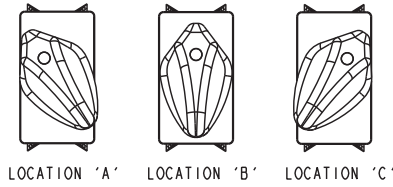
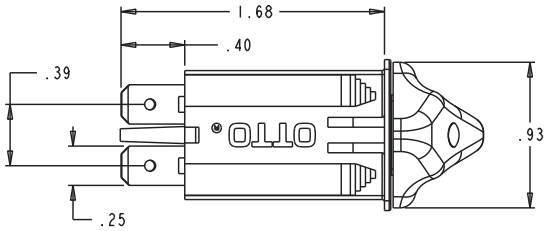

Knob Location Details

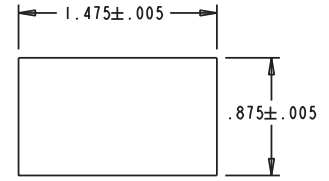

Panel Opening Detail

PANEL THICKNESS: .025 MIN. TO .187 MAX.

ELECTRICAL SCHEMATICS

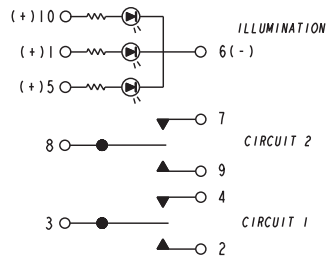

Generic Switch Schematic
USE TERMINALS AS APPLICABLE TO PART NUMBER

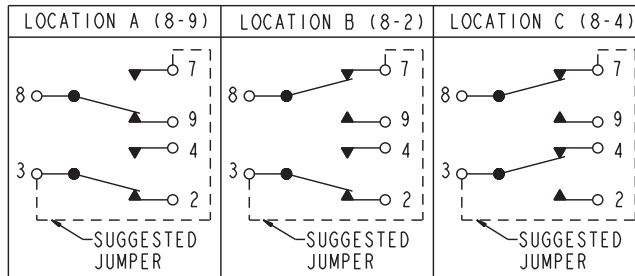

SPT Schematic

USE R2XXXX77XXXX FOR (8-9), (8-2), (8-4)
USE R2XXXX74XXXX FOR (OFF), (8-2), (8-4)
USE R2XXXX67XXXX FOR (8-9), (8-2), (OFF)

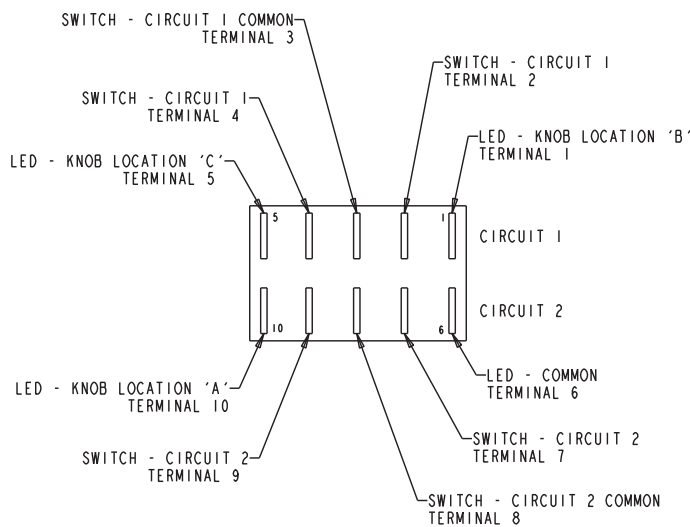

Terminal Location as Viewed from the Bottom of the Switch

Optional Connector Key

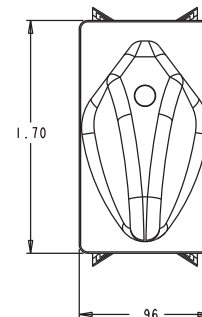
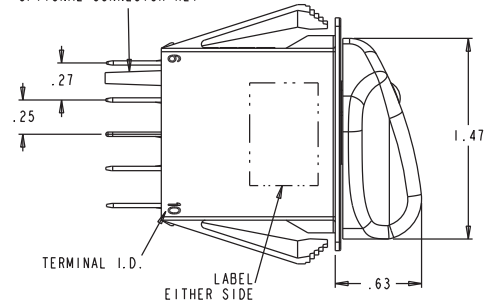

ROTARY SWITCH

UP TO 3 POSITIONS WITH 3 OPTIONAL, INDEPENDENT LED LIGHT POSITIONS

R2 SERIES PART NUMBER CODE

R2	X	X	XX	X	X	X	X	X	X	X					
Terminal Style/ Switch Rating	Knob Color & Texture	Switch Action			Switch Circuit 1 Terminals 2, 3, 4			Switch Circuit 2 Terminals 7, 8, 9			LED Light Source Voltage	Light Source Color			
		Knob Location "A"	Knob Location "B"	Knob Location "C"	Knob Location "A"	Knob Location "B"	Knob Location "C"	Knob Location "A"	Knob Location "B"	Knob Location "C"		Location "A"	Location "B"	Location "C"	
A. Without Terminal Barriers With Connector Keying Pin/Std. Rating	A. Black Plastic Soft	2-Position Switch, Knob Locations A/B			2-Position Switch, Knob Locations A/B			N. None (Single Pole)			N. None	N. None	N. None	N. None	N. None
B. Without Terminal Barriers Without Connector Keying Pin/Std. Rating	B. Black Touch	11. Maintain	Maintain	N/A	1. 3-2	OFF	N/A	1. 8-9	OFF	N/A	A. 2V	1. Red	1. Red	1. Red	
C. Without Terminal Barriers With Connector Keying Pin/Low Level Rating	C. White Plastic	12. Maintain	Momentary	N/A	2. OFF	3-4	N/A	2. OFF	8-7	N/A	B. 6V	2. Green	2. Green	2. Green	
D. Without Terminal Barriers Without Connector Keying Pin/Low Level Rating	D. White Soft Touch	13. Momentary	Maintain	N/A	3. 3-2	3-4	N/A	3. 8-9	8-7	N/A	C. 12V	3. Amber	3. Amber	3. Amber	
		2-Position Switch, Knob Locations A/C			2-Position Switch, Knob Locations A/C			2-Position Switch, Knob Locations A/B							
		21. Maintain	N/A	Maintain	1. 3-2	N/A	OFF	1. 8-9	N/A	OFF					
		22. Maintain	N/A	Momentary	2. OFF	N/A	3-4	2. OFF	N/A	8-7					
		23. Momentary	N/A	Maintain	3. 3-2	N/A	3-4	3. 8-9	8-7	8-7					
		2-Position Switch, Knob Locations B/C			2-Position Switch, Knob Locations B/C			2-Position Switch, Knob Locations A/C							
		31. N/A	Maintain	Maintain	1. N/A	3-2	OFF	1. N/A	8-9	N/A	OFF				
		32. N/A	Maintain	Momentary	2. N/A	OFF	3-4	2. OFF	N/A	8-7					
		33. N/A	Momentary	Maintain	3. N/A	3-2	3-4	3. N/A	8-9	8-7					
		3-Position Switch, Knob Locations A/B/C			3-Position Switch			2-Position Switch, Knob Locations B/C							
		44. Maintain	Maintain	Maintain	4. OFF	3-4	3-4	1. N/A	8-9	OFF					
		45. Momentary	Maintain	Momentary	5. 3-2	OFF	3-4	2. OFF	N/A	8-7					
		46. Maintain	Maintain	Momentary	6. 3-2	3-2	OFF	3. 8-9	8-9	OFF					
		47. Momentary	Maintain	Maintain	7. 3-2	3-2	3-4	4. OFF	8-7	8-7					
					8. 3-2	OFF	OFF	5. 8-9	OFF	8-7					
					9. OFF	OFF	3-4	6. 8-9	8-9	OFF					
								7. 8-9	8-7	8-7					
								8. 8-9	OFF	OFF					
								9. OFF	OFF	8-7					

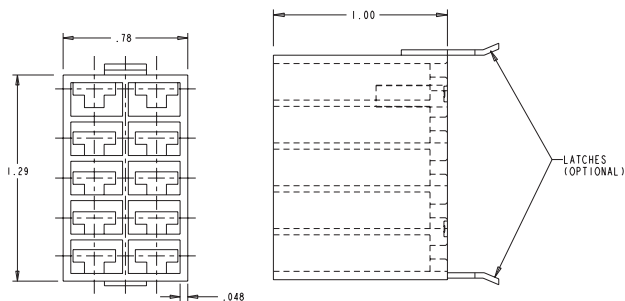

R2 Connector
P/N 801775-2A Without Latches
P/N 801775-2B With Latches

Recommended Quick Connect Terminals
AMP 60253-2 for 12-16 AWG
AMP 42100-2 for 14-18 AWG

Panel Seal Gasket
P/N 807109