

TPD2005F

High-Side Power Switch Array (8 Channels) for Motors, Solenoids, and Lamp Drivers

The TPD2005F is an 8-channel high-side switch array for vertical power MOSFET output. A monolithic power IC, it can directly drive a power load from a CMOS or TTL logic circuit (such as an MPU). It offers overcurrent and overtemperature protection functions.

Features

- A high-side switch array incorporating an N-channel power MOSFET (1.2 Ωmax.) and an 8-channel charge pump
- Can directly drive a power load from a microprocessor.
- Built-in protection against overtemperature protection and overcurrent protection
- 8-channel access enables space-saving design
- High operating supply voltage : 40 V
- Low on resistance : 1.2 Ω max. (@V_{DD} = 12 V, I_O = 0.5 A (per channel))
- Supports parallel operation.
- Low supply current : 5 mA max. (@V_{DD} = 40 V, V_{IN} = 0 V)
- Supplied in an SSOP-24 package (300 mil) in embossed taping.

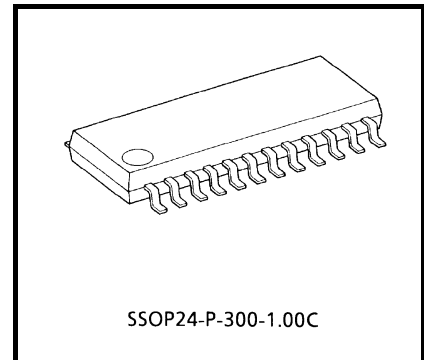

Weight: 0.29g (typ.)

Pin Assignment

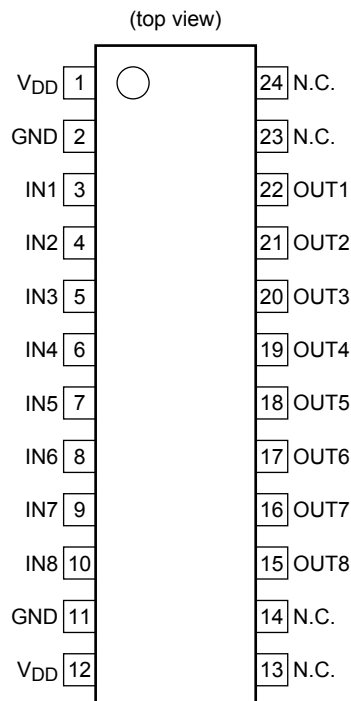

Marking

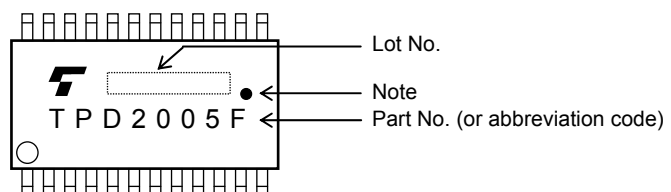

Note : A dot marking for identifies the indication of product Labels.

Without a dot: [[Pb]]/INCLUDES > MCV

With a dot: [[G]]/RoHS COMPATIBLE or [[G]]/RoHS [[Pb]]

Please contact your TOSHIBA sales representative for details as to environmental matters such as the RoHS compatibility of Product.

The RoHS is the Directive 2011/65/EU of the European Parliament and of the Council of 8 June 2011 on the restriction of the use of certain hazardous substances in electrical and electronic equipment.

Note: Due to its MOS structure, this product is sensitive to static electricity.

Start of commercial production
1999-05

Pin Description

Pin No.	Symbol	Description
1	V _{DD}	Power supply pin; in common with the pin No.12 internally.
2	GND	GND pin; in common with the pin No.11 internally.
3	IN1	Control input pin for channel 1 and built-in pull-down resistor (100 kΩ typ.)
4	IN2	Control input pin for channel 2 and built-in pull-down resistor (100 kΩ typ.)
5	IN3	Control input pin for channel 3 and built-in pull-down resistor (100 kΩ typ.)
6	IN4	Control input pin for channel 4 and built-in pull-down resistor (100 kΩ typ.)
7	IN5	Control input pin for channel 5 and built-in pull-down resistor (100 kΩ typ.)
8	IN6	Control input pin for channel 6 and built-in pull-down resistor (100 kΩ typ.)
9	IN7	Control input pin for channel 7 and built-in pull-down resistor (100 kΩ typ.)
10	IN8	Control input pin for channel 8 and built-in pull-down resistor (100 kΩ typ.)
11	GND	GND pin; in common with the pin No.2 internally.
12	V _{DD}	Power supply pin; in common with the pin No.1 internally.
13	N.C.	—
14	N.C.	—
15	OUT8	Output pin for channel 8
16	OUT7	Output pin for channel 7
17	OUT6	Output pin for channel 6
18	OUT5	Output pin for channel 5
19	OUT4	Output pin for channel 4
20	OUT3	Output pin for channel 3
21	OUT2	Output pin for channel 2
22	OUT1	Output pin for channel 1
23	N.C.	—
24	N.C.	—

Timing Chart

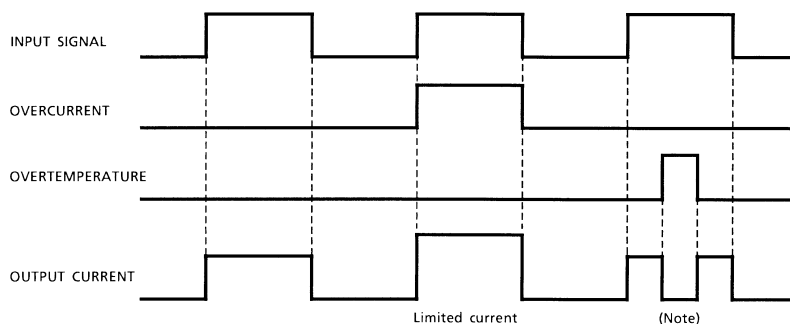

Note: The overtemperature detector circuits feature hysteresis. After overtemperature is detected, normal operation is restored only when the junction temperature falls by the hysteresis amount (10°C typ.) in relation to the overtemperature detection temperature.

Truth Table

Input Signal	Output Signal	State
L	L	Normal
H	H	
L	L	Overcurrent
H	Internally limited	
L	L	Overtemperature
H	L	

Absolute Maximum Ratings (Ta = 25°C)

Characteristic	Symbol	Rating	Unit
Supply voltage	V _{DD}	45	V
Input voltage	V _{IN}	- 0.5 to 7	V
Drain-source voltage	V _{DS}	60	V
Output current	I _O	Internally limited	A
Power dissipation (operating all channels, Ta = 25°C)	P _T	0.8	W
		1.2 (Note 1)	
Single pulse avalanche energy	E _{AS}	10	mJ
Operating temperature	T _{opr}	- 40 to 85	°C
Junction temperature	T _j	150	°C
Storage temperature	T _{stg}	- 55 to 150	°C

Note: Using continuously under heavy loads (e.g. the application of high temperature/current/voltage and the significant change in temperature, etc.) may cause this product to decrease in the reliability significantly even if the operating conditions (i.e. operating temperature/current/voltage, etc.) are within the absolute maximum ratings and the operating ranges.

Please design the appropriate reliability upon reviewing the Toshiba Semiconductor Reliability Handbook ("Handling Precautions"/"Derating Concept and Methods") and individual reliability data (i.e. reliability test report and estimated failure rate, etc).

Thermal Characteristics

Characteristic	Symbol	Rating	Unit
Thermal resistance junction to ambient (Operating all channels, Ta = 25°C)	ΣR _{th(j-a)}	156.3	°C / W
		104.2 (Note 1)	

Note 1: 60 mm × 60 mm × 1.6 mm when a device is mounted on a glass epoxy PCB (DC).

Electrical Characteristics

(Unless otherwise specified, $V_{DD} = 8$ to $40V$, $T_j = 25^\circ C$)

Characteristic	Symbol	Test Circuit	Test Condition	Min	Typ.	Max	Unit
Operating supply voltage	$V_{DD(opr)}$	—	—	8	—	40	V
Supply current	I_{DD}	—	$V_{DD} = 40 V, V_{IN} = 0 V$	—	—	5	mA
Input voltage	"L" level	V_{IL}	—	—	—	1.5	V
	"H" level	V_{IH}	—	3.5	—	—	
Input current	I_{IL}	—	$V_{DD} = 24 V, V_{IN} = 0 V$	-10	—	10	μA
	I_{IH}	—	$V_{DD} = 24 V, V_{IN} = 5 V$	—	50	200	
On resistance	$R_{DS(ON)}$	—	$V_{DD} = 12 V, I_O = 0.5 A$	—	0.9	1.2	Ω
Output leakage current	I_{OL}	—	$V_{DD} = 40 V, V_{IN} = 0 V$	—	—	100	μA
Overcurrent protection	I_S	—	—	1	—	3	A
Overtemperature detection	Temperature	T_{SD}	—	—	160	—	$^\circ C$
	Hysteresis	ΔT_{SD}	—	—	10	—	
Switching time	t_{ON}	1	$V_{DD} = 12 V, R_L = 24 \Omega$	—	11	200	μs
	t_{OFF}			—	4	50	

Description of Protector Circuit

(1) Overtemperature Protection

- There are four built-in overtemperature detector circuits, one each for channels 1 and 2; channels 3 and 4; channels 5 and 6; and channels 7 and 8, respectively. The circuit logic is such that, when any of the four detectors detects overtemperature, the circuit turns off the output of both its channels (for example, both channels 1 and 2).
- The overtemperature detector circuits feature hysteresis. After overtemperature is detected, normal operation is restored only when the junction temperature falls by the hysteresis amount ($10^\circ C$ typ.) in relation to the overtemperature detection temperature.

(2) Overcurrent Protection

- When overcurrent is detected, the overcurrent limiter function limits the output current. Normal operation is restored when the load current drops below the overcurrent detection value.

Test Circuit

Switching Time

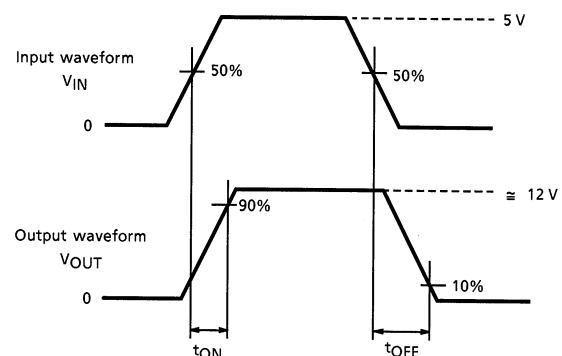
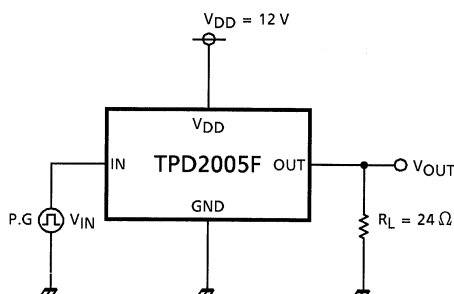

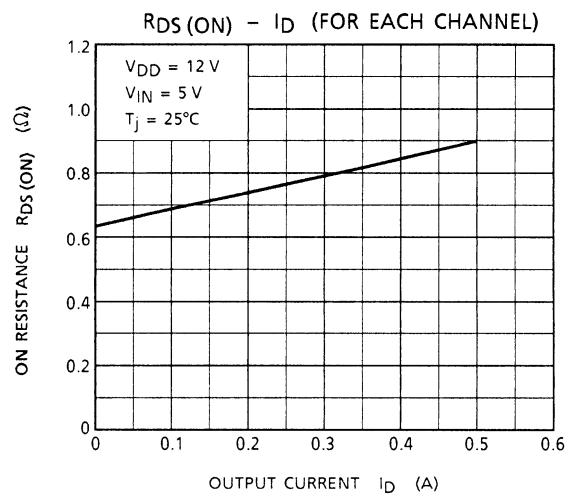
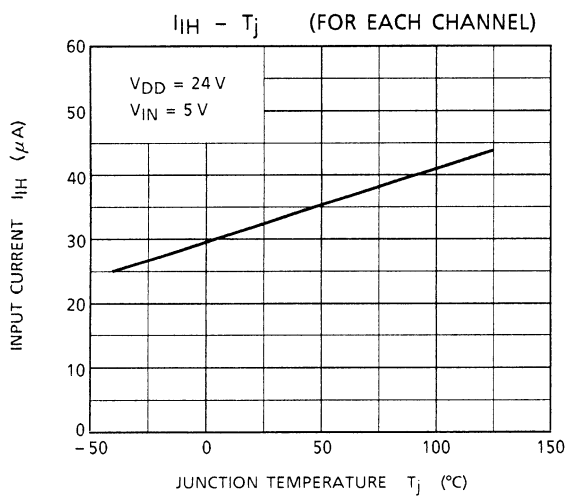
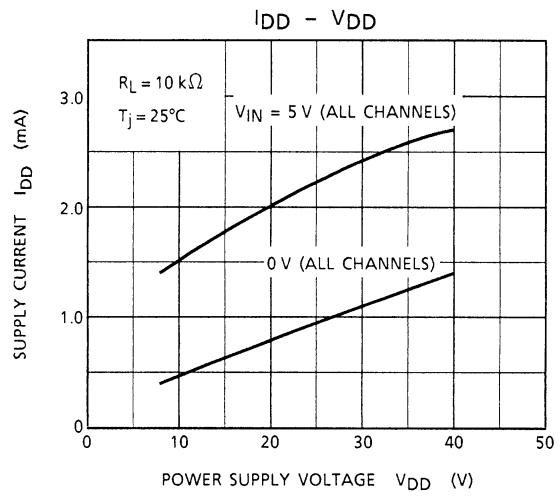
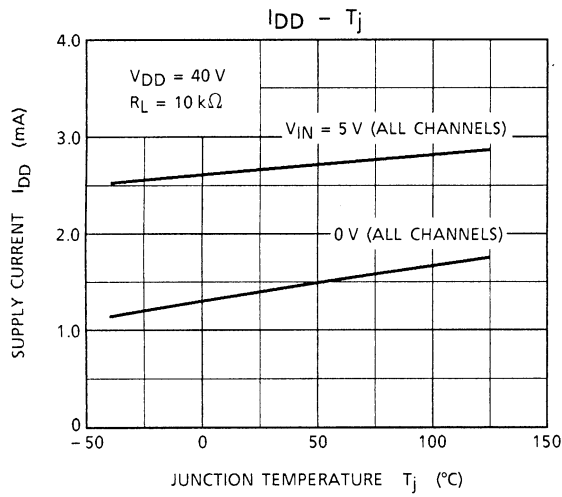
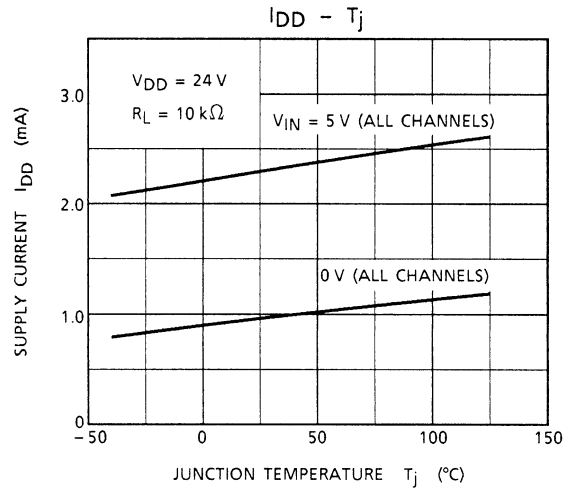
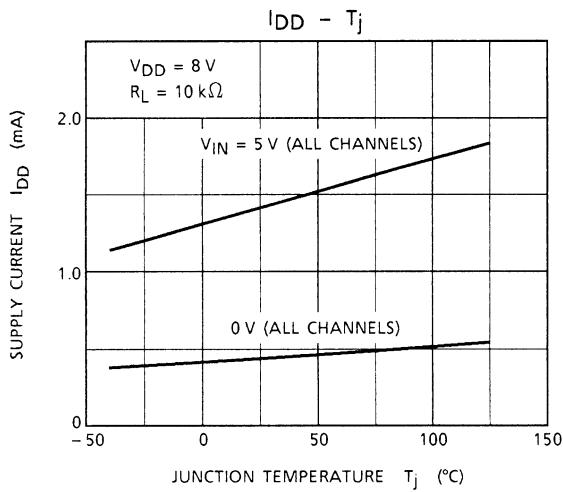

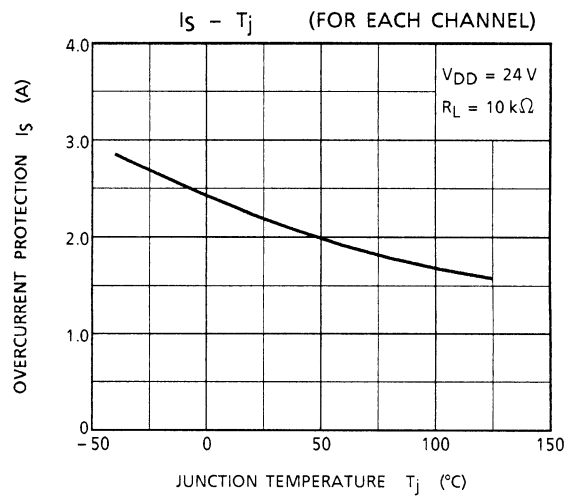
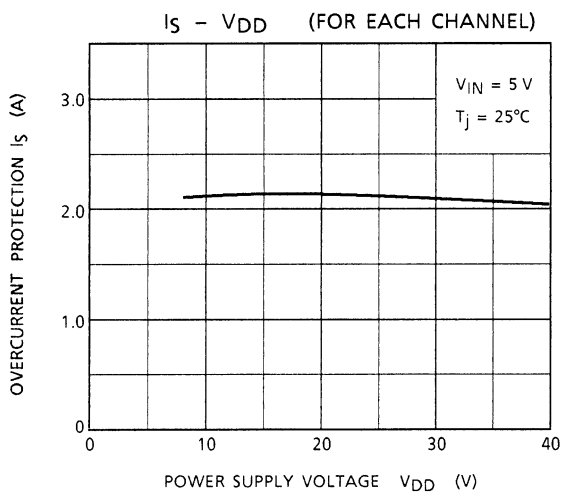
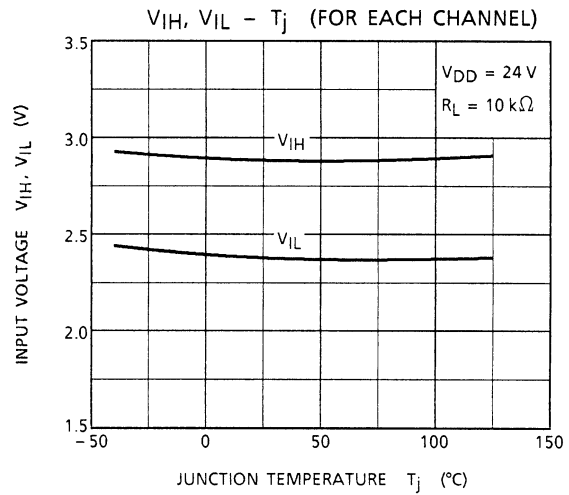
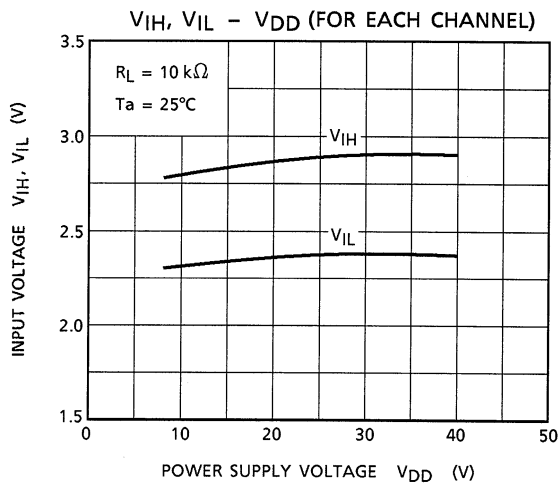
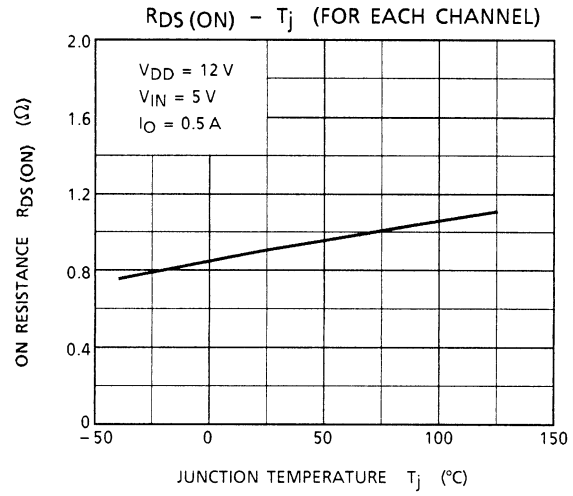
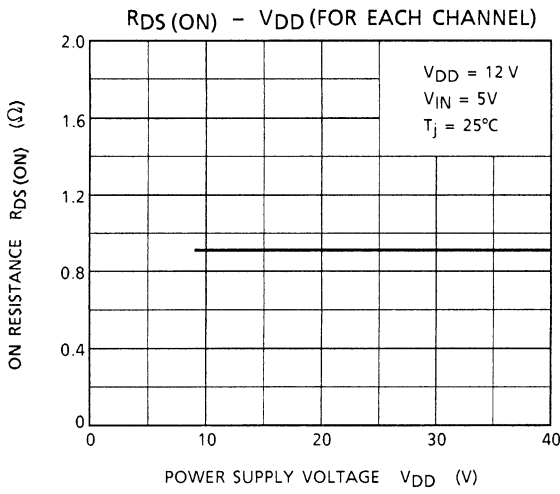

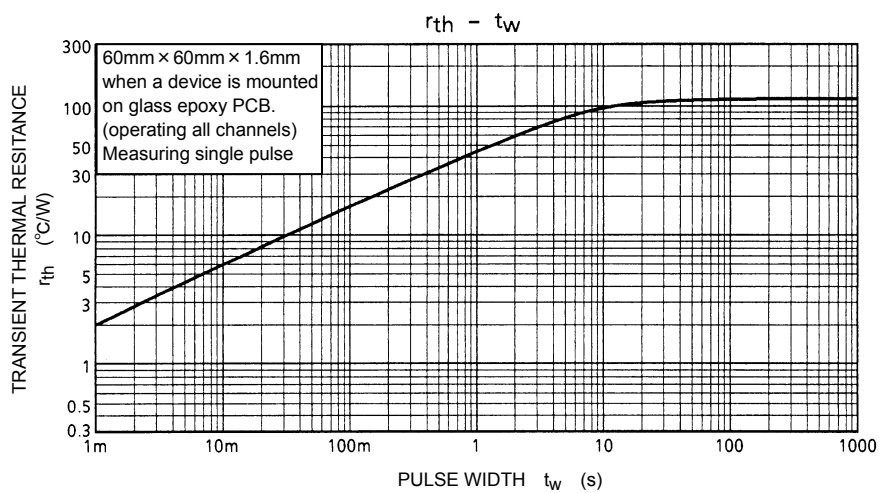
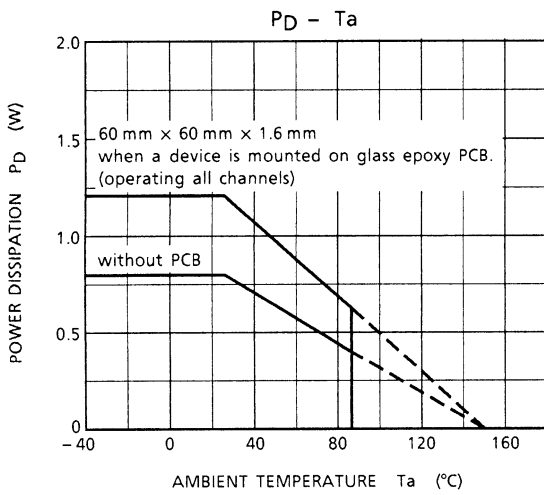
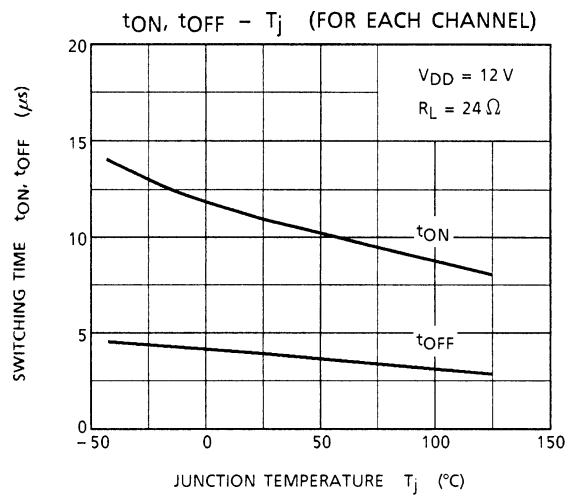
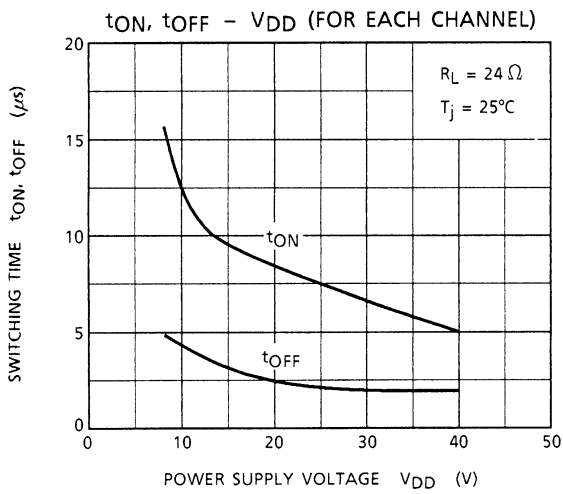

Caution on Usage

1. As protection against reverse connection of batteries is not provided, take protective measures using external circuits.
2. As a negative bias protector circuit is not built into the output pins, if negative bias is applied to the output pins, be sure to connect a freewheel diode between OUT and GND.

Moisture-Proof Packing

After the pack is opened, use the devices in a 30°C, 60% RH environment, and within 48 hours.

Embossed-tape packing cannot be baked. Devices so packed must be within their allowable time limits after unpacking, as specified on the packing.

Standard tape packing quantity: 2000 devices / reel (EL1)

Package Dimensions

SSOP24-P-300-1.00C

Unit: mm

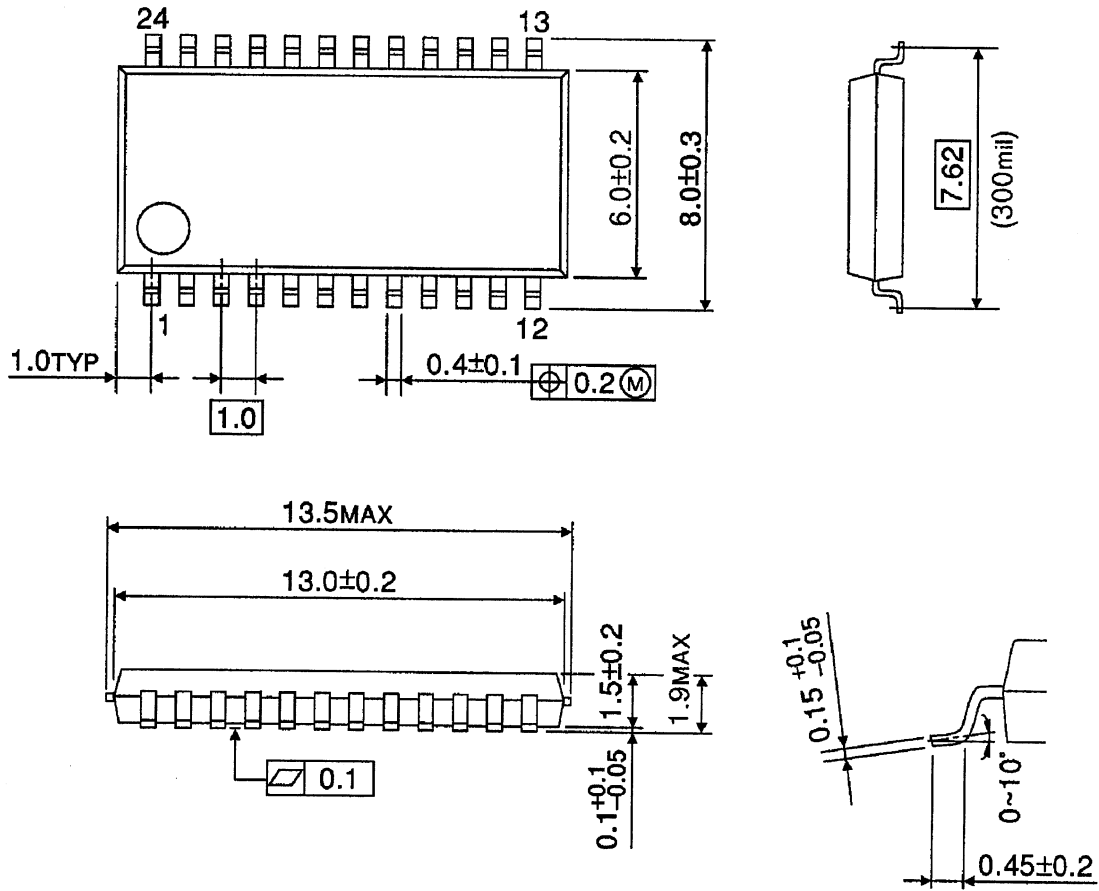

Weight: 0.29g (typ.)

RESTRICTIONS ON PRODUCT USE

- Toshiba Corporation, and its subsidiaries and affiliates (collectively "TOSHIBA"), reserve the right to make changes to the information in this document, and related hardware, software and systems (collectively "Product") without notice.
- This document and any information herein may not be reproduced without prior written permission from TOSHIBA. Even with TOSHIBA's written permission, reproduction is permissible only if reproduction is without alteration/omission.
- Though TOSHIBA works continually to improve Product's quality and reliability, Product can malfunction or fail. Customers are responsible for complying with safety standards and for providing adequate designs and safeguards for their hardware, software and systems which minimize risk and avoid situations in which a malfunction or failure of Product could cause loss of human life, bodily injury or damage to property, including data loss or corruption. Before customers use the Product, create designs including the Product, or incorporate the Product into their own applications, customers must also refer to and comply with (a) the latest versions of all relevant TOSHIBA information, including without limitation, this document, the specifications, the data sheets and application notes for Product and the precautions and conditions set forth in the "TOSHIBA Semiconductor Reliability Handbook" and (b) the instructions for the application with which the Product will be used with or for. Customers are solely responsible for all aspects of their own product design or applications, including but not limited to (a) determining the appropriateness of the use of this Product in such design or applications; (b) evaluating and determining the applicability of any information contained in this document, or in charts, diagrams, programs, algorithms, sample application circuits, or any other referenced documents; and (c) validating all operating parameters for such designs and applications. **TOSHIBA ASSUMES NO LIABILITY FOR CUSTOMERS' PRODUCT DESIGN OR APPLICATIONS.**
- **PRODUCT IS NEITHER INTENDED NOR WARRANTED FOR USE IN EQUIPMENTS OR SYSTEMS THAT REQUIRE EXTRAORDINARILY HIGH LEVELS OF QUALITY AND/OR RELIABILITY, AND/OR A MALFUNCTION OR FAILURE OF WHICH MAY CAUSE LOSS OF HUMAN LIFE, BODILY INJURY, SERIOUS PROPERTY DAMAGE AND/OR SERIOUS PUBLIC IMPACT ("UNINTENDED USE").** Except for specific applications as expressly stated in this document, Unintended Use includes, without limitation, equipment used in nuclear facilities, equipment used in the aerospace industry, medical equipment, equipment used for automobiles, trains, ships and other transportation, traffic signaling equipment, equipment used to control combustions or explosions, safety devices, elevators and escalators, devices related to electric power, and equipment used in finance-related fields. **IF YOU USE PRODUCT FOR UNINTENDED USE, TOSHIBA ASSUMES NO LIABILITY FOR PRODUCT.** For details, please contact your TOSHIBA sales representative.
- Do not disassemble, analyze, reverse-engineer, alter, modify, translate or copy Product, whether in whole or in part.
- Product shall not be used for or incorporated into any products or systems whose manufacture, use, or sale is prohibited under any applicable laws or regulations.
- The information contained herein is presented only as guidance for Product use. No responsibility is assumed by TOSHIBA for any infringement of patents or any other intellectual property rights of third parties that may result from the use of Product. No license to any intellectual property right is granted by this document, whether express or implied, by estoppel or otherwise.
- **ABSENT A WRITTEN SIGNED AGREEMENT, EXCEPT AS PROVIDED IN THE RELEVANT TERMS AND CONDITIONS OF SALE FOR PRODUCT, AND TO THE MAXIMUM EXTENT ALLOWABLE BY LAW, TOSHIBA (1) ASSUMES NO LIABILITY WHATSOEVER, INCLUDING WITHOUT LIMITATION, INDIRECT, CONSEQUENTIAL, SPECIAL, OR INCIDENTAL DAMAGES OR LOSS, INCLUDING WITHOUT LIMITATION, LOSS OF PROFITS, LOSS OF OPPORTUNITIES, BUSINESS INTERRUPTION AND LOSS OF DATA, AND (2) DISCLAIMS ANY AND ALL EXPRESS OR IMPLIED WARRANTIES AND CONDITIONS RELATED TO SALE, USE OF PRODUCT, OR INFORMATION, INCLUDING WARRANTIES OR CONDITIONS OF MERCHANTABILITY, FITNESS FOR A PARTICULAR PURPOSE, ACCURACY OF INFORMATION, OR NONINFRINGEMENT.**
- Do not use or otherwise make available Product or related software or technology for any military purposes, including without limitation, for the design, development, use, stockpiling or manufacturing of nuclear, chemical, or biological weapons or missile technology products (mass destruction weapons). Product and related software and technology may be controlled under the applicable export laws and regulations including, without limitation, the Japanese Foreign Exchange and Foreign Trade Law and the U.S. Export Administration Regulations. Export and re-export of Product or related software or technology are strictly prohibited except in compliance with all applicable export laws and regulations.
- Please contact your TOSHIBA sales representative for details as to environmental matters such as the RoHS compatibility of Product. Please use Product in compliance with all applicable laws and regulations that regulate the inclusion or use of controlled substances, including without limitation, the EU RoHS Directive. **TOSHIBA ASSUMES NO LIABILITY FOR DAMAGES OR LOSSES OCCURRING AS A RESULT OF NONCOMPLIANCE WITH APPLICABLE LAWS AND REGULATIONS.**