

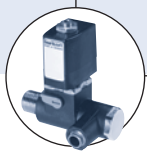

Type 2000 can be combined with...



Type 6012/6014 P

Pilot valve



Type 1062

Electrical position feedback

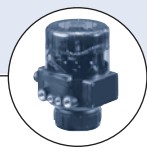

Type 8631

TopControl On/Off

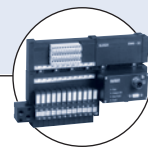

Type 8640/8644

Valve block

- High flow rate and long life cycle
- Very high cycle life
- NC and NO universal actuators with modular universal accessory program up to control heads
- Deliverable with flow direction below or above seat
- Simple conversion of the control function

The externally piloted angle-seat valve is operated with a single or double-acting piston actuator. The actuator is available in two different materials, PA and PPS depending on the ambient temperature. The reliable self-adjusting packing gland provides high sealing integrity. High flow rates are attained with the gunmetal or cast stainless steel 2-way body.

These maintenance-free and robust valves can be retrofitted with a comprehensive range of accessories for position indication, stroke limitation or manual override.

For valves with port connection Tri-Clamp® and weld end please see separate datasheets.

1) **Note:** For PA actuators in the sizes 40, 50 and 63, the combination of max. media temperature and max. ambient temperature is as shown in the following chart

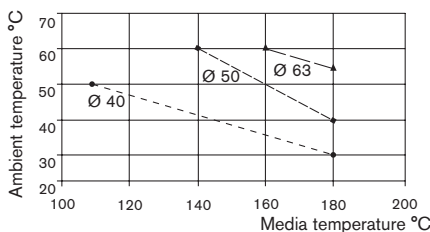

Technical data	
Orifice	DN 13 to 65
Body materials	Gunmetal, cast stainless steel 316L
Actuator material	PA or PPS
Seal material	PTFE (NBR, FKM, EPDM on request)
Medien	Water, alcohol, oils, fuel, hydraulic fluids, salt solution, alkali solutions, organic solvents, steam
Viscosity	max. 600 mm ² /s
Packing gland (with silicone grease)	PTFE V-rings with spring compensation
Media temperature¹⁾	-10 to +180 °C with PTFE seal
Ambient temperature	
PA actuator ¹⁾	-10 to +60 °C
PPS actuator ¹⁾ Ø 40-80	+5 to +140 °C
PPS actuator ¹⁾ Ø 100-125	+5 to +90 °C, briefly up to +140 °C
Installation	As required, preferably with actuator in upright position
Control medium	Neutral gases, air
Max. pilot pressure	
Actuator size Ø 40-80	PA and PPS 10 bar
Actuator size Ø 100	PA 10 bar
Actuator size Ø 100	PPS 7 bar
Actuator size Ø 125	PA and PPS 7 bar
Port connection	G 3/8 to G 2 1/2 (NPT on request)

Ordering information for Angle Seat Valve System Type 8801-YA/8803-YA

A complete continuous angle seat valve system Type 8801-YA/8803-YA consists of an angle seat control valve Type 2000 and a valve actuation system TopControl Type 8631 or an electrical position feedback Type 1062. The control head is only delivered in combination with an actuator as a part of a complete control valve. The following information is necessary for the selection of a complete control valve:

• **Item no.** of the seat control valve **Type 2000** (see Ordering chart)

• **Item no.** of the desired positioner **Type 8631 or Type 1062** (see separate datasheets)

Please also use the "request for quotation" form on p. 10 for ordering the complete system [go to page](#)

Example for variations of continuous angle seat valve system

Angle seat valve Type 2000 with required process connection



Control Head



8631



1062

Angle seat valve with required body and port connection

For port connections weld end and Tri-Clamp®, see separate datasheets



**Angle seat valve
TopControl system**
2000+8631
(Type 8801-YA)



**Angle seat valve
Electrical Position
Feedback system**
2000+1062
(Type 8803-YA)

When you click on the orange box "More info." below, you will come to our website for the resp. product where you can download the datasheet.

Control Head Type 8631 TopControl On/Off



DeviceNet™

More info.

The Type 8631 TopControl On/Off head performs the task of completely automating pneumatically operated process valves. Mechanical mounting and pneumatic coupling to the process valve result in a unit that is both visually pleasing and functionally compact. Valve position feedback and pneumatic actuation can also be integrated into common fieldbusses such as AS-Interface or DeviceNet.

Main customer benefits are:

- Control of process valves
 - single-acting/double-acting
 - with external pneumatic control
- Position feedback with maximum two adjustable inductive limit switches or two micro limit switches
- Electrical control of the control head, optionally via multipole (parallel wiring) or field bus interface (AS-Interface or DeviceNet)
- Pressure-relief valve
- Suitable for hazardous locations per zone 1 or zone 2 and 22

Electrical Position Feedback Type 1062



More info.

Positions are electrically signaled according to switch type:

- open,
 - closed or
 - open and closed.
- LEDs provide optical position indication (except for Namur Ex-version). Mechanical or inductive switches are housed in a compact splash-proof enclosure. The position indicator can be rotated 360° and is easily fitted to the valve. Trip cams do not require adjustment.
- The unit only needs to be screwed on and connected to be ready for operation.

Materials

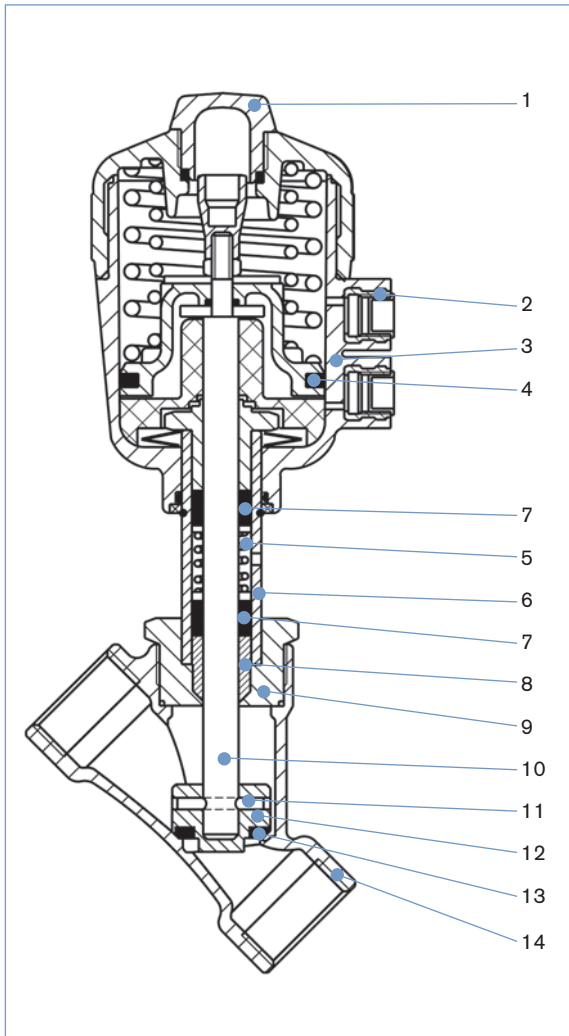

	Gunmetal body	Cast stainless steel body
1 Transparent cap	PC (with PPS actuator; PSU)	PC (with PPS actuator; PSU)
2 Pilot air ports	Brass	Stainless steel 1.4305
3 Actuator	PA, PPS	PA, PPS
4 Piston seal	NBR (with PPS actuator; FKM)	NBR (with PPS actuator; FKM)
5 Spring	Stainless steel 1.4310	Stainless steel 1.4310
6 Tube	Brass CuZn39Pb3	Stainless steel 1.4401
7 V-Seals	PTFE (FKM on request)	PTFE (FKM on request)
8 Wiper	PTFE	PTFE
9 Nipple	Brass CuZn	Stainless steel 1.4401
10 Spindle	Stainless steel 1.4021	Stainless steel 1.4401
11 Pins	Stainless steel 1.4401	Stainless steel 1.4401
12 Swivel plate	Brass CuZn36Pb1.5	Stainless steel 1.4401
13 Seal	PTFE (NBR, FKM, EPDM on request)	PTFE (NBR, FKM, EPDM on request)
14 Valve body	Gunmetal GCuSn5ZnPb2%Ni	Stainless steel 316L

Technical data for valves with flow direction below seat (for gas and liquid)

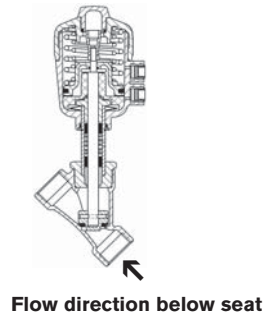

Orifice [mm]	Actuator size [mm]	Kv value water (m ³ /h)	Min. pilot pressure CFA [bar]	Max. operating pressure up to ±180°		Weight [kg]
				CFA [bar]	CFB [bar]	
13	40	3.7	4.0	15	16	0.7
	50	4.2	3.9	16	16	0.8
20	40	7.9	4.0	6.5	16	0.9
	50	8.0	3.9	11	16	1.0
	63	10	4.2	16	–	1.4
25	50	14.5	–	–	16	1.2
	63	19	4.2	11	16	1.8
	80	20	5.0	16	16	2.2
32	63	27	4.2	6	16	2.3
	80	28	5.0	15	16	3.1
40	63	35	–	–	16	2.7
	80	38	5.0	10	16	3.5
	100	42	4.4	12.5	–	5.6
	125	42	3.2	16	–	9.0
50	63	49	–	–	13	4.0
	80	52	–	–	15	4.8
	100	55	4.4	7.2	–	7.0
	125	55	3.2	10	–	9.4
65	80	77	–	–	16	6.4
	125	90	3.2	5.2	–	11.0

Kv value water [m³/h]: Measured at +20 °C, 1 bar pressure at valve inlet and free outlet
 Pressure values [bar]: Measured as overpressure to the atmospheric pressure

Pilot pressure diagram with control function B and flow direction below seat

Diagram 1

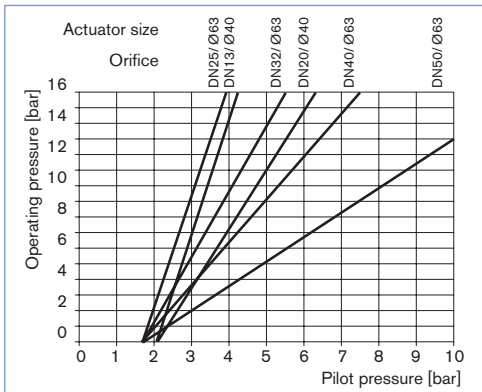
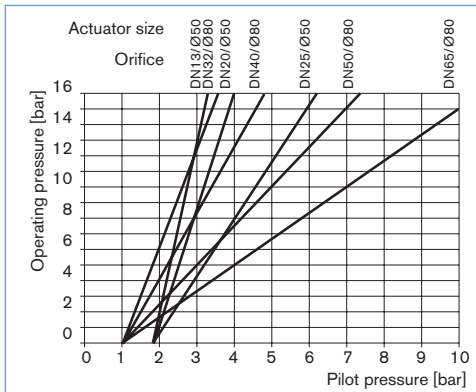

Diagram 2



Ordering chart for valves with flow direction below the seat (other versions on request)

Different actuator and body materials, standard or short valve body

Control function	Port connection	Orifice [mm]	Actuator size Ø [mm]	Kv value water [m³/h]	Minimum pilot pressure [bar]	Max. operating pressure up to 180 °C [bar]	Gunmetal body		Cast st. st. body	
							Item no. PA actuator	Item no. PPS actuator	Item no. PA actuator	Item no. PPS actuator
Standard body										
A 2/2-way, normally closed (NC) 	G 3/8	13	40	3.7	4.0	15	–	–	142 613	–
	G 1/2		40	3.7	4.0	15	002 198	–	002 196	–
	G 1/2		50	4.2	3.9	16	001 130	002 165	001 135	001 234
	G 3/4	20	40	7.9	4.0	6.5	002 199	–	002 197	–
			50	8.0	3.9	11	001 131	001 852	001 136	001 698
			63	10.0	4.2	16	002 185	–	130 175	140 767
	G 1	25	63	19.0	4.2	11	007 225	002 166	001 446	001 236
			80	20.0	5.0	16	001 983	–	130 176	–
	G 1 1/4	32	63	27.0	4.2	6.0	130 339	–	130 177	–
			80	28.0	5.0	15	001 132	002 167	001 138	001 237
	G 1 1/2	40	80	38.0	5.0	10	001 133	002 168	001 139	001 238
			125	42.0	3.2	16	130 459	–	130 460	–
	G 2	50	100	55.0	4.4	7.2	001 134	002 170	001 140	001 239
			125	55.0	3.2	10	001 593	002 171	001 601	–
G 2 1/2	65	125	90.0	3.2	5.2	001 368	–	001 373	001 703	
B 2/2-way, normally open (NO) 	G 3/8	13	40	3.7	see diagram 1 and 2 on previous page	16	140 368	–	142 616	–
	G 1/2		40	3.7	16	130 326	–	130 178	–	
			50	4.2	16	001 144	002 173	001 150	001 704	
	G 3/4	20	40	7.9	16	130 327	–	130 179	–	
			50	8.0	16	001 145	002 174	001 151	001 705	
	G 1	25	50	14.5	16	130 328	–	130 180	–	
			63	19.0	16	001 146	–	001 152	001 706	
	G 1 1/4	32	63	27.0	16	001 369	002 176	001 374	001 707	
	G 1 1/2	40	63	35.0	16	001 370	002 177	001 375	001 708	
	G 2	50	63	49.0	13	001 371	002 179	001 376	001 709	
	G 2 1/2	65	80	77.0	16	001 372	002 181	001 377	001 710	
Short valve body										
A 2/2-way, normally closed (NC) 	G 3/8	13	40	3.8	4.0	15	178 614	178 613	142 613	178 612
	G 1/2		40	3.8	4.0	15	178 608	178 607	178 606	178 605
			50	4.2	3.9	16	178 684	178 683	178 682	178 681
	G 3/4	20	50	8.5	3.9	11	178 680	178 679	178 678	178 677
			63	9.0	4.2	16	178 666	178 665	178 664	178 663
	G 1	25	63	18	4.2	11	178 676	178 675	178 674	178 667
	G 1 1/4	32	80	27	5.0	15	178 699	178 698	178 697	178 696
G 1 1/2	40	80	38	5.0	9	178 695	178 694	178 693	178 692	
B 2/2-way, normally open (NO) 	G 3/8	13	40	3.8	see diagram 1 and 2 on previous page	16	140 368	178 610	142 616	178 609
	G 1/2		40	3.8	16	178 601	178 602	178 603	178 604	
			50	4.2	16	178 691	178 690	178 689	178 688	
	G 3/4	20	50	8.5	16	178 687	179 020	178 686	178 685	
	G 1	25	50	10	16	178 850	178 849	178 848	178 847	
	G 1 1/4	32	63	25	16	178 845	178 853	178 852	178 851	
	G 1 1/2	40	63	35	16	178 864	178 863	178 862	178 861	

DTS 1000100997 EN Version: B Status: RL (released | freigegeben | validé) printed: 24.01.2008

i Further versions on request

Material
Seal: NBR, FKM, EPDM

Control function
Double-acting actuator

Port connections
Tri-Clamp®, weld end

Approvals
GL, SIL

Technical Data for valves with flow direction above seat (only for gas and steam)

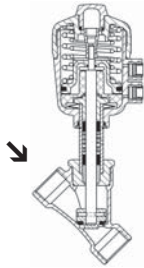

Flow direction above seat

Attention!

Valves with flow direction above the seat are only conditionally usable for liquid media. There is a danger of waterhammer!

Orifice [mm]	Actuator size [mm]	Kv value water (m ³ /h)	Max. operating pressure up to 180° C	Weight [kg]
13	40	3.7	16	0.7
	50	4.2		0.8
20	40	7.9	16	0.9
	50	8.0		1.0
25	50	14.5	16	1.2
	63	19.0		1.8
32	63	27.0	16	2.2
40	63	35.0	16	2.7
	80	38.0		3.5
50	63	49.0	16	4.0
	80	52.0		4.8
65	80	77.0	14	6.4
	100	92.0		8.6

Kv value water [m³/h]: Measured at +20 °C, 1 bar pressure at valve inlet and free outlet
 Pressure values [bar]: Measured as overpressure to the atmospheric pressure

Technical data	Flow direction above seat (only for gases and steam)
Media	Gaseous media and steam
Further technical data	Please see information Technical data on page 1

Pilot pressure diagram with control function A and flow direction above seat

Diagram 3

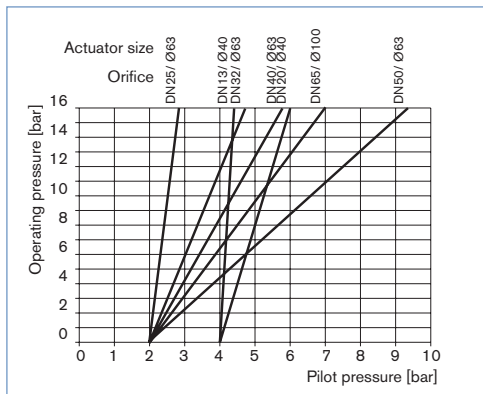
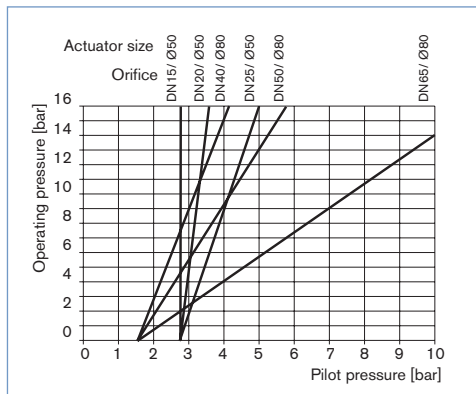

Diagram 4



Ordering chart for valves with flow direction above the seat (other versions on request)

Various actuator and body materials, standard or short valve body

Minimum pilot pressure depending on operating pressure, please see Charts 3 and 4 on previous page

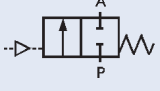
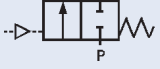
Control function	Port connection	Orifice [mm]	Actuator size Ø [mm]	Kv value water [m ³ /h]	Max. operating pressure to 180°C [bar]	Gunmetal body		Stainless steel body	
						Item no. PA actuator	Item no. PPS actuator	Item no. PA actuator	Item no. PPS actuator
Standard body									
A 2/2-way, normally closed (NC) 	G 1 1/4	32	63	27.0	16	001 249	002 146	001 399	–
	G 1 1/2	40	63	35.0	16	001 250	002 147	001 400	002 156
	G 2	50	63	49.0	16	001 251	002 149	001 401	–
	G 2 1/2	65	80	77.0	14	001 398	002 151	001 402	–
			100	90.0	16	130 332	–	130 333	–
Short valve body									
A 2/2-way, normally closed (NC) 	G 1	25	63	18.0	6	178 860	178 859	178 857	178 856
	G 1 1/4	32	63	25.0	16	178 855	178 854	178 893	178 892
	G 1 1/2	40	63	35.0	16	178 896	178 897	178 895	178 894

 Further versions on request

 **Material**
Seal: NBR, FKM, EPDM

 **Control function**
Double-acting actuator

 **Port connections**
Threaded port orifices 13-25 mm
Tri-Clamp®, weld end

 **Approvals**
GL, SIL

Ordering chart for accessories

3/2-way pilot valves with banjo bolts

Seal material valve FKM, seal material banjo bolt NBR

Valve for actuator size [Ø mm]	Type	Pressure inlet P (valve body)	Service port A (banjo bolt)	Orifice [mm]	QnN value air [l/min]	Pressure range [bar]	Electrical coil connection Ind. Std.	Power consumption [W]	Item no. Voltage/frequency [V/Hz]	
									024/DC	230/50
50-63	6012P	Tube fitting ø6 mm	G 1/4	1.2	48	0-10	Form B	4	552 283	552 286
40	6012P	G 1/4	G 1/8	1.2	48	0-10	Form B	4	552 295	552 298
50-125	6014P	G 1/4	G 1/4	2	120	0-10	Form A	8	424 103	424 107

Cable plug Type 2507, Form B or Type 2508, Form A

	Item no.
Type 2507, Form B Industrial standard, 0 to 250 V without circuitry (Type 6012 P)	423 845
Type 2508, Form A acc. DIN EN 175301-803, 0 to 250 V without circuitry (Type 6014 P, Type 0331P)	008 376

For further accessories see datasheet for Type 1062 or the accessories datasheet Type 2XXX for the full options programme.

Note: For design reasons, some of the accessories cannot be supplied for actuator size Ø 40 mm. Please request the accessories datasheet Type 2XXX.

Dimensions [mm] - standard body

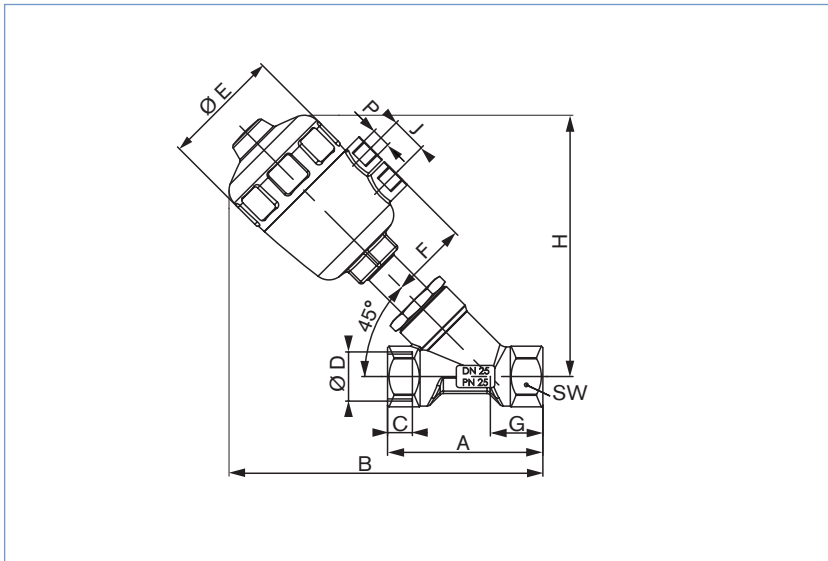

DN	Actuator size Ø	Ø E	F	P	J	B	H	A	C	ØD	G	SW
13	40	53	33	G 1/8	16.5	137	113	65	12	G 3/8	24	27
		53	33	G 1/8	16.5	146	115	85	14	G 1/2	31	27
	50	64	44	G 1/4	24	170	140					
	63	80	52	G 1/4	24	203	172					
20	40	53	33	G 1/8	16.5	155	120	95	16	G 3/4	35	32
		50	64	44	G 1/4	24	179	144				
	63	80	52	G 1/4	24	206	171					
	80	101	60	G 1/4	24	225	190					
25	40	53	33	G 1/8	16.5	160	126	105	18	G 1	35.5	41
		50	64	44	G 1/4	24	188	152				
	63	80	52	G 1/4	24	213	177					
	80	101	60	G 1/4	24	234	198					
32	63	80	52	G 1/4	24	224	183	120	20	G 1 1/4	41	50
	80	101	60	G 1/4	24	246	205					
	100	127	73	G 1/4	30	296	255					
40	63	80	52	G 1/4	24	227.3	188	130	22	G 1 1/2	40	55
		80	101	60	G 1/4	24	249	209				
	100	127	73	G 1/4	30	299.3	260					
	125	153	86	G 1/4	30	329	289					
50	63	80	52	G 1/4	24	249	204	150	24	G 2	45	70
		80	101	60	G 1/4	24	270	225				
	100	127	73	G 1/4	30	317	272					
	125	153	86	G 1/4	30	347	302					
65	63	80	52	G 1/4	30	275	218	185	26	G 2 1/2	57	85
		80	101	60	G 1/4	24	296	239				
	100	127	73	G 1/4	30	344	287					
	125	153	86	G 1/4	30	374	317					

Dimensions [mm] - short valve body

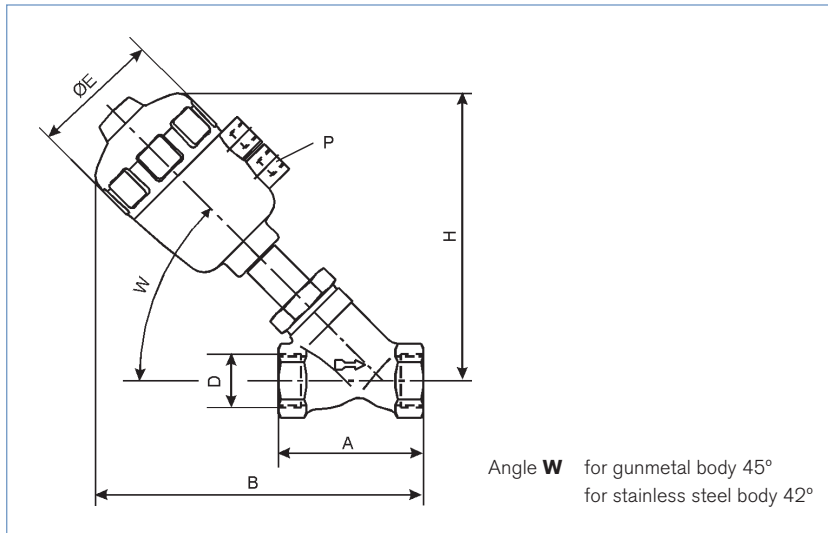

Orifice	Actuator size Ø	Port connection D	A	B	Ø E	H	P
13	40	G 3/8	65	137	53	113	G 1/8
		G 1/2	65	137	53	113	G 1/8
	50	G 3/8	65	163	64	136	G 1/4
		G 1/2	65	163	64	136	G 1/4
20	40	G 3/4	75	144	53	118	G 1/8
	50	G 3/4	75	167	64	144	G 1/4
	63	G 3/4	75	195	80	169	G 1/4
25	50	G 1	90	175	64	145	G 1/4
	63	G 1	90	199	80	170	G 1/4
	80	G 1	90	221	101	192	G 1/4
32	63	G 1 1/4	110	226	80	186	G 1/4
	80	G 1 1/4	110	255	101	210	G 1/4
40	63	G 1 1/2	120	229	80	189	G 1/4
	80	G 1 1/2	120	249	101	213	G 1/4
	100	G 1 1/2	120	300	127	260	G 1/4
	125	G 1 1/2	120	328	153	288	G 1/4
50	63	G 2	150	250	80	205	G 1/4
	80	G 2	150	270	101	225	G 1/4
	100	G 2	150	316	127	271	G 1/4
	125	G 2	150	346	153	301	G 1/4
65	80	G 2 1/2	185	296	101	239	G 1/4
	100	G 2 1/2	185	344	127	287	G 1/4
	125	G 2 1/2	185	372	153	315	G 1/4