

Sealed Subminiature Snap Action Switch D2HW







Smallest Sealed Snap-Action Switch in the Industry With a Long Stroke For Reliable ON/OFF Action

- Conforms to IP67 (lead wire type) and IP50 (terminal type)
- Case dimensions 22% smaller than conventional models
- Extra-long stroke even without levers (OT: 1.4 mm)
- All models are lead-free, including lead wire models
- RoHS Compliant







Ordering Information

■ PCB-MOUNTED MODELS









Actuator	Terminals		Contact form	Model		
				With posts on right 	With posts on left 	Without posts 
Pin plunger 	For PCB	Straight	SPDT	---	---	D2HW-A201D
		Angled		D2HW-BR201DR	D2HW-BL201DL	---
Hinge lever 		Straight		---	---	D2HW-A211D
		Angled		D2HW-BR211DR	D2HW-BL211DL	---
Long hinge lever 		Straight		---	---	D2HW-A221D
		Angled		D2HW-BR221DR	D2HW-BL221DL	---
Simulated roller lever 		Straight		---	---	D2HW-A231D
		Angled		D2HW-BR231DR	D2HW-BL231DL	---

■ MODELS WITH SOLDER TERMINALS OR LEAD WIRE TERMINALS

Actuator	Terminals		Contact form	Model		
				With posts on right 	With posts on left 	M3-screw mounting 
Pin plunger 	Solder	Downwards	SPDT	D2HW-BR201H	D2HW-BL201H	D2HW-C201H
	Lead wire		SPDT	D2HW-BR201M	D2HW-BL201M	D2HW-C201M
			SPST-NC	D2HW-BR202M	D2HW-BL202M	D2HW-C202M
			SPST-NO	D2HW-BR203M	D2HW-BL203M	D2HW-C203M





(This table continues on the next page.)

Ordering Information - continued from previous page

Actuator	Terminals		Contact form	Model			
				With posts on right 	With posts on left 	M3-screw mounting 	
Pin plunger 	Lead wire	Right-side	SPST-NC	D2HW-BR202MR	D2HW-BL202MR	D2HW-C202MR	
			SPST-NO	D2HW-BR203MR	D2HW-BL203MR	D2HW-C203MR	
		Left-side	SPST-NC	D2HW-BR202ML	D2HW-BL202ML	---	
			SPST-NO	D2HW-BR203ML	D2HW-BL203ML	---	
Hinge lever 	Solder		SPDT	D2HW-BR211H	D2HW-BL211H	D2HW-C211H	
	Lead wire	Downwards	SPDT	D2HW-BR211M	D2HW-BL211M	D2HW-C211M	
			SPST-NC	D2HW-BR212M	D2HW-BL212M	D2HW-C212M	
			SPST-NO	D2HW-BR213M	D2HW-BL213M	D2HW-C213M	
		Right-side	SPST-NC	D2HW-BR212MR	D2HW-BL212MR	D2HW-C212MR	
			SPST-NO	D2HW-BR213MR	D2HW-BL213MR	D2HW-C213MR	
		Left-side	SPST-NC	D2HW-BR212ML	D2HW-BL212ML	---	
	SPST-NO	D2HW-BR213ML	D2HW-BL213ML	---			
	Long hinge lever 	Solder		SPDT	D2HW-BR221H	D2HW-BL221H	D2HW-C221H
		Lead wire	Downwards	SPDT	D2HW-BR221M	D2HW-BL221M	D2HW-C221M
SPST-NC				D2HW-BR222M	D2HW-BL222M	D2HW-C222M	
SPST-NO				D2HW-BR223M	D2HW-BL223M	D2HW-C223M	
Right-side			SPST-NC	D2HW-BR222MR	D2HW-BL222MR	D2HW-C222MR	
			SPST-NO	D2HW-BR223MR	D2HW-BL223MR	D2HW-C223MR	
Left-side			SPST-NC	D2HW-BR222ML	D2HW-BL222ML	---	
SPST-NO		D2HW-BR223ML	D2HW-BL223ML	---			
Simulated roller lever 		Solder		SPDT	D2HW-BR231H	D2HW-BL231H	D2HW-C231H
		Lead wire	Downwards	SPDT	D2HW-BR231M	D2HW-BL231M	D2HW-C231M
	SPST-NC			D2HW-BR232M	D2HW-BL232M	D2HW-C232M	
	SPST-NO			D2HW-BR233M	D2HW-BL233M	D2HW-C233M	
	Right-side		SPST-NC	D2HW-BR232MR	D2HW-BL232MR	D2HW-C232MR	
			SPST-NO	D2HW-BR233MR	D2HW-BL233MR	D2HW-C233MR	
	Left-side		SPST-NC	D2HW-BR232ML	D2HW-BL232ML	---	
	SPST-NO	D2HW-BR233ML	D2HW-BL233ML	---			
	Leaf lever 	Solder		SPDT	D2HW-BR261H	D2HW-BL261H	D2HW-C261H
		Lead wire	Downwards	SPDT	D2HW-BR261M	D2HW-BL261M	D2HW-C261M
SPST-NC				D2HW-BR262M	D2HW-BL262M	D2HW-C262M	
SPST-NO				D2HW-BR263M	D2HW-BL263M	D2HW-C263M	
Right-side			SPST-NC	D2HW-BR262MR	D2HW-BL262MR	D2HW-C262MR	
			SPST-NO	D2HW-BR263MR	D2HW-BL263MR	D2HW-C263MR	
Left-side			SPST-NC	D2HW-BR262ML	D2HW-BL262ML	---	
SPST-NO		D2HW-BR263ML	D2HW-BL263ML	---			
Simulated leaf lever 		Solder		SPDT	D2HW-BR271H	D2HW-BL271H	D2HW-C271H
		Lead wire	Downwards	SPDT	D2HW-BR271M	D2HW-BL271M	D2HW-C271M
	SPST-NC			D2HW-BR272M	D2HW-BL272M	D2HW-C272M	
	SPST-NO			D2HW-BR273M	D2HW-BL273M	D2HW-C273M	
	Right-side		SPST-NC	D2HW-BR272MR	D2HW-BL272MR	D2HW-C272MR	
			SPST-NO	D2HW-BR273MR	D2HW-BL273MR	D2HW-C273MR	
	Left-side		SPST-NC	D2HW-BR272ML	D2HW-BL272ML	---	
	SPST-NO	D2HW-BR273ML	D2HW-BL273ML	---			

(This table continues on the next page.)

Ordering Information - continued from previous page

Actuator	Terminals		Contact form	Model		
				With posts on right 	With posts on left 	M3-screw mounting 
	Lead wire	Downwards	SPDT	D2HW-BR281M	D2HW-BL281M	D2HW-C281M
			SPST-NC	D2HW-BR282M	D2HW-BL282M	D2HW-C282M
			SPST-NO	D2HW-BR283M	D2HW-BL283M	D2HW-C283M
		Right-side	SPST-NC	---	---	D2HW-C282MR
			SPST-NO	---	---	D2HW-C283MR

Note: 1. The length of standard lead wires (AWG20) for lead wire models is 30 cm (12 in).

Note: 2. Optional post length (1.5 mm on left or right) also available. Contact your Omron representative for more information.

Specifications

CHARACTERISTICS

Item	Specification
Operating speed	1 mm to 500 mm/s (for pin plunger models)
Operating frequency	30 operations/min
Insulation resistance	100 MΩ min. (at 500 VDC)
Contact resistance (initial value)	100 mΩ max. (lead wire models: 150 mΩ max.)
Dielectric strength	600 VAC, 50/60 Hz for 1 min between terminals of the same polarity 1,500 VAC, 50/60 Hz for 1 min between current-carrying metal parts and ground, and between each terminal and non-current-carrying metal parts
Vibration resistance	Malfunction: 10 to 55 Hz, 1.5-mm double amplitude
Shock resistance	Malfunction: 300 m/s ² max.
Life expectancy	Mechanical: 1,000,000 operations min. (30 operations/min) Electrical: 100,000 operations min. (20 operations/min)
Degree of protection	IP67 for lead wire type, IP50 for terminal type
Degree of protection against electric shock	Class I
Proof tracking index (PTI)	175
Switch category	A (IEC 335)
Ambient operating temperature	-40 to 85°C (with no icing)
Ambient operating humidity	95% max. (in temperature range 5° to 35°C)
Weight	Approx. 0.7 g (for pin plunger models with terminals)

OPERATING CHARACTERISTICS

Part number	D2HW-□20□□		D2HW-□21□□		D2HW-□22□□	
	Models without posts	Models with posts and M3-mounting models	Models without posts	Models with posts and M3-mounting models	Models without posts	Models with posts and M3-mounting models
OF max.	76 gf		76 gf		50 g	
RF min.	10 gf		7 gf		3 gf	
MD max.	0.25 mm		0.5 mm		0.8 mm	
OT ref.	1.4 mm		1.6 mm		2.5 mm	
FP max.	11.2 mm	7.2 mm	12.8 mm	8.8 mm	15.5 mm	11.5 mm
OP	10.4±0.2 mm	6.4±0.2 mm	11.5±0.5 mm	7.5±0.5 mm	13.3±0.8 mm	9.3±0.8 mm
TTP max.	9.1 mm	5.1 mm	10 mm	6 mm	11 mm	7 mm

Operating Characteristics - continued from previous page

Part number	D2HW-□23□□		D2HW-□26□□	D2HW-□27□□	D2HW-□28□□
Characteristic	Models without posts	Models with posts and M3-mounting models	Models with posts and M3-mounting models	Models with posts and M3-mounting models	Models with posts and M3-mounting models
OF max.	66 gf		183 gf	183 gf	92 gf
RF min.	5 gf		20 gf	20 gf	5 gf
MD max.	0.5 mm		0.2 mm	0.5 mm	0.7 mm
OT ref.	1.9 mm		1.8 mm	2.0 mm	2.8 mm
FP max.	16.5 mm	12.5 mm	9.3 mm	12.5 mm	19 mm
OP	15.2±0.5 mm	11.2±0.5 mm	7.4±0.5 mm	10.8±0.5 mm	15.4±1.5 mm
TTP max.	13.5 mm	9.5 mm	5.8 mm	8.9 mm	12.8 mm

■ RATINGS

Rated voltage (V)	Resistive load
12 VDC	2 A
24 VDC	1 A
42 VDC	0.5 A
Minimum applicable load (see note)	
	1 mA at 5 VDC

Note: Minimum applicable loads are indicated by N standard reference values. This value represents the failure rate at a 60% (λ_{60}) reliability level (JIS C5003). The equation $\lambda_{60}=0.5 \times 10^{-6}/\text{operations}$ indicates that a failure rate of 1/2,000,000 operations can be expected at a reliability level of 60%.

■ CONTACT FORM

SPDT Contacts

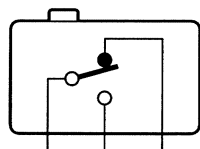

COM NO NC
(Black) (Blue) (Red)

SPST-NC Contacts
(Lead Wire Models)

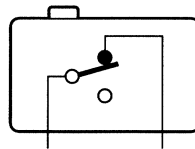

COM NC
(Black) (Red)

SPST-NO Contacts
(Lead Wire Models)

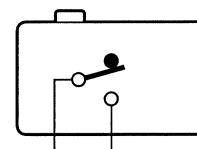

COM NO
(Black) (Blue)

Note: Lead wire colors are indicated in parentheses.

Dimensions

Unit: mm (inch)

■ PIN PLUNGER

D2HW-□20□□

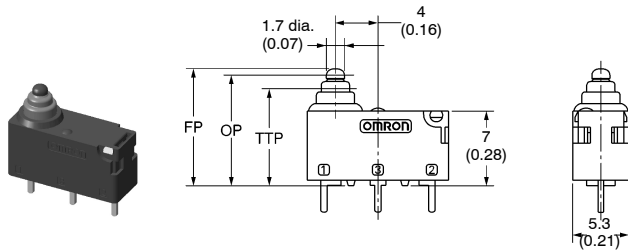

■ HINGE LEVER

D2HW-□21□□

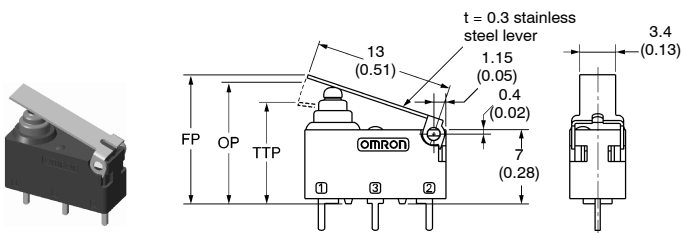

■ LONG HINGE LEVER

D2HW-□22□□

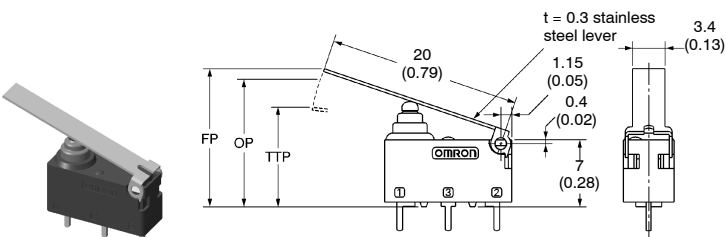

■ SIMULATED ROLLER LEVER

D2HW-□23□□

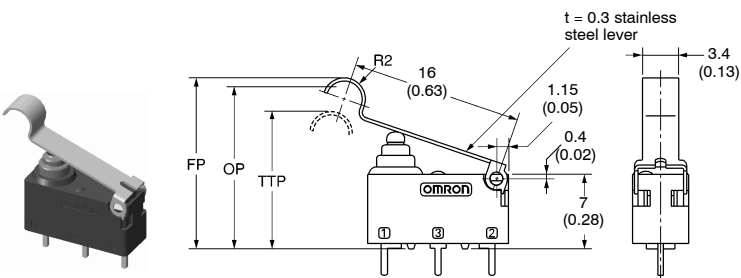

Unit: mm (inch)

■ LEAF LEVER

D2HW-□26□□

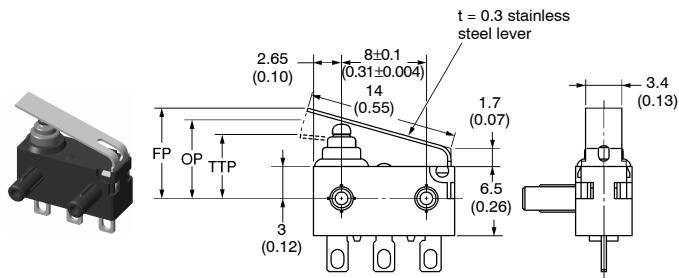

■ SIMULATED LEAF LEVER

D2HW-□27□□

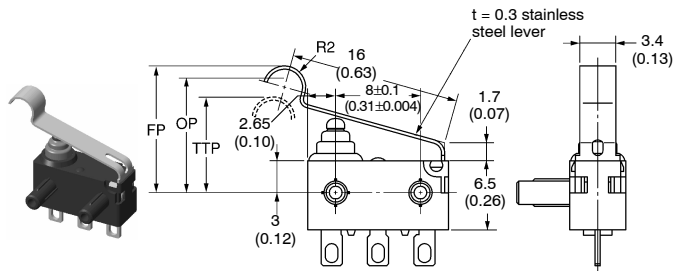

■ LONG LEAF LEVER

D2HW-□28□□

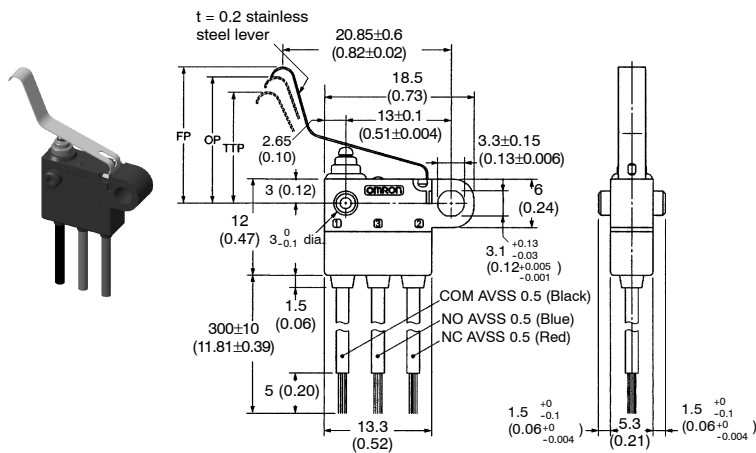

Note: Dimensions not indicated in the above diagrams have a tolerance of ± 0.2 mm.

■ MOUNTING STRUCTURE AND REFERENCE POSITIONS

The reference positions used for FP, OP, and TTP values are as shown below for each type of mounting.

D2HW-A □ Models without Posts

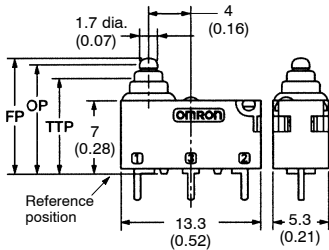

D2HW-B □ Models with Posts

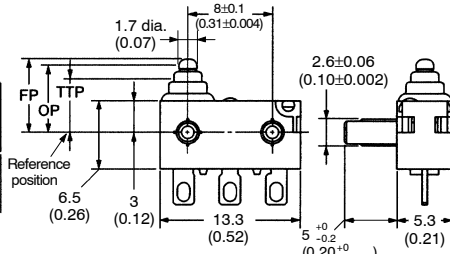

D2HW-C □ M3-screw Mounting Models

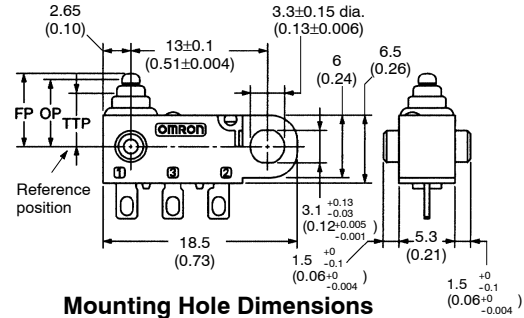

Mounting Hole Dimensions (Reference)

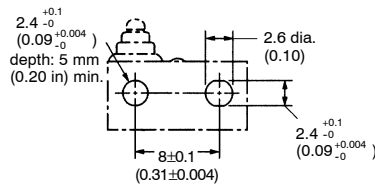

Mounting Hole Dimensions (Reference)

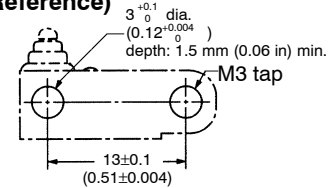

■ TERMINALS

Straight PCB Terminals

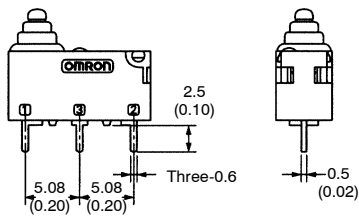

Angled PCB Terminals

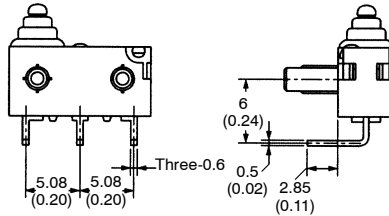

Solder Terminals

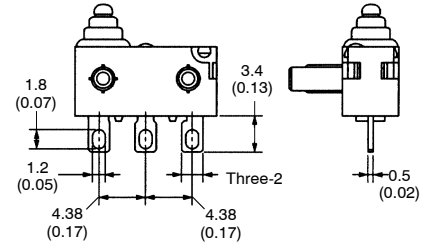

PCB Cutout Dimensions (Reference)

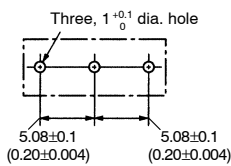

PCB Cutout Dimensions (Reference)

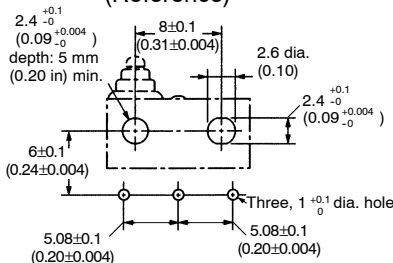

Lead Wires Downwards

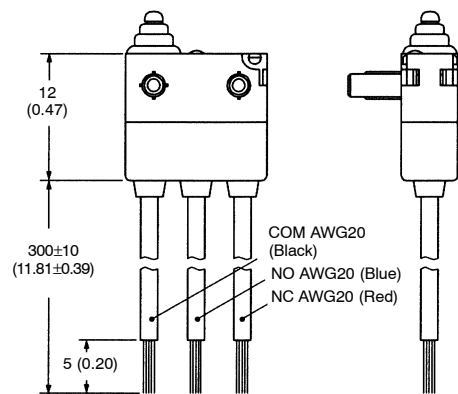

Lead Wires on Left-side

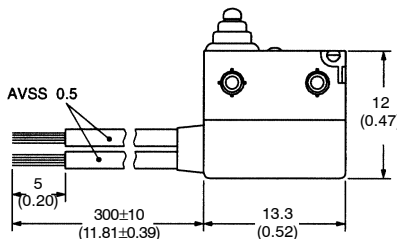

Lead Wires on Right-side

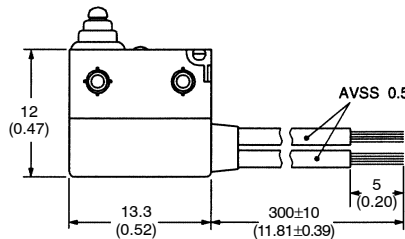

Precautions

■ CAUTIONS

Degree of Protection

Do not use this product in water. Although lead wire models satisfy the test conditions for the standard given below, this test is to check the ingress of water into the switch enclosure after submerging the Switch in water for a given time. Satisfying this test condition does not mean that the Switch can be used in water.

Lead wire models satisfy IEC Publication 529, degree of protection IP67. Refer to the following illustration for the test method.

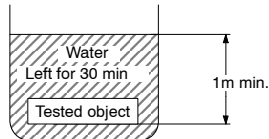

Protection Against Chemicals

Prevent the switch from coming into contact with oil and chemicals. Otherwise, damage to or deterioration of switch materials may result.

Terminal Connection

To solder the lead wire to the terminal, first entwine the conducting part around the terminal hole. Solder using a soldering iron rated at 30 W max. within 3 s.

Applying a soldering iron for too long a time or using one that is rated at more than 30 W may degrade the Switch characteristics.

When soldering PCB terminals to the PCB, ensure that the surface area of the flux or the solder does not exceed that of the PCB.

Side-actuated (cam) Operation

When using a cam to operate the switch, factors such as the operating speed, operating frequency, push-button indentation, and material and shape of the cam will affect the durability of the switch. Confirm performance specifications under actual operation conditions before using the switch in applications.

■ CORRECT USE

Mounting

Always turn OFF the power supply before mounting or dismounting, wiring, or performing maintenance inspections. Failure to do so may result in electric shock or burning.

Mount M3-screw mounted models securely, using M3 mounting screws with plain or spring washers. Tighten the screws to a torque of 0.29 N·m max. Tightening the screws to a torque exceeding this may result in deterioration of the sealing or damage to the product.

For models with posts, secure the posts by thermal caulking or by pressing into an attached device. When pressed into an attached device, provide guides on the opposite ends of the posts to ensure that they do not fall out or rattle.

Mount the Switch onto a flat surface. Mounting on an uneven surface may cause deformation of the Switch, resulting in faulty operation or damage.

Operating Body

Use an operating body with low frictional resistance and of a shape that will not interfere with the sealing rubber, otherwise the plunger may be damaged or the sealing may deteriorate.

Handling

Do not handle the Switch in a way that may cause damage to the sealing rubber.

When handling the switch, ensure that uneven pressure or, as shown below, pressure in a direction other than the operating direction is not applied to the actuator, otherwise the actuator or switch may be damaged, or the service life may be reduced.

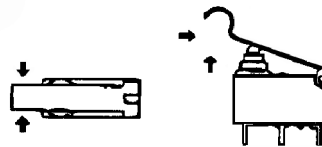

Wiring Lead Wire Models

When wiring lead wire models, ensure that there is no tension or that there are no sharp bends near the parts where the wire is drawn out. Otherwise, damage to the Switch or deterioration in the sealing may result.

Using the Switch with Micro Loads

Even when the Switch is used within the appropriate operating range, power surges may shorten its service life. Insert a contact protection circuit as required.

Terms and Conditions of Sale

1. Offer; Acceptance. These terms and conditions (these "Terms") are deemed part of all quotations, acknowledgments, invoices, purchase orders and other documents, whether electronic or in writing, relating to the sale of products or services (collectively, the "Products") by Omron Electronic Components LLC ("Seller"). Seller hereby objects to any terms or conditions proposed in Buyer's purchase order or other documents which are inconsistent with, or in addition to, these Terms.
2. Prices; Payment. All prices stated are current, subject to change without notice by Seller. Buyer agrees to pay the price in effect at time of shipment. Payments for Products received are due net 30 days unless otherwise stated in the invoice.
3. Discounts. Cash discounts, if any, will apply only on the net amount of invoices sent to Buyer after deducting transportation charges, taxes and duties, and will be allowed only if (i) the invoice is paid according to Seller's payment terms and (ii) Buyer has no past due amounts owing to Seller.
4. Currencies. If the prices quoted herein are in a currency other than U.S. dollars, Buyer shall make remittance to Seller at the then current exchange rate most favorable to Seller and which is available on the due date; provided that if remittance is not made when due, Buyer will convert the amount to U.S. dollars at the then current exchange rate most favorable to Seller available during the period between the due date and the date remittance is actually made.
5. Governmental Approvals. Buyer shall be responsible for, and shall bear all costs involved in, obtaining any government approvals required for the importation or sale of the Products.
6. Taxes. All taxes, duties and other governmental charges (other than general real property and income taxes), including any interest or penalties thereon, imposed directly or indirectly on Seller or required to be collected directly or indirectly by Seller for the manufacture, production, sale, delivery, importation, consumption or use of the Products sold hereunder (including customs duties and sales, excise, use, turnover and license taxes) shall be charged to and remitted by Buyer to Seller.
7. Financial. If the financial position of Buyer at any time becomes unsatisfactory to Seller, Seller reserves the right to stop shipments or require satisfactory security or payment in advance. If Buyer fails to make payment or otherwise comply with these Terms or any related agreement, Seller may (without liability and in addition to other remedies) cancel any unshipped portion of Products sold hereunder and stop any Products in transit until Buyer pays all amounts, including amounts payable hereunder, whether or not then due, which are owing to it by Buyer. Buyer shall in any event remain liable for all unpaid accounts.
8. Cancellation; Etc. Orders are not subject to rescheduling or cancellation unless Buyer indemnifies Seller fully against all costs or expenses arising in connection therewith.
9. Force Majeure. Seller shall not be liable for any delay or failure in delivery resulting from causes beyond its control, including earthquakes, fires, floods, strikes or other labor disputes, shortage of labor or materials, accidents to machinery, acts of sabotage, riots, delay in or lack of transportation or the requirements of any government authority.
10. Shipping; Delivery. Unless otherwise expressly agreed in writing by Seller:
 1. Shipments shall be by a carrier selected by Seller;
 2. Such carrier shall act as the agent of Buyer and delivery to such carrier shall constitute delivery to Buyer;
 3. All sales and shipments of Products shall be FOB shipping point (unless otherwise stated in writing by Seller), at which point title to and all risk of loss of the Products shall pass from Seller to Buyer, provided that Seller shall retain a security interest in the Products until the full purchase price is paid by Buyer;
 4. Delivery and shipping dates are estimates only.
 5. Seller will package Products as it deems proper for protection against normal handling and extra charges apply to special conditions.
11. Claims. Any claim by Buyer against Seller for shortage or damage to the Products occurring before delivery to the carrier must be presented in writing to Seller within 30 days of receipt of shipment and include the original transportation bill signed by the carrier noting that the carrier received the Products from Seller in the condition claimed.
12. Warranties. (a) Exclusive Warranty. Seller's exclusive warranty is that the Products will be free from defects in materials and workmanship for a period of twelve months from the date of sale by Seller (or such other period expressed in writing by Seller). Seller disclaims all other warranties, express or implied. (b) Limitations. SELLER MAKES NO WARRANTY OR REPRESENTATION, EXPRESS OR IMPLIED, ABOUT NON-INFRINGEMENT, MERCHANTABILITY OR FITNESS FOR A PARTICULAR PURPOSE OF THE PRODUCTS. BUYER ACKNOWLEDGES THAT IT ALONE HAS DETERMINED THAT THE PRODUCTS WILL SUITABLY MEET THE REQUIREMENTS OF THEIR INTENDED USE. Seller further disclaims all warranties and responsibility of any type for claims or expenses based on infringement by the Products or otherwise of any intellectual property right. (c) Buyer Remedy. Seller's sole obligation hereunder shall be to replace (in the form originally shipped with Buyer responsible for labor charges for removal or replacement thereof) the non-complying Product or, at Seller's election, to repay or credit Buyer an amount equal to the purchase price of the Product; provided that in no event shall Seller be responsible for warranty, repair, indemnity or any other claims or expenses regarding the Products unless Seller's analysis confirms that the Products were properly handled, stored, installed and maintained and not subject to contamination, abuse, misuse or inappropriate modification. Return of any Products by Buyer must be approved in writing by Seller before shipment. Seller shall not be liable for the suitability or unsuitability or the results from the use of Products in combination with any electrical or electronic components, circuits, system assemblies, or any other materials or substances or environments. Any advice, recommendations or information given orally or in writing are not to be construed as an amendment to the above warranty.
13. Limitation on Liability; Etc. SELLER SHALL NOT BE LIABLE FOR SPECIAL, INDIRECT, INCIDENTAL OR CONSEQUENTIAL DAMAGES, LOSS OF PROFITS OR PRODUCTION OR COMMERCIAL LOSS IN ANY WAY CONNECTED WITH THE PRODUCTS, WHETHER SUCH CLAIM IS BASED IN CONTRACT, WARRANTY, NEGLIGENCE OR STRICT LIABILITY. Further, in no event shall liability of Seller exceed the individual price of the Product on which liability is asserted.
14. Indemnities. Buyer shall indemnify and hold harmless Seller, its affiliates and its employees from and against all liabilities, losses, claims, costs and expenses (including attorney's fees and expenses) related to any claim, investigation, litigation or proceeding (whether or not Seller is a party) which arises or is alleged to arise from Buyer's acts or omissions under these Terms or in any way with respect to the Products. Without limiting the foregoing, Buyer (at its own expense) shall indemnify and hold harmless Seller and defend or settle any action brought against Seller to the extent that it is based on a claim that any Product made to Buyer specifications infringed intellectual property rights of another party.
15. Property; Confidentiality. The intellectual property embodied in the Products is the exclusive property of Seller and its affiliates and Buyer shall not attempt to duplicate it in any way without the written permission of Seller. Notwithstanding any charges to Buyer for engineering or tooling, all engineering and tooling supplied by Seller to Buyer relating to the Products are confidential and proprietary, and Buyer shall limit distribution thereof to its trusted employees and strictly prevent disclosure to any third party.
16. Miscellaneous. (a) Waiver. No failure or delay by Seller in exercising any right and no course of dealing between Buyer and Seller shall operate as a waiver of rights by Seller. (b) Assignment. Buyer may not assign its rights hereunder without Seller's written consent. (c) Law. These Terms are governed by Illinois law (without regard to conflict of law principles). Federal and state courts in Illinois shall have exclusive jurisdiction for any dispute hereunder. (d) Amendment. These Terms constitute the entire agreement between Buyer and Seller relating to the Products, and no provision may be changed or waived unless in writing signed by the parties. (e) Severability. If any provision hereof is rendered ineffective or invalid, such provision shall not invalidate any other provision. (f) Setoff. Buyer shall have no right to set off any amounts against the amount owing in respect of this invoice. (g) Definitions. As used herein, "including" means "including without limitation".

Certain Precautions on Specifications and Use

1. **Suitability for Use.** Seller shall not be responsible for conformity with any standards, codes or regulations which apply to the combination of the Product in Buyer's application or use of the Product. At Buyer's request, Seller will provide applicable third party certification documents identifying ratings and limitations of use which apply to the Product. This information by itself is not sufficient for a complete determination of the suitability of the Product in combination with the end product, machine, system, or other application or use. Buyer shall be solely responsible for determining appropriateness of the particular Product with respect to Buyer's application, product or system. Buyer shall take application responsibility in all cases but the following is a non-exhaustive list of applications for which particular attention must be given:
 - (i) Outdoor use, uses involving potential chemical contamination or electrical interference, or conditions or uses not described in this document.
 - (ii) Energy control systems, combustion systems, railroad systems, aviation systems, medical equipment, amusement machines, vehicles, safety equipment, and installations subject to separate industry or government regulations.
 - (iii) Use in consumer products or any use in significant quantities.
 - (iv) Systems, machines and equipment that could present a risk to life or property. Please know and observe all prohibitions of use applicable to this product.

NEVER USE THE PRODUCT FOR AN APPLICATION INVOLVING SERIOUS RISK TO LIFE OR PROPERTY WITHOUT ENSURING THAT THE SYSTEM AS A WHOLE HAS BEEN DESIGNED TO ADDRESS THE RISKS, AND THAT THE OMRON PRODUCT IS PROPERLY RATED AND INSTALLED FOR THE INTENDED USE WITHIN THE OVERALL EQUIPMENT OR SYSTEM.
2. **Programmable Products.** Seller shall not be responsible for the user's programming of a programmable product, or any consequence thereof.
3. **Performance Data.** Performance data given in this publication is provided as a guide for the user in determining suitability and does not constitute a warranty. It may represent the result of Seller's test conditions, and the users must correlate it to actual application requirements. Actual performance is subject to Seller's Warranty and Limitations of Liability.
4. **Change in Specifications.** Product specifications and accessories may be changed at any time based on improvements and other reasons. It is our practice to change part numbers when published ratings or features are changed or when significant construction changes are made. However, some specifications of the Product may be changed without any notice. When in doubt, special part numbers may be assigned to fix or establish key specifications for your application. Please consult with your Seller representative at any time to confirm actual specifications of purchased Product.
5. **Errors and Omissions.** The information in this publication has been carefully checked and is believed to be accurate; however, no responsibility is assumed for clerical, typographical or proofreading errors, or omissions.
6. **RoHS Compliance.** Where indicated, our products currently comply, to the best of our knowledge as of the date of this publication, with the requirements of the European Union's Directive on the Restriction of certain Hazardous Substances ("RoHS"), although the requirements of RoHS do not take effect until July 2006. These requirements may be subject to change. Please consult our website for current information.

Complete "Terms and Conditions of Sale" for product purchase and use are on Omron's website at www.components.omron.com – under the "About Us" tab, in the Legal Matters section.

ALL DIMENSIONS SHOWN ARE IN MILLIMETERS.

To convert millimeters into inches, multiply by 0.03937. To convert grams into ounces, multiply by 0.03527.

OMRON®

**OMRON ELECTRONIC
COMPONENTS LLC**

55 E. Commerce Drive, Suite B
Schaumburg, IL 60173

847-882-2288

OMRON CANADA, INC.

885 Milner Avenue
Toronto, Ontario M1B 5V8

416-286-6465

OMRON ON-LINE

Global - <http://www.omron.com>

USA - <http://www.components.omron.com>

Canada - <http://www.omron.ca>