



ENGINEERING YOUR SUCCESS.

Parker Hannifin Corporation
Hose Products Division
30240 Lakeland Boulevard
Wickliffe, OH 44092 USA
Phone: 4409435700
Fax: 4409433129

PARKER Hose Products
Crimp Style Hydraulic Hose Fitting - 43 Series Fittings

PART Number: 1C943-16-8

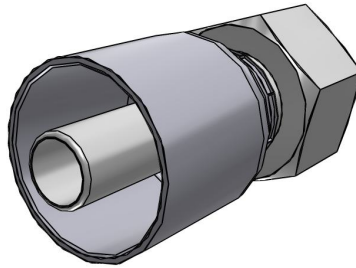

*Interactive 3D graphic, click to activate and rotate
(3D capable PDF viewer required)*

Technical Data	
Part Number	1C943-16-8
Series Name	Crimp Style Hydraulic Hose Fitting - 43 Series Fittings
Series Code	43 Series Fittings
Division ID	687583
Division Name	Hose Products Division
Company	Parker Hannifin

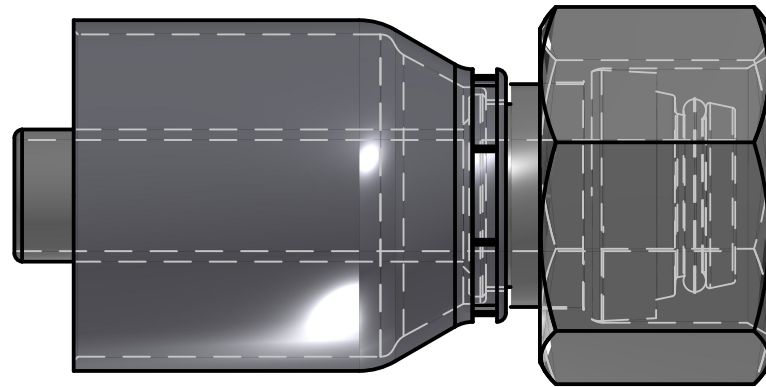
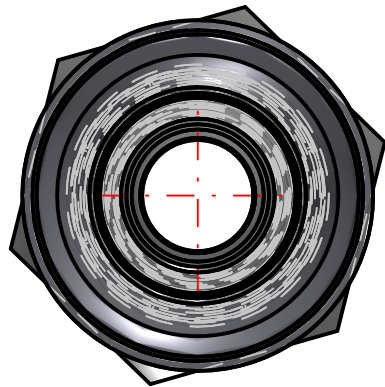
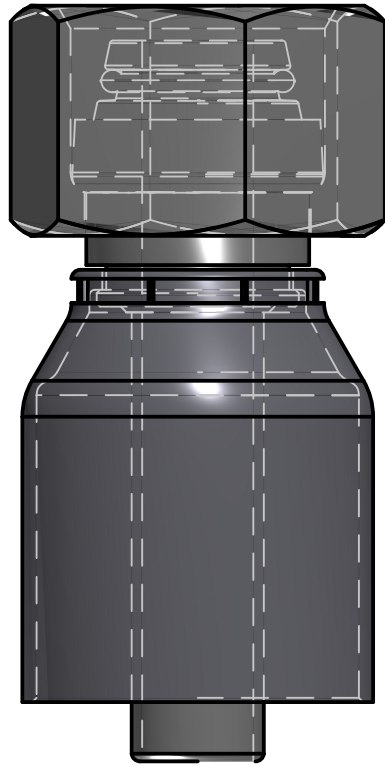

Disclaimer:

Parker Hose Products has a continuous policy of product development and although the Company reserves the right to change specifications, it attempts to keep customers informed of any alterations. This publication is for general information only and customers are requested to contact our Sales Department for detailed information and advice on a products suitability for specific applications. All products are sold subject to the company's Standard conditions of sale.

1C943-16-8



Price: contact Parker