

KEMET Part Number: HHBC13-1R2A0045V
(UALC131R2A0045)

KEMET, HHBC, AC Line Filters, Normal Mode, 45 uH, 20%

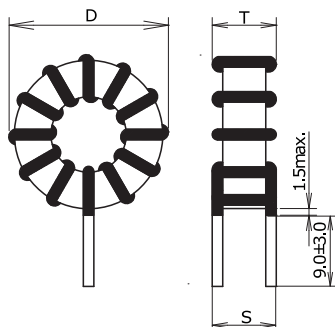

Dimensions	
D	30mm MAX
T	14.9mm MAX
LL	9mm +/-3mm
S	11mm NOM

Packaging Specifications	
Packaging:	Tray
Packaging Quantity:	150
Weight:	23 g

General Information	
Series:	HHBC
Style:	Through-Hole
Features:	Noise Solution, Switching Power Supply Outlets, DC-DC Converter
RoHS:	Yes
Miscellaneous:	25 (K) Temperature Rise Max.

Specifications	
Inductance:	45 uH
Inductance Tolerance:	20%
Current:	6 A
Temperature Range:	-40/+125°C
DC Resistance:	18.3 mOhms