



48 mm



**Matsushita**  
Programmable Controller FP-e



# FP-e Series

The universal compact PLC

Do this, do that, do everything. **All in One!**



### 3-color Display

Simple characters and numerical values can be displayed. Simple messages as well as timer/counter settings and elapsed values can also be displayed.

### Built-in operation switch

Setting values can be changed. The operation switch can also be used as an input.

### Compact

Panel mountable, little space is taken up on the control panel. The size is only 48 × 48 × 70 mm (behind faceplate).

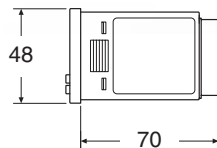

### Matches FP0 intelligence (equivalent to FP0-C14)

### Panel mounted type (in accordance with IP66, IEC standard)

To match panel design, a black faceplate is available.



## Same programming tools used as with the FP Series

### One programming software for all PLC types

Programming software and cables are common for all FP Series PLCs, so that any program created for the FP Series can be used by the FP-e as well. FPWIN Pro Ver.5 and FPWIN GR from Ver.2.3 offer a dialog to configure the screen display of the FP-e easily. You can check the result of the configuration directly with the display in the dialog.



# FP-e Series

## Optimised for a wide range of applications

### Equipped with RS485 and RS232C interfaces

- Up to 99 computer link stations are possible with RS485. (RS485 type)

Up to 32 computer link stations are possible using a C-NET adaptor and up to 99 are possible using a commercially available adaptor. You can easily monitor operation status or perform control.

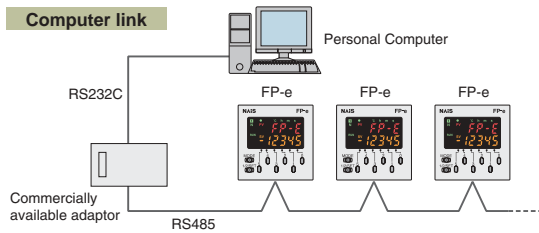

- With RS232C, communication with up to two ports is possible. (RS232C type)

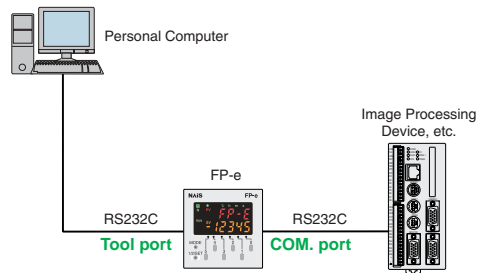

### Can even handle temperature control

- Two-point K-type thermocouple (-30 to 300°C) connection is possible. (equipped with thermocouple input)

Can be used in place of a temperature controller or used to control them.

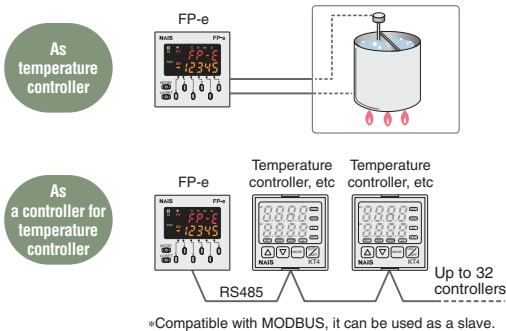

- PID instruction function

High-performance temperature control can be achieved with PID instruction.

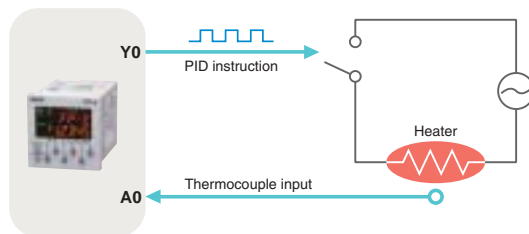

### Equipped with high-speed counter for support of 2-axis independent positioning

- Pulse output function

The unit comes equipped with 2 channels for pulse output of up to 10 kHz pulses. Since these two channels can be separately controlled, the FP-e is also suitable for 2-axis independent positioning.

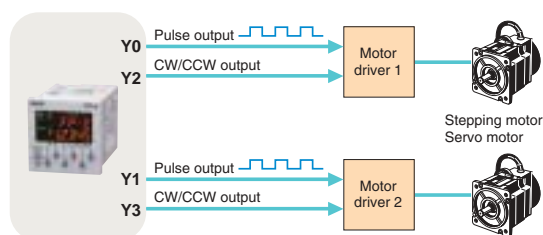

- High-speed counter function

In single phase, the 4-channel total is 10 kHz, and in 2-phase the 2-channel total is 2 kHz total speed, making the FP-e suitable for inverter control, etc.

(One half for the type with thermocouple input.)

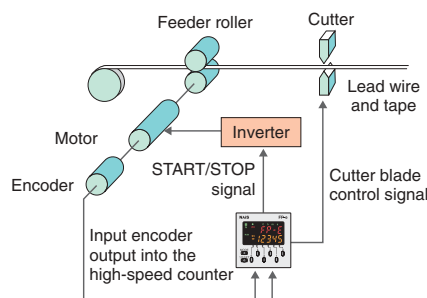



# FP-e Control Units

Decisive advantages in its class

## FP-e Control Unit

New Age, Advanced Controller!

Timer, Counter, Hour Meter, Temperature Controller and PLC in one Unit



### ■ Features

#### 1. 5-character, 2-line, 3-color Display

Simple characters and numerical values can be displayed. Simple error messages as well as operation instructions and timer/counter set values can be displayed.

#### 2. Front Operation Switch

Timer/Counter set values can be changed using front operation switches. The switches can also be used as input switches (X30 to X3F), so you need not install external switches.

#### 3. Equivalent to FP0-C14 Intelligence of Small PLCs

In addition to the functions of programmable controller FP0, pulse output and high-speed counter functions can be used. The unit comes equipped with a tool port, and COM. port (RS232C/RS485) for communication.

#### 4. Easy Programming Using Wizard

Screen display instructions can be easily created using a programming tool wizard in FPWIN GR Ver. 2.3. or FPWIN Pro Ver. 5.0.

#### 5. Smooth Debugging

Monitoring memory area data and the I/O status facilitates debugging using the R (register) and I (I/O monitor) display modes.

#### 6. Panel Mounted Type

The front of a unit is water-proof (in accordance with IP66, IEC standard).

### ■ Type

Name	Type	Calendar timer	Thermocouple input	COM. port	Product No.
FP-e control unit	Standard type (RS232C)	Not available	Not available	RS232C	AFPE224300
	Calendar timer type (RS232C)	Available	Not available	RS232C	AFPE224305
	Thermocouple input type (RS232C)	Available	Available	RS232C	AFPE214325
	Standard type (RS485)	Not available	Not available	RS485	AFPE224302
	Thermocouple input type (RS485)	Not available	Available	RS485	AFPE214322

### ■ Display modes and functions

#### 1 N mode (Normal mode)

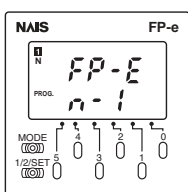

Displays characters and numerical values, numerical data can be changed.

#### 2 S mode (Switch mode)

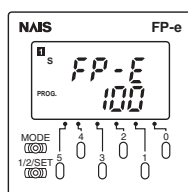

Can also display characters and numerical values. Operation switches can be used as inputs.

#### 3 R mode (Register mode)

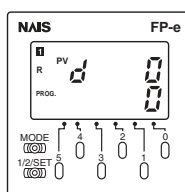

Operation memory in the controller can be monitored and its data changed.

#### 4 I mode (I/O monitor mode)

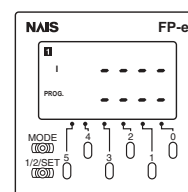

I/O status (X, Y) in the controller can be monitored.



# FP-e Series

## Specification table



### Performance specifications

Model		AFPE224300 Standard type (RS232C)	AFPE224302 Standard type (RS485)	AFPE224305 Calendar timer type (RS232C)	AFPE214325 Thermocouple input type (RS232C)	AFPE214322 Thermocouple input type (RS485)
Item		Relay symbol/Cyclic operation				
Programming method/Control method	Control unit	14 points [Input: 8, Output: 6 (Tr. NPN: 5/Ry: 1)]			12 points [Input: 6, Output: 6 (Tr. NPN: 5/Ry: 1)]	
	Front switch input	8 points				
Number of controllable I/O points	Built-in memory	Built-in EEPROM				
Program memory		2,720 steps				
Program capacity	Basic	83				
	High-level	117				
Operation speed		0.9 μs/step (Basic instruction)				
I/O update and Base time		Typical 2 ms				
Operation memory points	Relays	Internal relay (R)				
		Special internal relay (R)				
		Timer/Counter (T/C)				
	Memory areas	144 points (Initial setting: 100 timer points, T0 to T99/44 counter points, C100 to C143 <sup>Note 1)</sup> Timer range (1 ms, 10 ms, 100 ms, 1 s): selected by instruction				
Data register (DT)						
Special data register (DT)						
		Index registers (IX, IY)				
Differential points		Unlimited number of points				
Master control relay points (MCR)		32 points				
Number of labels (JP and LOOP)		64 labels				
Number of step ladders		128 stages				
Number of subroutines		16 subroutines				
Number of interrupt programs		7 programs (external: 6, internal 1)				
Self-diagnostic function		Watchdog timer, program syntax check, etc.				
Clock/calendar function <sup>Note 2)</sup>		Not available			Available (year, month, day, hour, minute, second and day of week). However, this can only be used when a battery has been installed.	
Battery life		Not available			220 days or more (actual usage value: approx. 870 days (25°C). (Periodic replacement interval: 1 year). (Value applies when no power is supplied at all.)	
Pulse catch input		6 points in total (X0 and X1: 50 μs, X2 to X5: 100 μs)				
Interrupt input		6 points in total (X0 and X1: 50 μs, X2 to X5: 100 μs)				
COM. port <sup>Note 3)</sup>		RS232C	RS485	RS232C	RS232C	RS485
Periodical interrupt		0.5 ms to 30 s				
Constant scan		Available				
Password		Available				
Special functions	High-speed counter function	Counter mode: Addition/subtraction (1-phase) <sup>Note 4)</sup> - Input points: 4 ch. (Max.)				
		- Max. speed: 10 kHz (total of 4 ch.)		5 kHz (total of 4ch.)		
		- Input contact: X0: count input (ch. 0), X1: count input (ch. 1), X2: reset input <sup>Note 5)</sup> X3: count input (ch. 2), X4: count input (ch. 3), X5: reset input				
		- Min. input pulse width: X0 and X1: 50 μs (10 kHz)		X0 and X1: 100 μs (5 kHz)		
		X3 and X4: 100 μs (5kHz)				
	* The combinations 1-phase × 2 ch. and 2-phase × 1 ch. are also possible for the high-speed counter.	Counter mode: 2-phase/individual/direction decision (2-phase) - Input points: 2 ch (Max.)				
		- Max. speed: 2 kHz (total of 2 ch.)		1 kHz (total of 2ch.)		
		- Input contact: X0: count input (ch. 0), X1: count input (ch. 0), X2: reset input X3: count input (ch. 2), X4: count input (ch. 2), X5: reset input				
		- Min. input pulse width: X0 and X1: 50 μs (10 kHz)		X0 and X1: 100 μs (5 kHz)		
		X3 and X4: 100 μs (5 kHz)				
Pulse output function	Output points	2 independent points (Y0 and Y1) (No interpolation function)				
	Output frequency	40 Hz to 10 kHz (Y0/Y1: 1-point) <sup>Note 6)</sup> 40 Hz to 5 kHz (Y0/Y1: 2-point)			40 Hz to 5 kHz (1-point) 40 Hz to 2.5 kHz (2-point)	
PWM output function	Output points	2 points (Y0 and Y1)				
	Output frequency	Frequency: 0.15 Hz to 1 kHz Duty: 0.1 % to 99.9 %				
Timer	Non-hold type: (all points)					
	Counter	From set value to C139				
Memory backup <sup>Note 7)</sup>	Counter	4 points (elapsed values) C140 to C143				
	Internal relay	Non-hold type	976 points (R0 to R60F)		61 words (WR0 to WR60)	
Hold type		32 points (R610 to R62F)		2 words (WR61 to WR62)		
Data register	Non-hold type	1,652 words (DT0 to DT1651)				
	Hold type	8 words (DT1652 to DT1659)				

Note 1) The proportion of timer points to counter points can be changed using a system register.

Note 2) Precision of calendar timer:

- At 0°C/32°F, less than 200 seconds of error per month
- At 25°C/77°F, less than 70 seconds of error per month
- At 55°C/131°F, less than 240 seconds of error per month

Note 3) When using the COM. port for communication, retransmission is recommended.

The RS232C driver IC for the COM. port conforms completely to EIA/TIA-232E and CCITT V.28 standards

Note 4) The max. counting speed (10 kHz) is the counting speed with a rated input voltage of 24 V DC and an ambient temperature of 25°C. The counting speed (frequency) will decrease depending on the voltage and temperature.

Note 5) If the unit is equipped with both reset inputs X0 and X1, X2 serves as the reset input for X1. If X3 and X4 are used, X5 serves as the reset input for X4.

Note 6) When the positioning control instruction "F168" is performed, the maximum output frequency is 9.5 kHz.

Note 7) The program, system registers and the hold type area (internal relay, data register, and timer/counter) are backed up by the built-in EEPROM.

When a battery is replaced with a new one in the FP-e unit with a calendar timer function, settings can be changed without installing a battery. The data cannot be stored even when the settings are changed using the system register.

Note 8) F180 (SCR) and F181 (DSP) instructions are supported from Control FFWIN GR Ver. 2.2. and FFWIN Pro V 4.1.



# FP-e Series

## Technical data

### General specifications

Item	Description		
Rated voltage	24 V DC		
Operating voltage range	21.6 to 26.4 V DC		
Allowed momentary power off time	10 ms		
Ambient temperature	0 to +55°C		
Storage temperature	-20 to +70°C		
Ambient humidity	30 to 85%RH (non-condensing)		
Storage humidity	30 to 85%RH (non-condensing)		
Breakdown voltage	Input terminals (COM, X0 to Xn) Output terminals (Y0 to Y4)	Power supply terminal, Function earth Input terminal (A0, A1) COM. (RS232C) terminal	500 V AC for 1 minute
	Output terminal (Y5)	Power supply terminal, Function earth Input terminal (COM, X0 to Xn, A0, A1) COM. (RS232C) terminal	1500 V AC for 1 minute
	Input terminals (COM, X0 to Xn)	Output terminals (Y0 to Y4)	500 V AC for 1 minute
Insulation resistance	Input terminals (COM, X0 to Xn) Output terminals (Y0 to Y5)	Power supply terminal, Function earth Input terminal (A0, A1) COM. (RS232C) terminal	Min. 100 M (measured with 500 V DC)
	Input terminals (COM, X0 to Xn)	Output terminals (Y0 to Y5)	
Vibration resistance	10 to 55 Hz, 1 cycle/min. Double amplitude: 0.75 mm, 10 min. on X, Y, and Z axes		
Shock resistance	98 m/s <sup>2</sup> or more, 4 times on X, Y, and Z axes		
Noise resistance	1000V (p-p) with pulse widths 50 ns and 1 μs (based on in-house measurements)		
Operating condition	Free from corrosive gases and excessive dust		
Current consumption	200 mA or less (24 V DC)		
Protection	IP66-compliant front section (Only when a rubber packing is used.)		
Mass	Approx. 130 g		

### DC input specifications (X0 to X7)

Item	Description
Number of input	8 points (6 points for thermocouple input type)
Insulation method	Optical coupler
Rated input voltage	24 V DC
Operating voltage range	21.6 to 26.4 V DC
Rated input current	Approx. 4.3 mA
Input points per common	8 points/common (6 points/common for thermocouple input type) Either the positive or negative of the input power supply can be connected to common terminal.
ON voltage/ON current	19.2 V or less/4 mA or less
OFF voltage/OFF current	2.4 V or more/1 mA or more
Input impedance	Approx. 5.1 k (X0, X1) Approx. 5.6 k (X2 to X7)
Response time	50 μs or less (X0, X1) <sup>Note 1)</sup>
	100 μs or less (X2 to X5) <sup>Note 1)</sup>
	2 ms or less (X6, X7)
	50 μs or less (X0, X1) <sup>Note 1)</sup>
	100 μs or less (X2 to X5) <sup>Note 1)</sup>
Operating mode indicator	LCD display (I/O monitor mode)

Note 1) X0 through X5 are inputs for the high-speed counter and have a fast response time. If used as normal inputs, you should insert a timer in the program as chattering and noise may be interpreted as an input signal. Also, the above specifications apply when the rated input voltage is 24V DC and the temperature is 25°C.

### Thermocouple input specifications

Item	Description
Number of input	2 points (CH0: WX1, CH1: WX2)
Temperature sensor type	Thermocouple type K
Input range	-30.0 to 300.0°C <sup>*1)</sup> (-22 to 572°F)
Accuracy	±0.5%FS±1.5°C (FS = -30 to 300°C)
Resolution	0.1°C
Conversion time	250 ms/2CH <sup>*2)</sup>
Insulation method	Between internal circuit and thermocouple input circuit: noninsulated <sup>*3)</sup> Between CH0 and CH1 of thermocouple input: PhotoMOS insulation
Detection function of wire disconnection	Available

\*1) Temperature can be measured up to 330°C (626°F). When the measured temperature exceeds 330°C (626°F) or the thermocouple wiring is disconnected, "K20000" is written to the register.

\*2) Temperature conversion for thermocouple input is performed every 250 ms. The conversion data is updated on the internal data register after the scan is completed.

\*3) The internal circuit and thermocouple input circuit are not insulated. Therefore, use the nongrounding type thermocouples and sheath tubes.

# FP-e Series

## Technical data

### ■ Transistor NPN output specifications (For Y0 to Y4)

Item	Description	
Insulation method	Optical coupler	
Output type	Open collector	
Rated load voltage	5 to 24 V DC	
Operating load voltage range	4.75 to 26.4 V DC	
Max. load current	0.5 A	
Max. surge current	1 A	
Output points per common	5 points/common	
OFF state leakage current	100 $\mu$ A or less	
ON state voltage drop	1.5 V or less	
Response time	OFF to ON	50 $\mu$ s or less (For Y0 and Y1), 1 ms or less (For Y2, Y3 and Y4)
	ON to OFF	50 $\mu$ s or less (For Y0 and Y1), 1 ms or less (For Y2, Y3 and Y4)
External power supply (For driving internal circuit)	Voltage	21.6 to 26.4 V DC
	Current	6 mA/point (For Y0 and Y1) 3 mA/point (For Y2, Y3, and Y4)
Surge absorber	Zener diode	
Operating indicator	LCD display (I/O monitor mode)	

### ■ Relay output specifications (Y5)

Item	Description	
Output type	Normally open (1 Form A)	
Rated control capacity	2 A 250 V AC, 2 A 30 V DC	
Output points per common	1 point/common	
Response time	OFF to ON	Approx. 10 ms
	ON to OFF	Approx. 8 ms
Life time	Mechanical	Min. $2 \times 10^7$ operations
	Electrical	Min. $10^5$ operations (resistive load)
Surge absorber	None	
Operating indicator	LCD display (I/O monitor mode)	

### ■ COM. port communication specifications \*1)

Item	Description
COM. port type	RS232C *2) RS485
Isolation status with the internal circuit	Non-isolated Isolated
Transmission distance	15 m 1200 m
Baud rate *3)	300, 600, 1200, 2400, 4800, 9600, 19200 bit/s 9600, 19200 bit/s *4)
Communication method	Half-duplex
Synchro system	Synchronous communication method
Transmission format	Stop bit: 1 bit/2 bit
	Parity: Not available/Available (Odd number/Even number)
	Data length 7 bit/8 bit
	Beginning code: STX available/STX not available
Data output order	Ending code: CR/CR+LF/not available/ETX
	Starting from 0 bits per character
No. of connected units	— 99 *5) *6)
Communication mode	<ul style="list-style-type: none"> <li>• General-purpose communication</li> <li>• Computer link</li> </ul>

- \*1) When communicating between FP-e and other devices, it is recommended to perform resend processing.
- \*2) For RS232C wiring, be sure to use shielded wires for higher noise immunity.
- \*3) Set the baud rate of RS485 with the FP-e system register and FP-e internal switch. Set the baud rate of RS232C with the FP-e system register.
- \*4) When sending a command from the FP-e is completed in RS485 communication, send a response from the receiving device to the FP-e after the following time has elapsed: 9600 bit/s: 2 ms or longer 19200 bit/s: 1 ms or longer It takes at least 1 scan time (at least 2 ms) for the FP-e to send back a response after received the command.
- \*5) When our C-NET Adapter or RS485 device other than recommended is connected in the system, the maximum connection number is limited to 32 units.
- \*6) For a RS485 converter on the computer side, SI-35 (from LINE EYE Co., Ltd.) is recommended. When SI-35 is used in the system, up to 99 units can be connected.

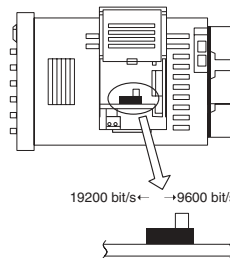

### ■ Dimensions

(mm)

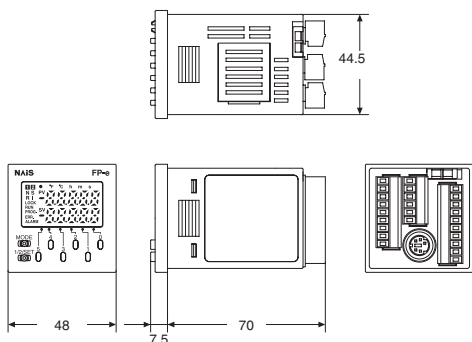

### ■ Wiring diagram

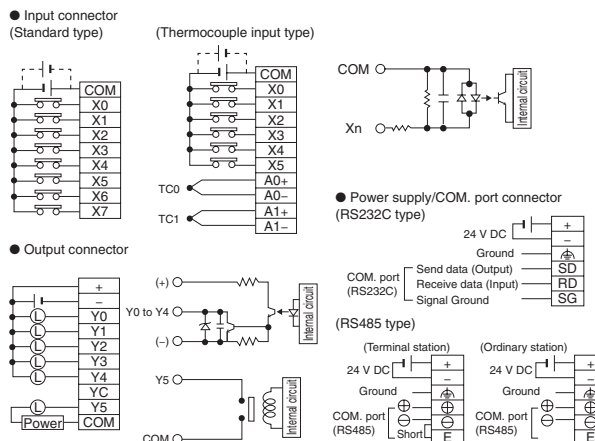

# FP-e Options

## Options

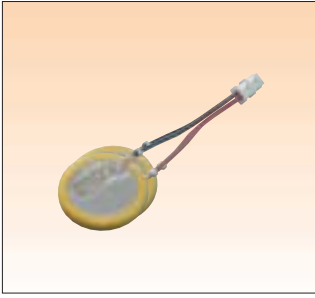

### Backup battery

Included with calendar timer type

Part No.: **AFPG804**

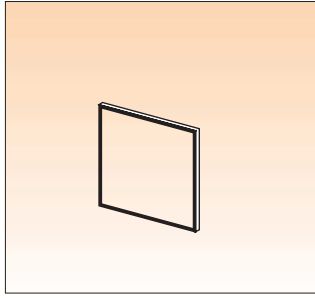

### Rubber gasket

Included with unit

Part No.: **ATC18002**

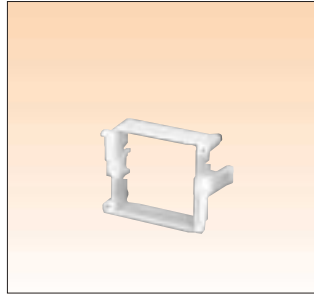

### Mounting frame

Included with unit

Part No.: **AT8-DA4**

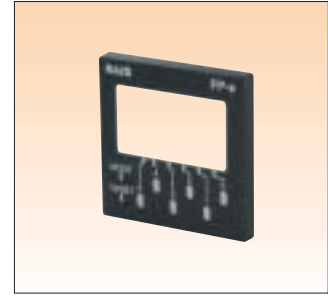

### Panel cover

Color: Black

Part No.: **AFPE803** (20 sets)

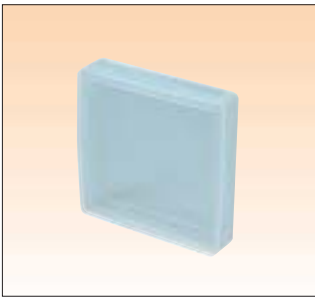

### Protective cover

Part No.: **AQM4803**

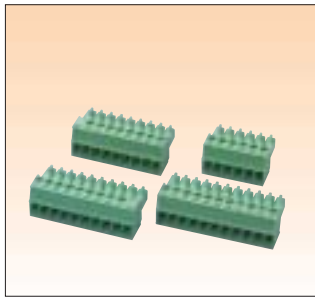

### Terminal socket set

4 type sockets, additional part

Part No.: **AFPE804**

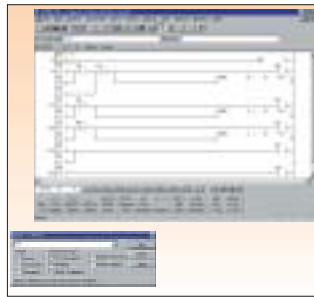

### Programming tool software

### Programming tool software Control FPWIN Pro

Part No.: FPWINPROSEN5  
(Small version, English manual)  
FPWINPROSFR5  
(Small version, French manual)  
FPWINPROSDE5  
(Small version, German manual)  
FPWINPROFEN5  
(Full version, English manual)  
FPWINPROFFR5  
(Full version, French manual)  
FPWINPROFDE5  
(Full version, German manual)

### Control FPWIN GR

Part No.: FPWINGRF2 (Full version)

### Programming cable

Part No.: **AFC8513**

## Matsushita Electric Works

### North & South America

#### USA

Aromat Corporation Head Office USA

629 Central Avenue, New Providence, N.J. 07974,