



Brand of NTN Group

Technical data

EX208G2L3

Insert bearings



Spherical outer diameter, fixing by eccentric locking collar, triple lip seal

VISUAL (S)

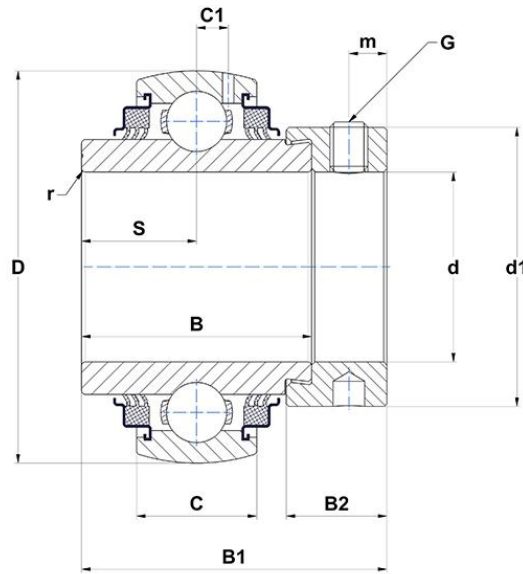

PRODUCT DEFINITION

Brand	SNR
B - Width of Inner Ring	42,8 mm
B1 - Overall width Inner Ring	56,3 mm
B2 - Width of eccentric locking collar/nut	18,3 mm
C - Width of Outer Ring	21 mm
C1 - Distance center of OR to center of lubrication zone	6,3 mm
d - Shaft diameter	40 mm
d1 - Outer dia of eccent. Lock. collar / nut of adapter sleeve	58 mm



NTN Europe

1 rue des Usines · BP 2017 · 74010 Annecy Cedex · France · Tel. +33 (0)4 50 65 30 00
S.A. au capital de 322 639 919 € · RCS ANNECY B 325 821 072 · Id. Fiscale : FR 48 325 821 072
SIRET 325 821 072 00015 · Code APE 2815 Z · Code NACE 28.15

PRODUCT DEFINITION

D - Outer diameter of OR	80 mm
G - Set screw size	M8x1
m - Distance to set screw	6,5 mm
r - Radius Inner Ring	1.1
S - Distance front side/bearing centre	21,4 mm
f0 - Factor	14
SW - Wrench size	4 mm

PRODUCT PERFORMANCE

C - Dynamic load rating	29600000 mN
C0 - Static load rating	18200000 mN
Operating temperature min.	253,15 °K
Operating temperature max.	373,15 °K

OTHER FEATURES

Mass	0,78 kg
Recommended tightening torque for set screw	11.5 N-m

BEARING FREQUENCIES

BPFO - Over rolling frequency on outer ring (60 rpm)	3.607035 Hz
BPFI - Over rolling frequency on inner (60 rpm)	5.392965 Hz
BSF - Over rolling frequency on rolling element (60 rpm)	4.84095457487135 Hz
BRF - Rotational frequency - rolling element (60 rpm)	2.42047728743567 Hz
FTF - Rotational frequency - cage (60 rpm)	0.400781666666667 Hz

