



Brand of NTN Group

Technical data

UCFA206

Bearing units



Grey cast housing, radial insert ball bearing with socket set screws, seal with slinger

KIT CONTENT

UC206G2, FA206

VISUAL (S)

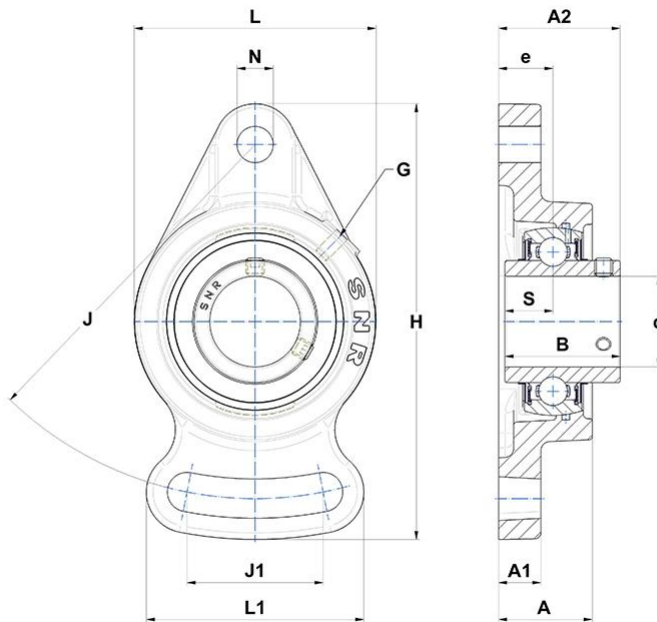

PRODUCT DEFINITION

Brand	SNR
A - Housing height	31 mm
A1 - Housing foot height / flange height	14 mm
A2 - Total height from mounting surface	40,2 mm
B - Width of Inner Ring	38,1 mm
d - Shaft diameter	30 mm



NTN Europe

1 rue des Usines · BP 2017 · 74010 Annecy Cedex · France · Tel. +33 (0)4 50 65 30 00
 S.A. au capital de 322 639 919 € · RCS ANNECY B 325 821 072 · Id. Fiscale : FR 48 325 821 072
 SIRET 325 821 072 00015 · Code APE 2815 Z · Code NACE 28.15

PRODUCT DEFINITION

e - Distance mounting surface to bearing center	18 mm
G - Grease fitting	M6x1
H - Housing length, width or diameter	144 mm
J - Mounting holes distance	117 mm
J1 - Center distance of slotted hole	58 mm
L - Housing width / diameter	80 mm
L1 - Housing width at slotted hole	72 mm
N - Mounting hole dimension	12 mm
S - Distance front side/bearing centre	15,9 mm

PRODUCT PERFORMANCE

C - Dynamic load rating	19500000 mN
C0 - Static load rating	11200000 mN
Operating temperature min.	253,15 °K
Operating temperature max.	373,15 °K

OTHER FEATURES

Mass	0,92 kg
Recommended tightening torque for set screw	5.5 N-m

