

## Features

- Input Voltage 90~305V AC
- Built in Active PFC Function
- Forced air cooling by build-in DC fan
- Approved to UKCA, CE, CB & cURus
- Efficiency up to 90%
- Safety Approved to UL/IEC 62368-1 BS EN/EN 62368-1
- Protection: OLP, OVP, OTP SCP
- Three Years Warranty

## RS PRO Enclosed AC/DC

RS Stock No.: 0625751



RS Professionally Approved Products bring to you professional quality parts across all product categories. Our product range has been tested by engineers and provides a comparable quality to the leading brands without paying a premium price.

500W Enclosed AC/DC Power Supply (PSU) is certified to UKCA, CE & IEC 62368-1/BS EN62368-1/EN 62368-1 Standards and complies with the relevant Efficiency Regulations. These are primarily used in ITE, Audio & Video Industries.

## Input Specifications

Rated Voltage Range	100-277VAC/127-430VDC
AC Voltage Range	90-305VAC/127-430VDC
Frequency Range	50/60Hz
AC Current	5.3A/115VAC 2.65A/230VAC
Inrush Current	Cold Start 40A/200us at 230VAC 50Hz Cold Start 20A/200us at 115VAC 50Hz
Leakage Current	<2mA/240VAC
Power Factor(Typ.)	>0.95/230VAC at full load >0.98/115VAC at full load

## Output Specifications

Setup, Rise, Hold up	1.5s,80ms,18ms/230VAC(at full load) 3.0s,80ms,14ms/115VAC(at full load)
Voltage Tolerance	±2.0
Line Regulation	±0.5%
Load Regulation	±0.5%

## Protection Specifications

Over Load	105~130%Rated Output Power
	Constant current limiting recovers automatically after fault condition is removed.
Short Circuit	Hiccup mode, recovers automatically after fault condition is removed.
Over Voltage	115~135%Rated Output Voltage
	Shut down o/p voltage, re-power on to recover.
Over Temperature	Shut down o/p voltage, recovers automatically after temperature goes down.

## Environmental

Working TEMP.	-30 ~ +70□(Please refer to "Derating Curve" section)
Working Humidity	20 ~ 95%RH Non-condensing
Storage TEMP. Humidity	-40 ~ +85□, 10 ~ 95%RH Non-condensing
TEMP. Coefficient	0±03%/(0 ~ 50□) on load output
Vibration	Component: 10 ~ 500Hz, 2G 10min./1cycle, 60min. each along X, Y, Z axes
Safety Protection	Class I
Over Voltage Category	OVC III / According to EN62368-1;altitude up to 2000 meters

## Safety & EMC

Safety Standards	BS EN/EN62368-1
Withstand Voltage	I/P-O/P:3KVAC/1min I/P-FG:2KVAC/1min O/P-FG:0.5KVAC/1min
Isolation Resistance	I/P-O/P:100M Ohms / 500VDC / 25□/ 70% RH
EMC Emission	BS EN/EN55032 (CISPR32) Class B, BS EN/EN61000-3-2 Class A,BS EN/EN61000-3-3
EMC Immunity	BS EN/EN61000-4-11 Criteria B, BS EN/EN61000-4-2,3,4,5,6,8 Criteria A

## Other Specifications

Packing	1.3kg/pcs; 54 x 30 x 24 cm; 9pcs/carton
---------	---

---

<b>Dimension (LxWxH)</b>	230 x 127 x 40.5 mm
<b>MTBF</b>	176.8Khrs min. MIL-HDBK-217F(25□)
<b>Housing material</b>	Aluminium / steel
<b>Connection Method</b>	Input & Output , Screw connection
<b>Terminal</b>	Input 3 pins / Output 6 pins
<b>Wire</b>	Input 22-12AWG / 0.3246-2.05mm <sup>2</sup> Output 22-10AWG / 0.3246-4mm <sup>2</sup>
<b>Stripping length</b>	Input 5-6mm, output 3-4mm
<b>Tightening torque</b>	Input 1.47Nm, output 1.47Nm

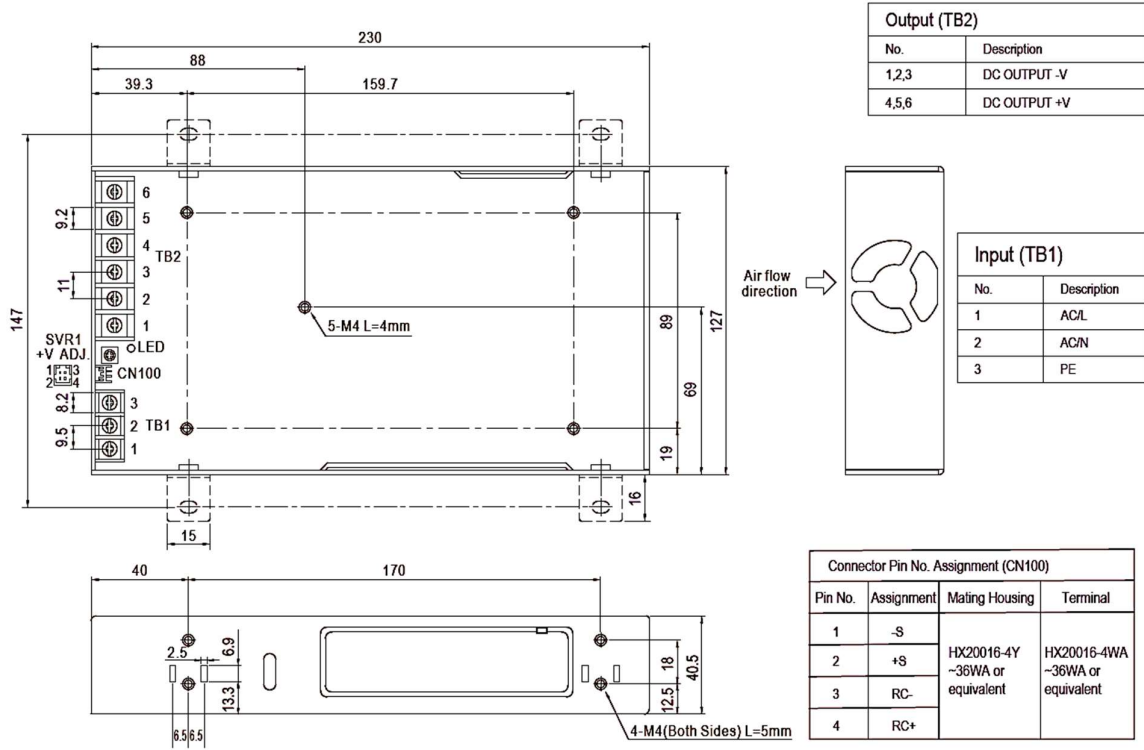

**POWER SUPPLY**

INPUT: 100-277VAC 50/60Hz 5.9A  
OUTPUT: 12.0VDC 41.7A 500.4W

CE IP20

MADE IN CHINA 2025.02

V+ V- +V ADJ. N L

fosc: 100KHz

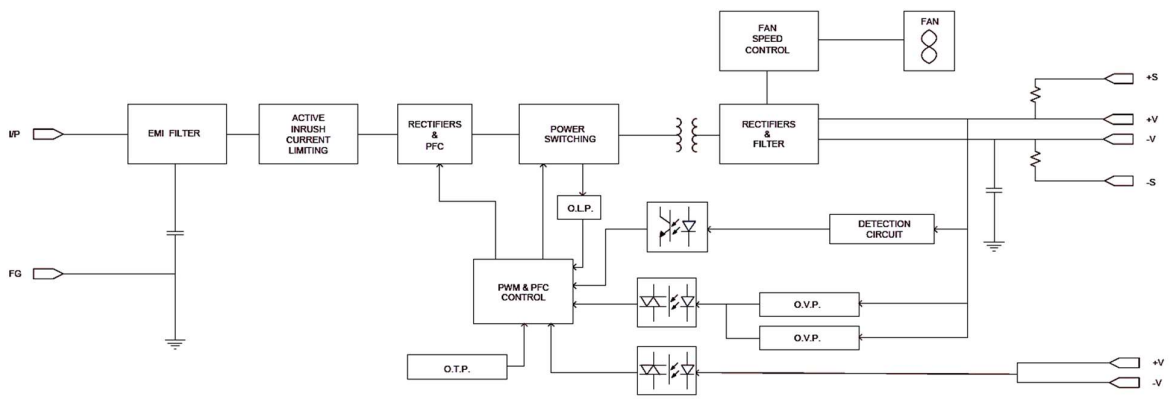

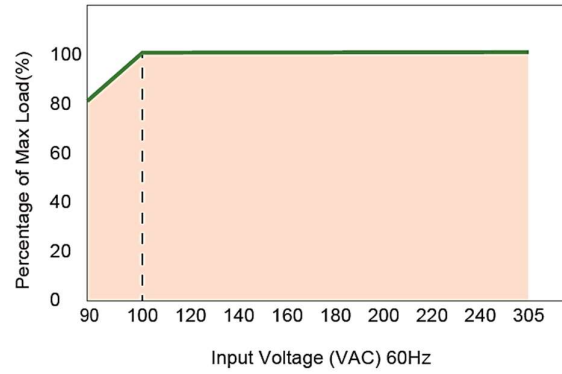
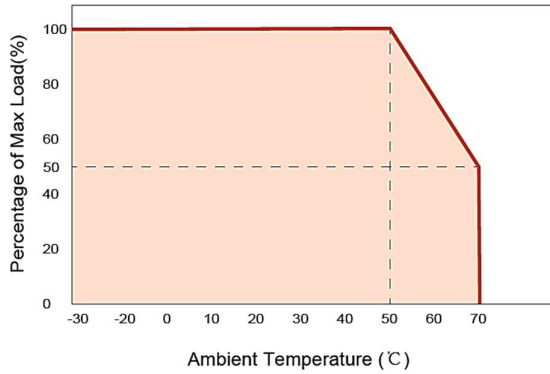

### 1. Remote Control

The PSU can be turned ON/OFF by using the "Remote Control" function.

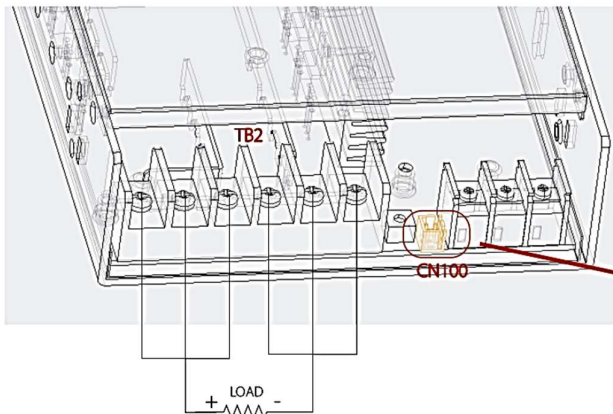

Between RC-(pin3) and RC+(pin4) on CN100	PSU Status
SW OFF (0 - 0.8VDC) or open	ON
SW ON (4 - 10V)	OFF

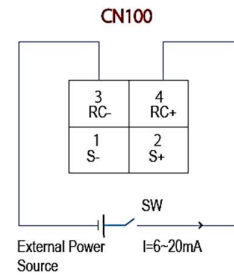

### 2. Remote Sense

The remote sensing compensates voltage drop on the load wiring up to 0.3V

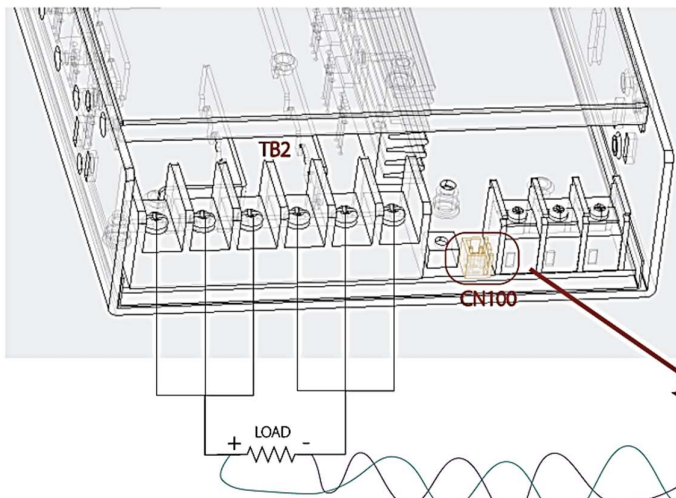

CN100

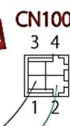
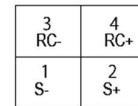

Sense lines should be twisted in pairs