

## HYPRA Prisinter 16/32/63 A

Cat. No(s): 519 10 - 520 02/03/04/12/49/59 - 522 02/03/04/13/14/49/59  
527 02/03/05/13 - 529 03/04/06/07/13/14/49/59  
536 01/02/03/04/05/06 - 537 03/06/07/49  
538 00/01/09/12

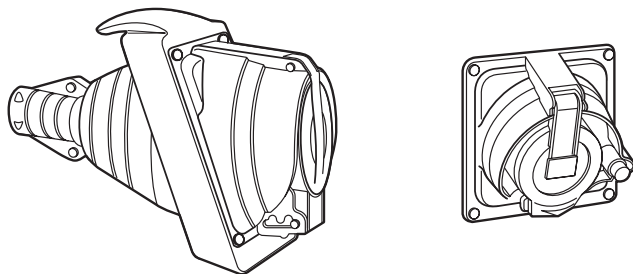

### CONTENTS

Page

1. General characteristics	1
2. Range	1
3. Dimensions	2-3
4. Use	3
5. Technical characteristics	4-5
6. Normes and decree	5
7. Accessories	5

## 1. GENERAL CHARACTERISTICS

- Compact system combining a socket and a switch.
- Prohibits any connection or disconnection on load.
- For replacing former Martin Lunel Prisinter 16 A and 32 A in panels without modifying the central drilling (except 16 A 3P+N+E).
- The same dimensions for Prisinter 32 A and 63 A
- Padlockable cover
- Option of making up an extension using the mobile Prisinter
- Material: plastic and metal
- IK 09 (plastic), IK 10 (metal).

### Prisinter safety

Even if the regulations only require it over 32 A, socket disconnection off load definitely provides an additional level of safety which means Hypra Prisinters are recommended for lower currents (16 A and 32 A), without affecting overall dimensions.

In compliance with the regulations (NFC 15-100 and the decree dated 14 Nov 1988), all the live conductors, neutral included, are cut off load. Naturally, protection circuit continuity (earth) is ensured.

The safety level provided by the systematic and total cutting of all the live poles, with sockets not connected, is equivalent to that provided by safety shutters on domestic sockets (child safety, use in public places, such as schools, gyms).

## 2. RANGE

### 2.1 Current range

#### Plastic and metal fixed Prisinter 16 A

		Plastic		Metal	
		Base	Box	Base	Box
200 V / 250 V~	2P + E	520 02	520 49	520 12	520 59
	3P + E	520 03	520 49		
	3P + N + E	520 04	522 49		
380 V / 415 V~	2P + E	522 02	520 49		
	3P + E	522 03	520 49	522 13	520 59
	3P + N + E	522 04	522 49	522 14	529 59

#### Plastic and metal fixed Prisinter 32 A

		Plastic		Metal	
		Base	Box	Base	Box
200 V / 250 V~	2P + E	527 02	529 49		
	3P + E	527 03	529 49	527 13	522 59
380 V / 415 V~	3P + E	529 03	529 49	529 13	522 59
	3P + N + E	529 04	529 49	529 14	522 59

## 2. RANGE (continued)

### 2.1 Current range (continued)

#### Plastic and metal fixed Prisinter 63 A

		Plastic sockets	Metal sockets
200 V / 250 V~	2P + E	536 01	538 12
	3P + E	536 02	
380 V / 415 V~	3P + E	536 03	538 00
	3P + N + E	536 04	538 01

### Boxes

Plastic	Metal
537 49 simple box	538 09 simple box
537 03 for tapping	538 03 for tapping

### Mobile Prisinters

		32 A	63 A
200 V / 250 V~	2P + E	527 05	536 05
	3P + E		536 06
380 V / 415 V~	3P + E	529 06	537 06
	3P + N + E	529 07	537 07

### 2.2 Equivalence of catalogue numbers

#### Fixed Prisinters

		Plastic		Metal	
		Former	Compact version	Former	Compact version
200 V / 250 V~	2P + E	537 12	536 01	536 12	538 12
	3P + E	537 11	536 02		
380 V / 415 V~	3P + E	537 13	536 03	538 13	538 00
	3P + N + E	537 14	536 04	538 14	538 01

#### Mobile Prisinters

		Former	Compact version
380 V / 415 V~	3P + E	537 93	537 06
	3P + N + E	537 94	537 07

### Boxes

	Until 2001	2002	Now
Plastic	537 03	537 49	537 49: simple box 537 03: for tapping
Metal		538 09	538 09: simple box

### 3. DIMENSIONS

#### 3.1 Fixed Prisinters 16 A, 32 A and 63 A

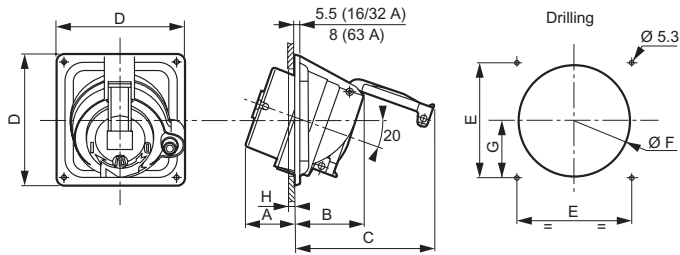

	Material	Weight (kg)	A	B	C	D	E	F		G	H max.
								min.	max.		
<b>16 A</b>											
2P+E	Plastic	0.42	46	70	132	115	100	92	98	46	6 to 10
	Metal	1.25									
3P+E	Plastic	0.48	46	70	138	115	100	92	96	46	6 to 10
	Metal	1.33									
3P+N+E	Plastic	0.57	46	75	156	125	110	102	106	51.5	7
	Metal	1.47									
<b>32 A</b>											
2P+E	Plastic	0.57	54	77	153	143	125	115	122	58.5	10 to 20
	Metal	1.47									
3P+E	Plastic	0.61	54	77	153	143	125	115	122	58.5	10 to 20
	Metal	1.5									
3P+N+E	Plastic	0.65	55	79	169	143	125	119	122	58.5	9 to 13
	Metal	1.8									
<b>63 A</b>											
2P+E	Plastic	0.87	55	99	205	143	125	120	122	59.5	10 to 20
	Metal	1.5									
3P+E	Plastic	0.95	55	99	205	143	125	120	122	59.5	10 to 20
	Metal	1.85									
3P+N+E	Plastic	0.98	55	99	205	143	125	120	122	59.5	10 to 20
	Metal	2.2									

#### 3.2 Mobiles Prisinters 32 A and 63 A

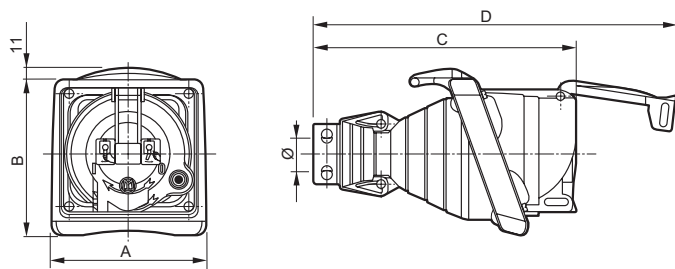

	Weight (g)	Dimensions				Clamping/Fixing Ø
		A	B	C	D	
<b>32 A</b>						
2P+E	1.315	160	162	224	313	10 to 18
3P+E	1.350					
3P+N+E	1.385					
<b>63 A</b>						
2P+E	1.735	160	162	274	377	16 to 26
3P+E	1.768					
3P+N+E	1.800					

### 3. DIMENSIONS (continued)

#### 3.3 Boxes for Prisinter 16/32/63 A Reversible box for Prisinter 16 A

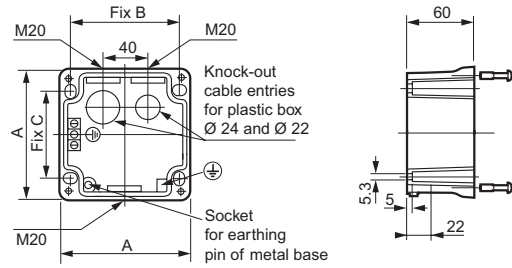

Equipped with:

- 1 internal earthing strip with 2 connections for plastic and metal box.
- 1 external earthing terminal for metal box (decree of 14/11/88).

	Material	Weight (kg)	A	B	C
2 P + E	Plastic	0.14	115	97	78
	Metal	0.8	115	97	78
3 P + N + E	Plastic	0.16	125	107	88
	Metal	0.9	125	107	88

#### Reversible box for Prisinter 32 A

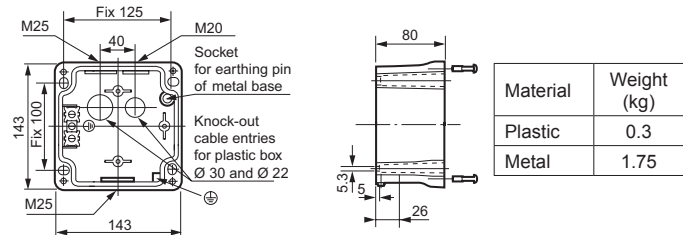

Equipped with:

- 1 internal earthing strip with 2 connections for plastic and metal box.
- 1 external earthing terminal for metal box (decree of 14/11/88).

#### Reversible box for Prisinter 63A

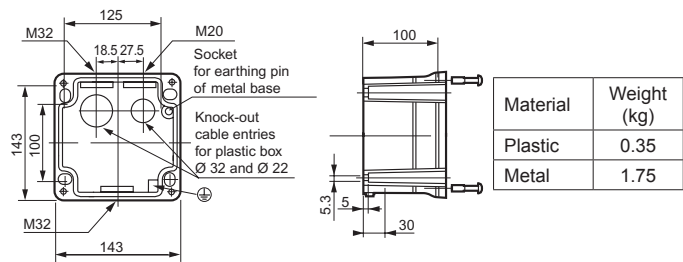

Equipped with:

- 1 external earthing terminal for metal box (decree of 14/11/88).

### 3. DIMENSIONS (continued)

#### 3.3 Boxes for Prisinter 16/32/63 A (continued)

Reversible box for Prisinter BT 63 A (through power supply).

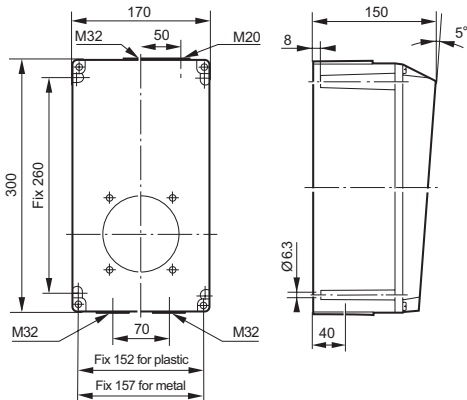

Material	Weight (kg)
Plastic	2
Metal	4.3

Equipped with:

- 1 external earthing terminal for metal box (decree of 14/11/88).
- 1 earth terminal block for plastic and metal box.

### 4. USE

#### 4.1 Running

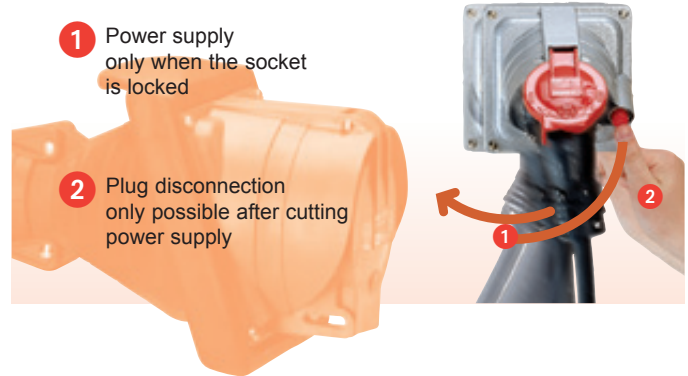

#### 4.2 Extension 32 and 63 A

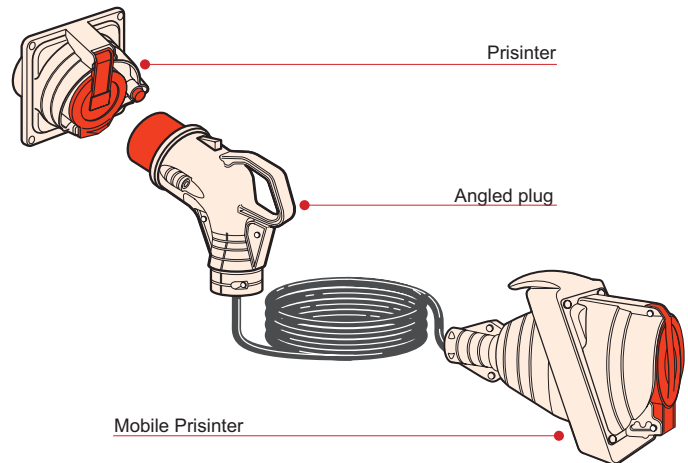

**Advised in 32 A....  
 COMPULSORY in 63 A!!**  
 (Decree of 14/11/88)

The Hypra mobile Prisinter is for making up extensions that maintain the same functionalities as the fixed Prisinter at a distance.



**5. TECHNICAL CHARACTERISTICS**

**5.1 Protection index**

- IP 55 flap shut, IP 44 plug connected
- IP 55 connected with an Hypra angled plug 16/32 A IP 67/66-55
- IP 54 connected with an Hypra straight plug 16/32 A IP 66/67-55

**5.2 Resistance to glow wire and dielectric strength**

- Glow wire:
  - 960° C for the live part supports.
  - 650° C for other parts.
- Dielectric strength: 3000 V 50 Hz

**5.3 Temperatures**

- Installation: - 20° C / + 40° C
- Use: - 20° C / + 100° C

**5.4 Resistance to UV**

- Radiation intensity: 550 W/m<sup>2</sup>
- Test duration: 168 heures
- Infrared and ultra-violet filter tested under.

**5.5 Ageing test**

Thermoplastic material: ageing 7 days at 80° C.  
 Lids' springs resistance: 5000 openings / closings.  
 Seal resistance: ageing 10 days at 70° C.

**5.6 Locking / unlocking**

**• According to IEC 60309-1**

Prisinters 16 A: 5000 handlings on power on.  
 Prisinters 32 A: 1000 handlings on power on + 1000 handlings on power off.  
 Prisinters 63 A: 1000 handlings on power on + 1000 handlings on power off.

**• According to IEC 60947-3**

AC3 use imposes 6000 cycles on load for all intensities.

**5.7 Breaking capacity**

AC1: Non-inductive or weakly inductive loads, resistance ovens (according to IEC 60947.1-4).  
 AC23: Loads made by motors or other highly inductive loads (according to IEC 60947-3).  
 AC3: Squirrel-cage motor: starting, cutting of started motors (according to IEC 60947.1-4).

**Breaking capacity under 3 x 400 V~**

	16 A	32 A	63 A
AC1	16 A	32 A	63 A
AC23 AC3	8.4 kW	16.8 kW	33 kW

**5.8 Terminal connection**

	16 A	32 A	63 A
Fixed Prisinter (rigid)	min. 1.5 max. 4	min. 2.5 max. 10	min. 6 max. 25
Mobile Prisinter (flexible)	- -	min. 2.5 max. 6	min. 6 max. 16

Prisinter 63 A : terminal connection with Allen key 3 mm.

**Reminder: standard EN 60309.1 § 25.5**

Current-carrying parts, **other than terminals**, must be made of:  
 - either copper  
 - or alloy containing at least 50% copper  
 - or another metal resisting corrosion as well as copper and having at least equivalent mechanical properties.

**5. TECHNICAL CHARACTERISTICS (continued)**

**5.9 Material resistance**

	Main material	Lid
<b>Aqueous solutions</b>		
Cold water	++	++
Warm water	+	-
Vapour	-	--
Saltwater 5 %	+	+
Hydrogen peroxide	-	-
Water + detergent	++	
Water + surfactants	+	
Formic aldehyde	++	++
<b>Alcohols</b>		
Ethanol	++	++
Methyl alcohol	+	-
Propanol	++	+
Butyl alcohol	++	+
<b>Glycols</b>		
Ethylene glycol	-	++
Phenols	--	
Cresols	-	
<b>Bases</b>		
Ammoniac	+	+
Sodium hydroxide	+	--
Sodium hypochlorite (bleach 12°)	+	
Potassium hydroxide	+	+
<b>Oxydizing strong acids</b>		
Concentrated acetic acid	--	+
Nitric acid 5 %	-	-
Sulfuric acid 10 %	-	+
Muriatic acid 30 %	-	+
Perchloric acid 70 %	-	
Hydrofluoric acid 70 %	--	
Chromic acid 50 %	--	-
Phosphoric acid 30 %	-	
<b>Weak acids</b>		
Diluted acetic acid < 25 %	-	+
Citric acid	+	+
Lactic acid	-	+
Formic acid	--	-
Uric acid	++	
<b>Oils and lubricants - Animal origin</b>		
Lard	++	++
Butter, cream	++	++
<b>Oils and lubricants - Vegetal origin</b>		
Linseed oil	++	++
Peanut / Olive	++	++
Castor oil	++	++
Glycerin	++	
<b>Oils and lubricants - Mineral origin</b>		
Paraffin	++	++
Engine oil	++	+
Silicone oil	+	++
Cutting oil	++	++
Hydraulic fluid	++	++
<b>Hydrocarbons</b>		
Unlead petrol	++	++
Diesel oil	++	++
Kerosen	++	++
White spirit	++	+
<b>Chlorinated solvents</b>		
Trichloroethylene	+	-
Trichloroethane	++	--
Perchloroethylene	++	-
Methyl chloride	-	--
Carbon tetrachloride	+	-
Chloroform	+	-

**5. TECHNICAL CHARACTERISTICS** (continued)

**5.9 Material resistance** (continued)

	Main material	Lid
<b>Aromatic solvents</b>		
Benzen .....	++	+
Toluene .....	++	+
Xylene .....	++	+
<b>Aliphatic solvents</b>		
Hexane .....	++	+
Fluoride solvents		
Trichlorofluoridmethan .....	--	
<b>Ketones</b>		
Acetone .....	+	+
Methyl Etyl Ketone .....	+	+
Ethyl acetate .....	+	+
<b>Turpens</b>		
Turpentine .....	+	-

**Resistance to chemical agents at ambient temperature according to risks of exposure with spraying.**

- (++) excellent resistance (continue exposure)
- (+) good resistance (durable exposure)
- (-) limited resistance (possible short exposure)
- (--) Low resistance (exposure to be avoided)

**6. CONFORM WITH STANDARDS AND ORDER**

- Satisfies the requirements of the decree dated 14 Nov 1988 on worker protection.
- Complies with standards NF EN 60309.1 and IEC 60309.1
- Complies with standards NF EN 60309.2 and IEC 60309.2
- Complies with standards NF EN 60529 and IEC 60529 (IP)
- Complies with standard NF EN 62262 and IEC 62262 (IK)
- Complies with standard NF EN 60947-1 and NF EN 60947-3.

**7. ACCESSORIES**

**Padlock**

A padlock can be fitted to prevent access to the socket (e. g. public places).



Example:  
 Cat. No.: **520 02** blacked with a padlock **227 97**

**Auxiliary signalling contacts**

All Prisinters, whatever the rating, can be equipped with one or two auxiliary signalling contacts (NO + NC) which enable the switch position to be offset.

- low voltage: 10 (1.5) A ..... Cat. No. 521 96
- Min. and max. use temperature: - 20° C / + 85° C
- Snap fitting.
- Connection 1.5 mm<sup>2</sup> flexible lugs provided.

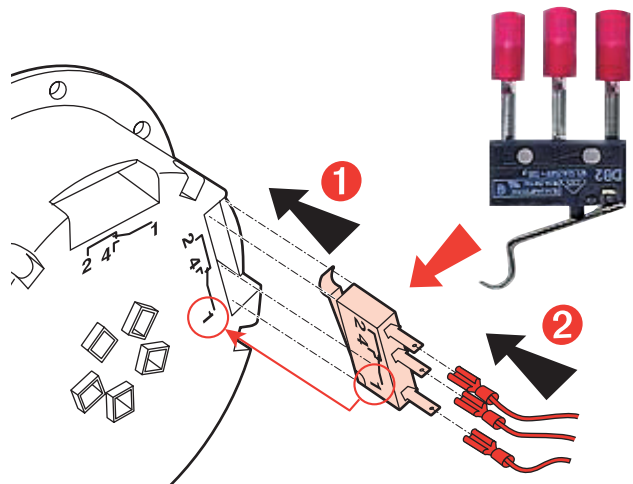

**Pushbutton (reinforced protection)**



Dust IP can be increased by rubber protection

To special request