

2-215882-6 ✓ ACTIVE

AMP-LATCH | AMP-LATCH - NOVO

TE Internal #: 2-215882-6

Wire-to-Board, 26 Position, 2.54 mm [.1 in] Centerline, 2 Row,
Receptacle, Wire & Cable, Signal, AMP-LATCH - NOVO, Ribbon
Cable Connectors

[View on TE.com >](#)



Connectors > PCB Connectors > Wire-to-Board Connectors > FFC, FPC & Ribbon Connectors > Ribbon Cable Connectors

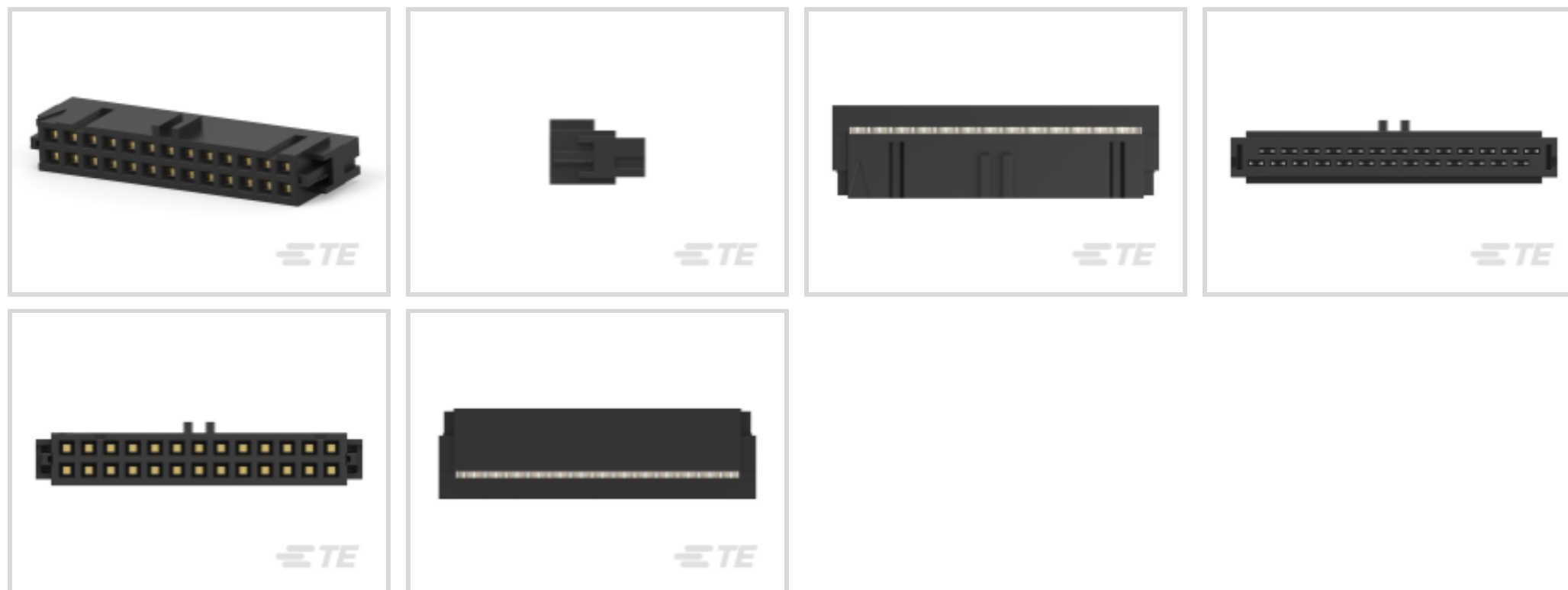

Connector System: **Wire-to-Board**

Number of Positions: **26**

Centerline (Pitch): **2.54 mm [.1 in]**

Row-to-Row Spacing: **2.54 mm [.1 in]**

Number of Rows: **2**

Features

Product Type Features

Connector Product Type	Connector Assembly
Connector System	Wire-to-Board
Connector & Housing Type	Receptacle
Connector & Contact Terminates To	Wire & Cable

Configuration Features

Number of Positions	26
Number of Rows	2

Body Features

Primary Product Color	Black
-----------------------	-------

Contact Features

	30 μ m
Contact Mating Area Plating Material	Gold (Au)
Mating Pin Diameter	.64 mm[.025 in]
Wire Contact Termination Area Plating Thickness	2.54 μ m[100 μ m]



Wire Contact Termination Area Plating Material	Tin
Mating Square Post Dimension	.64 mm[.025 in]
Contact Current Rating (Max)	1 A

Termination Features

Termination Method to Wire & Cable	Insulation Displacement (IDC)
------------------------------------	-------------------------------

Mechanical Attachment

Mating Alignment Type	Polarization
Mating Retention	Without
Connector Mounting Type	Cable Mount (Free-Hanging)

Housing Features

Centerline (Pitch)	2.54 mm[.1 in]
--------------------	----------------

Dimensions

Row-to-Row Spacing	2.54 mm[.1 in]
--------------------	----------------

Usage Conditions

Operating Temperature Range	-55 – 125 °C[-67 – 257 °F]
-----------------------------	----------------------------

Operation/Application

Circuit Application	Signal
---------------------	--------

Product Compliance

[For compliance documentation, visit the product page on TE.com>](#)

EU RoHS Directive 2011/65/EU	Compliant
EU ELV Directive 2000/53/EC	Compliant
China RoHS 2 Directive MIIT Order No 32, 2016	有害物质含量符合标准要求 No Restricted Substance(s) Above Threshold
EU REACH Regulation (EC) No. 1907/2006	Current ECHA Candidate List: JUNE 2025 (250) Candidate List Declared Against: JUNE 2025 (250) Does not contain REACH SVHC
Halogen Content	Not Low Halogen - contains Br or Cl > 900 ppm.
Solder Process Capability	Not applicable for solder process capability

Product Compliance Disclaimer



This information is provided based on reasonable inquiry of our suppliers and represents our current actual knowledge based on the information they provided. This information is subject to change. The part numbers that TE has identified as EU RoHS compliant have a maximum concentration of 0.1% by weight in homogenous materials for lead, hexavalent chromium, mercury, PBB, PBDE, DBP, BBP, DEHP, DIBP, and 0.01% for cadmium, or qualify for an exemption to these limits as defined in the Annexes of Directive 2011/65/EU (RoHS2). Finished electrical and electronic equipment products will be CE marked as required by Directive 2011/65/EU. Components may not be CE marked. Additionally, the part numbers that TE has identified as EU ELV compliant have a maximum concentration of 0.1% by weight in homogenous materials for lead, hexavalent chromium, and mercury, and 0.01% for cadmium, or qualify for an exemption to these limits as defined in the Annexes of Directive 2000/53/EC (ELV). Regarding the REACH Regulation, the information TE provides on SVHC in articles for this part number is based on the latest European Chemicals Agency (ECHA) 'Guidance on requirements for substances in articles' posted at this URL: <https://echa.europa.eu/guidance-documents/guidance-on-reach>

Compatible Parts

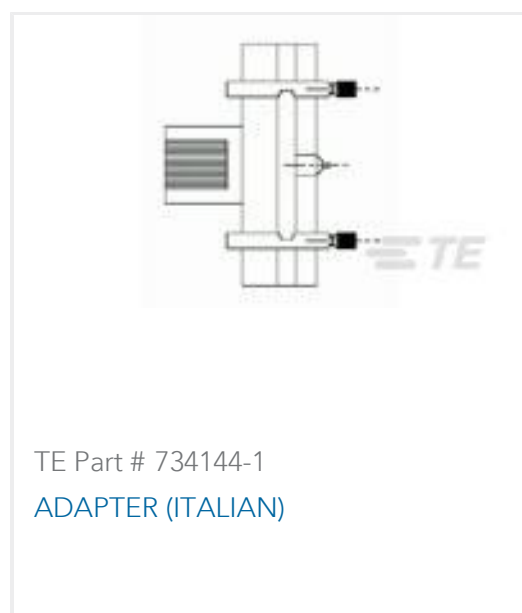

Also in the Series | AMP-LATCH - NOVO

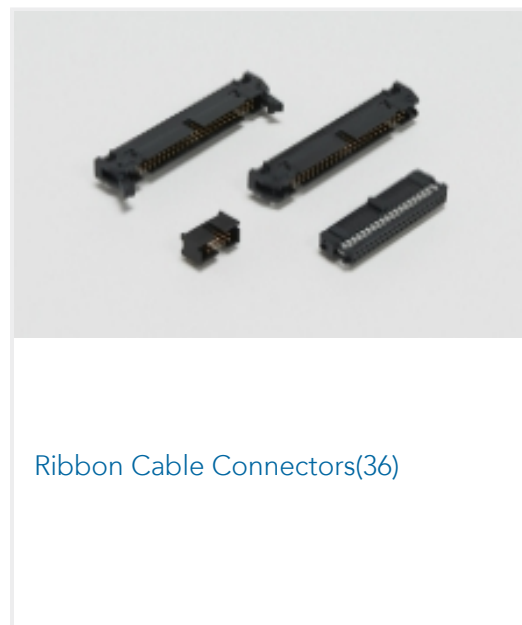

Customers Also Bought

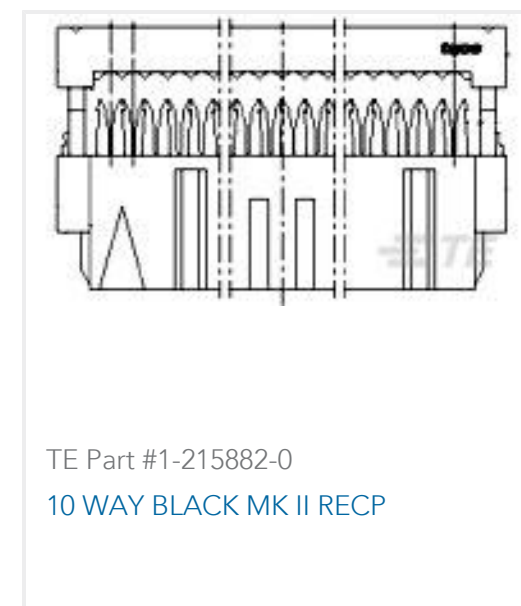
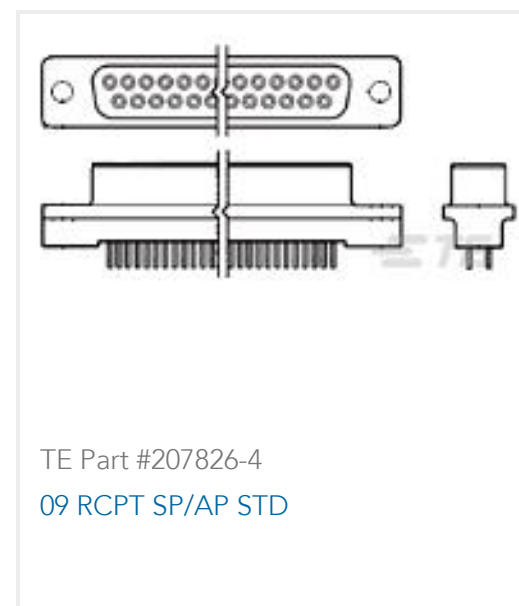

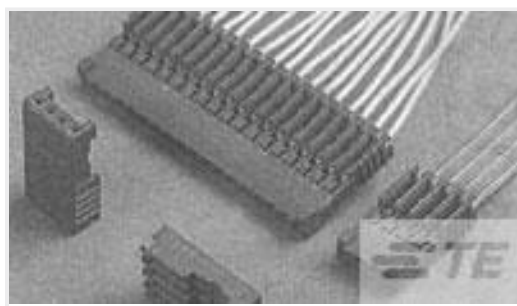

TE Part #281786-5
PLUG HE14 IDC 180 5 P AWG 28-26



TE Part #5-338309-2
9P.HDP20 PLUG ASSY



TE Part #1734100-7
Champ050 series,68pos,Au over PdNi



TE Part #1734101-7
Champ050 series,68pos,Au over PdNi

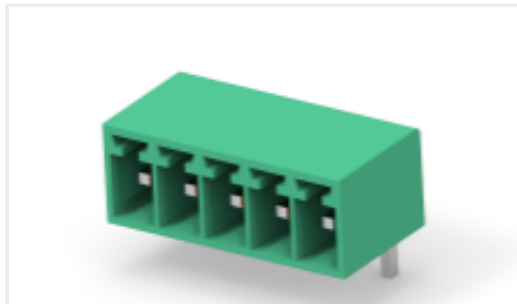

TE Part #2350514-5
5POS TB HDR 90 DEG, PITCH 3.5 & TL 3.5mm



TE Part #3-100103-4
34P.A/LSTRAIN REL.

Documents

Product Drawings

26 WAY BLACK MK II RECP

English

CAD Files

Customer View Model

[ENG_CVM_CVM_2-215882-6_G.2d_dxf.zip](#)

English

3D PDF

3D

Customer View Model

[ENG_CVM_CVM_2-215882-6_G.3d_igs.zip](#)

English

Customer View Model

[ENG_CVM_CVM_2-215882-6_G.3d_stp.zip](#)

English

By downloading the CAD file I accept and agree to the [Terms and Conditions](#) of use.

Product Specifications

Application of AMP-LATCH, Ribbon Cable Connectors

English

Application Specification

English

Agency Approvals

UL Report

English

