



Every part matters

EN

Installation & Operating Instructions DIGITAL MULTI-FUNCTION INSTRUMENT Programmable Multi-function Digital Panel Meter

Article codes

136-5381 Digital Multi-Function Meter, 96x96, 3Ph, V A F & P
136-5382 Digital Multi-Function Meter, 96x96, 3Ph, V A F & P with Limit Relay/Switch option

TABLE 1:

Measured Parameters	Units of measurement
System Voltage	Volts
System Current	Amps
Frequency	Hz
Voltage L1-N(4wire only)	Volts
Voltage L2-N(4wire only)	Volts
Voltage L3-N(4wire only)	Volts
Voltage L1-L2	Volts
Voltage L2-L3	Volts
Voltage L3-L1	Volts
Current L1	Amps
Current L2	Amps
Current L3	Amps
System Active Power(kW)	KW
Active Power L1	KW
Active Power L2	KW
Active Power L3	KW
System reactive Power(KVAR)	KVAr
Reactive Power L1 (KVAR)	KVAr
Reactive Power L2 (KVAR)	KVAr
Reactive Power L3 KVAR	KVAr
System Apparent Power (KVA)	KVA
Apparent Power L1 (KVA)	KVA
Apparent Power L2 (KVA)	KVA
Apparent Power L3 (KVA)	KVA
System phase angle	Deg
Phase angle L1	Deg
Phase angle L2	Deg
Phase angle L3	Deg
System power factor	—
Power factor L1	—
Power factor L2	—
Power factor L3	—
RPM	RPM
Max. Value System Voltage	V
Max. Value System Current	A
Min. Value System Voltage	V
Min. Value System Current	A
Run Hours	Hrs
ON Hours	Hrs
No. of Auxiliary Interruptions	Counts

1. INTRODUCTION

The RS Pro is a panel mounted 96 x 96mm DIN Quadratic Digital Panel Meter, which measures important electrical parameters in 3 ph 4 wire / 3 wire / 1ph Network and replaces the multiple analog panel meters. It measures electrical parameters like AC voltage, Current, Frequency, Active, reactive, apparent power, phase angle, power factor & many more.

The instrument integrates accurate measurement technology (All Voltages & current measurements are True RMS upto 15th Harmonic) with 3 line 4 digits Ultra high bright LED display with Clearly visible Annunciated units with bright LED from Back side.

The RS Pro can be configured and Programmed on site for the following : PT Primary, PT Secondary, CT Primary, CT Secondary (5A or 1A) and System Type 3 phase 3W or 4W or single phase system.

The front panel has four push buttons for user interface to scroll through the available parameters.

These four keys has function as follow :

1. V : Selects & Scrolls through Voltage parameters
2. A : Select phase Current Parameters Display.
3. P : Select & Scrolls phase & system Power parameters : Active power, apparent power, reactive power, phase angle, power factor, then system Apparent Reactive,
4. Sys : Select & Scroll through System parameters :

Voltage-Current-Frequency, Hi values of system voltage and current, min values of system Voltage and current, RPM, run Hour, ON hour and no. of interruptions and back to System

Voltage-Current Frequency screen

The RS Pro come with 14mm display and units annunciated from back side, which enables to take reading from long distance. The problem with conventional LED annunciators is overcome with the RS Pro.

2. Measurement Reading Screens

In normal operation the user is presented with the measurement reading screens. These screens may be scrolled through one at a time by pressing the "A" key for Currents, "V" key for Voltages, "P" key for phase active Reactive & apparent power. System Apparent, reactive & Active powers, "Sys" key for System Voltage-Current-Frequency, max. and min. Values of system Voltage and Current, RPM, Run hours, O. N hours, No. of Aux interruptions.

a. "V" Key:

Screen 1 : Voltage Line to Neutral
(For 3Ph4 Wire only)



Screen 2 : Voltage Line to Line
(For 3Ph 4Wire & 3 Wire)



b. "A" Key:

Screen 1 : Line Currents



c. "P" Key:

Screen 1 : Phase Active power



Screen 2 : Phase Apparent power
(For 3Phase 4 wire only)



Screen 3 : Phase Reactive power
(For 3Phase 4 wire only)



Screen 4 : Phase Angle
(For 3Phase 4 wire only)



Screen 5 : Phase power factor
(For 3Phase 4 wire only)



Screen 6 : System powers
(Apparent, reactive, active)



Screen 7 : System Phase Angle
& power factor (3P4W & 3W)



d. "Sys" Key:

Screen 1 : System Values
(Voltage, Current, Frequency)



Screen 2 : Max. Values



Screen 3 : Min. Values



Screen 4 : RPM Measurement



Screen 5 : Run Hours



Screen 6 : ON Hours



Screen 7 : No. of Interruptions

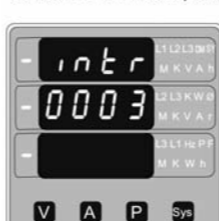

3. Programming

The following sections comprise step by step procedures for configuring the RS Pro for individual user requirements.

To access the set-up screens press and hold the "V" and "A" Keys Simultaneously. This will take the User into the Password Entry Screen (Section 3.1)

3.1. Password Protection

Password protection can be enabled to prevent unauthorized access to set-up screens, by default password protection is not enabled.

Password protection is enabled by selecting a four digit number other than 0000, setting a password of 0000 disables the password protection.

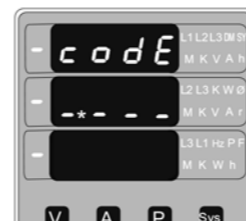

Enter Password, prompt for first digit. (* Denotes that decimal point will be flashing).

Press the "V" key to scroll the value of the first digit from 0 through to 9, the value will wrap from 9 round to 0.

Press the "A" key to advance to next digit.

In the special case where the Password is "0000" pressing the "A" key when prompted for the first digit will advance to the "Password Confirmed" screen.



Enter Password, first digit entered, prompt for second digit. (* Denotes that decimal point will be flashing).

Use the "V" key to scroll the value of the second digit from 0 through to 9, the value will wrap from 9 round to 0.

Press the "A" key to advance to next digit.

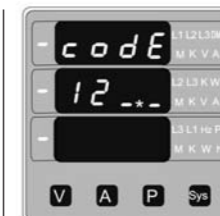

Enter Password, second digit entered, prompt for Third (* Denotes that decimal point will be flashing).

Use the "V" key to scroll the value of the third digit from 0 through to 9, the value will wrap from 9 round to 0.

Press the "A" key to advance to next digit.



Enter Password, third digit entered, prompt for Fourth digit. (* Denotes that decimal point will be flashing).

Use the "V" key to scroll the value of the fourth digit from 0 through to 9, the value will wrap from 9 round to 0.

Press the "A" key to advance to next digit.



Enter Password, fourth digit entered, awaiting verification of the password.

Pressing "A" key accepts the value of fourth digit and enters into password confirmation screen.



Password confirmation

Pressing "V" key will advance to the "New / change Password" entry stage.

Pressing the "A" key will advance to the menu Selection screen. (See section 3.2).



Password Incorrect

The unit has not accepted the Password entered.

Pressing the "V" key will return to the Enter Password stage.

Pressing the "A" key exits the Password menu and returns operation to the measurement reading mode.

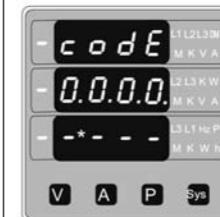

New / Change Password (* indicates that this decimal point will be flashing).

Pressing the "V" key will scroll the value of the first Digit from 0 through to 9, the value will wrap from 9 round to 0.

Pressing the "A" key to advance the operation to the Next digit and sets the second digit, in this case "6"

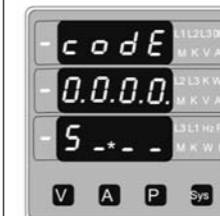

New / Change Password, first digit entered, prompting for second digit. (* indicates that this decimal point will be flashing).

Pressing the "V" key will scroll the value of second digit from 0 through to 9, the value will wrap from 9 round to 0.

Pressing the "A" key to advance the operation to the Next digit and sets the second digit, in this case "6"

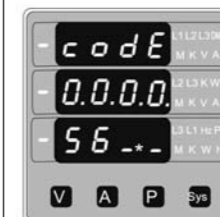

New / Change Password, second digit entered, prompting for third digit. (* indicates that this decimal Point will be flashing).

Pressing the "V" key will scroll the value of the third digit from 0 through to 9, the value will wrap from 9 round to 0.

Pressing the "A" key to advance the operation to the next digit and sets the third digit, in this case "7".



New / Change Password, third digit entered, prompting for fourth digit. (* indicates that decimal point will be flashing).

Pressing the "V" key will scroll the value of the fourth digit from 0 through to 9, the value will wrap from 9 round to 0.

Pressing the "A" key to advance the operation to the "New Password Confirmed" and sets the fourth digit, in this case "8".



New Password confirmed.

Pressing the "V" key will return back to the New/Change Password" screen.

Pressing "A" key will advance to the Set up Screen. (See section 3.2).

3.2 Set Up Screens

3.2.1. System Type



This screen is used to edit and set the system type. System type "3" for 3 phase 3 wire & "4" for 3 phase 4 wire & 1 for Single phase system.

Pressing "A" key accepts present value and advances to the "Potential transformer Primary Value Edit" menu. (See section 3.2.2)

Pressing "V" Key will enter the System type edit mode.



System Type Edit

This screen appears only if "V" key is pressed in previous Menu.

Pressing "V" scrolls through the values available.

Pressing "A" Key advances to the system type Confirmation menu.



System Type Confirmation

This screen will only appear following the edit of system type.

Pressing the "A" key set the displayed value as system Type and will advance to "Potential Transformer Primary Value Edit" menu. (See section 3.2.2)

3.2.2. Potential Transformer Primary Value

The nominal full scale voltage which will be set & displayed as the Line to Line voltage for all system types. This screen enables the user to display Line to Line and Line to neutral Voltages inclusive of any PT ratios, the values displayed represent the voltage in kilovolts (Note 'K' Annunciator).



Pressing the "A" key accepts the present value and advances to the "Current Transformer Primary value Edit" menu. (See Section 3.2.3)

Pressing the "V" key will enter the "Potential transformer Primary Value edit mode.

Initially the multiplier must be selected. pressing the "V" Key will move the decimal point position to the right side Until it reaches # # # .# after which it will return to #. # # # Pressing the "A" key accepts the present multiplier (Decimal Point position) and advances to the "Potential Transformer Primary Digit Edit" Screen.

Note : PT Values must be set as Line to Line Voltage for Primary as well as Secondary for all system types (3P3W/3P4W/1P2W).



Potential Transformer Primary Digit Edit

Pressing the "V" key will scroll the value of the most significant digit from 0 through to 9 unless the presently displayed Potential Transformer Primary value together with the Current Transformer Primary value previously Set, would result in a maximum power of greater than 1000 MVA per phase in that case the digit range will be Restricted.

Pressing the "A" key accepts the present value at the cursor position and advances the cursor to the next Less significant digit.

Note : the flashing decimal point indicates the cursor position, a steady decimal point will present the scaling of the number, until the cursor position coincides with the steady decimal point position. At this Stage the decimal point will be flashing.

When the least significant digit has been set, pressing the "A" key will advance to the "Potential transformer Primary Value Confirmation" stage. Screen showing display of 11.00 kVL-L i.e. 11000 Volts Line to Line indicating steady decimal point and cursor flashing at the "hundreds of volts" position as shown below.



Potential Transformer Primary Value Confirmation

This screen will only appear following an edit of the Potential Transformer Primary Value.

If the set value is to be corrected, pressing the "V" key will return back to "Potential Transformer Primary value Edit" stage

Pressing the "A" key sets the displayed value and will advance to the Current Transformer Primary Value Selection. (See section 3.2.3.)

3.2.3. Current Transformer Primary Value

The nominal Full Scale Current that will be displayed as the Line currents. This screen enables the user to display the nominal Line currents inclusive of any transformer ratios, the values displayed represent the Current in Amps.



Pressing the "V" key will enter the "Current Transformer Primary Value Edit" mode.

Pressing the "A" key will accept the present value And Advances to the "Potential Transformer Secondary Value edit screen (See section 3.2.4)



Current Transformer Ratio Edit

Pressing "V" key will advance the Most Significant Digit from 0 through to 9, unless the Current Transformer Primary Value together with the Potential Transformer Primary Value results in a maximum power of greater than 1000 MVA in which case the digit range will be restricted

Example: If primary value of PT is set as 692.8kVL-L (max value) then primary value of Current is restricted to 1736A.

Pressing the "A" key will advance to the next least significant digit. (* Denotes that decimal point will be flashing).

The "Maximum Power" restriction of 1000 MVA refers to 120% of nominal current and 120% of nominal voltage, i.e, 694.4 MVA nominal power per phase.

When the least significant digit is set, pressing the "A" key will advance to the "Current Transformer Primary Value Confirmation" stage.

The minimum value allowed is 1, the value will be forced to 1 if the display contains zero when "A" key is pressed.



Current Transformer Primary Value Confirmation.

This screen will only appear following an edit of the Current Transformer Primary Value, when "A" key is pressed after Setting the value of least significant Digit.

Pressing the "V" key will return back to CT primary edit Menu.

Pressing the "A" key sets the displayed value and then advance to the "Potential Transformer Secondary Value Edit" menu. (See section 3.2.4).

3.2.4. Potential Transformer Secondary Value



This screen is used to set the secondary value for Potential Transformer. Secondary value is set from 100VL-L to 500VL-L.

Pressing "A" key accepts the present value and then advances to Current Transformer Secondary value edit menu (section 3.2.5).

Pressing the "V" key will enter the PT secondary value edit mode. * Denotes that Decimal Point will be flashing.

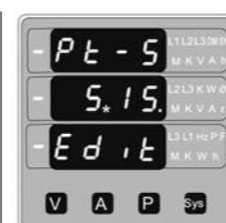

Potential Transformer secondary value Edit

Pressing "V" Key advances the Most Significant Digit To scroll from 1 through 5 .Pressing "A" shifts the Decimal Position to right.

When Value of least significant Digit is set, Pressing of "A" key advances the screen to "PT secondary value Confirmation" Screen.

Set the secondary value as per following ranges for better Accuracy Results :

Input Voltage Range (VL-L)	PT Secondary Range to be set (VL-L)
0 - 125 V	100V - 125 V
126V - 250 V	126V - 250 V
251V - 500 V	251V - 500 V



PT Secondary value confirmation

This screen will only appears following an edit of PT secondary value .

If secondary value shown is to be corrected, pressing "V" key will return back to PT secondary edit stage.

Pressing "A" key sets the displayed value and will advance to CT Secondary Value menu. (See section 3.2.5)

3.2.5. Current Transformer Secondary Value



This screen is used to set Current Transformer Secondary

The possible Values for CT Secondary are 1A and 5A. Value.

Pressing "A" key Accepts present Value and advances to RESET menu (section 3.2.6).

Pressing "V" key will enter the CT Secondary Edit menu.



Current Transformer Secondary Value Edit

Pressing "V" will Scroll Value between 1 and 5.

Pressing "A" will enter the CT Secondary Value Confirmation menu.



CT Secondary Value Confirmation

Pressing "V" will enter CT Secondary Value Edit Menu.

Pressing "A" will Accept present Value and Advances to RESET menu (section 3.2.6).

3.2.6. Resets

The following screens allow user to reset the run hrs, ON hrs, No. of Interruptions Min and Max. Values of Voltage and Current individually and all together.



Pressing the "V" key will enter the Reset edit mode.

Pressing the "A" key will Reset None and enter to Screen Auto or fixed selection menu.

Edit the Reset of Parameters

Pressing "V" will scroll the parameters in sequence as Follow :

1. All : To reset All parameters
2. Hi : To reset Max values
3. Lo : To reset min. Values
4. Hr : To reset Run Hrs, On Hrs
5. Int : To reset No. Of Interruptions
6. None : Not to reset any of the Parameters.

Select the desired parameter to Reset and then Press "A". This will enter to Reset Parameter Confirmation Screen.

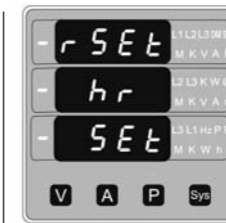

Confirmation of parameter for RESET

Pressing "V" will enter reset edit menu back and scroll between parameters as above.

Pressing "A" key will Reset the Selected Parameter. In this case hour parameters will get reset. Then it will enter to auto scrolling or fixed screen selection parameter.

3.2.7 Screen Auto scrolling / Fixed Screen selection

This menu allows user to select scrolling of parameters or fixed parameters Screen.



Auto Scrolling Edit

Pressing "A" selects the present selection and enters no. of poles selection menu (section 3.2.8).

Pressing of "V" enters to Edit menu.



Fixed Screen / Auto Scrolling Edit.

Pressing of "V" Rolls between "Yes" and "No".

Pressing "A" enters Auto scrolling / fixed screen Select confirmation.

Select "Yes" for auto scrolling and "No" for fixed screen.



Confirmation of Auto Scrolling / Fixed Screen

Pressing "V" enters back to screen edit menu.

Pressing "A" confirms the selection and enters Number of poles selection menu.

3.2.8 No. of Poles Selection

This screen enables to Set No. of poles of a Generator of which RPM is to be measured and to which the instrument is connected to monitor its parameters.



Selection of No. of poles of the Generator

Pressing "V" enters into no. of poles edit menu

Pressing "A" key will set the displayed number as No. of poles and enter into Relay limit parameter selection menu (section 3.2.9).



No. of poles edit

Pressing "V" scrolls the number from 02 to 40 in step of 2. After 40 it scrolls the number again to 02.

Pressing "A" enters into No. of poles Confirmation Screen.



No. of poles Confirmation

Pressing "V" enters back to No. of poles edit Menu.

Pressing "A" sets the number on screen, 4 in this Case, as number of poles of generator. Then it will enter into Relay limit parameter selection menu, and enter (section 3.2.9).

3.2.10 Relay Limit Parameter selection (Optional)

This screen enables user to select Parameter for limit monitoring via a Relay.



Selection of parameter

Pressing "A" key selects the displayed parameter
For monitoring and enters trip point selection Screen (section 3.2.11).
Pressing "V" key enters Trip parameter edit screen.



Trip parameter edit screen

Pressing "V" key scrolls the parameters one by one as per table 2. Selecting 00(None) disables relay function.
Pressing "A" selects the parameter and enters the Trip parameter confirmation screen.
In this case displayed number 11 will select VY-B For relay monitoring as per table 2.



Trip parameter confirmation screen.

This screen will appear only after parameter edit.
Pressing "A" will set the parameter for relay trip and
Pressing "V" will re-enter trip parameter edit menu then it will enter the trip point selection menu (Section 3.2.11).

TABLE 2 : Parameters for limit monitoring

Parameter No.	Measured Parameters	3P4W	3P3W	1P2W	Trip point Set range	100% Value
00	None	✓	✓	✓	—	—
01	Voltage	✓	×	✓	L1 10 - 120%	Vnom (L-N)
02	Voltage L2	✓	×	×	10 - 120%	Vnom (L-N)
03	Voltage L3	✓	×	×	10 - 120%	Vnom (L-N)
04	Current	✓	✓	✓	L1 10 - 120%	Inom
05	Frequency	✓	✓	×	10 - 120%	Inom
06	Voltage VL1-L2	✓	✓	×	10 - 100%	Inom
07	Current L2	✓	✓	✓	10 - 120%	66Hz ⁽¹⁾
10	Current L3	✓	✓	×	10 - 120%	Vn (L-L)
11	Voltage VL2-L3	✓	✓	×	10 - 120%	Vn (L-L)
12	Voltage VL3-L1	✓	✓	×	10 - 120%	Vn (L-L)
13	System Current	✓	✓	×	10 - 120%	Vnom ⁽²⁾
14	System Voltage	✓	✓	×	10 - 120%	Inom
24	Active Power L1	✓	×	✓	10 - 144%	Nom ⁽³⁾
25	Active Power L2	✓	×	×	10 - 144%	Nom ⁽³⁾
26	Active Power L3	✓	×	×	10 - 144%	Nom ⁽³⁾
27	Reactive Power L1	✓	×	✓	10 - 144%	Nom ⁽³⁾
28	Reactive Power L2	✓	×	×	10 - 144%	Nom ⁽³⁾
29	Reactive Power L3	✓	×	×	10 - 144%	Nom ⁽³⁾
30	Apparent Power L1	✓	×	✓	10 - 144%	Nom ⁽³⁾
31	Apparent Power L2	✓	×	×	10 - 144%	Nom ⁽³⁾
32	Apparent Power L3	✓	×	×	10 - 144%	Nom ⁽³⁾
39	Sum W (system W)	✓	✓	×	10 - 144%	Nom ⁽³⁾
40	Sum Var (System Var)	✓	✓	×	10 - 144%	Nom ⁽³⁾
41	Sum VA (System VA)	✓	✓	×	10 - 144%	Nom ⁽³⁾

Note : (1) For Frequency 0% corresponds to 45Hz and 100% corresponds to 66Hz.
(2) For 3P 4wire and 1ph the nominal value is V and that for 3P3W is V_{L-L}.
(3) Nominal value for power is calculated from nominal Voltage and current values.
(4) Nominal Value is to be considered with set CT/PT Primary values.
(5) For single phase L1 Phase values are to be considered as System values.

3.2.11 Trip point selection



This screen will not appear if parameter None (00) is Selected in previous menu.
Pressing "V" key will enter trip point edit screen.
Pressing "A" key will set displayed value as trip point and enters into Hysteresis selection menu (Section 3.2.12).



Trip point edit
* denotes that the decimal point will be flashing.
The 100s digit will scroll between 0 and 1, 10s digit will scroll from 1 to 9 if 100s digit is set to 0. If 100s digit is set to 1, the 10s digit will scroll from 0 to 2.
Thus, the trip point can be set as % of the Nominal value of selected parameter (Refer Table 2).



Select the desired trip point as displayed percentage of Set range of the parameter. After Setting LSD, pressing "A" key enters trip point confirmation screen.

Trip point Confirmation

Pressing "V" re-enters the trip point edit screen.

Pressing "A" selects the set trip point and enters into Hysteresis selection menu (section 3.2.12).

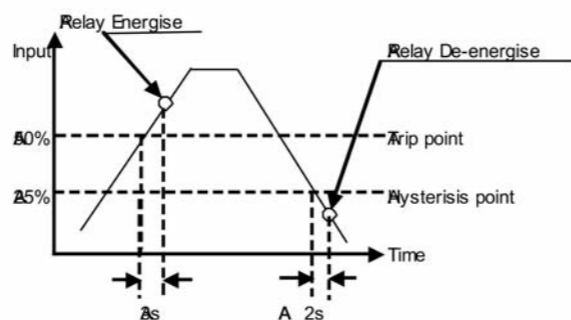

3.2.12 Relay Tripping (Energizing) Delay

Energizing delay can be set from 1 to 10seconds.



Pressing : "V" key enters into Energizing delay

Edit menu.

Pressing "A" key sets the displayed value as the delay in seconds and enters into De-energizing delay setting menu (section 3.2.14).



Energizing delay Edit

Pressing "V" key scrolls the display in increasing order upto 10sec and back to 01sec.

Pressing "A" key enters into Energizing delay confirmation screen.



Energizing delay confirmation

Pressing "V" key re-enters into edit screen above.

Pressing "A" key sets the displayed time in seconds. As a delay for Relay Energize and enter into De-Energizing delay setting menu (section 3.2.14).

3.2.14 Relay Resetting (De-Energizing) Delay

De-Energizing delay of relay can be set from 1 to 10seconds.



Pressing : "V" key enters into de-Energizing delay

Edit menu.

Pressing "A" key sets the displayed value as the delay in seconds and exits set up menu entering Measuring mode.



De-Energizing delay Edit

Pressing "V" key scrolls the display in increasing order up to 10sec and back to 01sec.

Pressing "A" key enters into de-Energizing delay confirmation screen.



De-Energizing delay confirmation

Pressing "V" key re-enters into edit screen above.

Pressing "A" key sets the displayed time in seconds as a delay for Relay de-Energize and exits set up Menu, and then enters into measurement mode.

4. Run Hours



This screen shows the total no. of hours the Load is connected. Even if the Auxiliary supply is interrupted, count of Run hour will be maintained in internal memory & displayed in the format "Hours.min". For example, if displayed count is 005678.56, then it indicates 5678 hours and 56 minutes.

After 999999.59 count of run hours, display will Start again from zero.

To reset run hour count manually, see section Reset (3.2.6).

5. ON Hours



This screen shows the total no. of hours the Auxiliary supply is ON. Even if the Auxiliary supply is interrupted, count of ON hour will be maintained in internal memory & displayed in the format "Hours.min". For example, if displayed count is 014678.23, then it indicates 14678 hours and 23 minutes.

After 999999.59 count of ON hours, display will Start again from zero.

To reset ON hour count manually, see section Reset (3.2.6).

6. Number of interruptions



This screen displays the total no. of times the auxiliary supply was interrupted. Even if the auxiliary Supply is interrupted, the count will be maintained in internal memory. To reset No. of interruptions count manually, see section Reset (3.2.6).

7. Negative sign indication

If the segment glows, it indicates negative sign of displayed parameter.



When Power factor lies in second and third quadrant, it has -ve sign, so active power has -ve sign as shown in the phaser diagram. Also in 3rd and 4th quadrant, reactive power is -ve. So the -ve annunciator glows to indicate the operation of system in respective mode as per the Phaser diagram shown on page 10. For example in the screen shown, Input values were 240V , 20A, and phase angle 1870 hence the phase L-N active power is displayed with -ve sign.

3.2.12 Hysteresis for Relay Reset



This screen appears after setting the trip point.

Pressing "V" enters into Hysteresis edit screen.

Pressing "A" sets displayed value as hysteresis and enters into Relay Energizing delay menu (Section 3.2.13)

Hysteresis for frequency is calculated as % of trip point span from 45Hz. e.g. If trip point is 50%(55.5Hz) and hysteresis is set to 10%, then relay will reset at Hence, 55.5 - 1.05 = 54.45Hz] 54.45Hz. [10% of (55.5 - 45 Hz) 10.5Hz is 1.05Hz

Hysteresis Limit Edit

Hysteresis can be set from 10% to 50% of trip point.

Pressing "V" key scrolls the value of 10s digit. * denotes cursor position. (the decimal point will be Flashing). Pressing "V" scrolls the value of digit at Curser position.

After setting value of 10s digit pressing "A" key shifts the cursor to LSD. After setting the Value of LSD, pressing "A" key enters into hysteresis limit confirmation screen.



Hysteresis limit confirmation

Pressing "V" key re-enter into Hysteresis limit edit Screen.

Pressing "A" key sets the displayed value for relay Reset hysteresis and enters into Relay energizing delay setting menu (section 3.2.13).

8. Installation

Mounting of Delta is featured with easy "Clip-in" mounting. Push the meter in panel slot (size 92 x92 mm), it will click fit into panel with the four integral retention clips on two sides of meter.

If required Additional support is provided with swivel screws (optional) as shown in figure.

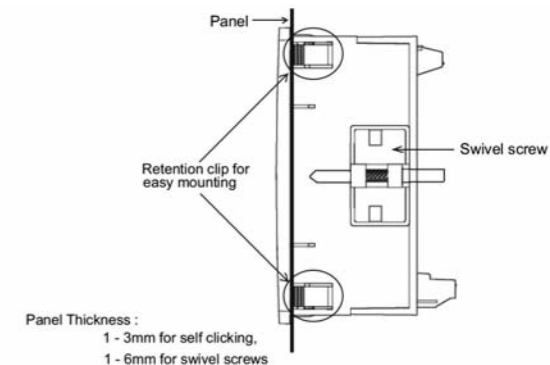

The front of the enclosure conforms to IP50. Additional protection to the panel may be obtained by the use of an optional panel gasket. The terminals at the rear of the product should be protected from liquids.

The RS Pro should be mounted in a reasonably stable ambient temperature and where the operating temperature is within the range 0 0 to 50 C . Vibration should be kept to a minimum and the product should not be mounted where it will be subjected to excessive direct sunlight.

Caution

- In the interest of safety and functionality this product must be installed by a qualified engineer, abiding by any local regulations.
- Voltages dangerous to human life are present at some of the terminal connections of this unit. Ensure that all supplies are de-energized before attempting any connection or disconnection.
- These products do not have internal fuses therefore external fuses must be used to ensure safety under fault conditions.

8.1 EMC Installation Requirements

This product has been designed to meet the certification of the EU directives when installed to a good code of practice for EMC in industrial environments,

e.g.

Screened output and low signal input leads or have provision for fitting RF suppression components, such as ferrite absorbers, line filters etc., in the event that RF fields cause problems.

Note: It is good practice to install sensitive electronic instruments that are critical functions, in EMC enclosures that protect against electrical performing interference which could cause a disturbance in function.

Avoid routing leads alongside cables and products that are, or could be, a source of interference.

To protect the product against permanent damage, surge transients must be limited to 2kV pk. It is good EMC practice to suppress differential surges to 2kV at source. The unit has been designed to automatically recover in the event of a high level of transients. In extreme circumstances it may be necessary to temporarily disconnect The auxiliary supply for a period of greater than 5 seconds to restore correct operation.

The Current inputs of these products are designed for connection in to systems via Current Transformers only, where one side is grounded. ESD precautions must be taken at all times when handling this product.

8.2 Case Dimension and Panel Cut Out

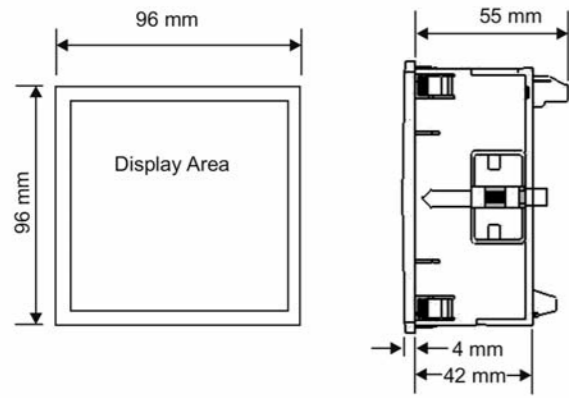

With optional Limit switch.

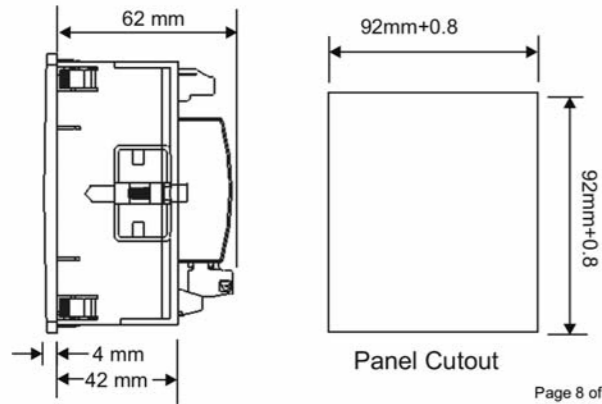

Page 8 of 11

8.4 Auxiliary Supply

RS Pro should ideally be powered from a dedicated supply, however powered from the signal source, provided the source remains within it may be the limits of the Chosen auxiliary voltage range.

8.5 Fusing

It is recommended that all voltage lines are fitted with 1 amp HRC fuse.

8.6 Earth/Ground Connections

For safety reasons, CT secondary connections should be grounded in accordance with local regulations.

9 Connection Diagram

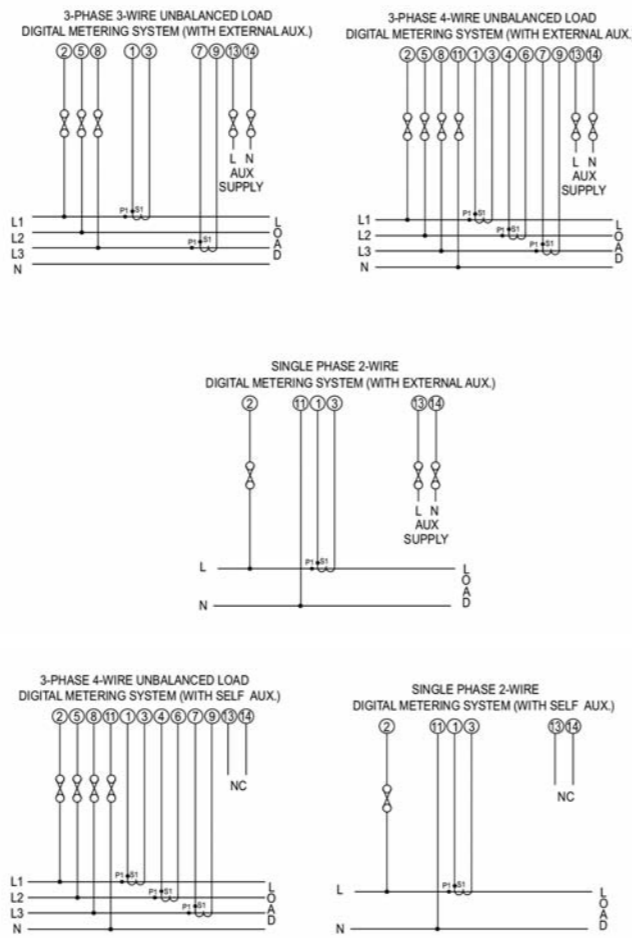
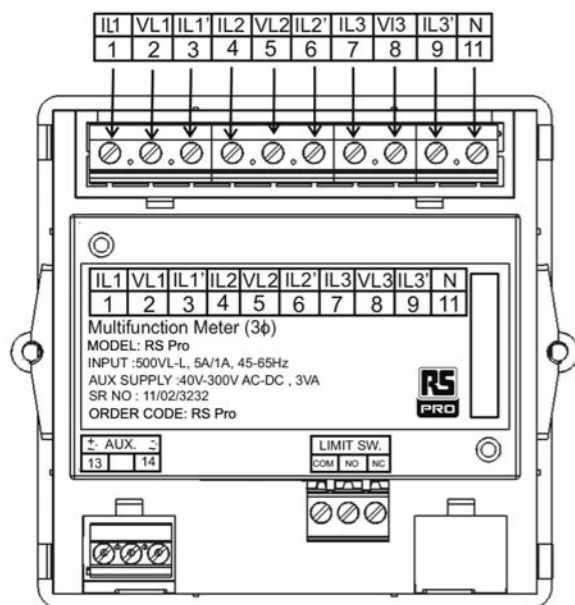

10. Optional Pluggable Module

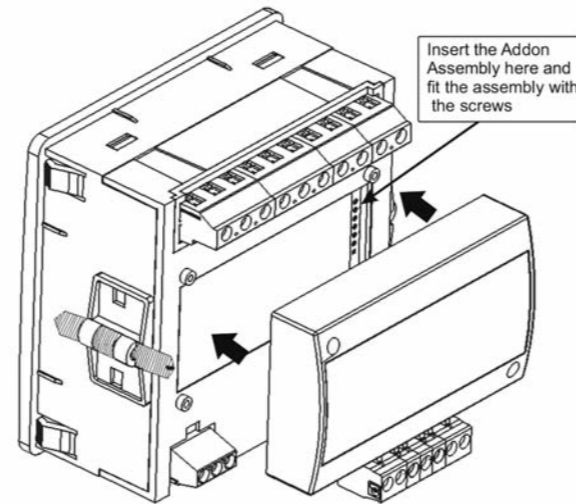

Optional Limit Switch pluggable module.

11. Phaser Diagram for sign convention of power :

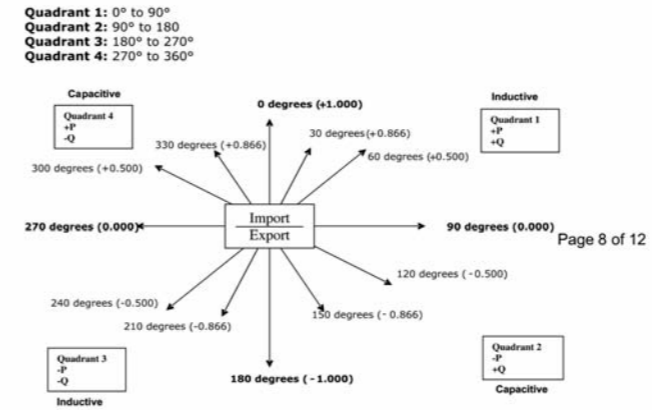

12. Limit Switch

Limit switch can be used to monitor the measured parameter (Ref. Table 2) in relation with to a set limit.

The limit switch can be configured for **Hi alarm & Relay Energized Relay** with user selectable Trip point, Hysteresis, Energizing Delay & De-Energizing delay.

Trip point: Trip point can be set in the range as specified in table 2 of nominal value for Hi-Alarm.

Hysteresis: Hysteresis can be set in the range of 10% to 50% of set trip point. If Ho-alarm Energized or Hi-alarm De-energized is selected then relay will get De-energized or Energized respectively, if set parameter value is less than Hysteresis

Energizing Delay: The energizing delay can be set in the range from 1 to 10 sec.

De-Energizing Delay: The De-energizing delay can be set in the range from 1 to 10 sec.

Example of Limit Switch configuration.

Parameter No: 4 (Current 1)

Trip Point = 50%

Hysteresis = 50% of trip point

Energizing Delay: 2s

De-energizing Delay: 2s

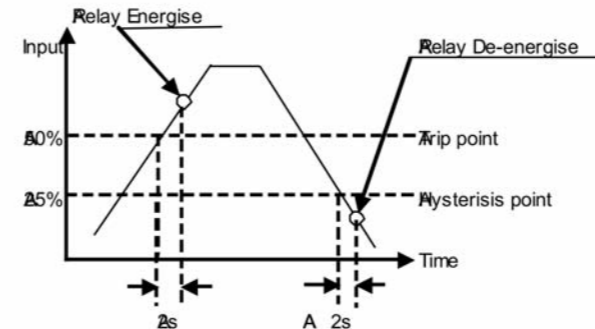

13. Specifications

System

3 Phase 3 Wire / 4 Wire or Single Phase programmable at site

Inputs

Nominal Input Voltage 500 V_{L-L} (290V_{L-N}) AC RMS
System PT Primary Values 100V_{L-L} to 692 kV_{L-L}, programmable at site
System PT Secondary Values 100V_{L-L} to 500 V_{L-L}, programmable at site
Max continuous input voltage 120% of Rated Value
Nominal input voltage burden 0.3VA approx. per Phase (for ext. Aux. Meter)

Nominal Input Current

5A AC RMS
Max continuous input current 120% of Rated Value
Nominal input current burden <0.2VA approx. per phase
System CT primary values Std. Values 1 to 9999A (1 or 5 Amp secondary)
System Secondary Values 1A / 5A, programmable at site

Overload withstand

Voltage input 2 x Rated Value
(1s application repeated 10 times at 10s intervals)
Current input 20 x Rated Value (1s application repeated 5 times at 5 min. intervals)

Auxiliary Supply

Auxiliary Supply 40V to 300V AC/DC (+/- 5%)
DC Auxiliary Supply 12V-48V DC
Self Powered Input Voltage Range from 80% to 100% of rated value (Self Powered meter is available only in 3 Phase 4W and 1 phase network. Aux input is derived from L1 phase)
Frequency Range 45 to 65 Hz
VA Burden 3 VA Approx.
DC Burden 3W Approx.

Operating Measuring Ranges

Voltage with external Aux. 10 ... 120 % of Rated Value
Voltage with Self Aux. 80 ... 120% of Rated Value
Current 10 ... 120 % of Rated Value
Frequency 45 .. 65 Hz

Reference conditions for Accuracy :

Reference temperature 23°C + 2°C
Input frequency 50 or 60Hz + 2%
Input waveform Sinusoidal (distortion factor 0.005)
Auxiliary supply voltage Rated Value + 1 %
Auxiliary supply frequency Rated Value + 1 %
Power factor cosφ=1 for active power / sinφ=1 for reactive power

Accuracy

Voltage + 1.0 % of range (20 ... 100% of Nominal Value)
Current + 1.0 % of range (10 ... 100% of Nominal Value)
Frequency + 0.5% of mid frequency
Active power + 1.0 % of range (10 ... 100% of Nominal Value)
Reactive power + 1.0 % of range (10 ... 100% of Nominal Value)
Apparent Power + 1.0 % of range (10 ... 100% of Nominal Value)
Power factor + 2.0 % of unity (50 ... 100% of Nominal Value)
Phase angle + 2.0 % of range (50 ... 100% of Nominal Value)

Relay

Settable parameters as per table 2
Trip Point setting as per table 2
Hysteresis 10% to 50% of trip point, settable
Relay energizing delay 1 to 10sec, settable
Relay de-energizing delay 1 to 10sec, settable
Contact type single pole NO + NC, volt free contacts
Contact rating 250V, 5A

Influence of variations

Temperature Coefficient 0.05% / C for Current (10..120% of Rated Value)
(For Rated value range of use 0... 5°C) 0 0.025% / C for Voltage (10..120% of Rated Value)
Error change due to variation of an influence quantity 2 * Error allowed for the reference condition applied in the test.

Display

LED 3 line 4 digits, Display height : 14mm
Annunciation of units Bright LED s from Back side of screen
Update rate Approx. 1 seconds

Controls

User Interface 4 Keys

Standards

EMC Immunity IEC 61326-1 : 2005
EMC Emission IEC 61326-1 : 2005
Safety IEC 61010-1-2001, permanently connected use
IP for water & dust IEC 60529

Safety

Pollution degree 2
Installation category III

Isolation

Dielectric voltage withstands 3.3 kV RMS 50 Hz for 1 minute
test between circuits and accessible surfaces
Between all electrical circuits

Environmental conditions

Operating temperature 0 to 50°C
Storage temperature -25 to +70°C
Relative humidity 0 ... 90 % RH (Non condensing)
Warm up time 3 minute (minimum)
Shock 15g in 3 planes
Vibration 10 .. 55 Hz, 0.15mm amplitude

Enclosure

Enclosure front IP 50
Enclosure front with seal (optional) IP 65
Enclosure back IP 20

Dimensions

Bezel Size 96mm x 96mm DIN 43718
Panel cut out 92^{+0.8} mm X 92^{+0.8} mm
Overall Depth 55 mm

Panel thickness 1 - 3mm for self clicking
1 - 6mm for swivel screws
Weight 320 grams Approx.

Article codes

Article No: 136-5381

RS Pro 3 Line display Volts, Amp Frequency and Power, 96x96mm, 3 Phase 3/4W programmable onsite,
AC VAF + Power meter, 14mm display,
Input. 100-500VLL,
Input. 1 or 5 Amps AC,
Supply Voltage. 40-300V AC/DC auxiliary (Programmable CT/PT primary and secondary values)

Article No: 136-5382

RS Pro 3 Line display Volts, Amp Frequency and Power, 96x96mm, 3 Phase 3/4W programmable onsite,
AC VAF + Power meter, 14mm display,
Input. 100-500VLL,
Input. 1 or 5 Amps AC,
Supply Voltage. 40-300V AC/DC auxiliary (Programmable CT/PT primary and secondary values with Limit Switch/Relay O/P)

14. Connection for Optional Relay Output / RS 485

(rear view of RS Pro) :

1. Relay Output



The Information contained in these installation instructions is for use only by installers trained to make electrical power installations and is intended to describe the correct method of installation for this product. However, Company has no control over the field conditions which influence product installation.

It is the user's responsibility to determine the suitability of the installation method in the user's field conditions. Company only obligations are those in Company standard Conditions of Sale for this product and in no case will Company be liable for any other incidental, indirect or consequential damages arising from the use or misuse of the products.

FOR MORE INFORMATION VISIT THIS SITE
<http://www.rs-components.com/index.html>