



## Main

Range of product	Zelio Relay
Series name	Interface relay
Product or component type	Plug-in relay
Device short name	RXG
Contacts type and composition	2 C/O

## Complementary

Status LED	Without
Contacts material	Silver alloy (AgSnO <sub>2</sub> In <sub>2</sub> O <sub>3</sub> )
Maximum contact resistance	100 mOhm
[I <sub>th</sub> e] conventional enclosed thermal current	5 A
[I <sub>e</sub> ] rated operational current	5 A at 30 V (DC) conforming to UL 5 A at 30 V (DC) conforming to IEC 5 A at 250 V (AC) conforming to IEC 5 A at 250 V (AC) conforming to UL
Maximum switching voltage	250 V
Load current	5 A
Maximum switching capacity	1250 VA AC 150 W DC
Minimum switching capacity	50 mW at 10 mA, 5 V DC
Operating rate	<= 1800 cycles/hour under load <= 18000 cycles/hour no-load
Utilisation coefficient	20 %
Mechanical durability	10000000 cycles
Electrical durability	100000 cycles resistive load
[U <sub>i</sub> ] rated insulation voltage	250 V conforming to IEC
[U <sub>imp</sub> ] rated impulse withstand voltage	6 kV 1.2/50 µs between coil and contact 4 kV 1.2/50 µs between poles 1.2 kV 1.2/50 µs between contacts 2.5 kV 1.2/50 µs between terminals and LTB area 1.5 kV 1.2/50 µs between terminals and base
Dielectric strength	1000 V AC between contacts with micro disconnection 1300 V between terminals and base with basic insulation 3000 V between terminals and LTB area with basic insulation 3000 V AC between poles with basic insulation 5000 V AC between coil and contact with reinforced insulation
Coil resistance	23500 Ohm +/- 15 %
Insulation resistance	1000 MOhm at 500 V DC
Test levels	Level A group mounting
Mounting position	Any position
Average coil consumption	0.96 VA AC 50...60 Hz
Drop-out voltage threshold	>= 0.3 U <sub>c</sub> AC
Coil insulation class	Class F
Operate time	20 ms

Release time	20 ms
[Uc] control circuit voltage	230 V AC
Safety reliability data	B10d = 100000
Colour of cover	Transparent
Control type	Lockable test button
Torque value	0.8 N.M 0.79 N.m
Connections - terminals	Connector, 1 x 0.25...1 x 2.5 mm <sup>2</sup> (AWG 22...AWG 14) flexible with cable end Connector, 2 x 0.25...2 x 1 mm <sup>2</sup> (AWG 22...AWG 17) flexible with cable end Connector, 1 x 0.5...1 x 2.5 mm <sup>2</sup> (AWG 20...AWG 14) solid without cable end Connector, 2 x 0.5...2 x 1.5 mm <sup>2</sup> (AWG 20...AWG 16) solid without cable end
Net weight	0.065 kg
Device presentation	Complete product





## Environment

Vibration resistance	3 gn, amplitude = +/- 1.5 mm (f = 10...150 Hz)in operation 5 gn, amplitude = +/- 1.5 mm (f = 10...150 Hz)not in operation
IP degree of protection	IP20
Shock resistance	20 gn in operation 100 gn not in operation
Protection category	RT I
Standards	IEC 61810-1 CSA C22.2 No 14 UL 508 IEC 61984
Product certifications	EAC REACH RoHS CSA UL CE China RoHS
Pollution degree	2
Overvoltage category	III
Ambient air temperature for storage	-40...85 °C
Ambient air temperature for operation	-40...70 °C
Relative humidity	10...85 %

## Packing Units

Package 1 Weight	67.000 g
Package 1 Height	79.600 mm
Package 1 width	15.600 mm
Package 1 Length	72.000 mm

## Offer Sustainability

Sustainable offer status	Green Premium product
REACH free of SVHC	Yes
EU RoHS Directive	Pro-active compliance (Product out of EU RoHS legal scope)  <a href="#">EU RoHS Declaration</a>
Toxic heavy metal free	Yes
Mercury free	Yes
RoHS exemption information	 Yes
China RoHS Regulation	 <a href="#">China RoHS Declaration</a>
Environmental Disclosure	 <a href="#">Product Environmental Profile</a>
WEEE	The product must be disposed on European Union markets following specific waste collection and never end up in rubbish bins

## Contractual warranty

Warranty	18 months
----------	-----------

Dimensions

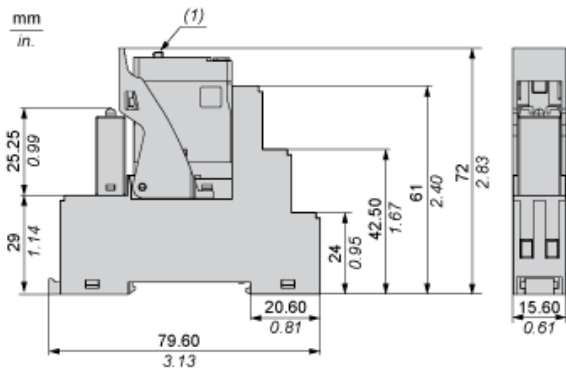

(1) Push button (if any)

## Wiring Diagram

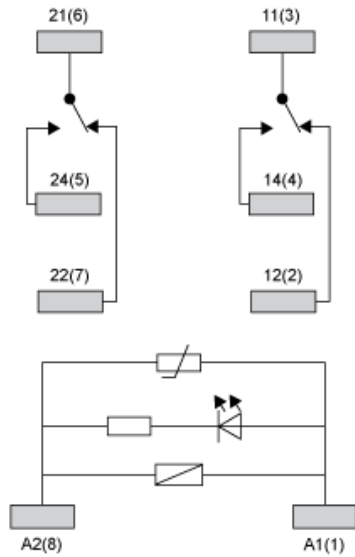

Performance Curves

Maximum Switching Capacity

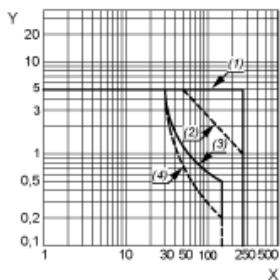

- X : Switching voltage (V)
- Y : Switching current (A)
- (1) AC Resistive Load
- (2) AC Inductive Load  $\cos(\phi)=0.4$
- (3) DC Resistive Load
- (4) DC Inductive Load (L/R=7ms)

Life Expectancy

Resistive Load

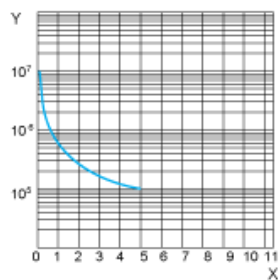

- X : Contact Current (A)
- Y : Operating Cycle Number

Life Expectancy

Inductive Load

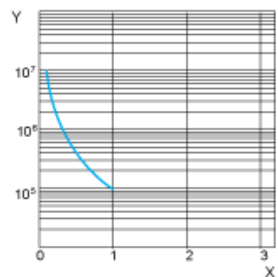

- X : Contact Current (A)
- Y : Operating Cycle Number

NOTE: These are typical curves, actual durability depends on load, environment, duty cycle, etc.

Coil Operating Range

## AC Coil Operating Range VS Ambient Temperature



- X : Ambient temperature (°C)
- Y : Coil voltage (U/Uc)
- (1) Permitted operating range area