



Brand of NTN Group

Technical data

UCF206-20

Bearing units



Grey cast housing, radial insert ball bearing with socket set screws, seal with slinger

KIT CONTENT

UC206-20G2, F206

VISUAL (S)

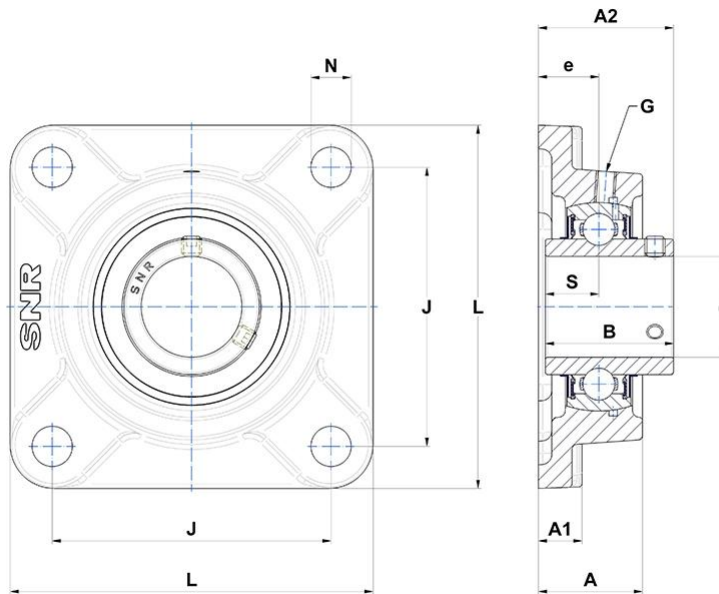

PRODUCT DEFINITION

Brand	SNR
A - Housing height	31 mm
A1 - Housing foot height / flange height	13 mm
A2 - Total height from mounting surface	40,2 mm
B - Width of Inner Ring	38,1 mm
d - Shaft diameter	31,75 mm



NTN Europe

1 rue des Usines · BP 2017 · 74010 Annecy Cedex · France · Tel. +33 (0)4 50 65 30 00
 S.A. au capital de 322 639 919 € · RCS ANNECY B 325 821 072 · Id. Fiscale : FR 48 325 821 072
 SIRET 325 821 072 00015 · Code APE 2815 Z · Code NACE 28.15

PRODUCT DEFINITION

e - Distance mounting surface to bearing center	18 mm
G - Grease fitting	M6x1
J - Mounting holes distance	83 mm
L - Housing width / diameter	108 mm
N - Mounting hole dimension	12 mm
S - Distance front side/bearing centre	15,9 mm

PRODUCT PERFORMANCE

C - Dynamic load rating	19500000 mN
C0 - Static load rating	11200000 mN
Operating temperature min.	253,15 °K
Operating temperature max.	373,15 °K

OTHER FEATURES

Mass	1,09 kg
Recommended tightening torque for set screw	3.7 N-m

