

MARKING:

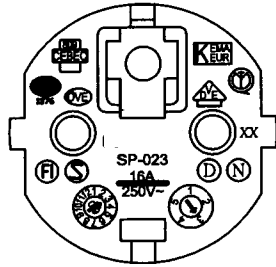

MARKING:

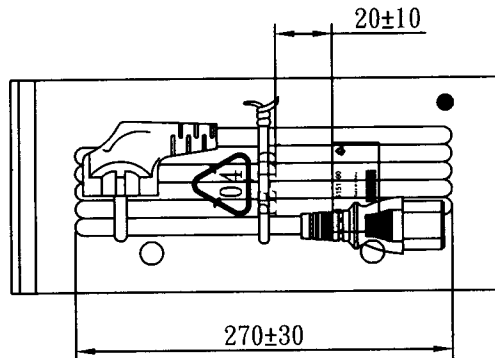
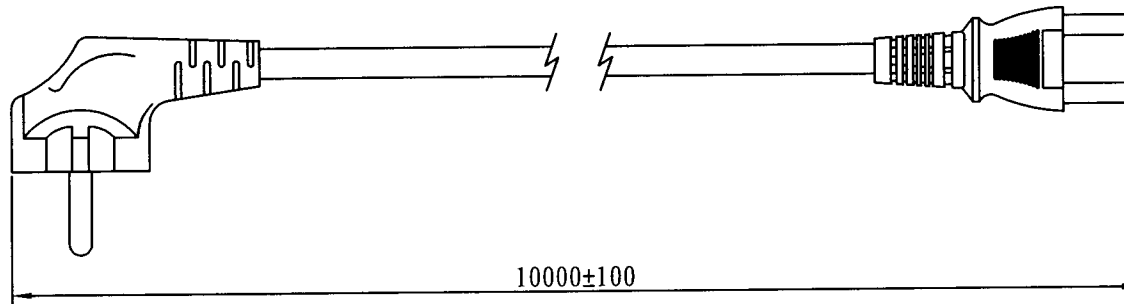
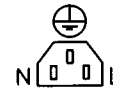
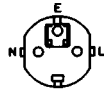
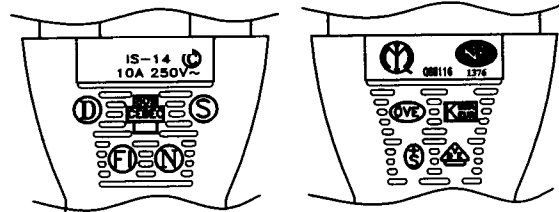

WIRING COLOR:

E: Yellow/Green
N: Blue
L: Brown

LENGED ON CORD: (206-14)

SGIS <VDE> KEMA-KEUR <VE> CE BEC 809
NF-USE 1346 IEMMEQU H05VV-F 3G 1.5mm² 60227 IEC 53 RVV 300/500V
A003083 3ASL/150 4V-75 V-75 (75°C) 250/440V ORDINARY DUTY Q96257 -LF- CE

No	BOM ITEM	Q' TY	P/N
1	SP-023 INSERT(BLACK)	1 PCS	MB023012
2	PVC 45P (SA87, SP-023)	45 g	RPP04512
3	KPR-14 TERMINAL	3 pcs	BBB14000
4	IS-14 INNER BODY	1 set	MI014000
5	PVC 45P (SA87, IS-14)	22 g	RPP04512
6	PE TIE (BLACK, 12 inch)	1 pcs	KBB10012
7	PE BAG(370*200*0.06)	1 pcs	KPR1100R
8	LABLE	1 pcs	

NOTE : 1. CORD : EAN-128C

2 : SCAN CONTENT : 6151160

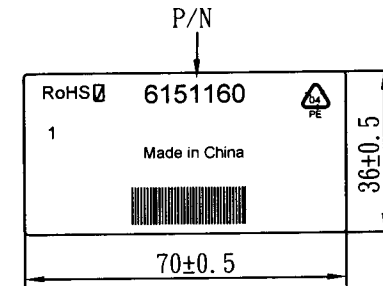

CABLE	H05VV-F 3G 1.5 DENT PRINT CT-12 (BLACK)			
PLUG	SP-023 + IS-14	LENGTH	10000	UNIT mm
CLIENT	NAME	First Connectivity	N/W	1.227895
	P/N	6151160	SG DWG	SR-142461-2
			Design. by	楊望春
			Review. by	
			Approval. by	15/10/2012
Y34 6E3016 12 10M 01				