



Brand of NTN Group

Technical data

UCF215-48

Bearing units



Grey cast housing, radial insert ball bearing with socket set screws, seal with slinger

KIT CONTENT

UC215-48G2, F215

VISUAL (S)

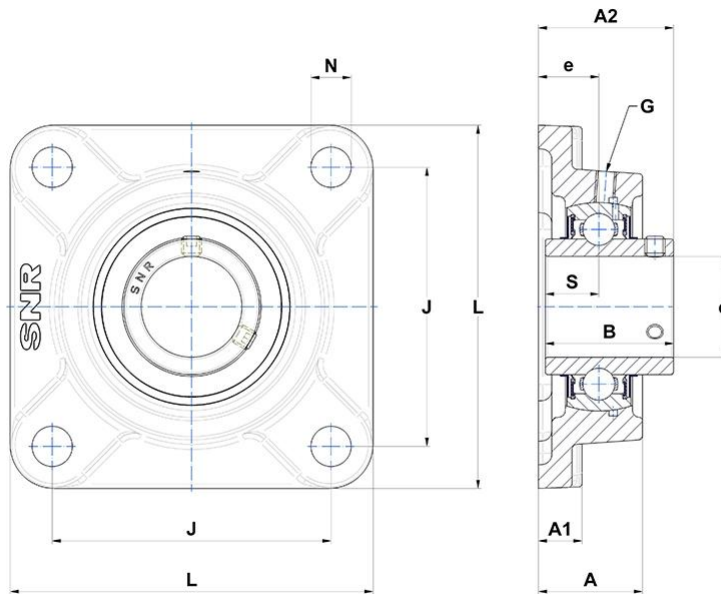

PRODUCT DEFINITION

Brand	SNR
A - Housing height	56 mm
A1 - Housing foot height / flange height	22 mm
A2 - Total height from mounting surface	78,5 mm
B - Width of Inner Ring	77,8 mm
d - Shaft diameter	76,2 mm



NTN Europe

1 rue des Usines · BP 2017 · 74010 Annecy Cedex · France · Tel. +33 (0)4 50 65 30 00
 S.A. au capital de 322 639 919 € · RCS ANNECY B 325 821 072 · Id. Fiscale : FR 48 325 821 072
 SIRET 325 821 072 00015 · Code APE 2815 Z · Code NACE 28.15

PRODUCT DEFINITION

e - Distance mounting surface to bearing center	34 mm
G - Grease fitting	M10x1
J - Mounting holes distance	159 mm
L - Housing width / diameter	200 mm
N - Mounting hole dimension	19 mm
S - Distance front side/bearing centre	33,3 mm

PRODUCT PERFORMANCE

C - Dynamic load rating	66000000 mN
C0 - Static load rating	49500000 mN
Operating temperature min.	253,15 °K
Operating temperature max.	373,15 °K

OTHER FEATURES

Mass	5,66 kg
Recommended tightening torque for set screw	27.1 N-m

