

Surface-mounting, 1-GHz-Band, Miniature, DPDT, High-frequency Relay

- ROHS compliant.
- Superior high-frequency characteristics (at 1 GHz), such as an isolation of 20 dB min. between contacts of the same polarity or 30 dB min. between contacts of different polarity with an insertion loss of 0.2 dB max.
- Miniaturized to 10.3 x 6.9 x 5.4 mm (L x W x H).
- Rated power consumption of 100 mW with high sensitivity.
- Single-side stable and single-winding latching models available.
- Models with a smaller footprint (G6K(U)-2F-RF(-S)) are available for space saving.

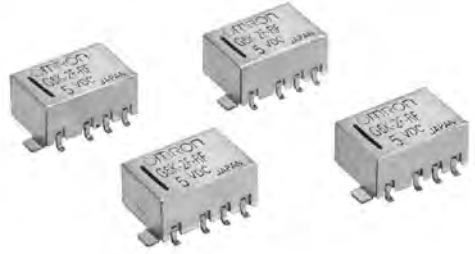

Ordering Information

Model Number Legend

G6K

1 2 3 4 5

1. Relay Function

- None: Single-side stable
- U: Single-winding latching

2. Classification

- 2: DPDT

3. Terminal Shape

- F: Surface-mounting terminals

4. Special Function

- RF: High-frequency compatible

5. Ground Terminal Shape

- None: Standard
- S: Small footprint

■ List of Models

Standard Models with Surface-mounting Terminals

| Classification | Structure | Contact form | Rated coil voltage | Model | Minimum Package Quantity (see note): |
|-------------------------|----------------|--------------|---------------------------|-----------------|--------------------------------------|
| Single-side stable | Plastic sealed | DPDT | 3, 4.5, 5, 12, and 24 VDC | G6K-2F-RF (-S) | 300 units/tray |
| Single-winding latching | | | 3, 4.5, 5, 12, and 24 VDC | G6KU-2F-RF (-S) | 300 units/reel |

Note: When ordering relays in tape packing, add "-TR09" to the end of the model number. If "-TR" is not added, the relays will be provided in tray packing.

Relays per reel: 300 for "-TR03"
900 for "-TR09"

This specification, however, is not part of the relay model number, so it is not marked on the relay case.

Application Examples

- Measurement devices
- Communications devices
- Broadcasting and audio-visual devices
- Medical equipment

Specifications

■ Contact Ratings

| | |
|------------------------|---|
| Load | Resistive load |
| Rated load | 125 VAC, 0.3 A 30 VDC, 1 A 1 GHz, 1 W (see note.) |
| Contact Material | Au |
| Rated carry current | 1 A |
| Max. switching voltage | 125 VAC or 60 VDC |
| Max. switching current | 1 A |

Note: This value is for V.SWR of 1.2 max. at the load.

■ High-frequency Characteristics

| Item | Frequency | 1 GHz |
|-------------------------|--|-------------------|
| Isolation | Between contacts of the same polarity | 20 dB min. |
| | Between contacts of different polarity | 30 dB min. |
| Insertion loss | | 0.2 dB max. |
| V.SWR | | 1.2 max. |
| Maximum carry power | | 3 W (See note 3.) |
| Maximum switching power | | 1 W (See note 3.) |

- Note:
1. The impedance of the measurement system is 50 Ω.
 2. The above values are initial values.
 3. Contact your Omron representative if the relay will be used in applications that require high repeatability with high-frequency characteristics in microload regions.
 4. These values are for a V.SWR of 1.2 max. at the load.

■ Characteristics

| Item | Single-side stable models | Single-winding latching models |
|-------------------------------------|---|--------------------------------|
| | G6K-2F-RF(-S) | G6KU-2F-RF(-S) |
| Contact resistance (See note 2.) | 100 mΩ max. | |
| Operating (set) time (See note 3.) | 3 ms max. (approx. 1.4 ms) | 3 ms max. (approx. 1.2 ms) |
| Release (reset) time (See note 3.) | 3 ms max. (approx. 1.3 ms) | 3 ms max. (approx. 1.2 ms) |
| Minimum set/reset pulse time | --- | 10 ms |
| Insulation resistance (See note 4.) | 1,000 MΩ min. (at 500 VDC) | |
| Dielectric strength | Between coil and contacts | 750 VAC, 50/60 Hz for 1 min |
| | Between contacts of different polarity | 750 VAC, 50/60 Hz for 1 min |
| | Between contacts of the same polarity | 750 VAC, 50/60 Hz for 1 min |
| | Between ground and coil/contacts | 500 VAC, 50/60 Hz for 1 min |
| Vibration resistance | Destruction: 10 to 55 to 10 Hz, 2.5-mm single amplitude (5-mm double amplitude) and 55 to 500 to 55 Hz, 300 m/s ² Malfunction: 10 to 55 to 10 Hz, 1.65-mm single amplitude (3.3-mm double amplitude) and 55 to 500 to 55 Hz, 200 m/s ² | |
| Shock resistance | Destruction: 1,000 m/s ² Malfunction: 750 m/s ² | |
| Endurance | Mechanical: 50,000,000 operations min. (at a switching frequency of 36,000 operations/hour) Electrical: 100,000 operations min. (at a switching frequency of 1,800 operations/hour) | |
| Ambient temperature | Operating: -40°C to 70°C (with no icing or condensation) | |
| Ambient humidity | Operating: 5% to 85% | |
| Weight | Approx. 0.95 g | |

- Note:
1. The above values are initial values.
 2. The contact resistance was measured with 10 mA at 1 VDC with a voltage drop method.
 3. Values in parentheses are actual values.
 4. The insulation resistance was measured with a 500-VDC megohmmeter applied to the same parts as those used for checking the dielectric strength.

■ Coil Ratings

Single-side Stable Models

G6K-2F-RF(-S)

| Rated voltage (VDC) | 3 | 4.5 | 5 | 12 | 24 |
|--------------------------|---------------------------|------|------|-------|-------|
| Rated current (mA) | 33.0 | 23.2 | 21.1 | 9.1 | 4.6 |
| Coil resistance (Ω) | 91 | 194 | 237 | 1,315 | 5,220 |
| Must operate voltage (V) | 80% max. of rated voltage | | | | |
| Must release voltage (V) | 10% min. of rated voltage | | | | |
| Maximum voltage (V) | 150% of rated voltage | | | | |
| Power consumption (mW) | Approx. 100 mW | | | | |

Single-winding Latching Models

G6KU-2F-RF(-S)

| Rated voltage (VDC) | 3 | 4.5 | 5 | 12 | 24 |
|--------------------------|---------------------------|------|------|-------|-------|
| Rated current (mA) | 33.0 | 23.2 | 21.1 | 9.1 | 4.6 |
| Coil resistance (Ω) | 91 | 194 | 237 | 1,315 | 5,220 |
| Must operate voltage (V) | 75% max. of rated voltage | | | | |
| Must release voltage (V) | 75% max. of rated voltage | | | | |
| Maximum voltage (V) | 150% of rated voltage | | | | |
| Power consumption (mW) | Approx. 100 mW | | | | |

- Note:
1. The rated current and coil resistance are measured at a coil temperature of 23°C with a tolerance of ±10%.
 2. The operating characteristics are measured at a coil temperature of 23°C.
 3. The maximum voltage is the highest voltage that can be imposed on the Relay coil instantaneously.

Engineering Data

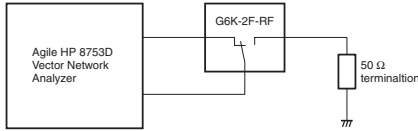

High-frequency Characteristics (Isolation)
(See notes 1 and 2.)

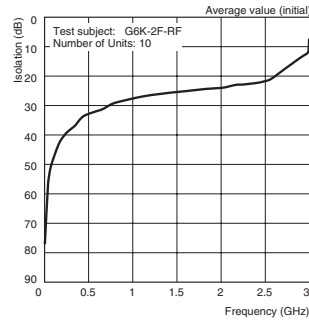

High-frequency Characteristics (Insertion Loss)
(See notes 1 and 2.)

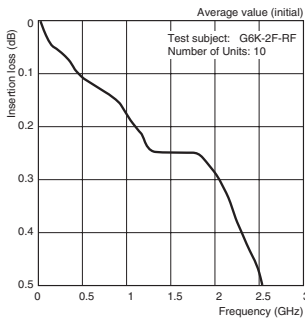

High-frequency Characteristics (Return Loss V.S.WR)
(See notes 1 and 2.)

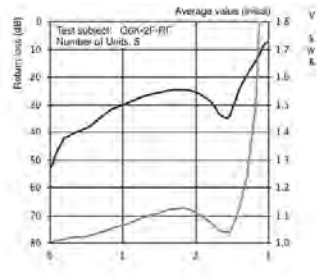
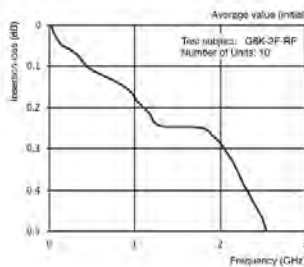
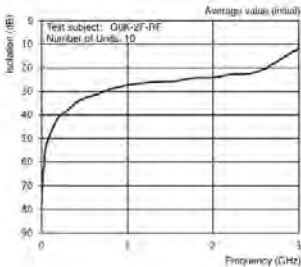
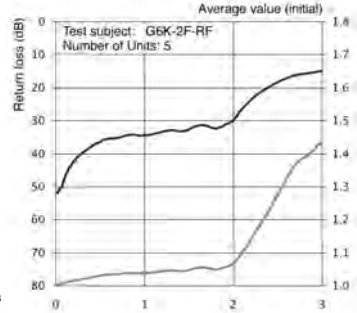

Note: Refer to the G6K specifications for basic specifications not shown above.

Note: 1. These tests were conducted at an ambient temperature of 23°C.

2. Ambient temperature condition: 23°C

3. High-frequency characteristics depend on the PCB to which the Relay is mounted. Always check these characteristics, including endurance, in the actual machine before use.

Dimensions

Note: All units are in millimetres unless otherwise indicated.

G6K-2F-RF G6KU-2F-RF

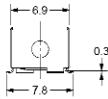
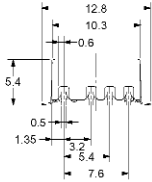
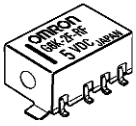

Mounting Dimensions (Top View)

Tolerance: ± 0.1 mm

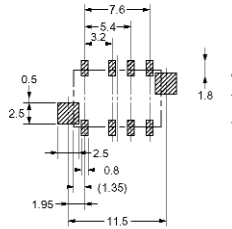

- Note: 1. Each value has a tolerance of ± 0.3 mm.
2. The coplanarity of the terminals is 0.15 mm max.

Terminal Arrangement/Internal Connections (Top View)

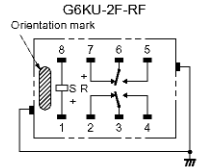
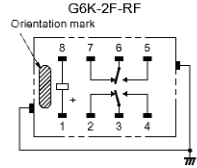

G6K-2F-RF-S G6KU-2F-RF-S

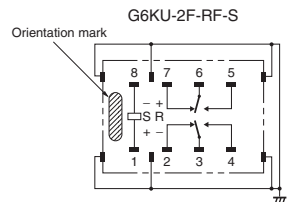
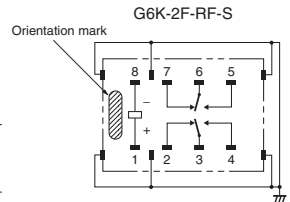
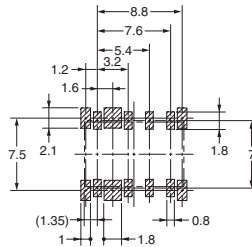
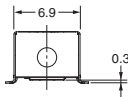
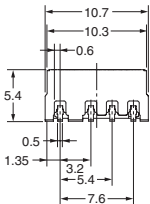
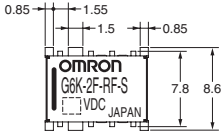
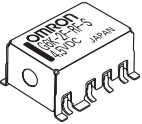

■ Tape Packing Specifications

- Add “-TR03” or “-TR09” to the end of the model number to order Relays in tape packing. If “-TR” is not added, the Relays will be provided in tray packing.

Relays per reel: 300 for “-TR03”
900 for “-TR09”

1. Direction of Relay Insertion

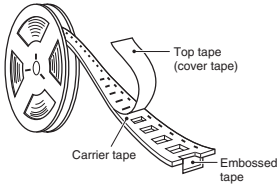

Pulling Direction
G6K(U)-2F-RF

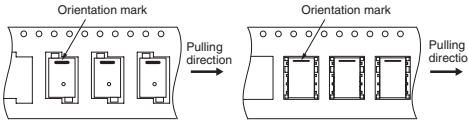

3. Carrier Tape Dimensions

G6K(U)-2F-RF3

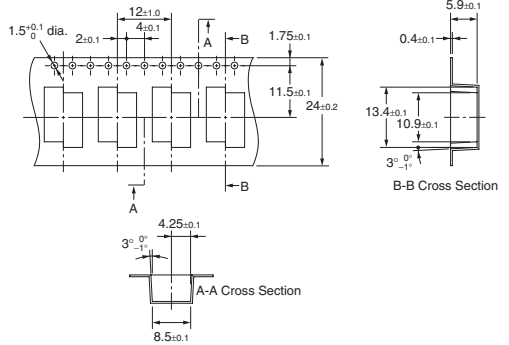

G6K(U)-2F-RF-S

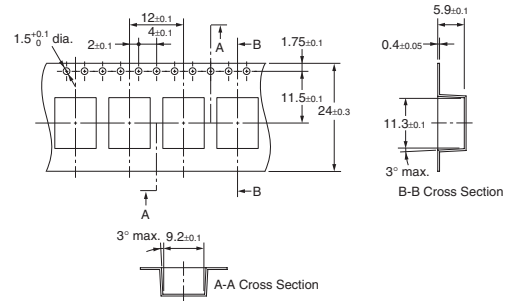

2. Reel Dimensions

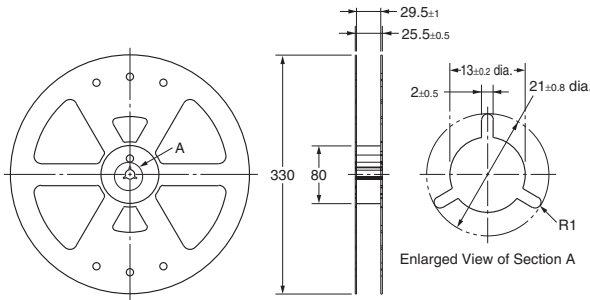

Recommended Soldering Method

Recommended Conditions for IRS Method (Surface-mounting Terminals)

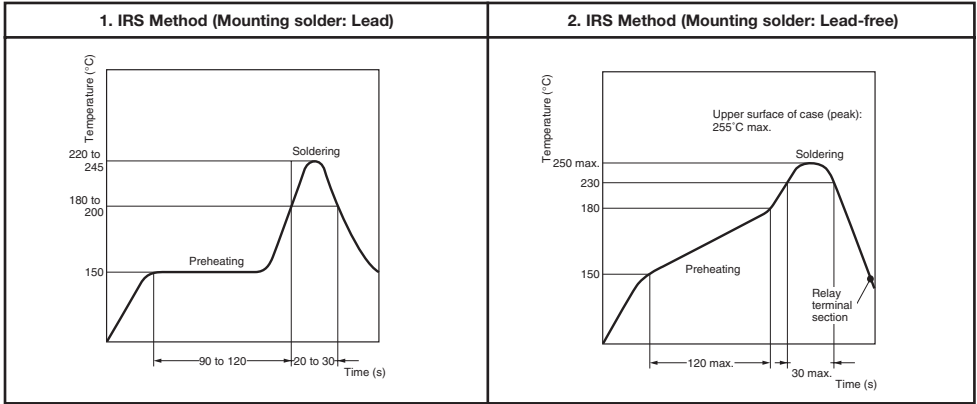

Note: Do not submerge the relay in a solder bath. Doing so will deform the resin causing faulty operation.

Note: The temperature profile indicates the temperature on the circuit board surface.

The thickness of cream solder to be applied should be between 200 and 250 μm and the land pattern should be based on OMRON's recommended PCB pattern.

To maintain the correct soldering joint shown in the following diagram, we recommend applying solder with the soldering conditions shown on the left.

Correct Soldering

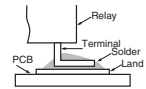

Incorrect Soldering

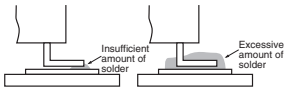

Check the soldering in the actual mounting conditions before use.

Safety Precautions

■ Precautions for Correct Use

Handling

Use the Relay as soon as possible after opening the moisture-proof package. If the Relay is left for a long time after opening the moisture-proof package, the appearance may suffer and seal failure may occur after the solder mounting process. To store the Relay after opening the moisture-proof package, place it into the original package and sealed the package with adhesive tape.

When washing the product after soldering the Relay to a PCB, use a water-based solvent or alcohol-based solvent, and keep the solvent temperature to less than 40°C. Do not put the Relay in a cold cleaning bath immediately after soldering.

Environmental Conditions for Usage, Storage, and Transport

Avoid direct sunlight when using, storing, or transporting the Relay and maintain normal temperature, humidity, and pressure conditions.

Long-term Continuously ON Contacts

Using the Relay in a circuit where the Relay will be ON continuously for long periods (rather than switching) can lead to unstable contacts because the heat generated by the coil itself will affect the insulation and can cause a film to develop on the contact surfaces. We recommend using a latching relay

(magnetic-holding relay) in this kind of circuit. If a single-side stable model must be used in this kind of circuit, we recommend adding fail-safe circuits in case the contact fails or the coil burns out.

Claw Securing Force During Automatic Mounting

During automatic insertion of Relays, be sure to set the securing force of each claw to the following so that the Relay's characteristics will be maintained.

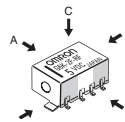

Direction A: 1.96 N max.
Direction B: 4.90 N max.
Direction C: 1.96 N max.

Secure the claws to the shaded area.
Do not attach them to the center of the Relay or just one part of the Relay.

Coating

Do not use silicone coating to coat the Relay when it is mounted to the PCB. Do not wash the PCB after the Relay is mounted using detergent containing silicone. Otherwise, the detergent may remain on the surface of the Relay.

Repeatability

Contact your Omron representative if the relay will be used in applications that require high repeatability with high-frequency characteristics in microload regions.