

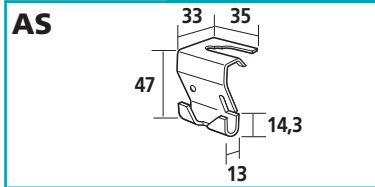

## AS

CF30 - CF54 - CF80 - CF105

100 → 600mm

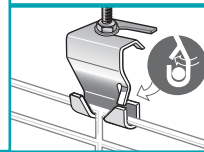
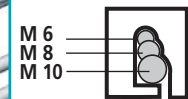
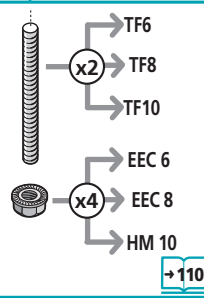
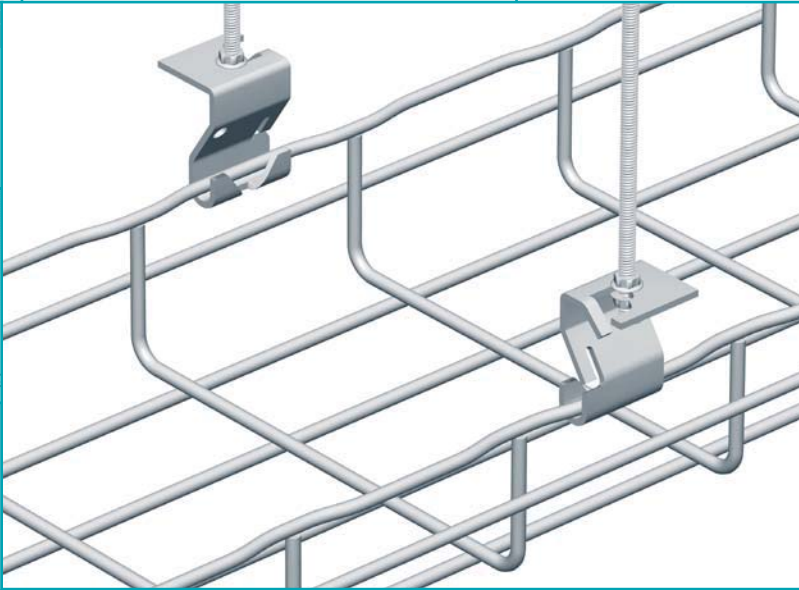
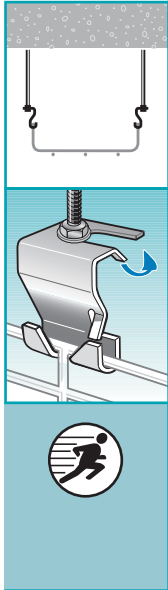

AS	$l$	<b>KG</b>	$\downarrow F$	<b>GS</b>	<b>GC</b>	<b>304L</b>	<b>316L</b>
	mm	Kg/100	daN				
AS		5	100	586 020	586 023	-	586 024

## RCSN

CF30 - CF54 - CF80 - CF105

100 → 600mm

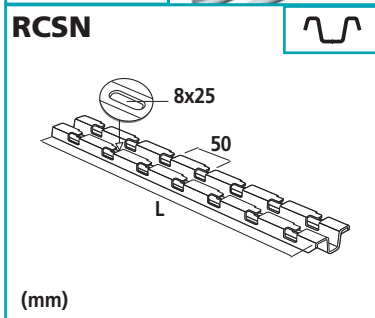
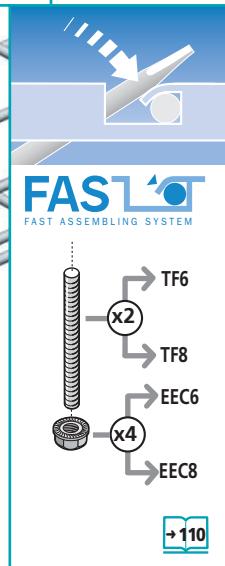
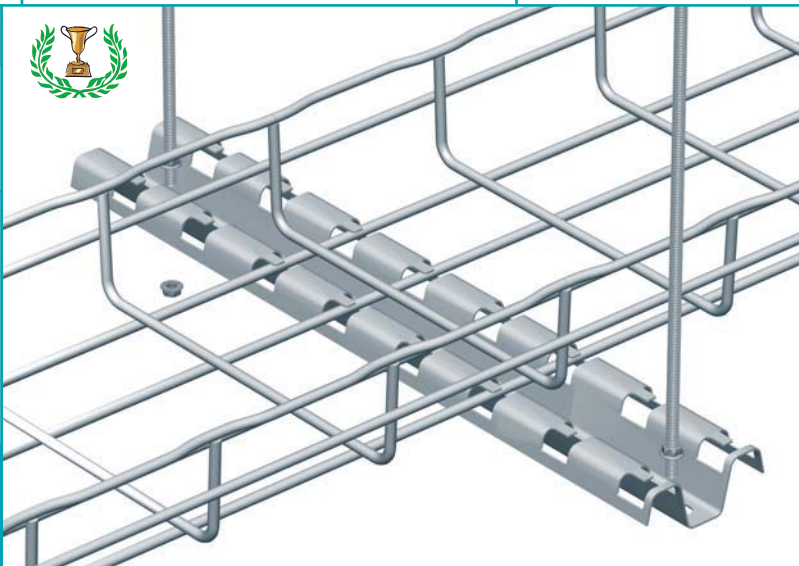

RCSN	$L$	<b>KG</b>	$\downarrow F$	<b>GS</b>	<b>GC</b>	<b>304L</b>	<b>316L</b>
	mm	Kg/1	daN				
RCSN 150	150	0,2		013 150	013 153	-	013 154
RCSN 200	200	0,3		013 200	013 203	-	013 204
RCSN 300	300	0,4		013 300	013 303	-	013 304
RCSN 400	400	0,5		013 400	013 403	-	013 404
RCSN 500	500	0,6		013 500	013 503	-	-
RCSN 600	600	0,7		013 600	013 603	-	013 604
RCSN 1000	1000	1,2		013 010	013 013	-	013 014
RCSN 2000	2000	2,4		013 020	013 023	-	013 024
RCSN 3000	3000	3,6		013 030	013 033	-	013 034

