

# Spezifikation für Freigabe / specification for release

Kunde / customer :  
 Artikelnummer / part number : **74408943150**  
 Bezeichnung : **SPEICHERDROSSEL WE-SPC 4838**  
 description : **POWER CHOKE WE-SPC 4838**



DATUM / DATE : 2011-10-05

## A Mechanische Abmessungen / dimensions:

size	4838	
------	------	--

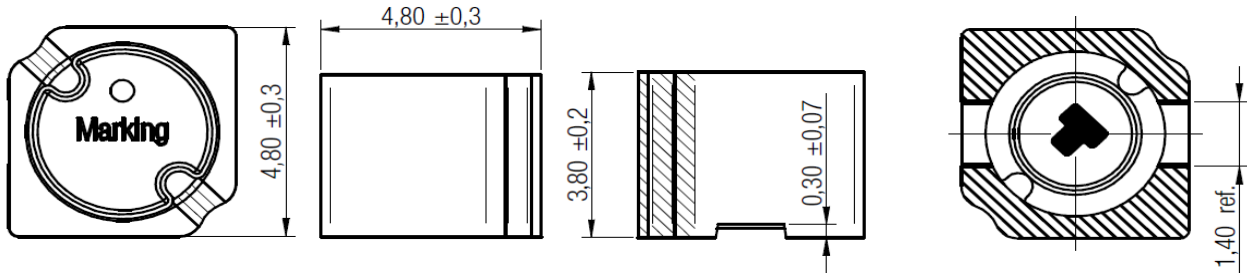

## B Elektrische Eigenschaften / electrical properties:

Eigenschaften / properties	Testbedingungen / test conditions		Wert / value	Einheit / unit	tol.
Induktivität / inductance	100 kHz / 1mA	L	15	μH	±20%
DC-Widerstand / DC-resistance	@ 20°C	R <sub>DC</sub> typ.	118	mΩ	typ.
DC-Widerstand / DC-resistance	@ 20°C	R <sub>DC</sub> max.	136	mΩ	max.
Nennstrom / rated Current	ΔT = 40 K	I <sub>R</sub>	1,4	A	max.
Sättigungsstrom / saturation current	ΔL/L  - 35%	I <sub>sat</sub>	1,7	A	typ.
Eigenres.-Frequenz / self-res.-frequency		f <sub>res</sub>	22	MHz	typ.

## C Lötpad / soldering spec.:

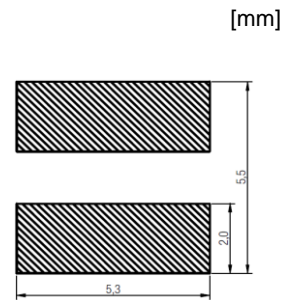

## D Prüfgeräte / test equipment:

**WAYNE KERR 3260B** für/for L; I<sub>sat</sub>  
**Dostmann T900** für/for I<sub>R</sub>  
**Metra HIT 27I** für/for R<sub>DC</sub>  
**Agilent E4991A** für/for f<sub>res</sub>

## E Testbedingungen / test conditions:

Luftfeuchtigkeit / humidity: 33%  
 Umgebungstemperatur / temperature: +20°C

## F Werkstoffe & Zulassungen / material & approvals:

Basismaterial / base material: Ferrit / ferrite  
 Draht / wire: Class H / 180°C  
 Endoberfläche / finishing electrode: Ag/Ni/Sn

## G Eigenschaften / general specifications:

Betriebstemp. / operating temperature: -40°C - + 125°C  
 Umgebungstemp. / ambient temperature: -40°C - + 85°C  
 It is recommended that the temperature of the part does not exceed 125°C under worst case operating conditions.

Freigabe erteilt / general release:	<b>Kunde / customer</b>			
.....	.....			
Datum / date	Unterschrift / signature			
	<b>Würth Elektronik</b>			
.....	.....	CZ	Version 3	11-10-05
.....	.....	CZ	Version 1	11-02-25
Geprüft / checked	Kontrolliert / approved	Name	Änderung / modification	Datum / date

### Würth Elektronik eiSos GmbH & Co. KG

D-74638 Waldenburg · Max-Eyth-Strasse 1 · Germany · Telefon (+49) (0) 7942 - 945 - 0 · Telefax (+49) (0) 7942 - 945 - 400  
<http://www.we-online.de>

# Spezifikation für Freigabe / specification for release

Kunde / customer :  
 Artikelnummer / part number : **74408943150**  
 Bezeichnung : **SPEICHERDROSSEL WE-SPC 4838**  
 description : **POWER CHOKE WE-SPC 4838**



DATUM / DATE : 2011-10-05

## H Induktivitätskurve / Inductance curve:

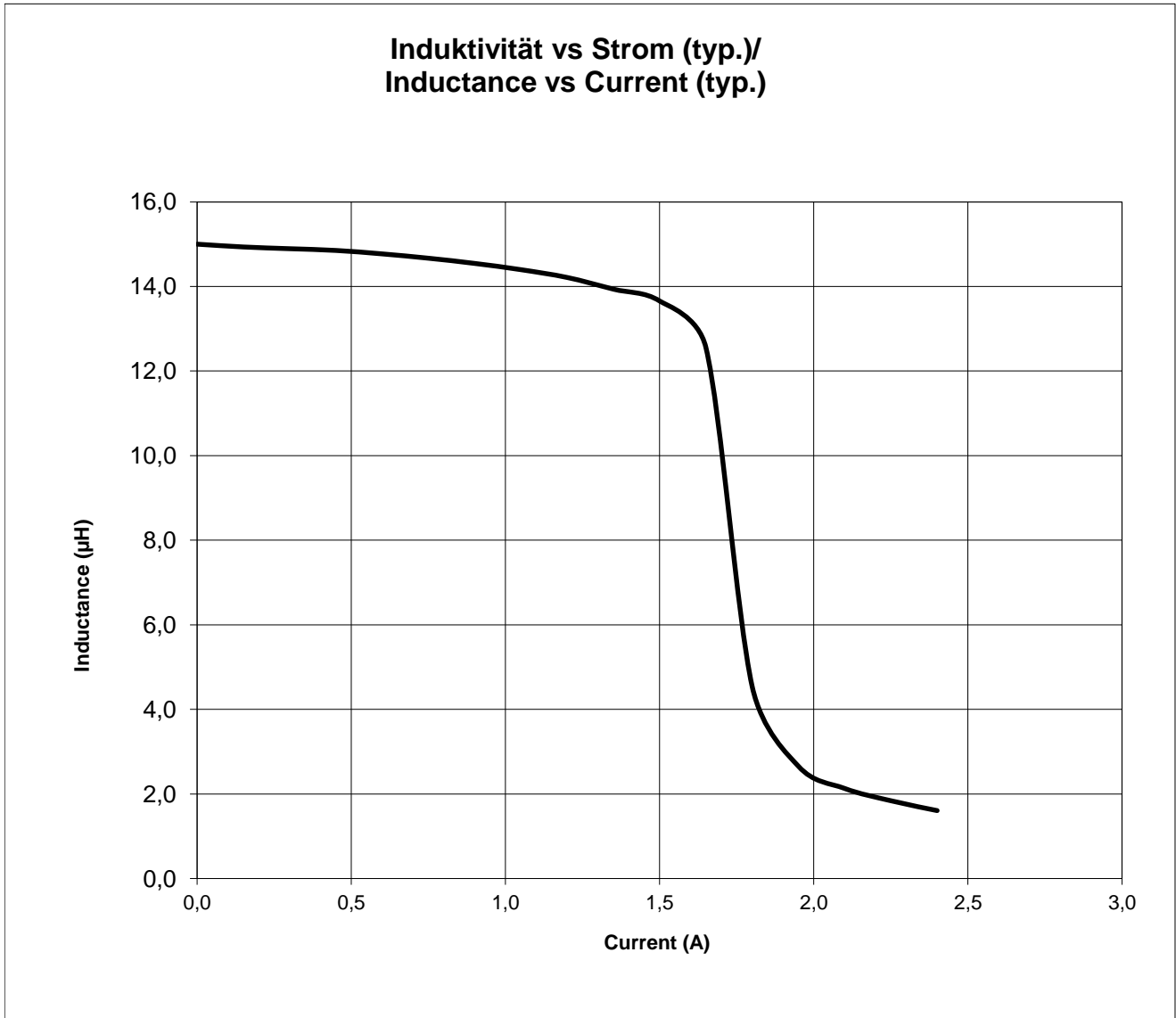

Freigabe erteilt / general release:	<b>Kunde / customer</b>			
Datum / date	Unterschrift / signature			
	<b>Würth Elektronik</b>			
Geprüft / checked	Kontrolliert / approved	CZ	Version 3	11-10-05
		CZ	Version 1	11-02-25
		Name	Änderung / modification	Datum / date

# Spezifikation für Freigabe / specification for release

Kunde / customer :  
 Artikelnummer / part number : **74408943150**  
 Bezeichnung : **SPEICHERDROSSEL WE-SPC 4838**  
 description : **POWER CHOKE WE-SPC 4838**



DATUM / DATE : 2011-10-05

## I Rollenspezifikation / tape and reel specification:

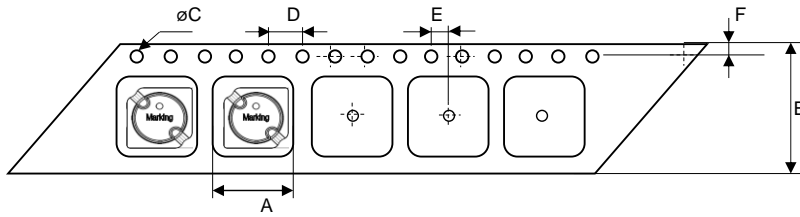

Gurtspezifikation / Tape specification:		
A	<b>5,3 ± 0,1</b>	mm
B	<b>12,00 ± 0,3</b>	mm
C	<b>1,50 ± 0,1</b>	mm
D	<b>4,00 ± 0,1</b>	mm
E	<b>2,00 ± 0,1</b>	mm
F	<b>1,75 ± 0,1</b>	mm
G	<b>5,10 ± 0,1</b>	mm
H	<b>4,15 ± 0,1</b>	mm

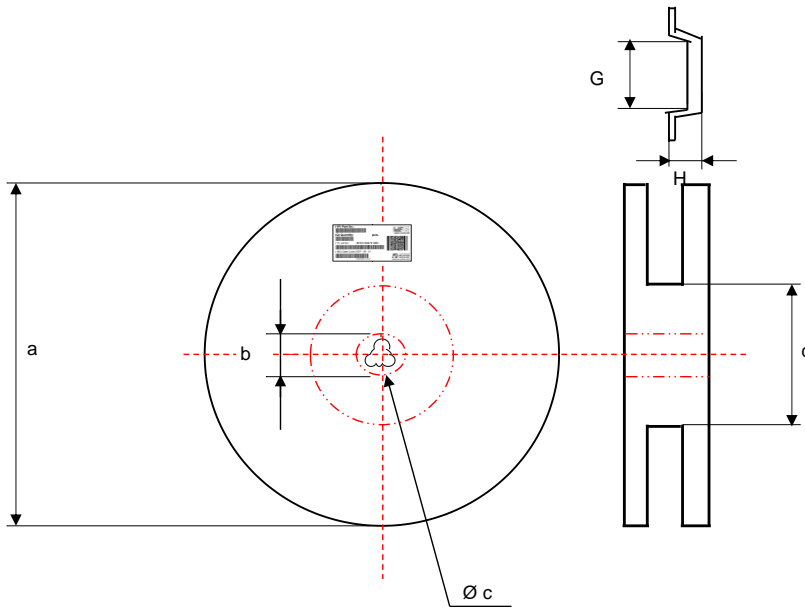

Rollenspezifikation / Reel specification:		
a	<b>178,0 ± 2,0</b>	mm
b	<b>21,00 ± 0,8</b>	mm
c	<b>13,00 ± 0,5</b>	mm
d	<b>62,00 ± 1,5</b>	mm

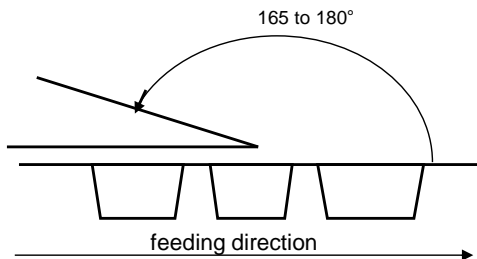

The force for tearing off cover tape is 10 to 130 grams in arrow direction

Freigabe erteilt / general release:	<b>Kunde / customer</b>			
Datum / date	Unterschrift / signature			
Geprüft / checked	<b>Würth Elektronik</b>			
	Kontrolliert / approved	Name	Änderung / modification	Datum / date
		CZ	Version 3	11-10-05
		CZ	Version 1	11-02-25

This electronic component has been designed and developed for usage in general electronic equipment. Before incorporating this component into any equipment where higher safety and reliability is especially required or if there is the possibility of direct damage or injury to human body, for example in the range of aerospace, aviation, nuclear control, submarine, transportation, (automotive control, train control, ship control), transportation signal, disaster prevention, medical, public information network etc, Würth Elektronik eiSos GmbH must be informed before the design-in stage. In addition, sufficient reliability evaluation checks for safety must be performed on every electronic component which is used in electrical circuits that require high safety and reliability functions or performance.

### Würth Elektronik eiSos GmbH & Co. KG

D-74638 Waldenburg · Max-Eyth-Strasse 1 · Germany · Telefon (+49) (0) 7942 - 945 - 0 · Telefax (+49) (0) 7942 - 945 - 400  
<http://www.we-online.de>