

FLUKE®

71X Series

Process Calibrators

Calibration Manual

PN 686540

January 1998 Rev. 5, 11/01

© 1998-2001 Fluke Corporation, All rights reserved. Printed in U.S.A.
All product names are trademarks of their respective companies.

LIMITED WARRANTY & LIMITATION OF LIABILITY

Each Fluke product is warranted to be free from defects in material and workmanship under normal use and service. The warranty period for the 71x Series Calibrator is three years and begins on the date of shipment. The warranty period for the 718 Pump assembly is one year and begins on the date of shipment. Parts, product repairs and services are warranted for 90 days. This warranty extends only to the original buyer or end-user customer of a Fluke authorized reseller, and does not apply to fuses, disposable batteries or to any product which, in Fluke's opinion, has been misused, altered, neglected or damaged by accident or abnormal conditions of operation or handling. Fluke warrants that software will operate substantially in accordance with its functional specifications for 90 days and that it has been properly recorded on non-defective media. Fluke does not warrant that software will be error free or operate without interruption.

Fluke authorized resellers shall extend this warranty on new and unused products to end-user customers only but have no authority to extend a greater or different warranty on behalf of Fluke. Warranty support is available if product is purchased through a Fluke authorized sales outlet or Buyer has paid the applicable international price. Fluke reserves the right to invoice Buyer for importation costs of repair/replacement parts when product purchased in one country is submitted for repair in another country.

Fluke's warranty obligation is limited, at Fluke's option, to refund of the purchase price, free of charge repair, or replacement of a defective product which is returned to a Fluke authorized service center within the warranty period.

To obtain warranty service, contact your nearest Fluke authorized service center or send the product, with a description of the difficulty, postage and insurance prepaid (FOB Destination), to the nearest Fluke authorized service center. Fluke assumes no risk for damage in transit. Following warranty repair, the product will be returned to Buyer, transportation prepaid (FOB Destination). If Fluke determines that the failure was caused by misuse, alteration, accident or abnormal condition of operation or handling, Fluke will provide an estimate of repair costs and obtain authorization before commencing the work. Following repair, the product will be returned to the Buyer transportation prepaid and the Buyer will be billed for the repair and return transportation charges (FOB Shipping Point).

THIS WARRANTY IS BUYER'S SOLE AND EXCLUSIVE REMEDY AND IS IN LIEU OF ALL OTHER WARRANTIES, EXPRESS OR IMPLIED, INCLUDING BUT NOT LIMITED TO ANY IMPLIED WARRANTY OF MERCHANTABILITY OR FITNESS FOR A PARTICULAR PURPOSE. FLUKE SHALL NOT BE LIABLE FOR ANY SPECIAL, INDIRECT, INCIDENTAL OR CONSEQUENTIAL DAMAGES OR LOSSES, INCLUDING LOSS OF DATA, WHETHER ARISING FROM BREACH OF WARRANTY OR BASED ON CONTRACT, TORT, RELIANCE OR ANY OTHER THEORY.

Since some countries or states do not allow limitation of the term of an implied warranty, or exclusion or limitation of incidental or consequential damages, the limitations and exclusions of this warranty may not apply to every buyer. If any provision of this Warranty is held invalid or unenforceable by a court of competent jurisdiction, such holding will not affect the validity or enforceability of any other provision.

To locate an authorized service center, visit us on the World Wide Web at www.fluke.com or call Fluke using the phone numbers listed below:

USA: 1-888-99-FLUKE (1-888-993-5853)
Canada: 1-800-36-FLUKE (1-800-363-5853)
Europe: +31 402-678-200
Japan: +81-3-3434-0181
Singapore: +65-738-5655
Anywhere in the world: +1-425-446-5500

Fluke Corporation
P.O. Box 9090
Everett WA 98206-9090
U.S.A

Fluke Europe B.V.
P.O. Box 1186
5602 B.D.
Eindhoven, The Netherlands

Table of Contents

Title	Page
Introduction.....	1
Precautions and Safety Information.....	2
Explanation of International Symbols	4
Specifications.....	5
712 Specifications	6
Firmware V1.1 and Earlier.....	6
Firmware V1.2 and Later	8
713 Specifications	10
714 Specifications	12
715 Specifications	13
716 Specifications	14
717 Specifications	15
718 Specifications	17
Basic Maintenance.....	19
Cleaning.....	19
Replacing the Battery	19
Replacing the Fuse	21
Required Equipment	24
Verification.....	26
Preparing for Verification	26
712 Verification (V1.1 and Earlier)	26
Resistance Measure Verification	26
Resistance Source Verification.....	27
Keypad Test	27
Display Verification.....	27
712 Verification (V1.2 and Later).....	28
713 Verification.....	30
Pressure Verification.....	30
mA Measure Verification.....	31
Display Verification.....	31
714 Verification.....	32
Thermocouple Measure Verification	32
Thermocouple Source Verification.....	33
Keypad Test	34
Display Verification.....	34

715 Verification.....	35
DC Voltage Source Verification.....	35
DC Current Source Verification.....	36
Keypad Test.....	36
DC Current Measure Verification.....	37
DC Voltage Measure Verification.....	38
Display Verification.....	38
716 Verification.....	39
mA Measure Verification.....	39
mA Loop Power Verification.....	39
Sensor Jack Verification.....	40
717 Verification.....	41
Pressure Verification.....	41
mA Measure Verification.....	42
mA Loop Power Verification.....	42
Sensor Jack Verification.....	43
718 Verification.....	44
Pressure Verification.....	44
Leak Test Verification.....	45
mA Measure Verification.....	46
Display Verification.....	46
mA Loop Power Verification.....	47
Sensor Jack Verification.....	47
Calibration.....	48
Preparing for Calibration.....	48
712 Calibration (V1.1 and Earlier).....	48
Millivolts Measure.....	48
Resistance Measure.....	49
mA Measure.....	49
712 Calibration (V1.2 and Later).....	50
713 Calibration.....	52
mA Measure Measure.....	52
Pressure Measure.....	52
714 Calibration.....	54
Temperature Measure.....	54
Temperature Source.....	54
Thermocouple Block Calibration.....	54
715 Calibration.....	56
mA/Volts Measure.....	56
mA/Volts Source Measure.....	57
716 Calibration.....	58
mA Measure.....	58
717 Calibration.....	59
mA Measure.....	59
Pressure Measure.....	59
718 Calibration.....	61
mA Measure.....	61
Pressure Measure.....	61
Replacement Parts.....	63

List of Tables

Table	Title	Page
1.	International Symbols	4
2.	General Specifications	5
3.	712 Supported RTD Types.....	6
4.	712 RTD and Ohms Simulation.....	7
5.	712 RTD and Ohms Measurement.....	7
6.	RTD Specifications	8
7.	Ohms Specifications.....	9
8.	713 30G Pressure Input.....	10
9.	713 100G Pressure Input.....	10
10.	713 Pressure Range and Resolution.....	11
11.	713 30G and 713 100G DC mA Input	11
12.	714 Temperature Measure and Thermocouple Simulate	12
13.	714 Millivolt Measure and Source.....	12
14.	715 DC V Input and Output	13
15.	715 DC mA Input and Output	13
16.	716 Pressure Display, Pressure Module Input	14
17.	716 DC mA Input	14
18.	717 30G Pressure Display, Pressure Sensor Input.....	15
19.	717 100G Pressure Input.....	15
20.	717 30G Pressure Display, Pressure Module Input	15
21.	717 30G and 717 100G DC mA Input	15
22.	717 30G Pressure Sensor Range and Resolution	16
23.	718 30G Pressure Input.....	17
24.	718 100G Pressure Input.....	17
25.	Pressure Module Input	17
26.	718 30G and 718 100G DC mA Input	17
27.	718 Pressure Range and Resolution.....	18
28.	Leak Rate for 718 30G and 718 100G	18
29.	Verifying a Blown Fuse	21
30.	Required Calibration Equipment	24
30.	Required Calibration Equipment	25
31.	712 Resistance Measure Verification	26
32.	712 Resistance Source Verification	27
33.	712 Verification RTD Values	28
34.	712 Verification Resistance Values.....	28

35.	712 Verification Outputs.....	29
36.	713 Pressure Verification.....	30
37.	713 mA Measure Verification.....	31
38.	714 Thermocouple Measure Verification	32
39.	714 Thermocouple Measure Verification (mA).....	32
40.	714 Thermocouple Source Verification (mA)	33
41.	714 Thermocouple Source Verification (Temperature).....	33
42.	715 DC Voltage Source Verification (0.000 to 10.000 V)	35
43.	715 DC Voltage Source Verification (0.00 to 100.00 V)	35
44.	715 DC Current Source Verification	36
45.	715 DC Current Measure Verification.....	37
46.	715 DC Voltage Measure Verification (10.0000 to 0.0000 V).....	38
47.	715 DC Voltage Measure Verification (0.0000 mV to 100.0000 mV).....	38
48.	716 mA Measure Verification.....	39
49.	717 Pressure Verification.....	41
50.	717 mA Measure Verification.....	42
51.	718 Pressure Verification.....	45
52.	718 Leak Test Verification	45
53.	718 mA Measure Verification.....	46
54.	Replaceable Parts and Accessories	63

List of Figures

Figure	Title	Page
1.	Proper Use of Tools (713, 717 and 718 Models).....	3
2.	Replacing the Battery.....	19
3.	Replacing the Battery (718 only).....	20
4.	Replacing the Fuses (715 shown).....	23
5.	Replacing the Fuse (718 shown).....	23
6.	Exploded View (718 shown).....	64

Introduction

⚠ Warning

The information provided in this document is for the use of qualified personnel only. Do not perform the verification tests or calibration procedures described in this manual unless you are qualified to do so.

The information in this manual deals with the 71X Series Process Calibrators (hereafter referred to as “the calibrator” or the “71X Calibrator”). The 71X Series includes the 712, 713 30G, 713 100G, 714, 715, 716, 717 30G, 717 100G, 718 30G and 718 100G models.

This manual provides the following information:

- Precautions and safety information
- Specifications
- Basic maintenance (cleaning, replacing the battery and fuses)
- Verification test procedures
- Calibration and calibration adjustment procedures
- Accessories and replaceable parts

To contact Fluke, call:

USA: 1-800-44-FLUKE (1-800-443-5853)

Canada: 1-800-36-FLUKE (1-800-363-5853)

Europe: +31 402-678-200

Japan: +81-3-3434-0181

Singapore: +65-738-5655

Anywhere in the world: +1-425-446-5500

For additional information about Fluke, its products, and services, visit Fluke’s web site at: www.fluke.com.

Precautions and Safety Information

Use the calibrator only as specified in this manual. Otherwise, the protection provided by the calibrator may be impaired.

A Warning statement identifies conditions and actions that pose hazard(s) to the user; a Caution statement identifies conditions and actions that may damage the calibrator. The following Warning statement applies to all of the 71X Calibrators unless noted:

⚠ Warning

To avoid possible electric shock or personal injury:

- **Never apply more than 30 V between any two terminals or between any terminal and earth ground.**
- **Make sure the battery door is closed and latched before you operate the calibrator.**
- **Remove test leads or attached thermocouple miniplug (714 only) from the calibrator before you open the battery door.**
- **Do not operate the calibrator if it is damaged.**
- **Do not operate the calibrator around explosive gas, vapor or dust.**
- **When servicing the calibrator, use only specified replacement parts.**
- **When using probes, keep fingers behind the finger guards on the probes.**
- **Do not allow water inside the case.**
- **Follow all equipment safety procedures.**
- **713, 716, 717 30G, 717 100G, 718 30G and 718 100G only: To avoid a violent release of pressure in a pressurized system, shut off the valve and slowly bleed off the pressure before you attach or detach the calibrator pressure fitting to the pressure line.**
- **718 30G and 718 100G only: Use only two 9 V batteries, properly installed in the calibrator case, to power the calibrator.**
- **718 30G and 718 100G only: Turn off circuit power before connecting the calibrator mA and COM terminals in the circuit. Place calibrator in series with the circuit.**
- **To avoid false readings, which could lead to possible electric shock or personal injury, replace the batteries as soon as the low battery indicator (⊕) appears.**
- **Use only type 9 V batteries, properly installed in the meter case, to power the meter.**

Caution

The 71X Series Calibrators contain parts that can be damaged by static discharge. If you open the case, follow the standard practices for handling static sensitive devices.

Use the proper jacks, function, and range for your measurement or output application.

Models 713, 717 30G, 717 100G, 718 30G and 718 100G only:

- To avoid mechanically damaging the calibrator, do not apply torque between the pressure fitting and the calibrator case. See Figure 1 for the proper use of tools.
- To avoid overpressure damage, do not apply pressure that exceeds the following:

Models 713 30G, 717 30G and 718 30G:

- 3X top of range (90 psi, 620 kPa, 6.2 bar)

Models 713 100G, 717 100G and 718 100G:

- 2X top of range (200 psi, 1380 kPa, 13.8 bar)

713, 717 and 718 only:

- To avoid corrosion in the pressure sensor, use the calibrator only with media compatible with glass, ceramic, silicon, RTV, nitrile, (Buna -N) type 303 stainless steel, and nickel.

718 30G and 718 100G only:

- To avoid damage to the pump, use with dry air and non-corrosive gases only. Use of the optional Fluke 700-ILF In-Line Filter may help isolate the pump from contaminants.

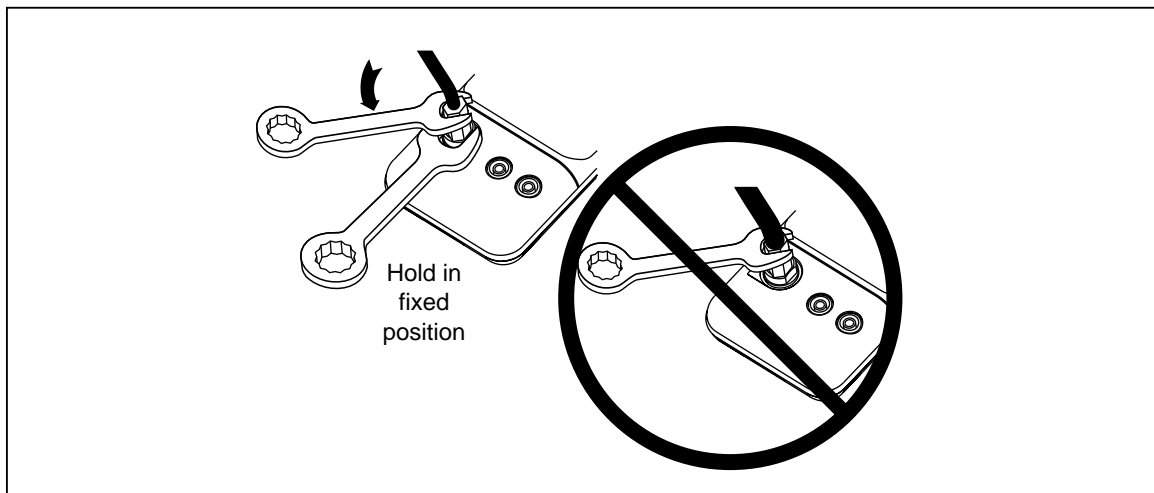









Figure 1. Proper Use of Tools (713, 717 and 718 Models)

kf01f.eps

Explanation of International Symbols

The following symbols are used on the calibrator or in this calibration manual. Table 1 explains their meaning.

Table 1. International Symbols

Symbol	Meaning
	Earth ground
	Fuse
	Battery
	Refer to the instrument instruction sheet for information about this feature
	Double insulated
	Conforms to relevant Canadian Standards Association directives
	Pressure
	Conforms to European Union directives

Specifications

Specifications for the 71X Calibrators are based on a one-year calibration cycle and apply for ambient temperatures from + 18 °C to + 28 °C unless stated otherwise. “Counts” are the number of increments or decrements of the least significant digit. General specifications for all models are in Table 2.

Table 2. General Specifications

Maximum voltage applied between any terminal and earth ground or between any two terminals:	30 V
Storage temperature:	712: -20 °C to 60 °C All other models: -40 °C to 60 °C
Operating temperature:	-10 °C to 55 °C
Operating altitude:	3000 meters maximum
Relative humidity:	95 % up to 30 °C 75 % up to 40 °C 45 % up to 50 °C 35 % up to 55 °C
Vibration:	Random 2 g, 5 Hz to 500 Hz
Shock:	1 meter drop test
Safety: 712, 713, 714, 715, 716, 717	Certified as compliant to CAN/CSA C22.2 No. 1010.1:1992 NRTL
Safety: 718	Complies with ANSI/ISA S82.01-1994 Certified as compliant to CAN/CSA C22.2 No. 1010.2:1995 Complies with ANSI/ISA S82.01-1995
Power requirements: 712, 713, 714, 715, 716, 717	Single 9 V battery (ANSI/NEDA 1604A or IEC 6LR61)
Power requirements: 718	Two 9 V batteries (ANSI/NEDA 1604A or IEC 6LR61)
Size: 712, 713, 714, 715, 716, 717	34.9 mm H x 87 mm W x 187 mm L; With holster and Flex-Stand: 52 mm H x 98 mm W x 201 mm L
Size: 718	60 mm H x 87 mm W x 210 mm L; With holster: 66 mm H x 94 mm W x 216 mm L
Weight:	
712	337 g; With holster and Flex-Stand: 587 g
713	369 g; With holster and Flex-Stand: 624 g
714	332 g; With holster and Flex-Stand: 584 g
715	349 g; With holster and Flex-Stand: 601 g
716, 717 30G, 717 100G	369 g; With holster and Flex-Stand: 624 g
718 30G and 718 100G	737 g; With holster: 992G

712 Specifications

Specifications for the 712 Calibrator are provided for instruments with firmware versions 1.1 and earlier, and for instruments with firmware versions 1.2 and greater. To display the firmware version for your instrument, start with the 712 off, press and hold , then press the power button.

Firmware V1.1 and Earlier

Table 3. 712 Supported RTD Types

RTD Type	Temperature Range and Resolution	Allowable Excitation ¹
	°C	mA
Ni 120	-80.0 to 260.0	0.15 to 2.00
Pt 100 385	-200.0 to 800.0	0.15 to 2.00
Pt 200 385	-200.0 to 630.0	0.15 to 2.00
Pt 500 385	-200.0 to 630.0	0.05 to 0.80
Pt 1000 385	-200.0 to 630.0	0.05 to 0.40
Pt 100 392	-200.0 to 630.0	0.15 to 2.00
Pt 100 JIS	-200.0 to 630.0	0.15 to 2.00
	Range and Resolution for Ohms Simulate and Measure	
R ²	15.0 Ω to 400.0 Ω	0.15 to 2.00
R	400.0 Ω to 1500.0 Ω	0.05 to 0.80
R	1500.0 Ω to 3200.0 Ω	0.05 to 0.40

Addresses pulsed transmitters and PICs with pulses ≥ 100 ms.

1: This column is for simulate mode only. It shows the allowable excitation current from an ohmmeter or RTD measurement device connected to the calibrator.

2: The R annunciator signifies “resistance,” not an RTD type. Select it the same way as an RTD type.

Resolution

RTD: 0.1 °C
Ohms: 0.1 Ω

Temperature Coefficient

0.005 % of ohms range per °C for temperature ranges -10 °C to 18 °C and 28 °C to 55 °C. Ohms ranges are 400 Ω, 1.5 kΩ, and 3.2 kΩ.

Table 4. 712 RTD and Ohms Simulation

Ohms Range	Excitation Current from Measurement Device	Accuracy, ± Ω
15 Ω to 400 Ω	0.15 mA to 0.5 mA	0.15
15 Ω to 400 Ω	0.5 mA to 2 mA	0.1
400 Ω to 1.5 kΩ	0.05 mA to 0.8 mA	0.5
1.5 kΩ to 3.2 kΩ	0.05 mA to 0.4 mA	1
Maximum input voltage: 30 V		

Table 5. 712 RTD and Ohms Measurement

Ohms Range	Accuracy, Four-Wire ± Ω
15 Ω to 400 Ω	0.1
400 Ω to 1.5 kΩ	0.5
1.5 kΩ to 3.2 kΩ	1
Maximum input voltage: 30 V Excitation current from 712: 0.3 mA	

Firmware V1.2 and Later

Table 6. RTD Specifications

RTD Type	Range °C (°F)	Accuracy (°C)			Allowable Excitation (mA)
		Input		Output	
		4-Wire	2-Wire & 3-Wire		
Ni 120	-80.0 to 260.0 (-112.0 to 500.0)	0.2	0.3	0.2	0.1 to 3.0
Pt 100 385	-200.0 to 800.0 (-328.0 to 1472.0)	0.33	0.5	0.33	0.1 to 3.0
Pt 200 385	-200.0 to 250.0 (-328.0 to 482.0)	0.2	0.3	0.2	0.1 to 3.0
	250.0 to 630.0 (482.0 to 1166.0)	0.8	1.6	0.8	
Pt 500 385	-200.0 to 500.0 (-328.0 to 932.0)	0.3	0.6	0.3	0.05 to 0.8
	500.0 to 630.0 (932.0 to 1166.0)	0.4	0.9	0.4	
Pt 1000 385	-200.0 to 100.0 (-328.0 to 212.0)	0.2	0.4	0.2	0.05 to 0.4
	100.0 to 630.0 (212.0 to 1166.0)	0.2	0.5	0.2	
Pt 100 392 (3926)	-200.0 to 630.0 (-328.0 to 1166.0)	0.3	0.5	0.3	0.1 to 3.0
Pt 100 JIS (3916)	-200.0 to 630.0 (-328.0 to 1166.0)	0.3	0.5	0.3	0.1 to 3.0

Addresses pulsed transmitters and PLCs with pulses as short as 5 ms.
 Allowable Excitation is for Output mode only. It shows the allowable excitation current from an ohmmeter or RTD measurement device connected to the calibrator.
 Excitation current from 712: 0.2 mA.
 Maximum input voltage: 30 V

Table 7. Ohms Specifications

Ohms Range	Input Accuracy 4-Wire $\pm \Omega$	Output Accuracy $\pm \Omega$	Allowable Excitation (mA)
0 Ω to 400 Ω	0.1	0.15	0.1 to 0.5
		0.1	0.5 to 3.0
400 Ω to 1.5 k Ω	0.5	0.5	0.05 to 0.8
1.5 k Ω to 3.2 k Ω	1	1	0.05 to 0.4

Allowable Excitation is for Output mode only. It shows the allowable excitation current from an ohmmeter or RTD measurement device connected to the calibrator.

Excitation current from 712: 0.2 mA.

Maximum input voltage: 30 V

Resolution

RTD: 0.1 °C
Ohms: 0.1 Ω

Temperature Coefficient

0.005 % of ohms range per °C for temperature ranges -10 °C to 18 °C and 28 °C to 55 °C. Ohms ranges are 400 Ω , 1.5 k Ω , and 3.2 k Ω .

713 Specifications

Table 8. 713 30G Pressure Input

Firmware Version*	Range	Accuracy
V1.2 or earlier	0 to 30 psi (206.85 kPa)	± 0.05 % of range
V1.3 or later	-12 psi (82.74 kPa) to 30 psi (206.85 kPa)	± 0.05 % of range

Maximum nondestructive pressure: 3X top of range (90 psi, 620 kPa, 6.2 bar)
 Temperature coefficient: 0.01 % of range per °C for temperature ranges -10 °C to 18 °C and 28 °C to 55°C
 * To display the firmware version, start with the 713 off, press and hold **MAX**, then press the power button.

Table 9. 713 100G Pressure Input

Firmware Version*	Range	Accuracy
V1.2 or earlier	0 to 100 psi (689.5 kPa)	± 0.05 % of range
V1.3 or later	-12 psi (-82.8 kPa) to 100 psi (689.5 kPa)	± 0.05 % of range

Maximum nondestructive pressure: 2X top of range (200 psi, 1380 kPa, 13.8 bar)
 Temperature coefficient: 0.01% of range per °C for temperature ranges -10 °C to 18 °C and 28 °C to 55 °C
 * To display the firmware version, start with the 713 off, press and hold **MAX**, then press the power button.

Table 10. 713 Pressure Range and Resolution

Displayed Pressure Units	Model 713 30G Range and Resolution	Model 713 100G Range and Resolution
psi	30.000 psi	100.00 psi
inH ₂ O at 4 °C	830.4 inH ₂ O	2768.0 inH ₂ O
inH ₂ O at 20 °C	831.9 inH ₂ O	2772.9 inH ₂ O
cmH ₂ O at 4 °C,	2109.0 cmH ₂ O	7030 cmH ₂ O
cmH ₂ O at 20 °C	2113.0 cmH ₂ O	7043 cmH ₂ O
bar	2.0685 bar	6.895 bar
mbar	2068.5 mbar	6895 mbar
kPa	206.85 kPa	689.5 kPa
inHg	61.080 inHg	203.6 inHg
mmHg	1551.3 mmHg	5171 mmHg
kg/cm ²	2.1090 kg/cm ²	7.030 kg/cm ²

Table 11. 713 30G and 713 100G DC mA Input

Range	Resolution	Accuracy, ±(% of Reading + Counts)
24 mA	0.001 mA	0.025 + 1
Overload protection: 125 mA, 250 V fast acting fuse Temperature coefficient: 0.005 % of range per °C for temperature ranges – 10 °C to 18 °C and 28 °C to 55 °C		

714 Specifications

Table 12. 714 Temperature Measure and Thermocouple Simulate

TC Type	Resolution	Error	Reference Junction Error
J, K, T, E, L, U	0.1 °C	$\pm (0.3 \text{ °C} + 10 \text{ } \mu\text{V})$	$\pm 0.2 \text{ °C}$
B, R, S	1 °C	$\pm (0.3 \text{ °C} + 10 \text{ } \mu\text{V})$	$\pm 0.2 \text{ °C}$
Maximum input voltage: 30 V Temperature Coefficient: 0.05 x specified accuracy per °C for temperature ranges – 10 °C to 18 °C and 28 °C to 55 °C			

Table 13. 714 Millivolt Measure and Source

Range	Resolution	Accuracy
-10 mV to 75 mV	0.01 mV	$\pm (0.025 \% \text{ of range (75 mV)} + 1 \text{ count})$
Maximum input voltage: 30 V		

715 Specifications

Table 14. 715 DC V Input and Output

Range	Resolution	Accuracy, ± (% of Reading + Counts)
100 mV	0.01 mV	0.02 % + 2
10 V	0.001 V	0.02 % + 2
Input impedance: 2 MΩ (nominal), < 100 pF Overvoltage protection: 30 V Voltage drive capability: 1 mA		

Table 15. 715 DC mA Input and Output

Range	Resolution	Accuracy, ± (% of Reading + Counts)
24 mA	0.001 mA	0.02 % + 2
Overload protection: 125 mA, 250 V fast acting fuse mA Output: 0 % = 4 mA, 100 % = 20 mA		

Temperature Coefficient

0.005 % of ohms range per °C for temperature ranges – 10 °C to 18 °C and 28 °C to 55 °C

Source mode

Compliance: 1000 Ω at 20 mA for battery voltage ≥ 6.8 V (700 Ω at 20 mA for battery voltage 5.8 to 6.8 V)

Simulate mode

External loop voltage requirement: 24 V nominal, 30 V maximum, 12 V minimum

Loop Power

24 V ± 10 %

716 Specifications

Table 16. 716 Pressure Display, Pressure Module Input

Range	Resolution	Accuracy
(determined by pressure module)		

Table 17. 716 DC mA Input

Range	Resolution	Accuracy, ± (% of Reading + Counts)
24 mA	0.001 mA	0.025 + 1
<i>Overload protection: 125 mA, 250 V fast acting fuse</i>		
<i>Temperature coefficient: 0.005 % of range per °C for temperature ranges -10 °C to 18 °C and 28 °C to 55 °C</i>		

Loop Supply

24 V ±10%

717 Specifications

Table 18. 717 30G Pressure Input

Firmware Version *	Range	Accuracy
V1.2 or earlier	0 to 30 psi (206.85 kPa)	± 0.05 % of range
V1.3 or greater	-12 psi (-82.74 kPa) to 30 psi (206.85 kPa)	± 0.05 % of range
<i>Maximum nondestructive pressure: 3X top of range (90 psi, 620 kPa, 6.2 bar)</i> <i>Temperature coefficient: 0.01 % of range per °C for temperature ranges -10 °C to 18 °C and 28 °C to 55 °C</i> * To display the firmware version, start with the 717 off, press and hold MAX , then press the power button.		

Table 19. 717 100G Pressure Input

Range	Accuracy
-12 psi (82.74 kPa) to 100 psi (689.5 kPa)	± 0.05 % of range
<i>Maximum nondestructive pressure: 2X top of range (200 psi, 1380 kPa, 13.8 bar)</i> <i>Temperature coefficient: 0.01 % of range per °C for temperature ranges - 10 °C to 18 °C and 28 °C to 55 °C</i>	

Table 20. 717 30G Pressure Display, Pressure Module Input

Range	Resolution	Accuracy
(determined by Pressure Module)		

Table 21. 717 30G and 717 100G DC mA Input

Range	Resolution	Accuracy, ± (% of Reading + Counts)
24 mA	0.001 mA	0.025 + 1
<i>Overload protection: 125 mA, 250 V fast acting fuse</i> <i>Temperature coefficient: 0.005 % of range per °C for temperature ranges -10 °C to 18 °C and 28 °C to 55 °C</i>		

Table 22. 717 30G and 717 100G Pressure Sensor Range and Resolution

Displayed Pressure Units	Model 717 30G Range and Resolution	Model 717 100G Range and Resolution
psi	-12.000 to 30.000	-12.00 to 100.00
inH ₂ O at 4 °C	-332.16 to 830.40	-333.2 to 2768.0
inH ₂ O at 20 °C	-332.75 to 831.87	-332.8 to 2772.9
cmH ₂ O at 4 °C,	-843.6 to 2109.0	-843.6 to 7030.0
cmH ₂ O at 20 °C	-845.2 to 2113.0	-845.2 to 7043.0
bar	-0.8274 to 2.0685	-0.8274 to 6.8950
mbar	-827.4 to 2068.5	-827.4 to 6895.0
kPa	-82.74 to 206.85	-82.74 to 689.50
inHg	-24.432 to 61.080	-24.43 to 203.60
mmHg	-620.6 to 1551.4	-620.6 to 5171.5
kg/cm ²	-0.8437 to 2.1090	-0.8437 to 7.0306

Loop Supply

24 V Nominal

718 Specifications

Table 23. 718 30G Pressure Input

Range	Accuracy
-12 psi (-82.74 kPa) to 30 psi (206.85 kPa)	± 0.05 % of range
Maximum nondestructive pressure: 3X top of range (90 psi, 620 kPa, 6.2 bar) Temperature coefficient: 0.01 % of range per °C for temperature ranges – 10 °C to 18 °C and 28 °C to 55 °C	

Table 24. 718 100G Pressure Input

Range	Accuracy
-12 psi (82.74 kPa) to 100 psi (689.5 kPa)	± 0.05 % of range
Maximum nondestructive pressure: 2X top of range (200 psi, 1380 kPa, 13.8 bar) Temperature coefficient: 0.01 % of range per °C for temperature ranges – 10 °C to 18 °C and 28 °C to 55 °C	

Table 25. Pressure Module Input

Range	Resolution	Accuracy
(determined by Pressure Module)		

Table 26. 718 30G and 718 100G DC mA Input

Range	Resolution	Accuracy, ± (% of Reading + Counts)
24 mA	0.001 mA	0.025 + 1
Overload protection: 125 mA, 250V fast acting fuse Temperature coefficient: 0.005 % of range per °C for temperature ranges – 10 °C to 18 °C and 28 °C to 55 °C		

Table 27. 718 Pressure Range and Resolution

Displayed Pressure Units	Model 718 30G Range and Resolution	Model 718 100G Range and Resolution
psi	30.000 psi	100.00 psi
inH ₂ O at 4 °C	830.4 inH ₂ O	2768.0 inH ₂ O
inH ₂ O at 20 °C	831.9 inH ₂ O	2772.9 inH ₂ O
cmH ₂ O at 4 °C,	2109.0 cmH ₂ O	7030 cmH ₂ O
cmH ₂ O at 20 °C	2113.0 cmH ₂ O	7043 cmH ₂ O
bar	2.0685 bar	6.895 bar
mbar	2068.5 mbar	6895 mbar
kPa	206.85 kPa	689.5 kPa
inHg	61.080 inHg	203.6 inHg
mmHg	1551.3 mmHg	5171 mmHg
kg/cm ²	2.1090 kg/cm ²	7.030 kg/cm ²

Table 28. Leak Rate for 718 30G and 718 100G

Model	Leak Rate*
Fluke 718 30G	0.050 PSI/minute maximum
Fluke 718 100G	0.10 PSI/minute maximum

*Leak rate is to be measured after rated pressure is applied for one minute.

Loop Supply

24 V Nominal

Basic Maintenance

For maintenance procedures not described in this manual, contact an authorized service center.

Cleaning

Periodically wipe the case with a damp cloth and mild detergent. Do not use abrasives or solvents.

Replacing the Battery

⚠ Warning

To avoid false readings, which could lead to possible electric shock or personal injury, replace the battery as soon as the battery indicator (➡) appears.

To replace the battery in models 712,713,714,715,716 and 717, refer to Figure 2.

To replace batteries in model 718 30G and 718 100G, refer to Figure 3.

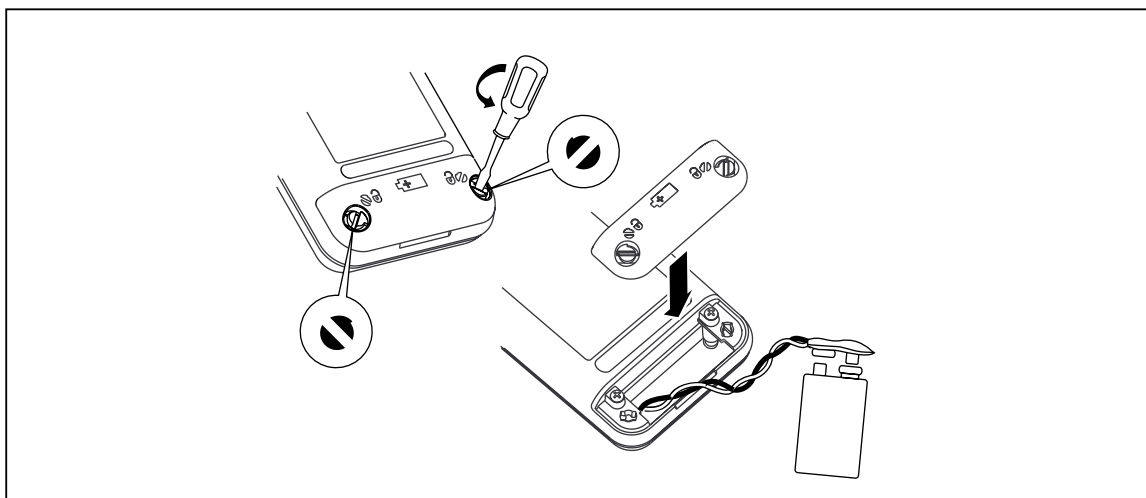
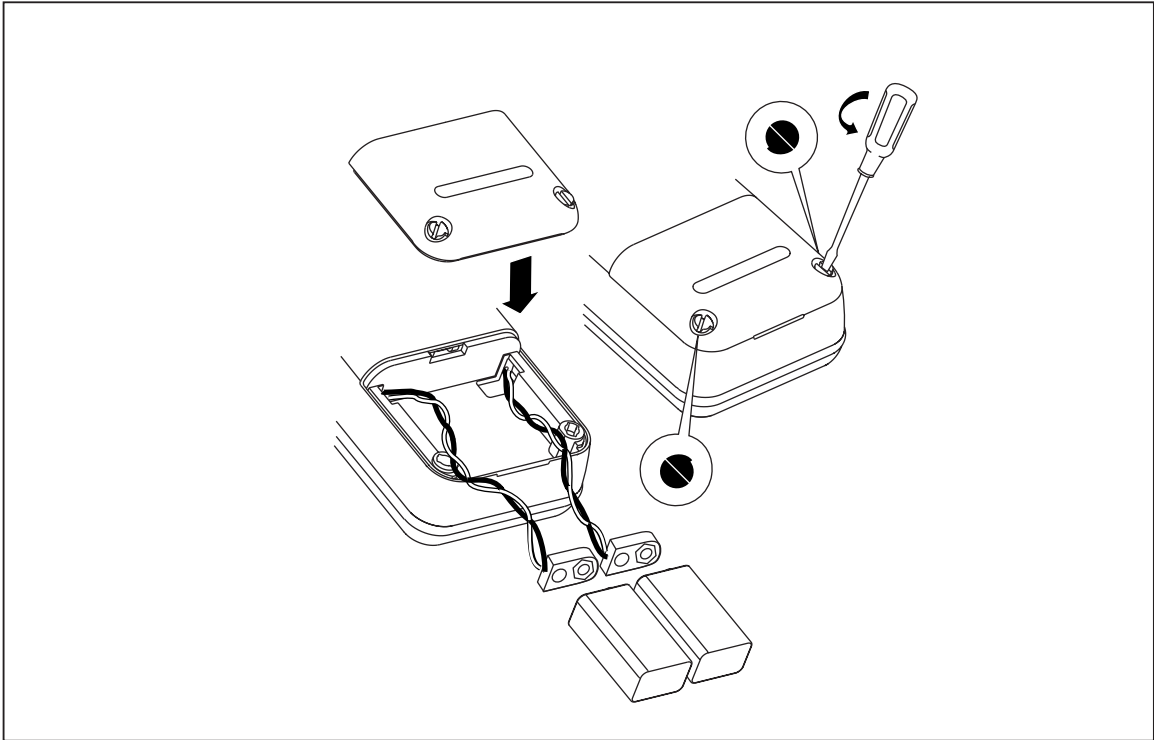

Figure 2. Replacing the Battery

it07i.eps



Wh008f.eps

Figure 3. Replacing the Battery (718 only)

Replacing the Fuse

Warning

To avoid personal injury or damage to the calibrator, use only a 0.125A 250V fast fuse, Littelfuse® 2AG.

To check if the fuse(s) are blown, refer to Table 29.

Table 29. Verifying a Blown Fuse

Calibrator Model	Determining a Blown Fuse
712 V1.1	Put the calibrator in simulate mode (OUTPUT on the display), and check for proper resistance at the calibrator's OUTPUT terminals. An open or very high impedance suggests fuse F1 is blown.
712 V1.2	Fuse F1 is probably blown if no current comes from the center jacks when in input 2W mode. Fuse F2 is probably blown when output mode will not work.
713 Series 716 717 Series 718 Series	Fuse F1 is probably blown if the mA measurement display reading does not respond to current applied to the current (mA) inputs.
714	Fuse F1 is probably blown if, in the input mode, the calibrator always reads OL, even with a thermocouple connected.
715	<p>Fuse F1 is probably blown if:</p> <ul style="list-style-type: none"> • in the mA input mode, the calibrator always reads 0.000, even with a signal applied. • in the mA output mode, with a short across the mA OUTPUT jacks, OL is flashing on the display. <p>Fuse F2 is probably blown if:</p> <ul style="list-style-type: none"> • in the V output mode, with the test leads removed from the calibrator, the display flashes OL. • in the V input mode, the calibrator always displays OL, even with a signal applied that is within the measurement range.

Replace the fuse(s) as follows, refer to Figures 4 and 5:

1. Remove the test leads and turn the calibrator off.
2. Remove the battery door.
3. Remove the three Phillips-head screws from the case bottom and turn the case over.
4. Gently lift the top cover from the end nearest the input jacks until it unsnaps from the bottom cover.
5. Replace the fuse(s) with a 0.125 A 250 V fast fuse, Littelfuse® type 2AG. F1 and F2 are the same type on the 715 and 712 V1.2.
6. (712, 714, and 715 only)
Fit the top and bottom covers together, engaging the two snaps. Make sure that the gasket is properly seated. Reinstall the three screws.
(713, 716, 717, and 718 only)
Carefully fit the case top and circuit board assembly together, making sure that the O-ring is properly seated between the pressure sensor and the pressure fitting on the case top. Fit the case bottom onto the case top, engaging the two snaps near the display end of the case. Reinstall the three screws.
7. Replace the battery door.

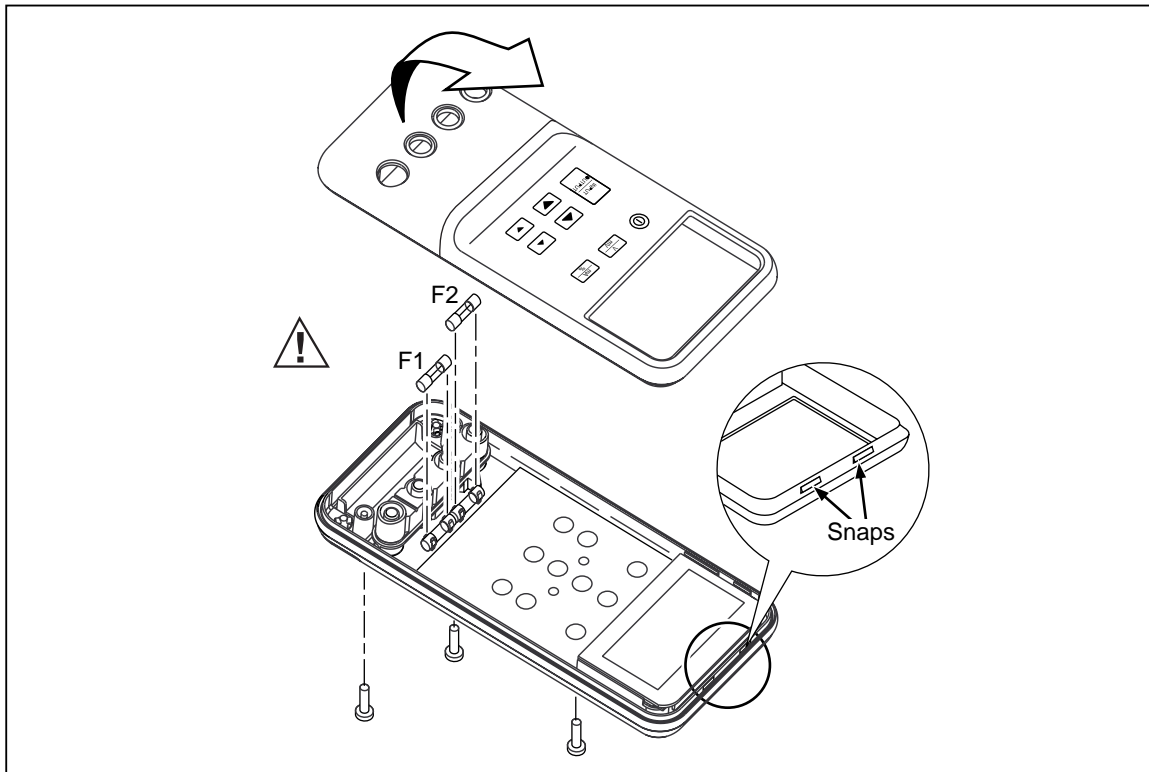

it08f.eps

Figure 4. Replacing the Fuses (715 shown)

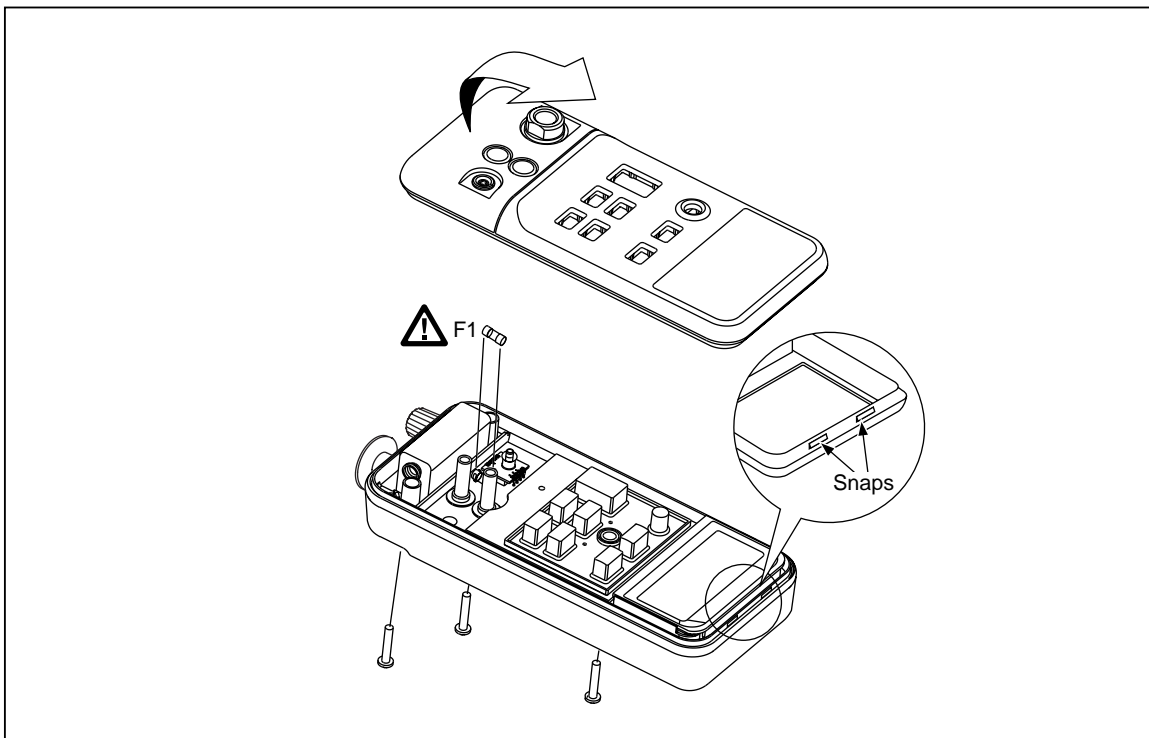

Wh003f.eps

Figure 5. Replacing the Fuse (718 shown)

Required Equipment

The equipment required to perform the verification and calibration procedures in this manual is identified in Table 30.

Table 30. Required Calibration Equipment

Calibrator Model	Equipment	Minimum Specifications	Recommended Model
712	DC Calibrator	5 to 3000 Ω Accuracy: 70 ppm + 0.025 Ω	Fluke 5520A
	Digital Multimeter	5 to 3000 Ω Accuracy: 70 ppm + 0.037 Ω	Fluke/Wavetek 1281
	Four Test Leads		5500A/LEADS
713	DC Calibrator	0 to 24 mA	Fluke 5520
	Digital Multimeter	0 to 24 mA Accuracy: 0.006 % + 0.25 mA	Fluke/Wavetek 1281
	Dead Weight Tester	-12 to 100 PSIG Accuracy: 0.012 % of range	
	Teflon Tape		
	Two Test Leads		5500A/LEADS
714	DC Calibrator	-10 to 75 mV Accuracy: 0.006 % + 0.25 mV	Fluke 5520A
	Digital Multimeter	-10 to 75 mV Accuracy: 0.006 % + 0.25 mV	Fluke/Wavetek 1281
	TC to Banana Test Leads	Copper Mini-Jack to Copper Wire	
	Type J TC Test Lead		5500A/LEADS
715	DC Calibrator	0 to 10 Volts Accuracy: 0.005 % + 0.5 mV	Fluke 5520A
	Digital Multimeter	0 to 10 Volts Accuracy: 0.005 % + 0.5 mV	Fluke/Wavetek 1281
	Two Test Leads		
716	DC Calibrator	0 to 24 mA	Fluke 5520A
	Digital Multimeter	0 to 24 mA Accuracy: 0.006 % + 0.25 mA	Fluke/Wavetek 1281
	Two Test Leads		5500A/LEADS
	700P Pressure Module		
	Load Resistors	1 k Ω & 2 k Ω 10% 0.5 W	

Table 30. Required Calibration Equipment (cont)

Calibrator Model	Equipment	Minimum Specifications	Recommended Model
717	DC Calibrator	0 to 24 mA	Fluke 5520A
	Digital Multimeter	0 to 24 mA Accuracy: 0.006 % + 0.25 mA	Fluke/Wavetek 1281
	Dead Weight Tester	-12 to 100 PSIG Accuracy: 0.012 % of range	
	Two Test Leads		5500A/LEADS
	700P Pressure Module		
	Load Resistors	1 k Ω & 2 k Ω 10% 0.5W	
718	DC Calibrator	0 to 24 mA	Fluke 5520A
	Digital Multimeter	0 to 24 mA Accuracy: 0.006 % + 0.25 mA	Fluke/Wavetek 1281
	Dead Weight Tester	-12 to 100 PSIG Accuracy: 0.012 % of range	
	Two Test Leads		5500A/LEADS
	700P Pressure Module		
	Load Resistors	1 k Ω & 2 k Ω 10% 0.5 W	

Verification

The following verification tests check the accuracy of each calibrator function against the calibrator's specifications. If the calibrator fails any of these tests, calibration adjustment or repair is required. Fluke recommends that you calibrate your 71X Calibrator once a year to ensure that it performs according to its specifications.

To perform the verification tests, it is not necessary to open the case or adjust the calibrator. Simply make the required connections, apply the designated source stimulus and determine if the measurements fall within the acceptable range indicated.

Note

Throughout this section, the 71X Calibrator may be referred to as the "UUT" (unit under test).

Preparing for Verification

To prepare for verification, do the following:

1. Make sure fuse(s) in the UUT are intact. By referring to Table 29, you should not have to open the unit.
2. Make sure you have the required test equipment available. (Refer to Table 30.)
3. Turn on and warm up the test equipment for the time required.
4. Allow UUT to come to ambient temperature. Turn it on and allow 5 minutes for warm-up of the UUT.

712 Verification (V1.1 and Earlier)

Resistance Measure Verification

1. Press the green \odot key to turn on the 712. Press the $\boxed{\text{INPUT OUTPUT}}$ key, the $\boxed{\text{RTD TYPE}}$ key, so that the display indicates:

INPUT TYPE R 4W
2. Configure the 712 Calibrator into a 4-wire ohms measurement:
 - Connect two test leads from the NORMAL jacks of the 5520A to the INPUT jacks (two middle jacks) on the 712 Calibrator (black to black, red to red).
 - Connect two additional test leads, also from the NORMAL jacks of the 5520A, to the 712 Calibrator (black wire to the 712 red jack labeled [3W NC] and red wire to the red jack labeled [4W NC]). All four input jacks of the 712 should now be configured in a 4-wire ohms measurement.
3. Set the Fluke 5520A to the settings in Table 31, and verify the reading as displayed on the 712 Calibrator:

Table 31. 712 Resistance Measure Verification

Fluke 5520A	Fluke 712
207.5 Ω	207.4 to 207.6 Ω
950.0 Ω	949.5 to 950.5 Ω
2350.0 Ω	2349.0 to 2351.0 Ω

4. Disconnect the test leads.

Resistance Source Verification

1. Using four test leads, connect the four jacks of Fluke/Wavetek 1281 (Ω Sense 'Hi & Lo' and Input 'Hi & Lo') to the two middle jacks of the 712 Calibrator (black to black; red to red). This puts the Fluke/Wavetek 1281 in a 4-wire configuration.
2. On the Fluke/Wavetek 1281, select four-wire ohms measurement and up-range to the 1 k Ω range. Use the 1 k Ω range for the first test point, and use the 10 k Ω range for the last two test points. Correct ranging is important in supplying the correct excitation current back into the 712 Calibrator. Otherwise the specifications may change, or the measurements may be incorrect.
3. Press the  key on the 712 Calibrator so that the display indicates:





OUTPUT

Using the large () and small () scroll keys, source the resistance settings in Table 32, verifying the readings on the Fluke/Wavetek 1281 display:



Table 32. 712 Resistance Source Verification

Fluke 712	Fluke/Wavetek 1281
207.5 Ω	.2074 to .2076 k Ω
950.0 Ω	.9495 to .9505 k Ω
2350.0 Ω	2.349 to 2.351 k Ω

Keypad Test

1. Press and hold the large  to source 950.0 ohms.
2. Press and hold the small  scroll key. Verify the numbers scrolling on the display changes in 0.1 increments, then changes in 1.0 increments, then in 10.0 increments.
3. Press and hold the small  scroll key. Verify the numbers scrolling on the display changes in 0.1 decrements, then changes in 1.0 decrements, then in 10.0 decrements.
4. Disconnect all test leads from the 712 Calibrator and press the  key to turn the calibrator off.

Display Verification

1. Press and hold the  key and then turn the 712 back on by pressing and releasing the green  key. This locks the 712 in a mode where all display segments are on. All segments will stay on until the  key is released.
2. Check to see that all segments of the LCD are displayed.
3. Turn the 712 off.

The 712 verification test is complete.

712 Verification (V1.2 and Later)

1. Press button until Input comes up on the display.
2. Press until PT100 392 JIS is on the display.
3. Press until 4W is on the display. Set temperature standard to C.
4. Set the 5520A to 2-wire output with 2-wire compensation turned off; then make 2-wire connections on the 5520A to 4-wire connections on the 712. Set the 5520A to PT 3916 (ITS-90) mode.
5. Set the 5520A to output the RTD (resistance) values in Table 33. Verify that the temperature readings are within the limits shown for 4-wire UUT.

Table 33. 712 Verification RTD Values

5520A Outputs (C)	3-wire 712 Readings (C)	4-wire 712 Readings (C)
-180 (25.799 Ohms)	-179.5 to -180.5	-179.7 to -180.3
100 (139.171 Ohms)	99.5 to 100.5	99.7 to 100.3
550 (300.822 Ohms)	549.5 to 550.5	549.7 to 550.3

6. Remove the 4-wire connection on the 712 (rightmost connection). Press once and verify that 3W is on the display and that the temperature readings are within the limits shown for 3-wire readings. Press to return to 4W mode.
7. Restore the 4-wire connection to the 712 and maintain 2-wire connection on the 5520A.
8. Press until Ω is displayed.
9. Set the 5520A to source resistance, to a 2-wire output, with 2-wire compensation turned off.
10. Set the 5520A to source the resistance values in Table 34. Verify that the resistance values on the 712 are within the limits shown.

Table 34. 712 Verification Resistance Values

5520A Outputs (Ω)	4-wire 712 Readings (Ω)
5.00	4.90 to 5.10
300.00	299.90 to 300.10
1500.0	1499.5 to 1500.5
30000.0	2999.0 to 3001.0

11. Make 2-wire connections on the 712 to 4-wire connections on the Fluke/Wavetek 1281. Set the Fluke/Wavetek 1281 to measure 4-wire resistance.
12. Press until OUTPUT is displayed.
13. Set the 712 to output the resistance values in Table 35. Verify that the Fluke/Wavetek 1281 readings are within the limits shown.

Table 35. 712 Verification Outputs

712 Outputs (Ohms)	Fluke/Wavetek 1281 Readings (Ohms)
5.00	4.90 to 5.10
300.00	299.90 to 300.10
1500.0	1499.5 to 1500.5
30000.0	2999.0 to 3001.0

14. Disconnect all connections to the 712. The 712 verification test is complete.

713 Verification

Pressure Verification

1. Carefully attach the pressure fitting of the deadweight tester to the pressure port of the 713 Calibrator.

Note

The use of TEFLON tape at the pressure fitting strengthens the seal.

2. Press the green \odot key to turn the 713 on.
3. The display should read 0.00 PSI with the deadweight tester opened up to ambient air. If not, press the $\boxed{\text{ZERO}}$ key until display does read 0.00 PSI.
4. Depending if the instrument being tested is a 713 30G or a 713 100G, set up the deadweight tester for the sequence of PSI inputs from Table 36 to be injected into the pressure port of the 713 Calibrator.
5. Ensure the pressure has stabilized at each input before verifying the display reading.
6. Carefully vent all pressure and disconnect the 713 from the deadweight tester.

Table 36. 713 Pressure Verification

713 30G		713 100G	
Input pressure	Display Reading	Input pressure	Display Reading
0 psi	-0.015 to 0.015	0 psi	-0.05 to 0.05
6 psi	5.985 to 6.015	20 psi	19.95 to 20.05
12 psi	11.985 to 12.015	40 psi	39.95 to 40.05
18 psi	17.985 to 18.015	60 psi	59.95 to 60.05
24 psi	23.985 to 24.015	80 psi	79.95 to 80.05
30 psi	29.985 to 30.015	100 psi	99.95 to 100.05
24 psi	23.985 to 24.015	80 psi	79.95 to 80.05
18 psi	17.985 to 18.015	60 psi	59.95 to 60.05
12 psi	11.985 to 12.015	40 psi	39.95 to 40.05
6 psi	5.985 to 6.015	20 psi	19.95 to 20.05
-12 psi *	-12.015 to -11.985	-12 psi*	-12.05 to -11.95

* Vacuum is only specified for V1.3 and later. To display the firmware version, start with the 713 off, press and hold $\boxed{\text{MAX}}$, then press the power button.

mA Measure Verification

The display should indicate:

0.000mA 0.00 PSI



1. Connect a test lead from Red AUX terminal of the 5520A to the Fluke/Wavetek 1281 I+ terminal.
2. Connect a test lead from Black AUX terminal of the 5520A to the 713 Calibrator Com terminal.
3. Connect a test lead from I- terminal of the Fluke/Wavetek 1281 to the 713 Calibrator mA terminal.
4. Adjust the 5520A if necessary so that the current shown on the Fluke/Wavetek 1281 is the same as the 5520A values shown in Table 37.
5. Verify that the display readings on the 713 calibrator are within the limits.

Table 37. 713 mA Measure Verification

Fluke 5520A	Fluke 713
4.0000 mA	3.998 mA to 4.002 mA
12.0000 mA	11.996 mA to 12.004 mA
24.0000 mA	23.993 mA to 24.007 mA

6. Disconnect the test leads and turn off the 713 Calibrator.

Display Verification

1. Press and hold the  key and then press and release the green © key. This locks the 713 in a mode where all display segments are on. All segments will stay on until the  key is released.
2. Check to see that all segments of the display are showing.
3. Turn the 713 off.

The 713 verification test is now complete.

714 Verification

Thermocouple Measure Verification

1. Press the \odot key to turn on the 714 Calibrator. Press the $\boxed{\text{INPUT/OUTPUT}}$ key and the $\boxed{\text{°C/°F}}$ key so that the display indicates:

INPUT xx.x °C

where xx.x is some variable number; or OL (overload) may be indicated.

2. Press the $\boxed{\text{TC/TYPE}}$ key to measure Type J thermocouple and connect the Type J thermocouple test lead from the TC jack of the Fluke 5520A to the TC jack on the 714 Calibrator, observing correct polarity.
3. Set the Fluke 5520A to output in Type J thermocouple, press the $\boxed{\text{OPR}}$ key, and set the 5520A to the settings in Table 38, verifying the display readings on the 714:

Table 38. 714 Thermocouple Measure Verification

Fluke 5520A	Fluke 714
-200.00 °C	-200.9 °C to -199.1 °C
0.00 °C	-0.7 °C to +0.7 °C
1200.00 °C	1199.3 °C to 1200.7 °C

4. Disconnect the Type J thermocouple test lead and install the two-wire copper test lead from the Fluke 5520A NORMAL jacks to the 714 Calibrator TC jack, observing correct polarity.
5. On the 714 press the $\boxed{\text{TC/TYPE}}$ key until "mV" is shown on the display.
6. Set the Fluke 5520A to the settings in Table 39, and verify the display readings on the 714 Calibrator.

Table 39. 714 Thermocouple Measure Verification (mA)

Fluke 5520A	Fluke 714
-10.0000 mV	-10.03 to -9.97 mV
30.0000 mV	29.97 to 30.03 mV
75.0000 mV	74.97 to 75.03 mV

7. Disconnect the copper test lead from the Fluke 5520A.

Thermocouple Source Verification

1. Set the Fluke/Wavetek 1281 to VDC and 200 mV range. Connect the two-wire copper test lead from the TC jack on the 714 Calibrator to the INPUT jacks of the Fluke/Wavetek 1281.
2. Press the  key on the 714 Calibrator to indicate:



OUPUT 0.00 mV
3. On the 714, press the large  and  scroll keys to source the voltages in Table 40 while verifying the readings on the Fluke/Wavetek 1281.

Table 40. 714 Thermocouple Source Verification (mV)

Fluke 714	Fluke/Wavetek 1281
-10.00 mV	-10.028 to -9.972 mV
30.00 mV	29.972 to 30.028 mV
75.00 mV	74.972 to 75.028 mV









4. Press the  key on the 714 Calibrator to TYPE J and disconnect the copper wire test lead.
5. Connect the Type J thermocouple test lead from the Fluke 5520A TC jack to the TC jack on the 714 Calibrator, observing correct polarity.
6. Set the Fluke 5520A to  with 'Type J' input. On the 714, press the large  and  scroll keys to source the temperatures in Table 41 while verifying the readings on the 5520A:

Table 41. 714 Thermocouple Source Verification (Temperature)



Fluke 714	Fluke 5520A
0.0 °C	-0.70 °C to +0.70 °C
-200.0 °C	-200.94 °C to -199.06 °C
1200 °C	1199.33 °C to 1200.67 °C

Keypad Test

1. On the 714 Calibrator, press the large  scroll key to 800.0 °C.
2. Press and hold the small  scroll key, verifying that the numbers scrolling on the display change in 0.1 increments, then change in 1.0 increments, then change in 10.0 increments.
3. Press and hold the  scroll key, verifying that the numbers scrolling on the display change in 0.1 decrements, then change in 1.0 decrements, then change in 10.0 decrements.
4. Scroll to 800.0 °C.
5. Press the  key on the 714 Calibrator. The display should change to:

OUTPUT 1472.0 °F
6. Disconnect the Type J test lead from the 714 Calibrator and press the  key to turn the calibrator off.

Display Verification

1. Press and hold the  key and then press and release the green  key. This locks the 714 in a mode where all display segments are on. All segments will stay on until the  key is released.
2. Check to see that all segments of the display are showing.
3. Turn the 714 off.

The 714 verification test is now complete.

715 Verification

DC Voltage Source Verification

1. On the 715 Calibrator turn the green \odot key on.
2. Press the $\frac{\text{INPUT}}{\text{OUTPUT}}$ and the $\frac{\text{V}}{\text{mV}}$ key so that the display indicates:
OUTPUT 0.000 V
3. Connect test leads from the Fluke/Wavetek 1281 input HI & LO jacks to the voltage jacks on the 715 Calibrator (black to COM and red to V).
4. Using the large \blacktriangle scroll button of the 715 Calibrator, press to step to the voltages in Table 42, verifying the output on the Fluke/Wavetek 1281:

Table 42. 715 DC Voltage Source Verification (0.000 to 10.000 V)

Fluke 715	Fluke/Wavetek 1281
0.000 V	-0.002 V to +0.002 V
5.000 V	4.997 V to 5.003 V
10.000 V	9.996 V to 10.004 V

5. Press the $\frac{\text{V}}{\text{mV}}$ key on the 715 Calibrator. Display should change to:
OUTPUT 0.00 mV
6. Using the large \blacktriangle key scroll button of the 715 Calibrator, press to step to the voltages in Table 43, verifying the output on the Fluke/Wavetek 1281.

Table 43. 715 DC Voltage Source Verification (0.00 to 100.00 V)

Fluke 715	Fluke/Wavetek 1281
0.00 mV	-0.02 mV to +0.02 mV
50.00 mV	49.97 mV to 50.03 mV
100.00 mV	99.96 mV to 100.04 mV

DC Current Source Verification

1. Disconnect the Fluke/Wavetek 1281. Press the $\frac{\text{mA}}{\%}$ key on the 715 Calibrator. The display should change to:
OUTPUT 0.000 mA
2. Connect test leads from the 715 Calibrator's mA output jacks (black to V jack and red to +LOOP jack) to the Fluke/Wavetek 1281 input mA jacks (black to I- and red to I+).
3. Set the Fluke/Wavetek 1281 function to [DC CURRENT]. Using the large \blacktriangle scroll button of the 715 Calibrator, press to step to the current outputs in Table 44, verifying the readings on the Fluke/Wavetek 1281.

Table 44. 715 DC Current Source Verification

Fluke 715	Fluke/Wavetek 1281
4.000 mA	3.9972 mA to 4.0028 mA
12.000 mA	11.9956 mA to 12.0044 mA
24.000 mA	23.9932 mA to 24.0068 mA

Keypad Test

1. Using the large \blacktriangledown scroll key, press to step down to 12.000 mA.
2. Using the small \blacktriangle scroll key, press to verify that the numbers scrolling on the display change in .001 increments; then change in .01 increments; then change in 0.1 increments.
3. Using the small \blacktriangledown scroll key, press to verify that the numbers scrolling on the display change in .001 decrements; then change in .01 decrements; then change in 0.1 decrements.
4. Scroll to 12.000 mA.
5. Press the $\frac{\text{mA}}{\%}$ key on the 715 Calibrator. Display should change to:

OUTPUT 50.00 mA %

DC Current Measure Verification

1. Press key on the 715 Calibrator. Display should indicate closely to:
INPUT -25.00 mA %
2. Press the key and the display should change to:
INPUT 0.000 mA
3. Connect a test lead from Red AUX terminal of the 5520A to the Fluke/Wavetek 1281 I+ terminal.
4. Connect a test lead from Black AUX terminal of the 5520A to the 715 Calibrator Com terminal.
5. Connect a test lead from I- terminal of the Fluke/Wavetek 1281 to the 715 Calibrator mA terminal.
6. Adjust the 5520A if necessary so that the current shown on the Fluke/Wavetek 1281 is the same as the 5520A values shown in Table 45.
7. Verify that the display readings on the 715 Calibrator are within the limits.

Table 45. 715 DC Current Measure Verification

Fluke 5520A	Fluke 715
24.0000 mA	23.993 mA to 24.007 mA
12.0000 mA	11.996 mA to 12.004 mA
4.0000 mA	3.998 mA to 4.002 mA

DC Voltage Measure Verification

1. Press the $\frac{V}{mV}$ key on the 715 Calibrator. Display should change to:
INPUT 0.000 V
2. Connect test leads from the output *NORMAL* jacks of the Fluke 5520A to the voltage jacks on the 715 Calibrator (black to *COM* jack and red to the *V* jack).
3. Set the Fluke 5520A for the voltage settings in Table 46, and verify the display readings on the 715 Calibrator.

Table 46. 715 DC Voltage Measure Verification (10.0000 to 0.0000 V)

Fluke 5520A	Fluke 715
10.00000 V	9.996 V to 10.004 V
5.00000 V	4.997 V to 5.003 V
0.0000 V	-0.002 V to +0.002 V

4. Press the $\frac{V}{mV}$ key on the 715 Calibrator. Display should indicate closely to:
INPUT 0.00 mV
5. Set the Fluke 5520A for the mV settings in Table 47, and verify display readings on the 715 Calibrator.

Table 47. 715 DC Voltage Measure Verification (0.0000 mV to 100.0000 mV)

Fluke 5520A	Fluke 715
0.0000 mV	-0.02 mV to + 0.02 mV
50.0000 mV	49.97 mV to 50.03 mV
100.0000 mV	99.96 mV to 100.04 mV

6. Disconnect the test leads from 715 Calibrator and turn the green Ⓢ key off.

Display Verification

1. Press and hold the $\frac{\text{INPUT}}{\text{OUTPUT}}$ key and then turn the 715 back on by pressing and releasing the green Ⓢ key. This locks the 715 in a mode where all display segments are on. All segments will stay on until the $\frac{\text{INPUT}}{\text{OUTPUT}}$ key is released.
2. Check to see that all segments of the LCD are displayed.
3. Turn the 715 off.

The 715 verification test is complete.

716 Verification

mA Measure Verification

1. Press the green Ⓞ button to turn the calibrator on. The display should read:
 ----- mA
 then change to:
 0.000 mA
2. Connect a test lead from Red AUX terminal of the 5520A to the Fluke/Wavetek 1281 I+ terminal.
3. Connect a test lead from Black AUX terminal of the 5520A to the 716 Calibrator Com terminal.
4. Connect a test lead from I- terminal of the Fluke/Wavetek 1281 to the 716 Calibrator mA terminal.
5. Adjust the 5520A if necessary so that the current shown on the Fluke/Wavetek 1281 is the same as the 5520A values shown in Table 48.
6. Verify that the display readings on the 716 Calibrator are within the limits.

Table 48. 716 mA Measure Verification

Fluke 5520A	Fluke 716
4.0000 mA	3.998 mA to 4.002 mA
12.0000 mA	11.996 mA to 12.004 mA
24.0000 mA	23.993 mA to 24.007 mA

7. Disconnect the test leads and press Ⓞ to turn the power off.

mA Loop Power Verification

1. Hold down both *LOOP POWER* keys (UNITS and Ⓞ) at the same time until the screen reads:
 ----- LOOP mA
 then release the keys.
2. Apply 1 k Ω to the mA jacks from the decade box or other resistor source. The display should read over 21 mA but less than OL.
3. Apply 2 k Ω to the mA jacks from the decade box or other resistor source. The display should read between 11 mA and 13 mA.
4. Press Ⓞ to turn the calibrator off.

Sensor Jack Verification

1. Make sure nothing is connected to the sensor port of the Fluke 716. Push \odot to turn the calibrator on. The display should read:

----- mA

then change to:

OL 0.000 mA

2. Plug the Fluke Pressure Module into the sensor port of the Fluke 716. The display should change to:

----- mA

A pressure value should appear on the screen after all of the calibration constants have been downloaded.

3. Disconnect the Fluke Pressure Module and push \odot to turn the Fluke 716 off.

717 Verification

Pressure Verification

1. Carefully attach the pressure fitting of the deadweight tester to the pressure port of the 717 30G Calibrator.

Note

Use Plenty of TEFLON tape when attaching pressure fitting.

The display should read 0.00 PSI with the deadweight tester opened up to ambient air. If not, press the **[ZERO]** key until display reads 0.00 PSI.

2. Set up the deadweight tester for the sequence of PSI inputs from Table 49 to be injected into the pressure port of the 717 Calibrator.
3. Ensure the pressure has stabilized at each input before verifying the display reading.

Table 49. 717 Pressure Verification

717-30G		717 100G	
Input Pressure	Display Reading	Input Pressure	Display Reading
0 psi	-0.015 to 0.015	0 psi	-0.05 to 0.05
6 psi	5.985 to 6.015	20 psi	19.95 to 20.05
12 psi	11.985 to 12.015	40 psi	39.95 to 40.05
18 psi	17.985 to 18.015	60 psi	59.95 to 60.05
24 psi	23.985 to 24.015	80 psi	79.95 to 80.05
30 psi	29.985 to 30.015	100 psi	99.95 to 100.05
24 psi	23.985 to 24.015	80 psi	79.95 to 80.05
18 psi	17.985 to 18.015	60 psi	59.95 to 60.05
12 psi	11.985 to 12.015	40 psi	39.95 to 40.05
6 psi	5.985 to 6.015	20 psi	19.95 to 20.05
-12 psi *	-12.015 to -11.985	-12 psi	-12.05 to -11.95

* Vacuum is only specified for V1.3 and later. To display the firmware version, start with the 717 off, press and hold **[MAX]**, then press the power button.

4. Carefully vent all pressure and disconnect the 717 from the deadweight tester.

mA Measure Verification

1. Press Ⓢ to turn power on. The display should read:
 ----- mA
 then change to:
 0.000 mA 0.00PSI
2. Connect a test lead from Red AUX terminal of the 5520A to the Fluke/Wavetek 1281 I+ terminal.
3. Connect a test lead from Black AUX terminal of the 5520A to the 717 Calibrator Com terminal.
4. Connect a test lead from I- terminal of the Fluke/Wavetek 1281 to the 717 Calibrator mA terminal.
5. Adjust the 5520A if necessary so that the current shown on the Fluke/Wavetek 1281 is the same as the 5520A values shown in Table 50.
6. Verify that the display readings on the 717 Calibrator are within the limits.

Table 50. 717 mA Measure Verification

Fluke 5520A	Fluke 717
4.0000 mA	3.998 mA to 4.002 mA
12.0000 mA	11.996 mA to 12.004 mA
24.0000 mA	23.993 mA to 24.007 mA

7. Disconnect the test leads and press Ⓢ to turn the power off.

mA Loop Power Verification

1. Hold down both *LOOP POWER* keys (UNITS and Ⓢ) at the same until the screen reads:
 ----- LOOP mA
 then release the keys.
2. Apply 1 k Ω to the mA jacks from the decade box or other resistor sources. The display should read over 21 mA but less than OL.
3. Apply 2 k Ω to the mA jacks from the decade box or other resistor source. The display should read between 11 mA and 13 mA.
4. Press Ⓢ to turn the power off.

Sensor Jack Verification

1. Make sure nothing is connected to the sensor port of the Fluke 717.
2. Turn power on. The display should read:
----- mA
then change to:
0.000 PSI
3. Plug the Fluke Pressure Module into the sensor port on the Fluke 717. The display should change to:
----- mA
A pressure value should appear on the screen after all of the calibration constants have been down loaded.
4. Disconnect the Fluke Pressure Module and press \odot to turn the Fluke 717 off.

718 Verification

Pressure Verification



⚠ Warning

To avoid a violent release of pressure or vacuum, always depressurize the system slowly using the pressure/vacuum release control before detaching any pressure line.

1. Carefully attach the pressure fitting of the deadweight tester to the pressure port of the 718 Calibrator.

Note

The use of TEFLON tape at the pressure fitting strengthens the seal.

2. Press the green  key to turn the 718 on.
3. The display should read 0.00 PSI with the deadweight tester opened up to ambient air. If not, press the  key until display does read 0.00 PSI.
4. Depending if the instrument being tested is a 718 30G or a 718 100G, set up the deadweight tester for the sequence of PSI inputs from Table 51 to be injected into the pressure port of the 718 Calibrator.
5. Ensure the pressure has stabilized at each input before verifying the display reading.
6. Carefully vent all pressure and disconnect the 718 from the deadweight tester.

Note

When verifying vacuum pressure make sure the pressure/vacuum switch is in the vacuum position. Forward (clockwise) is for pressure and backward (counter-clockwise) is for vacuum.

Table 51. 718 Pressure Verification

718 30G		718 100G	
Input Pressure	Display Reading	Input Pressure	Display Reading
0 psi	-0.015 to 0.015	0 psi	-0.05 to 0.05
6 psi	5.985 to 6.015	20 psi	19.95 to 20.05
12 psi	11.985 to 12.015	40 psi	39.95 to 40.05
18 psi	17.985 to 18.015	60 psi	59.95 to 60.05
24 psi	23.985 to 24.015	80 psi	79.95 to 80.05
30 psi	29.985 to 30.015	100 psi	99.95 to 100.05
24 psi	23.985 to 24.015	80 psi	79.95 to 80.05
18 psi	17.985 to 18.015	60 psi	59.95 to 60.05
12 psi	11.985 to 12.015	40 psi	39.95 to 40.05
6 psi	5.985 to 6.015	20 psi	19.95 to 20.05
-12 psi	-12.015 to -11.985	-12 psi	-12.05 to -11.95

Leak Test Verification

1. Seal off the pressure sensor input port.
2. Using the fine adjust knob, pressure-vacuum switch and internal pump, set the 718 to (approximately) the values in Table 52. Let the unit sit for one minute, then record the displayed value.
3. Wait for one more minute, then record a second reading. The difference between the first and the second reading is the leak rate.

Table 52. 718 Leak Test Verification

718 30G		718 100G	
Adjusted Pressure	Maximum Leak Rate	Adjusted Pressure	Maximum Leak Rate
-10.000 psi	0.05 psi/min	-10.00 psi	0.10 psi/min
3.000 psi	0.05 psi/min	3.00 psi	0.10 psi/min
30.000 psi	0.05 psi/min	100.00 psi	0.10 psi/min

mA Measure Verification

The display should indicate:

0.000mA 0.00 PSI

1. Connect a test lead from Red AUX terminal of the 5520A to the Fluke/Wavetek 1281 I+ terminal.
2. Connect a test lead from Black AUX terminal of the 5520A to the 718 Calibrator Com terminal.
3. Connect a test lead from I- terminal of the Fluke/Wavetek 1281 to the 718 Calibrator mA terminal.
4. Adjust the 5520A if necessary so that the current shown on the Fluke/Wavetek 1281 is the same as the 5520A values shown in Table 53.
5. Verify that the display readings on the 718 Calibrator are within the limits.

Table 53. 718 mA Measure Verification



Fluke 5520A	Fluke 718
4.0000 mA	3.998 mA to 4.002 mA
12.0000 mA	11.996 mA to 12.004 mA
24.0000 mA	23.993 mA to 24.007 mA

6. Disconnect the test leads and turn off the 718 Calibrator.



Display Verification

1. Press and hold the **ZERO** key and then press and release the green **Ⓢ** key. This locks the 718 in a mode where all display segments are on. All segments will stay on until the **ZERO** key is released.
2. Check to see that all segments of the display are showing.
3. Turn the 718 off. The 718 verification test is now complete.

mA Loop Power Verification

1. Hold down both *LOOP POWER* keys ( and ) at the same time until the screen reads:
----- LOOP mA
then release the keys.
2. Apply 1 k Ω to the mA jacks from the decade box or other resistor source. The display should read over 21 mA but less than OL.
3. Apply 2 k Ω to the mA jacks from the decade box or other resistor source. The display should read between 11 mA and 13 mA.
4. Press  to turn the calibrator off.

Sensor Jack Verification

1. Make sure nothing is connected to the sensor port of the Fluke 718. Push  to turn the calibrator on. The display should read:
----- mA
then change to:
OL 0.000 mA
2. Plug the Fluke Pressure Module into the sensor port of the Fluke 718. The display should change to:
----- mA
A pressure value should appear on the screen after all of the calibration constants have been downloaded.
3. Disconnect the Fluke Pressure Module and push  to turn the Fluke 718 off.

Calibration

Re-calibration (obtaining new cal-constants) is required only if a calibrator fails verification. Always re-verify after a re-calibration.

Note

Throughout this section, the 71X Calibrator may be referred to as the “UUT” (unit under test).

Preparing for Calibration

To prepare for calibration, do the following:

1. Make sure fuse(s) in the UUT are intact. By referring to Table 29, you should not have to open the unit.
2. Make sure you have the required test equipment available. (Refer to Table 30.)
3. Turn on and warm up the test equipment for the time required.
4. Allow UUT to come to ambient temperature. Turn it on and allow 5 minutes for warm-up of the UUT.

712 Calibration (V1.1 and Earlier)

Millivolts Measure

1. Hold down the $\boxed{\text{RTD TYPE}}$ and the $\boxed{^{\circ}\text{C}/^{\circ}\text{F}}$ key at the same time, then press and release the Ⓢ key.
2. When the display momentarily shows CAL , release both the $\boxed{\text{RTD TYPE}}$ and the $\boxed{^{\circ}\text{C}/^{\circ}\text{F}}$ keys. This puts the 712 into Cal Mode. The 712 should display:
INPUT 0.00 mV
3. Connect the test lead from the NORMAL jacks of the Fluke 5520A to the INPUT jacks (two middle jacks) on the 712 Calibrator (black to black, red to red).
4. Set the Fluke 5520A to 0.0000 mV and press $\boxed{\text{OPR}}$.
5. Press any key on the 712 Calibrator. The display should read:
INPUT ---- mV
then change to:
INPUT 0.00 mV
6. Press any key on the 712 Calibrator. The display should read:
INPUT ---- mV
then change to:
INPUT 160.00 mV
7. Set the Fluke 5520A to 160.0000 mV.
8. Press any key on the 712 Calibrator. The display should read:
INPUT ---- mV
then change to:
INPUT 320.00 mV
9. Set the Fluke 5520A to 320.0000 mV.
10. Press any key on the 712 Calibrator. The display should read:

INPUT ----- mV

then change to:

INPUT 640.00 mV

11. Set the Fluke 5520A to 640.000 mV.

12. Press any key on the 712 Calibrator. The display should read:

INPUT ----- mV

then change to:

INPUT 1280.00 mV

13. Set the Fluke 5520A to 1280.000 mV.

14. Press any key on the 712 Calibrator. The display should read:

INPUT ----- mV

then change to:

INPUT 400.00 R 4W

Resistance Measure

1. Connect two additional test leads from the NORMAL jacks of the 5520A to the 712 Calibrator (black wire to the 712 red jack labeled [3W NC] and red wire to the red jack labeled [4W NC]). All four input jacks of the 712 should now be in a 4-wire ohms measurement configuration.

2. Set the Fluke 5520A to 400.00 Ω and press **OPR**.

3. Press any key on the 712 Calibrator. The display should read:

INPUT ----- R 4W

then change to:

INPUT -----

mA Measure

1. Disconnect all four test leads from the Fluke 5520A and the 712 Calibrator.

2. Connect the two test leads from the AUX jacks on the Fluke 5520A to the middle jacks on the 712 Calibrator (black to black; red to red).

5. Press any key on the 712 Calibrator. The display will change to:

INPUT 0.00 mA

6. Set the Fluke 5520A to 0.00000 mA and press **OPR**.

7. Press any key on the 712 Calibrator. The display should read:

INPUT ----- mA

then change to:

INPUT 0.00 mA

8. Again, press any key on the 712 Calibrator, still with a 0.00000 mA input from the Fluke 5520A. The display should read:

INPUT ----- mA

then change to:

INPUT 2.000 mA

9. Set the Fluke 5520A to 2.00000 mA.

10. Press any key on the 712 Calibrator. The display should read:

INPUT ----- mA

then change to:

INPUT 0.500 mA

11. Set the Fluke 5520A to 0.50000 mA.

12. Press any key on the 712 Calibrator. The display should read:

INPUT ----- mA

13. Press any key on the 712 Calibrator and the unit will automatically reset itself, with all segments momentarily being displayed. Calibrator is now out of CAL mode. Press the \odot key to turn the calibrator off and disconnect all test leads.

712 Calibration (V1.2 and Later)

1. Hold down $\boxed{\text{RTD}}$ and $\boxed{\text{C/F}}$ while turning the power on.

2. Hold the two keys until CAL is displayed, then release the two keys. The display should read:

INPUT 15 Ω

3. Connect the two test leads from the NORMAL jacks of the 5520A to the INPUT jacks (two middle jacks) on the 712 Calibrator (black to black, red to red).

4. Connect two additional test leads, also from the NORMAL jacks of the 5520A, to the 712 Calibrator (black wire to the 712 red jack labeled [3W NC] and red wire to the red jack labeled [4W NC]). All four input jacks of the 712 should now be configured in a 4-wire ohm measurement.

5. Set the Fluke 5520A to 15 Ω and press $\boxed{\text{OPR}}$.

6. Press $\boxed{\text{C/F}}$. The display should read:

INPUT ----- Ω ,

then change to:

INPUT 350 Ω

7. Set the Fluke 5520A to 350 Ω .

8. Press $\boxed{\text{C/F}}$. The display should read:

INPUT ----- Ω

then change to:

INPUT 500 Ω .

9. Set the Fluke 5520A to 500 Ω .

10. Press $\boxed{\text{C/F}}$. The display should read:

INPUT ----- Ω

then change to:

INPUT 3200 Ω

11. Set the Fluke 5520A to 3200 Ω .

12. Press $\boxed{\text{C/F}}$. The display should read:

INPUT ----- Ω .

then change to:

OUTPUT 17-50 Ω .

13. Using four test leads, connect the four jacks of Fluke/Wavetek 1281 (Ω Sense 'Hi & Lo' and Input 'Hi & Lo') to the two middle jacks of the 712 Calibrator (black to black; red to red). This puts the Fluke/Wavetek 1281 in a 4-wire configuration.
14. Set the 3458A to the 1000 Ω range.
15. Press and until the 712 display matches the Fluke/Wavetek 1281.
16. Press . The display should read:
OUTPUT ----- Ω
then change to:
OUTPUT 350.00 0.
17. Press and until the 712 display matches the Fluke/Wavetek 1281.
18. Press . The display should read:
OUTPUT ----- Ω
then change to:
OUTPUT 126.00 Ω
19. Put the Fluke/Wavetek 1281 in the 10 k Ω range.
20. Press and until the 712 display matches the Fluke/Wavetek 1281.
21. Press . The display should read:
OUTPUT ----- Ω
then change to:
OUTPUT 2535.0 Ω
22. Press and until the 712 display matches the Fluke/Wavetek 1281.
23. Press . The display should read:
OUTPUT ----- Ω
then the unit will reset.
24. Press the power key to turn the unit off and disconnect the test leads.

713 Calibration

mA Measure Measure

1. On the 713 Pressure Calibrator hold down both the **[UNITS]** and **[DAMP]** keys. Press and release the **[⊙]** key.
2. When the display momentarily shows CAL, release the **[UNITS]** and the **[DAMP]** keys. This puts the 713 into Cal Mode. The 713 should display:

CAL 0.000 mA

3. Connect the test leads from the AUX jacks of the Fluke 5520A to the mA jacks on the 713 Calibrator (black to black and red to red).
4. Set the Fluke 5520A to 0.00000 mA and press **[OPR]**.
5. Press any key on the 713 Calibrator. The display should read:

----- 0.000 mA

then change to:

CAL 24.000 mA

6. Set the Fluke 5520A to 24.0000 mA.
7. Press any key on the 713 Calibrator. The display should read:

----- 24.00 mA

then change to:

rAnGE

Pressure Measure

The 713 Pressure Calibrators have built-in temperature compensation. Instruments being calibrated should be in a stable temperature environment for several minutes before calibration. Calibration facilities should be maintained near 23 °C nominal.

Re-calibration (re-characterization) is performed in terms of ‘psi’ pressure units. Inputs using other pressure units (ie. kPa and bar) must be mathematically converted.

1. Remove two-wire test lead from the 713 Calibrator and carefully attach the pressure fitting of the deadweight tester to the *pressure* jack on the 713 Calibrator.

Note

The use of TEFLON tape at the pressure fittings strengthens the seal.

At this point, the display should be indicating “rAnGE”. This is an indication to choose the correct model of the 713 Calibrator.

2. For 713 30G, press the **[MIN]** key. For 713 100G, press the **[MAX]** key. The display will flash for a short time:

----- rAnGE

then display:

CAL 0.00 PSI

3. Vent the system to ambient air to ensure 0.00 PSI.
4. Press any key on the 713 Calibrator. The display will change to read:

CAL ----- PSI

then change to:

CAL 30.000 PSI

or

CAL 100.00 PSI

depending on which model /range was selected in step 2.

5. Set up the deadweight tester for either 30 PSI or 100 PSI to be injected into the pressure port of the 713 Calibrator.
6. Once the pressure has stabilized, press any key on the 713 Calibrator. The display should read:

CAL ----- PSI

then change to:

CAL 15.000 PSI

or

CAL 50.00 PSI

depending on which model /range was previously selected.

7. Set the deadweight tester for either 15 PSI or 50 PSI.
8. Once the pressure has stabilized, press any key on the 713 Calibrator. The display should read:

CAL ----- PSI

then change to:

0.000mA XX.xx PSI (where XX.xx is the applied pressure)

If the display reads CALU, continue to step 9. Otherwise, the 713 Calibrator is no longer in CAL mode, skip to step 11.

9. Press to go to vacuum calibration. (Pressing any other key will end the calibration.) If you chose to calibrate vacuum, the display should read:

CAL -12.000 PSI

10. Apply -12 PSI, wait for the vacuum standard to stabilize, then press any key. The display should show:

11. The unit will then reset power. The 713 is now out of the CAL mode and in the normal mode of operation. Vent all pressure/vacuum.

714 Calibration

Temperature Measure

1. On the 714 Calibrator press and hold the $\boxed{\text{TC}}$ and $\boxed{\text{TYPE}}$ keys, then turn on the 714 by pressing and releasing the $\text{\textcircled{C}}$ key.
2. When the display momentarily shows CAL, release both the $\boxed{\text{TC}}$ and $\boxed{\text{TYPE}}$ keys. This puts the 714 into the Cal Mode. The 714 should display:
INPUT 0.00 mV
3. Connect the two-wire copper test lead (banana jacks to mini-connector) from the NORMAL jacks of the Fluke 5520A to the TC jack on the 714 Calibrator, observing correct polarity.

Note

Copper wire must be used during this step.

4. Set the Fluke 5520A to 0.0000 mV and press $\boxed{\text{OPR}}$.
5. Press any key on the 714 Calibrator. The display should read:

INPUT ----- mV

then change to:

INPUT 77.00 mV

6. Set the Fluke 5520A to 77.0000 mV.
7. Press any key on the 714 Calibrator. The display should read:

INPUT ----- mV

then change to:

OUTPUT mV

Temperature Source

1. Remove the copper test lead from the 714 Calibrator.
2. Press any key on the 714 Calibrator. The display should read:

OUTPUT ----- mV

After a few seconds, the display should change to:

TYPE J 0.0 °C

Thermocouple Block Calibration

1. Connect the Type-J thermocouple test lead from the TC jack on the Fluke 5520A to the TC jack on the 714 Calibrator, observing correct polarity.

Note

Type-J thermocouple wire (not copper) must be used.

2. Set the Fluke 5520A to source Type-J thermocouple at 0.0 °C. Press $\boxed{\text{OPR}}$.
3. Press any key on the 714 Calibrator. The display will very quickly flash:

TYPE J ----- °C

then read:

TYPE J HOLD °C

4. Wait for three to five minutes. The longer the waiting period, the more accurate the Thermo-block calibration will be.
5. Press any key on the 714 Calibrator. The display should read:
TYPE J ----- °C
then change to:
TYPE J 0.xx °C
This number represents the absolute error of the "CJC" sensor and should be below 1°C.
6. Press any key on the 714 Calibrator. The 714 should reset itself, displaying all segments momentarily. The display should then change to:
INPUT xx.x °C
where xx.x is some variable number; or OL (overload) may be indicated.
7. Press the © key to turn the calibrator off and remove the Type J thermocouple test lead.

715 Calibration

mA/Volts Measure

1. On the 715 Calibrator, hold down the $\frac{V}{mV}$ and the $\frac{mA}{\%}$ keys at the same time, then press and release the Ⓢ key.
2. When the display momentarily shows CAL , release the $\frac{V}{mV}$ and the $\frac{mA}{\%}$ keys. After CAL shows momentarily, the 715 will display:

INPUT 0.000 mA

3. Connect two test leads from the AUX jacks of the Fluke 5520A to the middle mA input jacks on the 715 Calibrator (black to COM jack and red to mA jack).
4. Set the Fluke 5520A to 0.00000 mA and press $\overline{\text{OPR}}$.
5. Press any key on the 715 Calibrator. The display should read:

INPUT ----- mA

then change to:

INPUT 24.000 mA

6. Set the Fluke 5520A to 24.0000 mA.
7. Press any key on the 715 Calibrator. The display should read:

INPUT ----- mA

then change to:

INPUT 0.000 V

8. Connect test lead from the NORMAL output jacks of the Fluke 5520A to the voltage jacks on the 715 Calibrator (black to COM jack and red to the V jack).
9. Set the Fluke 5520A to 0.0000 mV and press $\overline{\text{OPR}}$.
10. Press any key on the 715. A relay will click and the display should read:

INPUT ----- V

then change to:

INPUT 10.000 V

11. Set the Fluke 5520A to 10.00000 V.
12. Press any key on the 715 Calibrator. The display should read:

INPUT ----- V

then change to:

INPUT 0.00 mV

13. Set the Fluke 5520A to 0.0000 mV.
14. Press any key on the 715 Calibrator. The display should read:

INPUT ----- mV

then change to:

INPUT 100.00 mV

15. Set the Fluke 5520A to 100.0000 mV.
16. Press any key on the 715 Calibrator. The display should read:

INPUT ----- mV

then change to:

OUTPUT mV

mA/Volts Source Measure

1. Remove all test leads from the 715 Calibrator.
2. Press any key on the 715 Calibrator. Display should change to:
OUTPUT ---- mV
After a couple of seconds, display should change to:
OUTPUT ---- V
After a couple more seconds, display should change to:
OUTPUT mA
3. Take one single test lead and plug one end into the *V* jack and the other end into the *+LOOP* jack of the 715 Calibrator (places a short between the two jacks).
4. Press any key on the 715 Calibrator. Display should read:
OUTPUT ---- mA
5. The 715 will then reset itself with all segments momentarily being displayed, then change to:
OUTPUT 0.0000 V

The 715 is now out of the CAL mode. Turn the green Ⓢ key to turn the calibrator off.

716 Calibration

mA Measure

1. Hold down the **UNITS** and the **DAMP** keys at the same time, then press the green **Ⓢ** key. When the display shows CAL momentarily, release the **UNITS** and the **DAMP** keys immediately. After CAL shows, the display will automatically read:

CAL 0.000mA

2. Connect the test leads from the AUX jacks of the Fluke 5520A to the mA jacks on the 716 Calibrator (Black to Black and Red to Red).
3. Set the Fluke 5520A to 0.00000 mA and press the **OPR** key.
4. Press any key on the 716 Calibrator. The display should change to:

----- 0.000mA

then to:

CAL 24.000mA

5. Set the Fluke 5520A to 24.0000 mA.
6. Press any key on the 716 Calibrator. Display should change to:

----- 24.000mA

The unit will reset itself. All segments will be displayed momentarily and change to:

----- mA

7. Turn the green **Ⓢ** power key OFF and push the **STBY** key on the Fluke 5520A.

717 Calibration

mA Measure

1. Hold down the **[UNITS]** and the **[DAMP]** keys at the same time, then press the green **[Ⓢ]** key. When the display shows CAL momentarily, release the **[UNITS]** and the **[DAMP]** keys immediately. After CAL shows, the display will automatically read:

CAL 0.000mA

2. Connect the test leads from the AUX jacks of the Fluke 5520A to the mA jacks on the 717 Calibrator (Black to Black and Red to Red).
3. Set the Fluke 5520A to 0.00000 mA and press the **[OPR]** key.
4. Press any key on the 717 Calibrator. The display should change to:

----- 0.000mA

then to:

CAL 24.000mA

5. Set the Fluke 5520A to 24.0000 mA.
6. Press any key on the 717 Calibrator. Display should change from:

----- 24.000mA

to:

rAnGE

Pressure Measure

1. Remove test leads from the 717 Calibrator and carefully attach the pressure fitting to the *pressure* jack on the 717 Calibrator.

Note

The use of TEFLON tape at the pressure fittings strengthens the seal.

2. For the 717 100G press the **[MAX]** key. For the 717 30G, press the **[MIN]** key. The display will flash for a short time:

----- rAnGE

then display:

CAL 0.00 PSI

3. Vent the system to ambient air to ensure 0.00 PSI.
4. Press any key on the 717 Calibrator. The display will change to read:

CAL ----- PSI

then depending on the model selected in step 2, change to either:

CAL 30.000 PSI

or

CAL 100.00 PSI

5. Set up the deadweight tester for 30 PSI (or 100 PSI) to be injected into the pressure port of the 717 Calibrator.
6. Once the pressure has stabilized, press any key on the 717 Calibrator. The display should read:

CAL ----- PSI

then depending on the model selected in step 2, change to either:

CAL 15.000 PSI

or

CAL 50.000 PSI

7. Set the deadweight tester for 15 PSI (or 50 PSI) to be injected into the pressure port of the 717 calibrator.
8. Once the pressure has stabilized, press any key on the 717 Calibrator. The display should read:

CAL ----- PSI

then the calibrator will be out of CAL mode and in OPERATE mode. The display should read:

0.000mA XX.xx PSI (where XX.xx is the applied pressure)

If the display reads CALU, continue to step 9. If the 717 Calibrator is no longer in CAL mode, skip to step 11.

9. Press to go to vacuum calibration. (Pressing any other key will end the calibration.) If you chose to calibrate vacuum, the display should read:

CAL -12.000 PSI

10. Apply -12 PSI, wait for the vacuum standard to stabilize, then press any key. The display should show:

11. The unit will then reset power. The 717 is now out of the CAL mode and in the normal mode of operation. Vent all pressure/vacuum.

718 Calibration

mA Measure

1. On the 718 Pressure Calibrator hold down both the **[UNITS]** and **[DAMP]** keys. Press and release the **[⊙]** key.
2. When the display momentarily shows CAL, release the **[UNITS]** and the **[DAMP]** keys. This puts the 718 into Cal Mode. The 718 should display:
CAL 0.000 mA
3. Connect the test leads from the AUX jacks of the Fluke 5520A to the mA jacks on the 718 Calibrator (black to black and red to red).
4. Set the Fluke 5520A to 0.00000 mA and press **[OPR]**.
5. Press any key on the 718 Calibrator. The display should read:
---- 0.000 mA
then change to:
CAL 24.000 mA
6. Set the Fluke 5520A to 24.0000 mA.
7. Press any key on the 718 Calibrator. The display should read:
---- 24.00 mA
then change to:
rAnGE

Pressure Measure

The 718 Pressure Calibrators have built-in temperature compensation. Instruments being calibrated should be in a stable temperature environment for several minutes before calibration. Calibration facilities should be maintained near 23 °C nominal.

Re-calibration (re-characterization) is performed in terms of ‘psi’ pressure units. Inputs using other pressure units (ie. kPa and bar) must be mathematically converted.

1. Remove two-wire test lead from the 718 Calibrator and carefully attach the pressure fitting of the deadweight tester to the *pressure* jack on the 718 Calibrator.

Note

The use of TEFLON tape at the pressure fittings strengthens the seal.

2. At this point, the display should be indicating “rAnGE”. This is an indication to choose the correct model of the 718 Calibrator.

For 718 30G, press the **[MIN]** key. For 718 100G, press the **[MAX]** key. The display will flash for a short time:

----- rAnGE

then display:

CAL 0.00 PSI

3. Vent the system to ambient air to ensure 0.00 PSI.
4. Press any key on the 718 Calibrator. The display will change to read:

CAL ----- PSI

then change to:

CAL 30.000 PSI

or

CAL 100.00 PSI

depending on which model /range was selected in step 2.

5. Set up the deadweight tester for either 30 PSI or 100 PSI to be injected into the pressure port of the 718 Calibrator.

Once the pressure has stabilized, press any key on the 718 Calibrator. The display should read:

CAL ----- PSI

then change to:

CAL 15.000 PSI

or

CAL 50.00 PSI

depending on which model /range was previously selected.

6. Set the deadweight tester for either 15 PSI or 50 PSI.
7. Once the pressure has stabilized, press any key on the 718 Calibrator. The display should read:

CAL ----- PSI

then change to:

CALU

8. Release pressure by venting the system.
9. Press the **[MIN]** key to go to vacuum calibration. Otherwise, press any key to finish calibration. If calibrating vacuum, the display should show:

CAL -12.000 PSI

10. Make sure the pressure/vacuum switch is in the vacuum position. Forward (clockwise) is for pressure and backward (counter-clockwise) is for vacuum.
11. Set up the deadweight tester to apply -12.000 PSI.
12. Wait for the pressure standard to stabilize, then press any key.
13. The display should show:

14. The unit will then reset power.
15. The 718 Calibrator is now out of the CAL mode and into the normal mode of operation. Carefully vent all pressure, press the **Ⓢ** key to turn the calibrator off, and disconnect all pressure fittings.

Replacement Parts

Table 54 lists the replaceable parts and accessories for the 71X Calibrators. (See Figure 6 for an exploded view of the 718 Calibrator.)

Note

Not all parts listed in Table 54 are shown in Figure 6.

Table 54. Replaceable Parts and Accessories

Item	Description	PN or Model No.	Used On	Qty.
A1	Assembly	690906 691147	718 30G 718 100G	1
BT1	9V battery, ANSI/NEDA 1604A or IEC 6LR61	614487	71X	1
BT2	9V battery, ANSI/NEDA 1604A or IEC 6LR61	614487	718	1
△F1	Fuse, 125 mA, 250V fast	686527	71X	1
△F2	Fuse, 125 mA, 250V fast	686527	715	1
H2,3,4	Case screw	832246	71X	3
H5,6	Battery door fasteners	948609	71X	2
H7,8	Bracket screw	641131	718	2
MP1	LCD Bezel	620242 620259 620267 620275 646866 664000 663997 1638728 664158 664169	712 713 30G 713 100G 714 714 716 717 30G 717 100G 718 30G 718 100G	1
MP2	LCD	686490 686482	712,714,715 713,716,717, 718	1
MP6	Pump Assembly	691383	718	1
MP7,8	Selector knob	664193	718	2
MP9	Vernier adjust knob	664190	718	1
MP10	Pump handle knob	664185	718	1
MP11,12,13	O-ring, for pressure input	146688	713,717,718	1
MP14	Spacer for pressure input	687449	713,717,718	1
MP20	Shield, LCD, Top Case	687092	71X	1
MP21	LCD Zebra Strip	643376	71X	2
MP22	O-ring for input/output receptacle	831933	712,715	1
MP85	Case top	620192 620218 620226 620234 620200 69091 690997 1640322 690997 691147	712 713 30G 713 100G 714 715 716 717 30G 717 100G 718 30G 718 100G	1
MP86	Case bottom	620168 664174	71X 718	1
MP89, 90	Non-skid foot	824466	71X	2
MP92	Battery door	609930 664177	71X 718	1
S1	Keypad	687084 687068 687076 687100	712 713,716,717 714 715	1

Table 54. Replaceable Parts and Accessories (cont)

Item	Description	PN or Model No.	Used On	Qty.
TM1	712 Instruction Sheet	650280	712	1
	713 Instruction Sheet	650298	713	
	714 Instruction Sheet	560306	714	
	715 Instruction Sheet	650314	715	
	716 Instruction Sheet	690008	716	
	717 30G/100G Instruction Sheet	690013	717	
	718 30G/100G Users Manual (on CD)	1549626	718	
-	Holster, yellow	664182	718	1
-	Test lead, red	688051	712	2
-	Test lead, black	688066	712	2
ACCESSORIES				
AC70A	Alligator Clips	AC70A	713 715 718	1
CG81Y	Holster, Yellow	CG81Y	71X	1
TL20	Industrial Test Lead Set	TL20	713 715 716 717	Option
TL75	Test lead set	TL75	713 715 716 717	1
TM2	71X Series Calibration Manual	686540	71X	Option
Parts are for all 71X Calibrators unless specified. ⚠ For safety, use exact replacement only.				

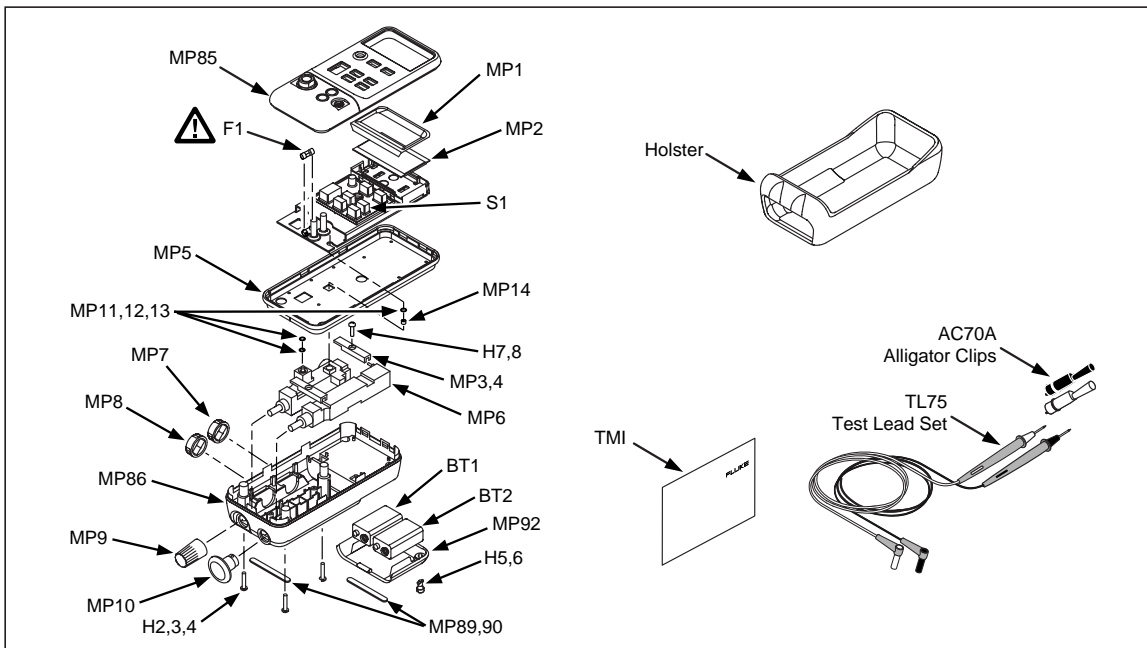

Figure 6. Exploded View (718 shown)

wh004.eps