

CP68, 2280 & 2290 Series

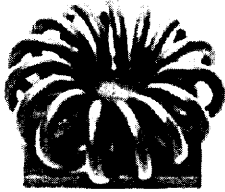

CP-68

MODEL	DIM. A MM (INCHES)	R _θ (°C/W)	MODEL	DIM. A MM (INCHES)	R _θ (°C/W)
CP68	-----	21.7	2292B	28.58 (1.125)	23.4
2283B	-----	32.6	2296B	-----	18.8
2286B	-----	32.6	2297B	31.75 (1.250)	17.9
2288B	25.40 (1.000)	25.9	2298B	38.10 (1.500)	16.3



▲ CP68

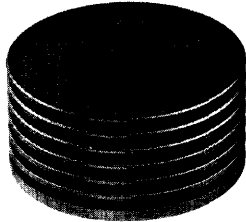

▲ 2296B

▼ 2296

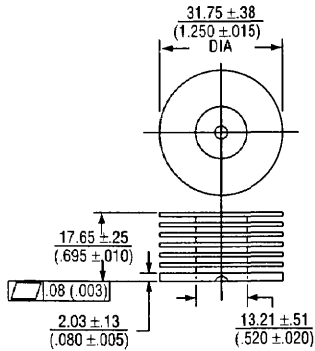

▼ 2297, 2298

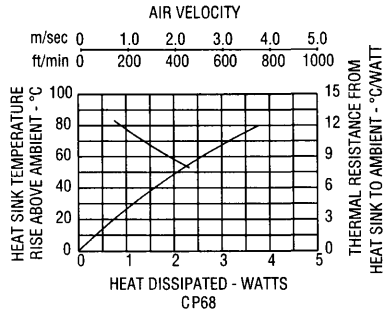
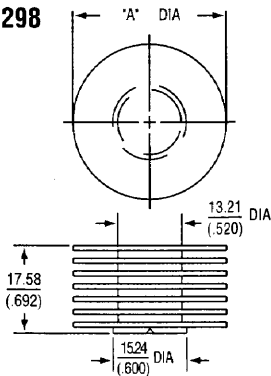

▼ CP68

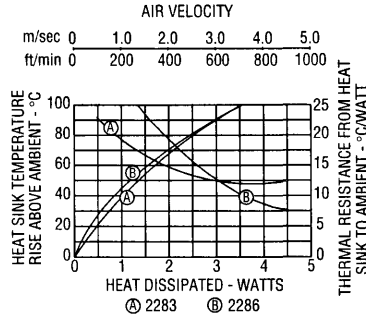
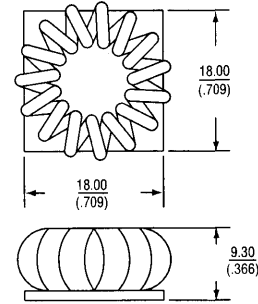

▼ 2283

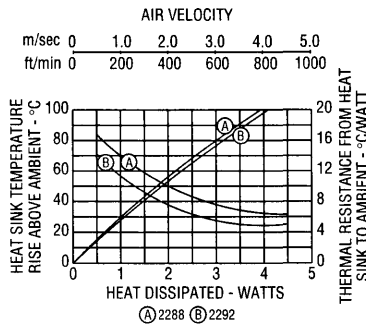
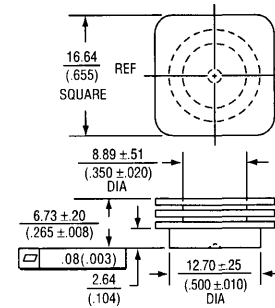

▼ 2286

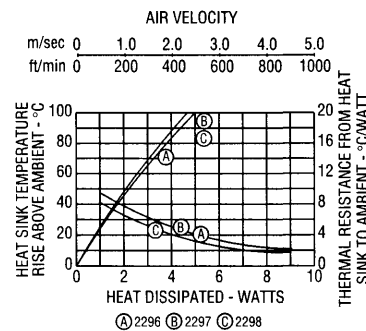
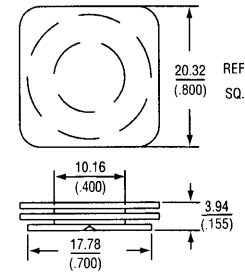

▼ 2288, 2292

