

E/148000/* Electromechanical rodless tooth belt actuator with or without servo motor



- > □48 ... 100 mm
- > Robust construction
- > High performance internal guiding
- > Reliable performance
- > Long life
- > Servo motors
- > Different feedback systems available
- > Holding brake available
- > Drives available with EtherCAT, PROFINET, PROFIBUS, EtherNet/IP, DeviceNet & CANopen communications



Technical features

Function:

Actuator with tooth belt; with or without servo motor

Actuator size □:

48, 60, 80, 100 mm

Strokes:

Available 100 ... 5500 mm (short strokes < 100 mm on request)

Speed:

max. 10 m/s

Forces F_{max} :

1500 N (thrust force)

Motor data

Voltage:

400 VAC

Rated current:

0,7 ... 9 A

Power:

0,16 ... 2,2 kW

Drive data

Voltage:

400 VAC

Rated current:

3,0 ... 10,5 A

Output power:

0,75 ... 4,0 kW

Duty cycle:

100 %

Temperature:

Operating temperature actuator only:
-20 ... 80 °C (-4 ... 176 °F)

Ambient temperature:
Actuator:
-20 ... 80 °C (-4 ... 176 °F)

Motor:

0 ... 40 °C (32 ... 104 °F)

IP Protection rate motor only:

IP65

Standard Materials:

End covers: Die cast aluminum

Yoke, carriage, cover and barrel: Anodized aluminum

Cover strip: PA

Technical data

Actuator size □ (mm)	48	60	80	100
Tooth belt width (mm)	12	16	20	25
Incremental stroke (mm)	5	5	4	4
Axial clearance (mm)	0,2	0,2	0,45	0,45
Available velocity with standard Norgren servo motor, ratio 1:1 (m/s)	6,0	7,8	10,0	10,0
Max permissible velocity (m/s)	10,0	10,0	10,0	10,0
Max permissible rpm (1/min)	5000	3870	2880	2270
F max axial (kN)	0,2	0,5	1,0	1,5
Max. torque (Drive shaft) (Nm)	3,8	12,3	33,1	63,0
Order stroke (mm)*	100 ... 3000	100 ... 5500	100 ... 5500	100 ... 5500
Acceleration max (m/s ²)	10			

*Strokes < 100 mm on request

The function

The new Norgren ELION provides a high performance tooth belt actuator with servo motor. The actuator can easily be configured and ordered with the Norgren online tool:

<https://www.norgren.com/uk/en/technical-support/configurators>

or visit our landing page for more information:



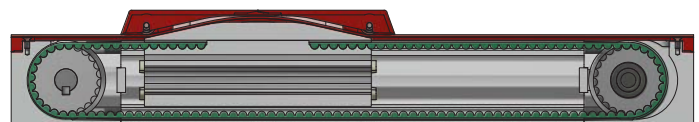

<https://www.norgren.com/uk/en/list/electric-actuators>



List of Content:

General rules	3
Actuator Variants	4
Communications of motors, drives and bus protocols	5
Option Selector	5
Sizing rules and formulas	6
Max. forces and moments	8
Unsupported length	9
Basic dimensions cylinders	10
Mountings and accessories	13
Servo Motors	15
Drives	19
Switches	20
Bus cards	24
Cable	24
Accessories for Drives	24

Norgren Family (Actuator ranges in the red frame are shown in this data sheet)

Picture	Function	Data sheet title	Data sheet number
	Electromechanical	E/809000/* Electromechanical actuator with or with or without servo motor	en 1.6.300
	Pneumatic	PRA/802000/M, RA/802000/M, RA/8000, RA/8000/M ISOLine™ 15552 cylinder, double acting	en 1.5.220
	Electromechanical	E/149000/* Electromechanical rodless spindle actuator with or without servo motor	en 1.6.400
	Electromechanical	E/148000/* Electromechanical tooth belt actuator with or without servo motor	en 1.6.500
	Pneumatic	M/146000, M/146100, M/146200, LIN-TRA®PLUS rodless cylinder Magnetic & Non-magnetic piston, double acting	en 1.6.009



Rules

The Norgren ELION series E/148000 rodless electric actuator is a combination of a tooth belt drive actuator and an electric servo motor. Therefore, it must be ensured that the system design, installation, commissioning/start-up and maintenance are carried out by personnel who have the necessary training and competence. They must read the safety information and I&M guide carefully. The actuator must not be used as a mechanical stop. A safety stroke should be considered. For further information, please refer to the comments and drawing on page 7.

Operating conditions

The actuator can perform multiple linear positioning tasks. To prevent damage of the internal guiding system, lateral forces and torque values must be kept within the specifications given in this document. Impact load on the carriage and housing must also be avoided to prevent damage on the tooth belt and bearings. Mechanical impact on the cover band must be avoided.

Actuator sizing

Tooth belt drive actuators like the Norgren ELION are complex mechanical systems transferring the rotational movement of an electric motor into a linear motion. Please be advised that the technical data presented on page 1 may vary for different applications. For exact sizing, please refer to page 6 ... 7, use the Norgren online configurator or contact our technical service.

Motor

The sizing of the motor depends on the load cycle applied to the actuator. At all times, the maximum torque requirements must stay below the intermittent torque the motor can apply. To prevent overheating of the motor, the mean torque demand must be below the continuous torque of the motor. For exact sizing, please refer to page 6 ... 7, use the Norgren online configurator or contact our technical service.

Mechanical brake

The motors supplied by IMI Precision Engineering can be equipped with a mechanical holding brake. While both hardware and software are designed to high standards of quality and robustness, they are not intended for use as safety functions, i.e. where a fault or failure would result in a risk of injury.

Do not apply the brake while the motor shaft is rotating. The brake can only take a limited number of emergency braking operations and must not be used for repeated dynamic braking.

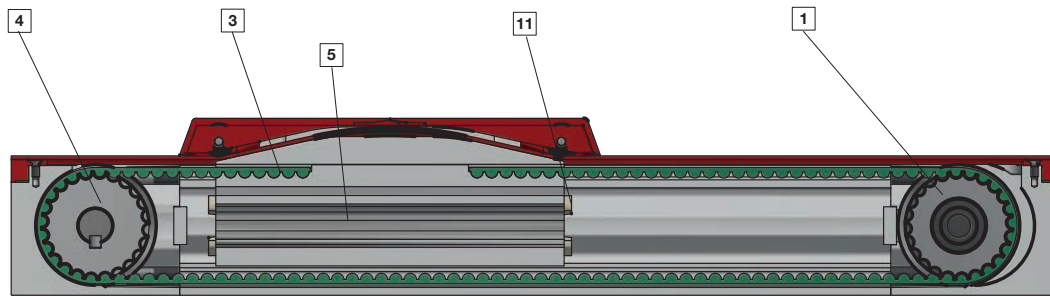

1	Pulley, loose end
2	Profile barrel
3	Toothed belt
4	Pulley, drive end
5	Yoke
6	Carriage
7	Motor
8	Switch and mounting groove
9	Power cable connector
10	Motor feedback cable connector
11	Internal guiding
12	Cover strip
13	Gear box

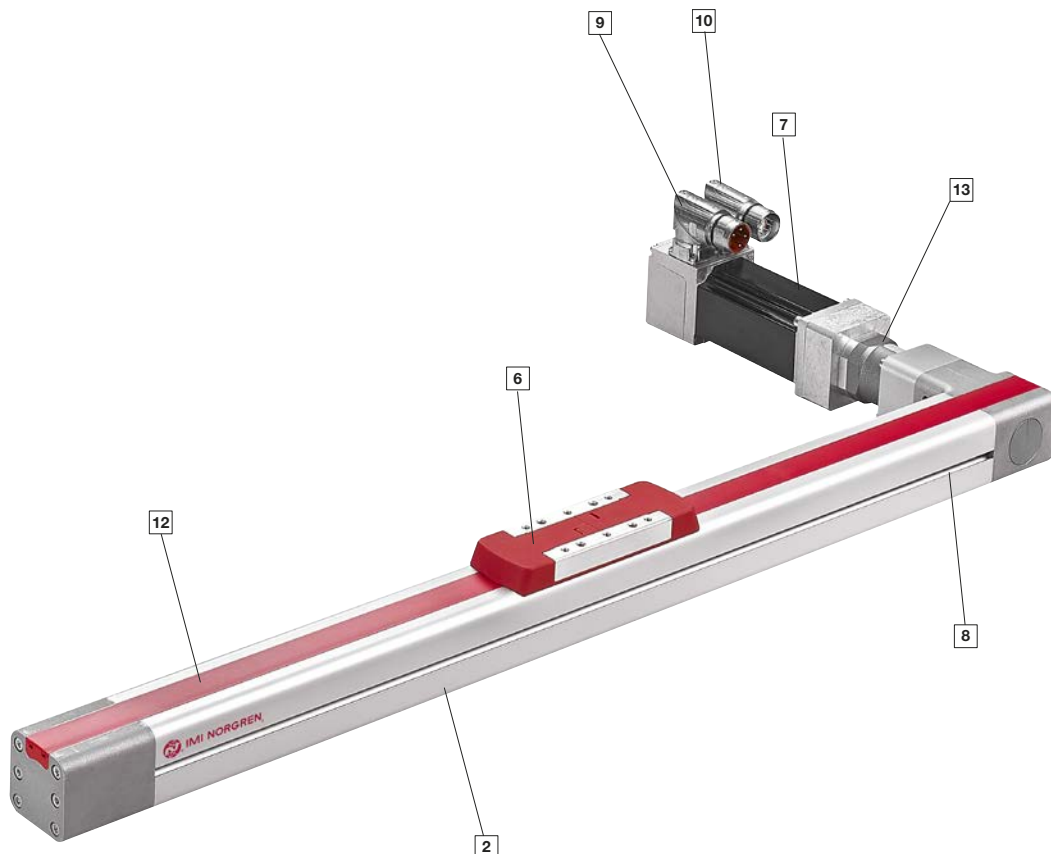

Actuator variants
E/148 ★ ★ ★ / ★ ★ ★ / ★ ★ ★ / ★ ★ ★ ★

Size Sub. 1	Motor / Gearbox orientation Sub. 2		Gear ratio Sub. 3	Motor Kit Sub. 4	Flange/Motor Sub. 5					Stroke (mm) Sub. 7		
	Right	Left			without brake, resolver without brake, absolute (Multi turn)		with brake, resolver with brake, absolute (Multi turn)					
□48 048	A	B	no 01	Actuator without coupling with housing for customer individual motor (see page 10)	B	No Motor	X	X				100 ... 3000 (stroke increment 5 mm)
			no 01	Actuator with coupling with housing for customer individual motor (see page 11)	C	No motor	08, 09, 10*					
			1:4 04	With motor kit (see page 12)	D	No motor, flange □55; ØN=40; ØM=63	X	1				
			1:7 07			Motor □55 (1,05 Nm)	E	A	B	M	N	
□60 060	A	B	no 01	Actuator without coupling with housing for customer individual motor (see page 10)	B	No Motor	X	X				100 ... 5500 (stroke increment 5 mm)
			no 01	Actuator with coupling with housing for customer individual motor (see page 11)	C	No motor	09, 14*					
			1:3 03	With motor kit (see page 12)	D	No motor, flange □55; ØN=40; ØM=63	X	1				
			1:5 05			No motor, flange □67; ØN=60; ØM=75	E	2				
			1:7 07			Motor □55 (1,05 Nm)	J	A	B	M	N	
□80 080	A	B	no 01	Actuator without coupling with housing for customer individual motor (see page 10)	B	No Motor	X	X				100 ... 5500 (stroke increment 4 mm)
			no 01	Actuator with coupling with housing for customer individual motor (see page 11)	C	No motor	14, 20*					
			1:3 03	With motor kit (see page 12)	D	No motor, flange □67; ØN=60; ØM=75	X	1				
			1:5 05			Motor □67 (2,45 Nm)	J	2				
			1:7 07			Motor □67 (3,50 Nm)	N	A	B	M	N	
□100 100	A	B	no 01	Actuator without coupling with housing for customer individual motor (see page 10)	B	No Motor	X	X				100 ... 5500 (stroke increment 4 mm)
			no 01	Actuator with coupling with housing for customer individual motor (see page 11)	C	No motor	14, 19, 20*					
			1:3 03	With motor kit (see page 12)	D	No motor, flange □67; ØN=60; ØM=75	X	1				
			1:5 05			No motor, flange □89; ØN=80; ØM=100	N	2				
			1:7 07			Motor □67 (3,50 Nm)	R	A	B	M	N	

* = individual Actuator shaft Ø mm on request

Communications of motors, drives and bus protocols

Bus Protocol - Option Module Card											Standard model drive	Description	Page
Symbol	□55	□67	□89	SI-PROFINET RTV2	SI-PROFIBUS	SI-EtherNet	SI-EtherCAT	SI-CANopen	SI-DeviceNet	SI-I/O			
	X	X									QE/D01400030	Standard drive with internal bus system (for motor size □55 - 67)	19
			X	X	X	X	X	X	X		QE/D02400105	Standard drive with internal bus system (for motor size □89)	

Option selector

E/148**/****/****/******

Actuator size □	Substitute 1		Order stroke (mm) **	Substitute 7
48	048		100 ... 5500	
60	060		Motor / Feedback / Brake	Substitute 6
80	080		Motor with resolver, without brake	A
100	100		Motor with absolute (Multi turn), without brake	B
Motor / Gearbox orientation	Substitute 2		Motor with resolver, with brake	M
Right	A		Motor with absolute (Multi turn), with brake	N
Left	B		No motor, no coupling, with housing	X
Gear ratio	Substitute 3		No motor, small flange	1
1:1 (no gear box)	01		No motor, big flange	2
1:3	03		Flange	Substitute 5
1:4	04		Flange for motor □55; 1,05 Nm	E
1:5	05		Flange for motor □67; 2,45 Nm	J
1:7	07		Flange for motor □67; 3,50 Nm	N
			Flange for motor □89; 6,90 Nm	R
			No motor	X
			(see Substitute 6 for flange) E/148****/****/?/****	
			↳ No motor, no coupling, with housing	X
			No motor, small flange	1
			No motor, big flange	2
			Motor kit	Substitute 4
			Actuator only, no coupling, with coupling housing	B
			Actuator only, with coupling, with coupling housing	C
			Use Sub. 5 & 6 for motor shaft diameter E/148****/****/C**/****	
			↳	08 ... 20
			e.g. 08 = 8 mm motor shaft	
			09 = 9 mm motor shaft	
			...	
			14 = 14 mm motor shaft	
			Actuator only, with coupling, with coupling housing, with motor flange	D

For combinations of cylinder variants consult our technical service.

This option selector explains only the cylinder variants.

Additional variants/options are not possible. Detail's see table on page 4.

**Strokes < 100 mm on request

Sizing Rules and Formulas for loading values

1. Definition of the load cycle

The load cycle includes all movements of the actuator. For every step, the following values must be defined:

- Direction of the movement
- Rotational position (alignment) of the carriage (top, side, down)
- End position of the movement
- External load mass
- Offset position of the center of gravity of the load mass in relation to the carriage
- Acceleration and deceleration
- Maximum velocity
- Constant external forces
- Offset position of the force application in relation to the carriage
- Possible pause times at the end of the movement

Alignment (Roll)

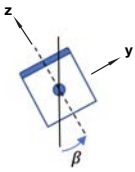

Direction (Pitch)

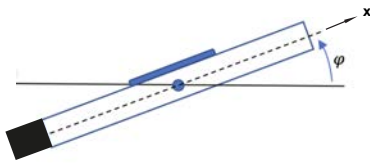

Due to the high positioning accuracy of the Norgren ELION actuators, the number of steps in one cycle is not limited.

2. Calculation of the forces and torques acting on the actuator

For a basic selection of the actuator, the knowledge of the acting forces during the load cycle is essential. For each movement of the load, all forces and torques acting on the actuator must be defined. This includes both external forces applied on the carriage and gravitational forces caused by the load mass applied.

2.1 Calculation of gravitational forces depending on alignment and direction

The Norgren ELION rodless actuator is equipped with an elaborated internal guiding system. To select the size of actuator fitting the application, all torques and forces acting on the bearings must be calculated.

As a first step, the gravitational forces caused by the load mass and the moving mass of the actuator are transformed into the actuator coordinate system:

$$F_{x,g,load} = -m_{load} \cdot g \cdot \sin(\varphi)$$

$$F_{x,g,act} = -m_{mov,act} \cdot g \cdot \sin(\varphi)$$

$$F_{y,g,load} = -m_{load} \cdot g \cdot \sin(\beta) \cdot \cos(\varphi)$$

$$F_{y,g,act} = -m_{mov,act} \cdot g \cdot \sin(\beta) \cdot \cos(\varphi)$$

$$F_{z,g,load} = -m_{load} \cdot g \cdot \cos(\beta) \cdot \cos(\varphi)$$

$$F_{z,g,act} = -m_{mov,act} \cdot g \cdot \cos(\beta) \cdot \cos(\varphi)$$

2.2 Calculation of torque and force values applied on the carriage

The total forces applied on the carriage are calculated as follows:

$$F_{x,a,load} = m_{load} \cdot a$$

$$F_{x,a,act} = m_{mov,act} \cdot a$$

$$F_{x,tot} = F_{x,g,load} + F_{x,a,act} + F_{x,a,load} + F_{x,a,act} + F_{x,ext}$$

$$F_{y,tot} = F_{y,g,load} + F_{y,a,act} + F_{y,ext}$$

$$F_{z,tot} = F_{z,g,load} + F_{z,a,act} + F_{z,ext}$$

The torque values applied are calculated using these forces together with the lever arms through the offset of both the Center of Gravity of the external load and the application point of the external forces:

$$F_{TB} = 1.2 \cdot F_{x,tot}$$

$$M_x = F_{z,g,load} \cdot \Delta y_{COG} + F_{z,ext} \cdot \Delta y_{ext} - F_{y,g,load} \cdot \Delta z_{COG} - F_{y,ext} \cdot \Delta z_{ext}$$

$$M_y = (F_{x,g,load} + F_{x,a,load}) \cdot \Delta z_{COG} + F_{x,ext} \cdot \Delta z_{ext} - F_{z,g,load} \cdot \Delta x_{COG} - F_{z,ext} \cdot \Delta x_{ext} - F_{TB} \cdot \Delta z_{TB}$$

$$M_z = F_{y,g,load} \cdot \Delta x_{COG} + F_{y,ext} \cdot \Delta x_{ext} - (F_{x,g,load} + F_{x,a,load}) \cdot \Delta y_{COG} - F_{x,ext} \cdot \Delta y_{ext}$$

The offset in z-direction must be corrected by the distance between the COG of the moving parts of the actuator and the top of the carriage

-> $z_{COG} = z_i + z_o$ using the following values for Δz_o . The torque applied by the tooth belt is calculated using the given values for Δz_{TB} .

Size	48	60	80	100
Δz_o	37 mm	47 mm	61,5 mm	75,5 mm
Δz_{TB}	191 mm	24,67 mm	33,1 mm	42 mm

To evaluate whether the forces and torques can be tolerated by the internal bearing system, they are normalised using the maximum tolerable values in every direction and then summarised. If the sum is ≤ 1 the bearing is sufficiently sized for the load:

$$\frac{|M_x|}{M_{x,max}} + \frac{|M_y|}{M_{y,max}} + \frac{|M_z|}{M_{z,max}} + \frac{|\sum_j F_{y,tot,j}|}{F_{y,max}} + \frac{|\sum_l F_{z,tot,l}|}{F_{z,max}} \leq 1$$

The maximum values $M_{x,max}$, $M_{y,max}$, $M_{z,max}$, $F_{y,max}$ and $F_{z,max}$ depend on the velocity of the movement and can be estimated using the diagrams on page 8.

a	Acceleration/deceleration	m/s ²
$m_{mov,act}$	Moving mass of the actuator	kg
m_{load}	Load mass applied on actuator	kg
$\Delta x, \Delta y, \Delta z$	Distance of forces/loads to actuator centre	m
β	Position of carriage	°
φ	Direction of movement	°
g	Gravitational acceleration	m/s ²

3. Selection of the actuator, motor and gear box

3.1 Selection of the actuator

The selection of the actuator is carried out based on the sizing of the internal bearing system. A sufficiently sized bearing system indicates a sufficiently sized actuator.

Additionally, the maximum thrust force necessary during the load cycle must be compared to the maximum force applicable to the actuator

$$F_{tot,max} < F_{max,actuator}$$

3.2 Selection of a motor and gear box

For each actuator, two motor sizes are available with different gear box ratios. The selection of the motor and gear box is based on the driving torque T rotational speed n of the actuator shaft which have to be calculated for each step of the load cycle.

$$T_{act,step} = 1,2 \cdot F_{x,tot,step} \cdot \frac{d_{pulley}}{2}$$

$$n_{act,step} = \frac{v_{max,step}}{d_{pulley} \cdot \pi}$$

Size	48	60	80	100
d_{pulley}	38,20 mm	49,34 mm	66,21 mm	84,03 mm

Using a gear box reduces the necessary motor torque whilst increasing the rotational speed of the motor. All values calculated must be below the intermittent torque the motor can deliver (diagr. pages 16 ... 18).

$$T_{mot} = \frac{T_{act}}{i_{gear}}$$

$$n_{mot} = n_{act} \cdot i_{gear}$$

T'_{act}	Torque at the actuator shaft	Nm
T'_{mot}	Output torque of the motor	Nm
n_{act}	Rotational speed of the actuator shaft	min-1
n_{mot}	Rotational speed of the motor shaft	min-1
$v_{max,step}$	Maximum velocity of each step	m/s

To avoid overheating of the motor, the mean torque $T_{mot,rms}$ of the load cycle must be lower than the continuous torque (diagr. pages 16 ... 18).

$$T_{mot,rms} = \sqrt{\sum \left[(T_{mot,step})^2 \cdot \frac{t_{step}}{t_{tot}} \right]}$$

$$n_{mot,rms} = \sqrt{\sum \left[(n_{mot,step})^2 \cdot \frac{t_{step}}{t_{tot}} \right]}$$

4. Additional mountings

To avoid bending of the actuator, the installation of additional mountings may be necessary. For each actuator size, the maximum unsupported length can be estimated with the forces in y- and z-direction using the diagrams on page 9.

5. Safety stroke

Disregarding the initial set up, the actuator must not touch its mechanical end stops. A safety stroke should be considered, respecting the

application boundaries and environments.

We generally recommend a safety stroke of 20 mm per side for electric rodless actuators. The order stroke = working stroke + safety stroke of

2 x 20 mm.

Please note, that during the initial set up, the actuator might exceed its nominal end position as given (over run "Dimension "X") in the drawing below.

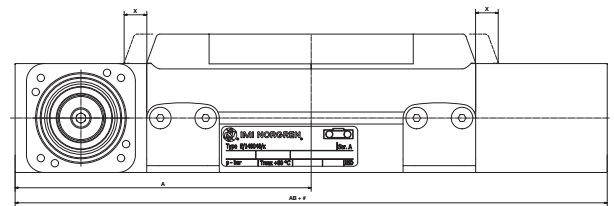

Dimension "X"

10 mm for size 48/60

12 mm for size 80/100

For more information please visit:

<https://www.norgren.com/uk/en/list/electric-actuators>

Max. forces and moments

E/148048

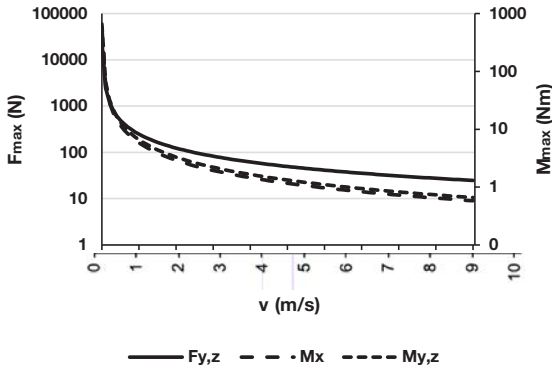

E/148060

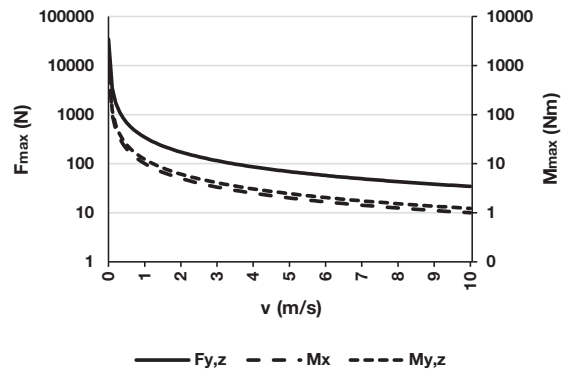

E/148080

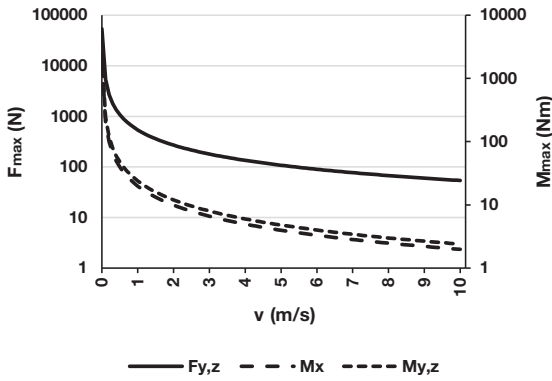

E/148100

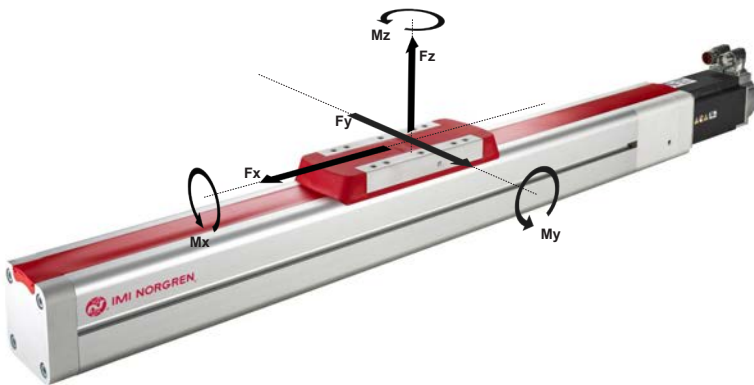
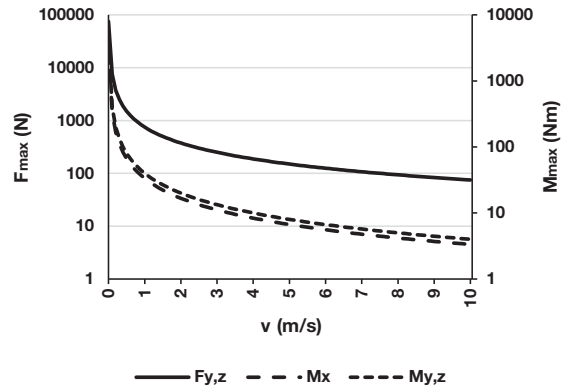

$$\frac{|M_x|}{M_{x,max}} + \frac{|M_y|}{M_{y,max}} + \frac{|M_z|}{M_{z,max}} + \frac{|\sum_j F_{y,tot,j}|}{F_{y,max}} + \frac{|\sum_l F_{x,tot,l}|}{F_{z,max}} \leq 1$$

Unsupported length

E/148048

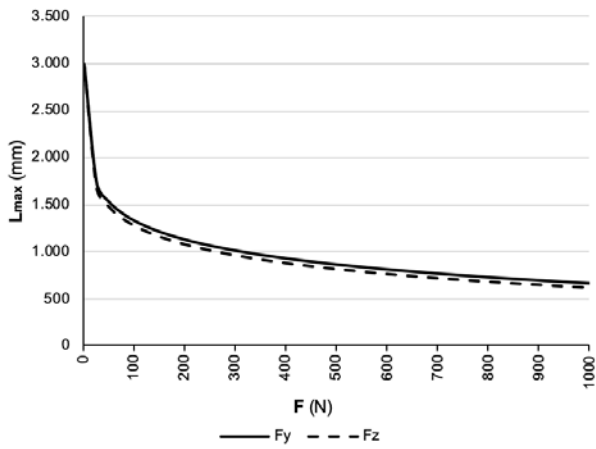

E/148060

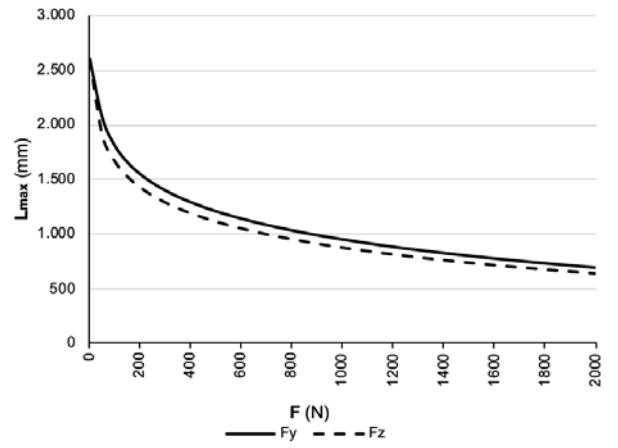

E/148080

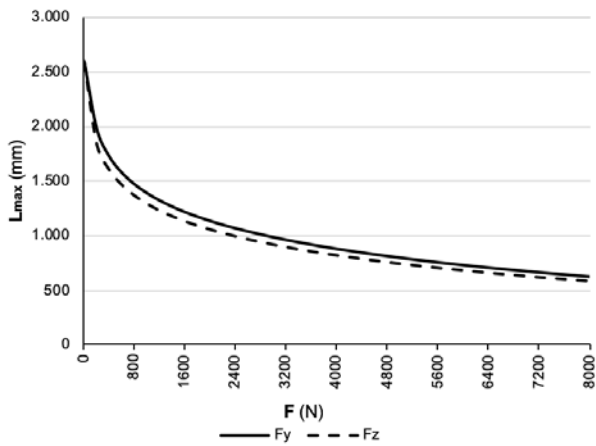

E/148100

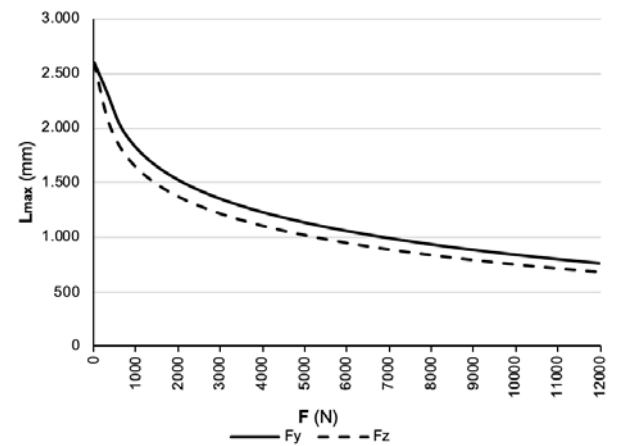

Basic dimensions E/148000/A01/CXX, E/148000/B01/CXX
Actuator with coupling with housing for customer individual motor

Dimensions in mm
 Projection/First angle



Shown variant E/148000/A*
Motor/ gear box orientation right

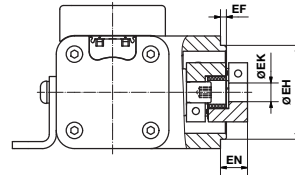
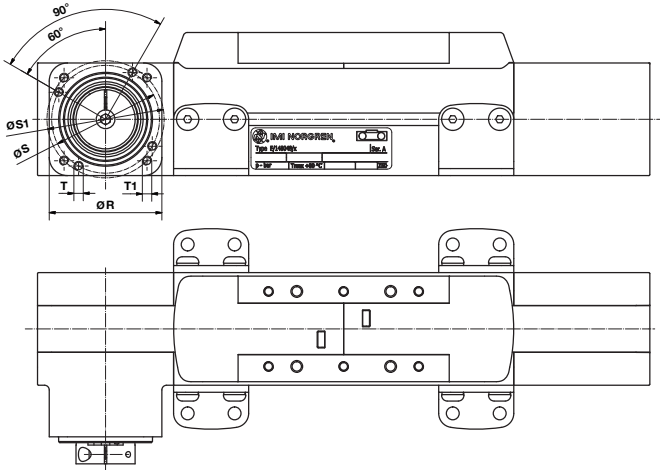

Size	EF	EH	EK	EN	R	S	S1	T	T1	Weight at 0 mm (kg)	Weight per 100 mm (kg)	Model
48	2.5	40 h7	8	11.5	48	46	50	M4-10,5 deep	M4-10,5 deep	1,65	0,3	E/148048/C08
48	2.5	40 h7	9	11.5	48	46	50	M4-10,5 deep	M4-10,5 deep	1,65	0,3	E/148048/C09
48	2.5	40 h7	10	11,5	48	46	50	M4-10,5 deep	M4-10,5 deep	1,65	0,3	E/148048/C10
60	2.5	50 h7	9	13	60	57	70	M5-13,5 deep	M5-13,5 deep	3,4	0,4	E/148060/C09
60	2.5	50 h7	14	13	60	57	70	M5-13,5 deep	M5-13,5 deep	3,4	0,4	E/148060/C14
80	2.5	66 h7	14	20	80	75	92	M6-12,5 deep	M6-12,5 deep	7,25	0,7	E/148080/C14
80	2.5	66 h7	20	20	80	75	92	M6-12,5 deep	M6-12,5 deep	7,25	0,7	E/148080/C20
100	2.5	80 h7	14	27	100	100	-	M6-15,5 deep	M6-15,5 deep	14	1,1	E/148100/C14
100	2.5	80 h7	19	27	100	100	-	M6-15,5 deep	M6-15,5 deep	14	1,1	E/148100/C19
100	2.5	80 h7	20	27	100	100	-	M6-15,5 deep	M6-15,5 deep	14	1,1	E/148100/C20

Basic dimensions E/148000/A01/D, E/148000/B01/D****
Actuator with motor kit (motor flange)

Shown variant E/148000/A*
 Motor/ gear box orientation right

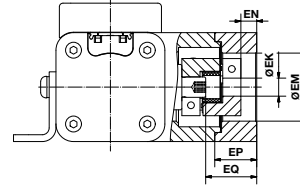
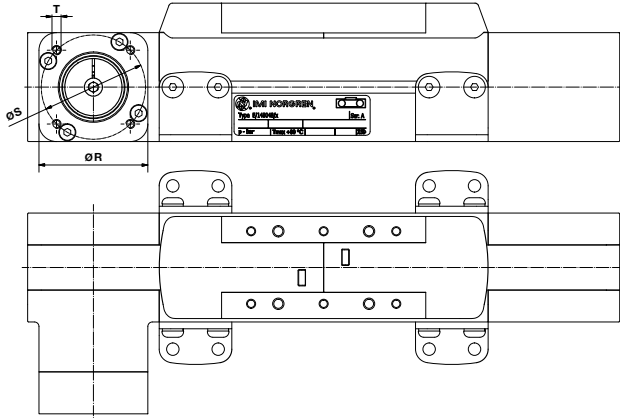

Motor kit without gear box/D**

Size	EK	EM	EN	EP	EQ	EZ	R	S	T	Weight without motor at 0 mm (kg)	Weight per 100 mm (kg)	Model
48	8	30 G7	12	23,5	27	-	48	46	M4/12 deep	2,2	0,3	E/148048/*01/DX1 E/148060/*01/DX1 E/148060/*01/DE*
60	9	40 G7	7	20	21	-	60	63	M5/12 deep	4,3	0,4	E/148080/*01/DX1 E/148080/*01/DJ* E/148080/*01/DN*
80	14	60 G7	7	27	36	-	80	75	M5/15 deep	8,4	0,7	E/148100/*01/DX1 E/148100/*01/DN*
100	14	60 G7	7	34	44	4	100	75	M5/17 deep	15,5	1,1	E/148100/*01/DX1 E/148100/*01/DN*

Shown variant E/148000/A*
 Motor/ gear box orientation right

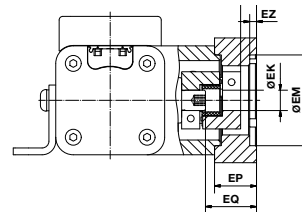
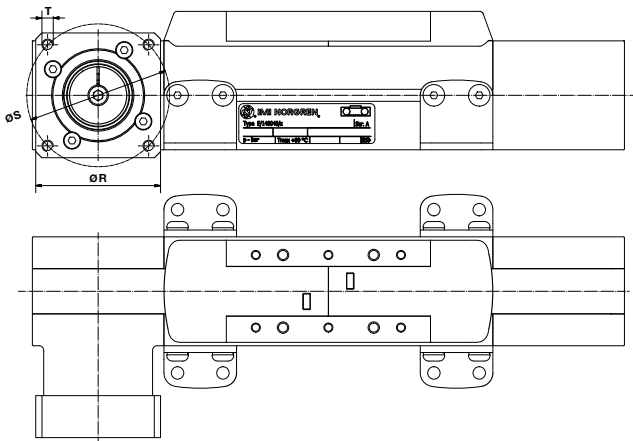

Motor kit without gear box/D**

Size	EK	EM	EN	EP	EQ	EZ	R	S	T	Weight without motor at 0 mm (kg)	Weight per 100 mm (kg)	Model
48	9	40 G7	7	18,5	22	3	55	63	M5/10 deep	3,35	0,3	E/148048/*01/DX2 E/148048/*01/DE*
60	14	60 G7	18,5	31,5	33	3	70	75	M5/15 deep	5,4	0,4	E/148060/*01/DX2 E/148060/*01/DJ* E/148100/*01/DX2
100	19	80 G7	7	34	44	-	100	100	M6/18 deep	17,3	1,1	E/148100/*01/DR* E/148100/*01/DN*

Basic dimensions E/148000/A0*/D, E/148000/B0*/D****
Actuator With motor kit (see page 12) and gear box

Dimensions in mm
 Projection/First angle



Shown variant E/148000/A*
Motor/ gear box orientation right

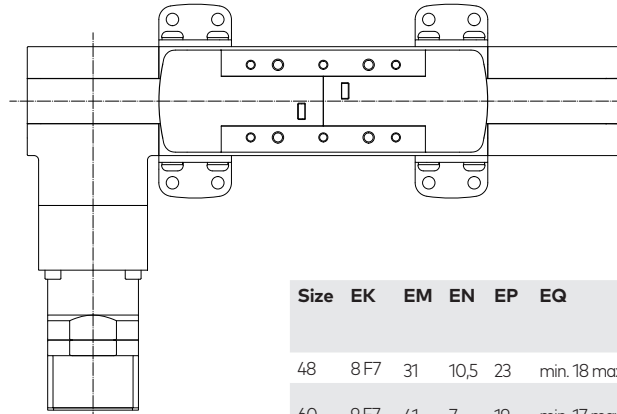
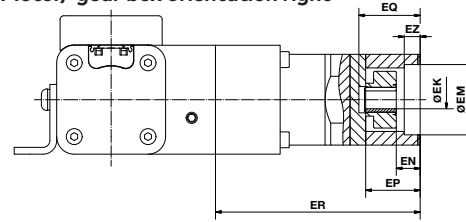
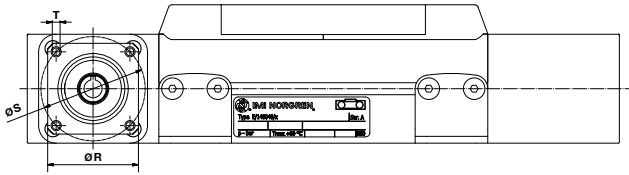

Size	EK	EM	EN	EP	EQ	ER	EZ	R	S	T	Weight without motor at 0 mm (kg)	Weight per 100 mm (kg)	Model
48	8 F7	31	10,5	23	min. 18 max. 25	90	6	40	45	M4/9 deep	4,4	0,3	E/148048/*0*/DX1 E/148060/*0*/DX1 E/148060/*0*/DE*
60	9 F7	41	7	19	min. 17 max. 25	115,5	5	60	63	M5/11 deep	6,9	0,4	E/148080/*0*/DX1 E/148080/*0*/DJ* E/148080/*0*/DN*
80	12 F7	61	5,8	21	min. 24,5 max. 35	130,5	6	80	75	M5/11 deep	11,45	0,7	E/148100/*0*/DX1 E/148100/*0*/DN*
100	14 F7	61	5,8	21	min. 24,5 max. 35	129,5	6	80	75	M5/11 deep	20,5	1,1	

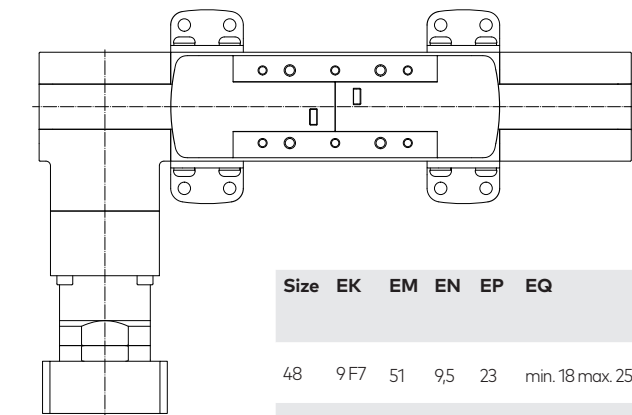
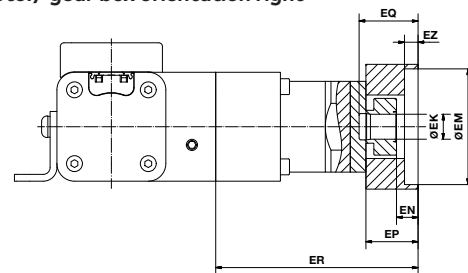
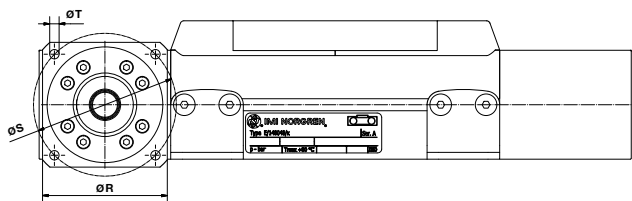

Shown variant E/148000/A*
Motor/ gear box orientation right





Size	Model	Gear ratio
60, 80, 100	E/148***/*03/***	1.3
48	E/148048/*04/***	1.4
60, 80, 100	E/148***/*05/***	1.5
48, 60, 80, 100	E/148***/*07/***	1.7

Size	EK	EM	EN	EP	EQ	ER	EZ	R	S	T	Weight without motor at 0 mm (kg)	Weight per 100 mm (kg)	Model
48	9 F7	51	9,5	23	min. 18 max. 25	89	6	55	63	M5/11 deep	6,05	0,3	E/148048/*0*/DX2 E/148048/*0*/DE*
60	14 F7	61	11	24	min. 22 max. 30	119,5	10	70	75	M5/11 deep	9,3	0,4	E/148060/*0*/DX2 E/148060/*0*/DJ*
100	19 F7	82	20,8	36	min. 34,5 max. 45	143,5	16	90	100	M6/13 deep	25,2	1,1	E/148100/*0*/DX2 E/148100/*0*/DR*

Mountings

	Mountings V	Groove key
		
□	Page 17	Page 17
48	QE/148048/18	M/P74065
60	QE/148060/18	M/P74066
80	QE/148080/18	M/P41858
100	QE/148100/18	M/P76219

Magnetically operated switches

	M/50/**	Switch mounting bracket
		
∅	Page 20	
48		-
60		M/P76273
80		M/P76274
100		M/P76275

	QE/M*
	
□	Page 15 ... 18
55 (1,05 Nm)	QE/M05530/**
67 (2,45 Nm)	QE/M06730/**
67 (3,50 Nm)	QE/M06730/**
89 (6,90 Nm)	QE/M08930/**

Mountings Centre support V

Dimensions in mm
Projection/First angle

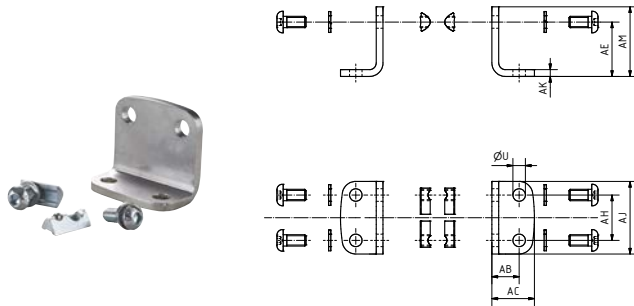

Size	AB	AC	AE	AH	AK	AJ	AM	U	Model
48	12	18.7	24	20	3	32	30.7	5.5	QE/148048/18
60	15	24	30	28	4	44	39	6.6	QE/148060/18
80	17.5	28.7	40	36	4	56	51.2	9	QE/148080/18
100	20	33.2	50	42	5	66	63.2	11	QE/148100/18

Groove key for guide profile

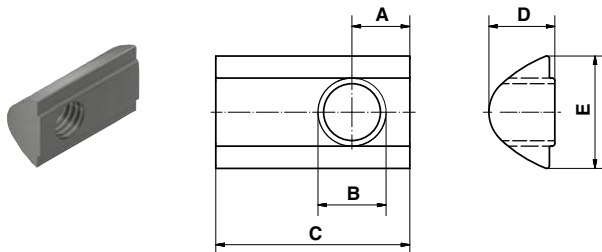

Size	A	B	C	D	E	Weight (kg)	Model
48	4	M5	12	4,25	8	0,01	M/P74065
60	4,5	M6	17	6,25	10,5	0,02	M/P74066
80	7,5	M8	23	7,3	13,5	0,03	M/P41858
100	8,5	M10	28,5	9,7	16,5	0,04	M/P76219

- > Compact servo motor with high dynamics
- > Patented rotor technology
- > Holding brake available
- > Very high torque is required during rapid acceleration and deceleration profiles
- > IP65
- > Rated torques from 1.05 Nm up to 6.90 Nm
- > Optimised for pulse-duty application (300% overload)
- > 400 V three-phase
- > Two different feedback systems (Resolver or absolute (Multi turn))



Technical features

Voltage:

400 VAC

Rated current:

0,7 ... 9 A

Power:

0,16 ... 2,2 kW

Rated speed (rpm):

3000

Ambient temperature:

0 ... 40 °C (32 ... 104 °F)

Humidity:

0 ... 95%

IP Protection rate:

IP65

Plug in for motor cable

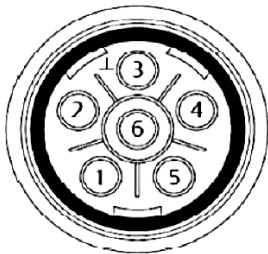

Plug in for feedback cable

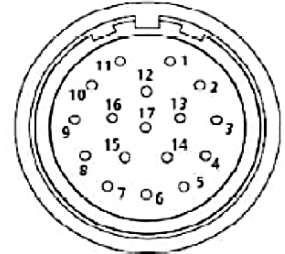
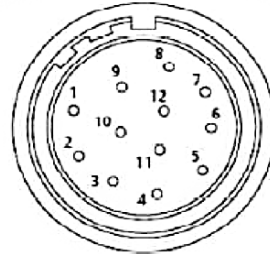

Pin	Function with holding brake	Function without holding brake
1	Phase U (R)	Phase U (R)
2	Phase V (S)	Phase V (S)
3	Ground	Ground
4	Phase W (T)	Phase W (T)
5	Brake +24 V	
6	Brake 0 V	
Shell	Screen	Screen

Pin	Function Resolver	Function Absolute (Multi turn)
1	Excitation High	Thermistor
2	Excitation Low	Thermistor
3	Cos High	Screen (Optical only)
4	Cos Low	
5	Sin High	
6	Sin Low	
7	Thermistor	
8	Thermistor	+ Clock
9		- Clock
10		
11		+ Data
12		- Data
13		- Cos
14		
15		
16		
17		0 Volts
Body	Screen	Screen

For further information please visit:

<http://acim.nidec.com/drives/control-techniques/downloads/user-guides-and-software/unimotorhd>

Motor QE/M05530/*

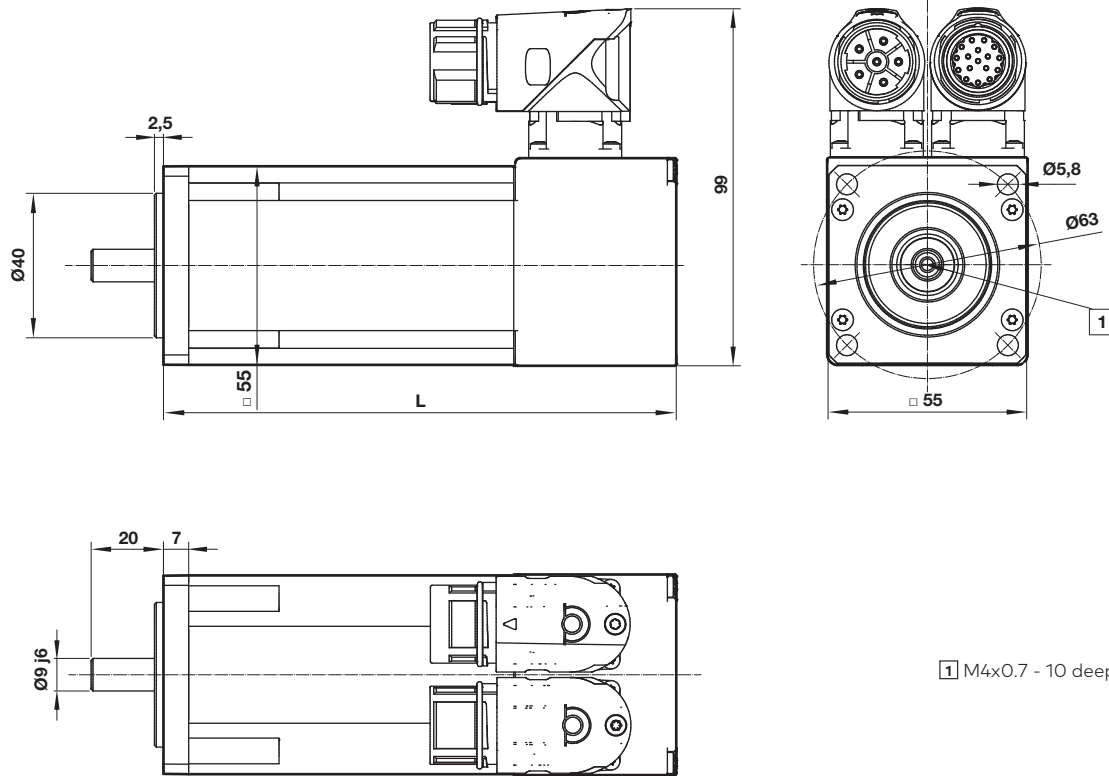
 Dimensions in mm
 Projection/First angle

1 M4x0.7 - 10 deep

Motor-code	Feedback system	Rated torque (Nm)	Rated power (kW)	Stall current (A)	Motor stall torque (Nm)	Motor peak torque (Nm)	Braking torque holding brake (Nm)	Inertia (kg m ²)	Brake	L (mm)	Weight (kg)	Nidec reference number	Model
EA	Resolver	1,05	0,33	0,79	1,18	4,72	-	0,000025	-	142	1,5	055UDB300BAARA063090	QE/M05530/EA/09
EB	Absolute (Multi turn)	1,05	0,33	0,79	1,18	4,72	-	0,000025	-	142	1,5	055UDB300BAEGA063090	QE/M05530/EB/09
EM	Resolver	1,05	0,33	0,79	1,18	4,72	1,8	0,000025	x	182	1,9	055UDB305BAARA063090	QE/M05530/EM/09
EN	Absolute (Multi turn)	1,05	0,33	0,79	1,18	4,72	1,8	0,000025	x	182	1,9	055UDB305BAEGA063090	QE/M05530/EN/09

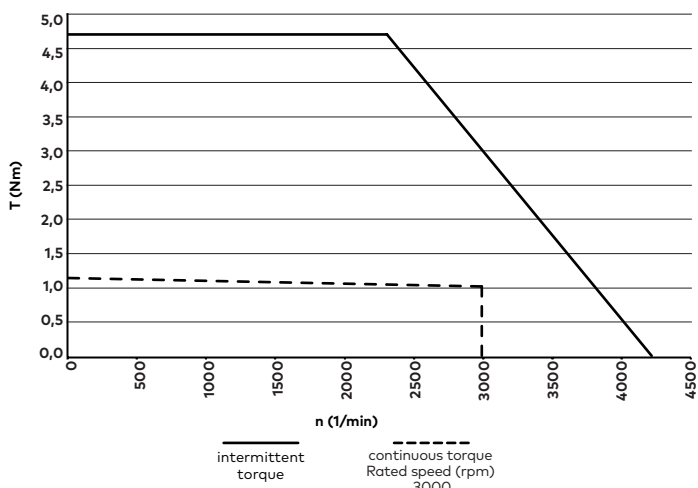
QE/M05530/E*

Motor QE/M06730/*

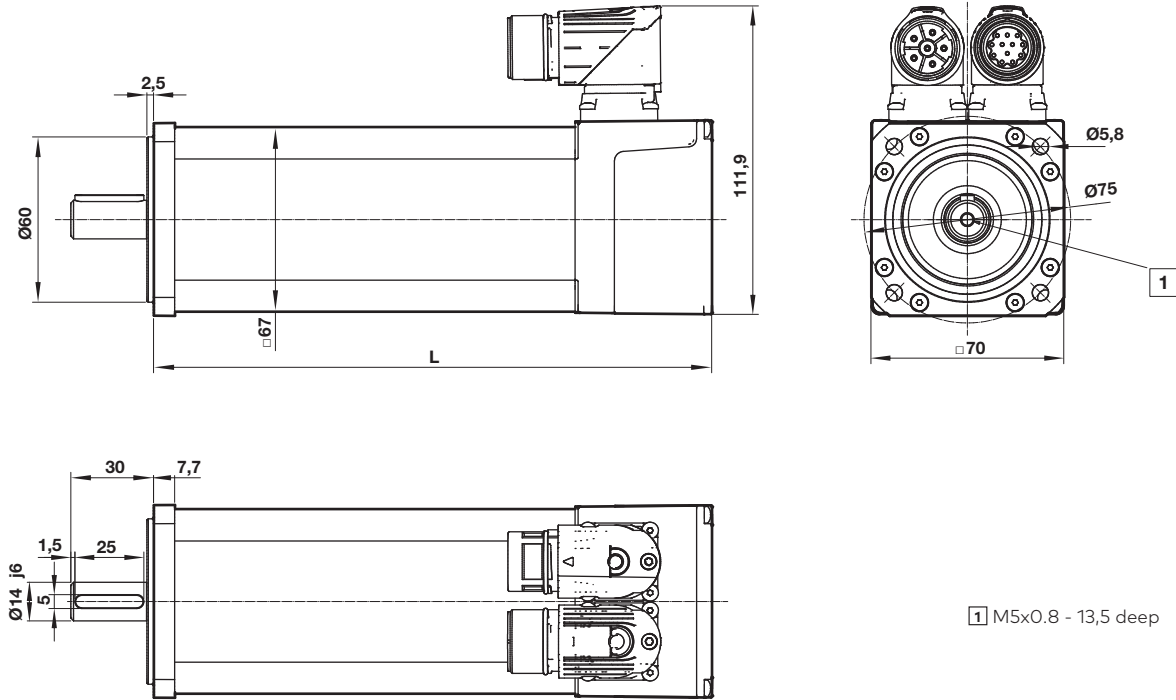
 Dimensions in mm
 Projection/First angle

1 M5x0.8 - 13,5 deep

Motor-code	Feedback system	Rated torque (Nm)	Rated power (kW)	Stall current (A)	Motor stall torque (Nm)	Motor peak torque (Nm)	Braking torque holding brake (Nm)	Inertia (kg m ²)	Brake	L (mm)	Weight (kg)	Nidec reference number	Model
JA	Resolver	2,45	0,77	1,59	2,55	7,65	-	0,000053	-	172,7	2,6	067UDB300BAARA	QE/M06730/JA/14
JB	Absolute (Multi turn)	2,45	0,77	1,59	2,55	7,65	-	0,000053	-	172,7	2,6	067UDB300BAEGA	QE/M06730/JB/14
JM	Resolver	2,45	0,77	1,59	2,55	7,65	2,0	0,000053	x	207,7	3,3	067UDB306BAARA	QE/M06730/JM/14
JN	Absolute (Multi turn)	2,45	0,77	1,59	2,55	7,65	2,0	0,000053	x	207,7	3,3	067UDB306BAEGA	QE/M06730/JN/14
NA	Resolver	3,50	1,10	2,31	3,70	11,10	-	0,000075	-	202,7	3,2	067UDC300BAARA	QE/M06730/NA/14
NB	Absolute (Multi turn)	3,50	1,10	2,31	3,70	11,10	-	0,000075	-	202,7	3,2	067UDC300BAEGA	QE/M06730/NB/14
NM	Resolver	3,50	1,10	2,31	3,70	11,10	2,0	0,000075	x	237,7	3,8	067UDC306BAARA	QE/M06730/NM/14
NN	Absolute (Multi turn)	3,50	1,10	2,31	3,70	11,10	2,0	0,000075	x	237,7	3,8	067UDC306BAEGA	QE/M06730/NN/14

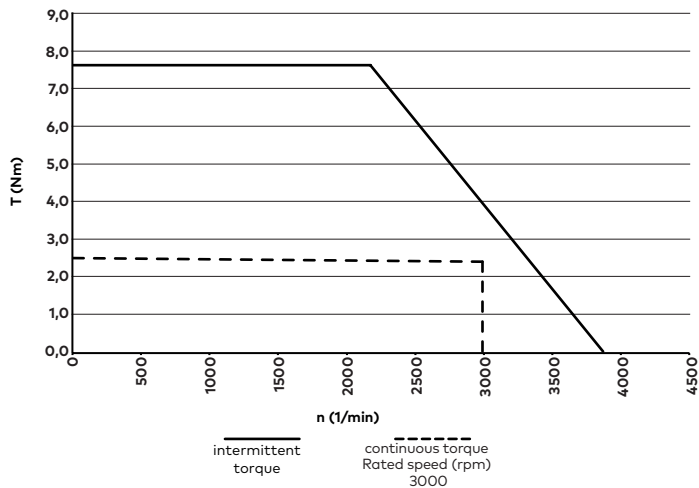
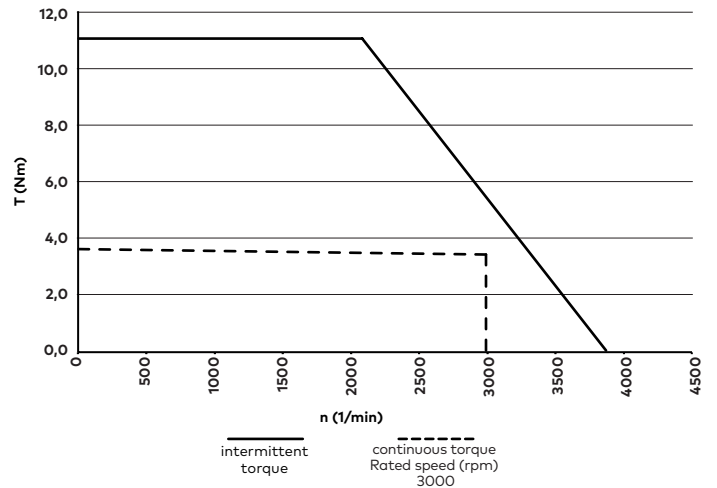
QE/M06730/J*

QE/M06730/N*

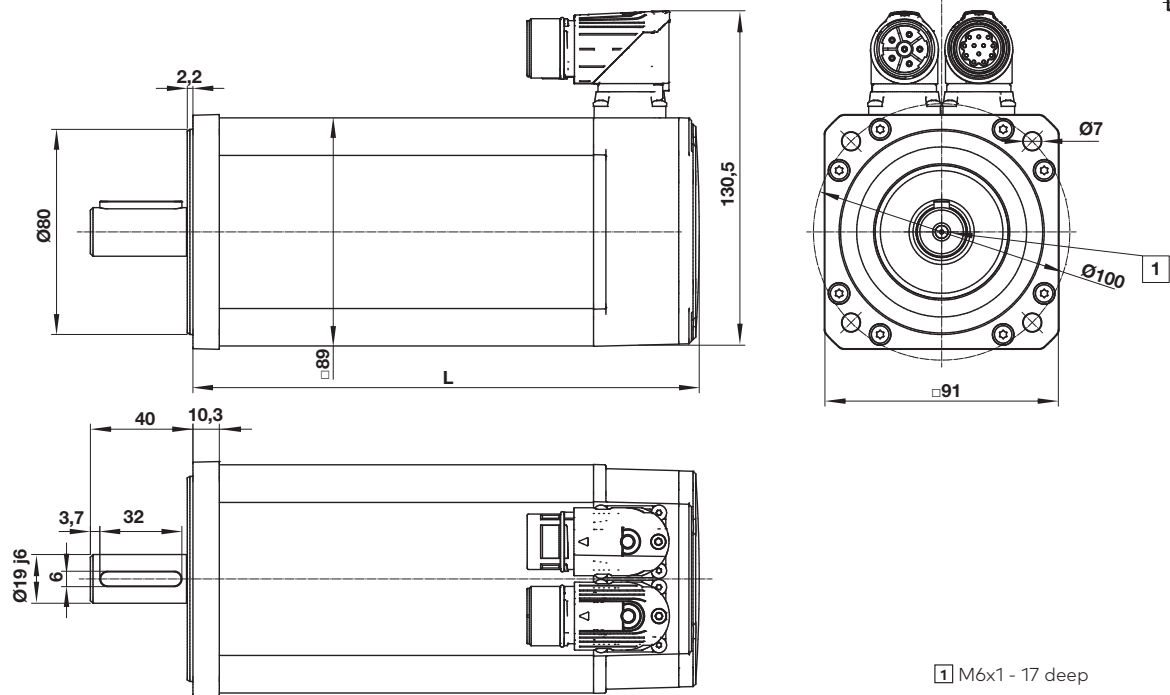
Motor QE/M08930/*

 Dimensions in mm
 Projection/First angle

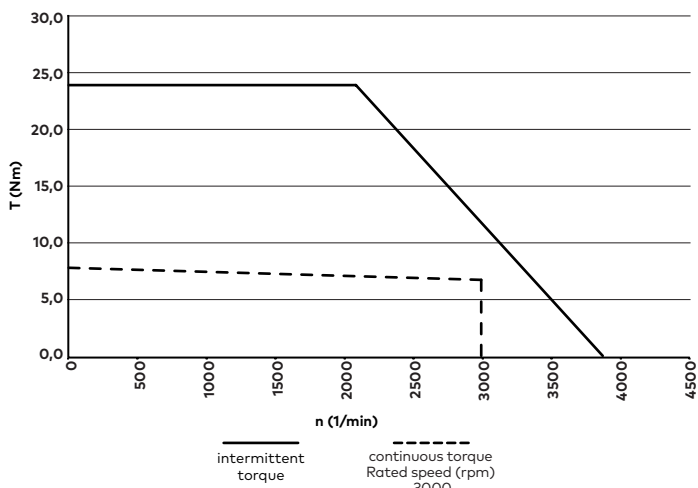
Motor-code	Feedback system	Rated torque (Nm)	Rated power (kW)	Stall current (A)	Motor stall torque (Nm)	Motor peak torque (Nm)	Braking torque holding brake (Nm)	Inertia (kg m ²)	Brake	L (mm)	Weight (kg)	Nidec reference number	Model
RA	Resolver	6,90	2,17	5,0	8,0	24,0	-	0,000234	-	197,8	5,5	089UDC300BAAEA	QE/M08930/RA/19
RB	Absolute (Multi turn)	6,90	2,17	5,0	8,0	24,0	-	0,000234	-	207,8	4,9	089UDC300BAECA	QE/M08930/RB/19
RM	Resolver	6,90	2,17	5,0	8,0	24,0	10,0	0,000234	x	237,9	6,8	089UDC306BAAEA	QE/M08930/RM/19
RN	Absolute (Multi turn)	6,90	2,17	5,0	8,0	24,0	10,0	0,000234	x	247,9	6,2	089UDC306BAECA	QE/M08930/RN/19

QE/M08930/R*

- > 2 Compact drive frame sizes with maximum performance
- > Onboard Advanced Motion Controller for distributed 1.5 axis motion control
- > Integrated Dual Safe Torque Off - "SIL3 and PLe"
- > Option module flexibility
- > Drives available with EtherCAT, PROFINET, PROFIBUS, EtherNet/IP, DeviceNet & CANopen communications
- > Built-in RS485 communications
- > SD Card slot

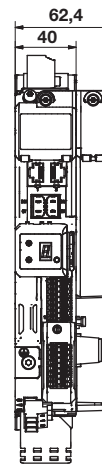
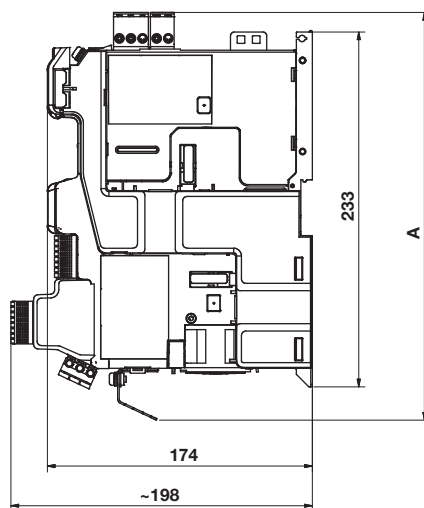
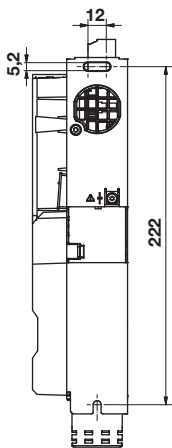

A	B	C	Nidec reference number	Standard model drive
~ 268	233	222	M751-01400030A10100AB110	QE/D01400030
~ 313	278	267	M751-02400105A10100AB110	QE/D02400105

Description	Line supply (VAC)	Voltage (V)	Output power (kW):	max. Power (kW)	Rated current (A)	max. Peak current (A)	max. output frequency (Hz)	Overload closed loop	Overload open loop	Nidec reference number	Standard model drive
Standard drive with internal Bus-system (for motor size □55 - 67)	three-phase 380 ... 480 (±10%) at 45 ... 66 Hz	400	0,75	6,5	3	9	599	300% for 0,25 s or 200% for 4 s	150% for 8 s	M751-01400030A10100AB110	QE/D01400030
Standard drive with internal Bus-system (for motor size □89 - 115)	three-phase 380 ... 480 (±10%) at 45 ... 66 Hz	400	4,0	8,7	10,5	31,5	599	300% for 0,25 s or 200% for 4 s	150% for 8 s	M751-02400105A10100AB110	QE/D02400105

For further information please visit:

<http://acim.nidec.com/drives/control-techniques/downloads/user-guides-and-software/digitax-hd>

- > Magnetically operated reed switch - Round style
- > Suitable for all cylinder ranges with magnetic piston
- > Switches can be mounted flush with the delivered special adaptor
- > LED indicator on LSU models
- > Alternative variants allow a wide range of application



Technical features

Operation:

M/50/LSU Normally open with LED (yellow)

Switching voltage (Ub):

10 ... 240 VAC/170 VDC

Switching voltage output:

Ub - 2,7 V

Switching current

(see graph overleaf):

0,18 A max.

Switching power:

10 W/10 VA max.

Contact resistance:

150 mΩ

Response time:

1,8 ms

Operating temperature:

-25 ... +80 °C (-13 ... +176 °F)

High temperature version:

+150 °C max.(+302 °F)

Protection rating (EN 60529):

IP66

Shock resistance:

50 g (during 11 ms)

Vibration resistance:

35 g (at 2000 Hz)

Cable type:

2 x 0,25: PVC, PUR or silicone

3 x 0,25 PVC

Cable length:

2, 5 or 10 m

Electromagnetic compatibility

according to:

EN 60947-5-2

Materials:

Body: plastic

Cable: see table below

Technical data - Reed switches - additional information see data sheet en 4.3.005

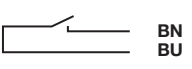
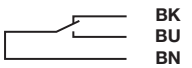
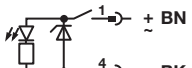
Symbol	Voltage		Current maximum (mA)	Function	Operating temperature (°C)	LED	Protection class	Plug	Cable length (m)	Cable type	Weight (g)	Model
	(VAC)	(VDC)										
	10 ... 240	10 ... 170	180	Normally open	-25 ... +80	•	IP 66	—	2, 5 or 10	PVC 2 x 0,25	37	M/50/LSU/*V
	10 ... 240	10 ... 170	180	Normally open	-25 ... +80	•	IP 66	—	5	PUR 2 x 0,25	37	M/50/LSU/SU
	10 ... 240	10 ... 170	180	Normally open	-25 ... +150	—	IP 66	—	2	Silicon 2 x 0,25	37	TM/50/RAU/2S
	10 ... 240	10 ... 170	180	Changeover	-25 ... +80	—	IP 66	—	5	PVC 3 x 0,25	37	M/50/RAC/5V
	10 ... 60	10 ... 60	180	Normally open	-25 ... +80	•	IP 66	M8 x1	0,3	PVC 3 x 0,25	16	M/50/LSU/CP *1)
	10 ... 60	10 ... 60	180	Normally open	-25 ... +80	•	IP 66	M12 x1	0,3	PVC 3 x 0,25	16	M/50/LSU/CC *1)

* Insert cable length; *1) Plug-in connector see page 22

M/50/LSU/*V, M/50/LSU/5U,
TM/50/RAU/2S
Cable length L = 2, 5 or 10 m

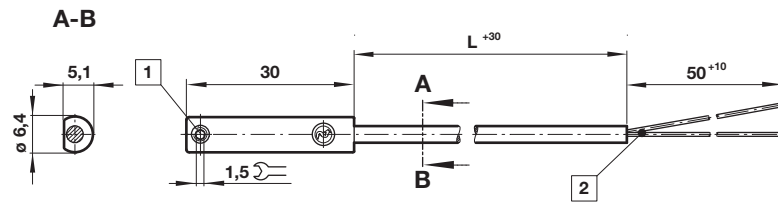

Dimensions in mm
Projection/First angle



M/50/RAC/5V
Cable length L = 5 m

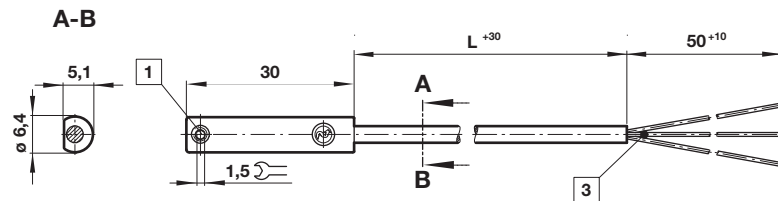

M/50/LSU/CP
M/50/LSU/CC

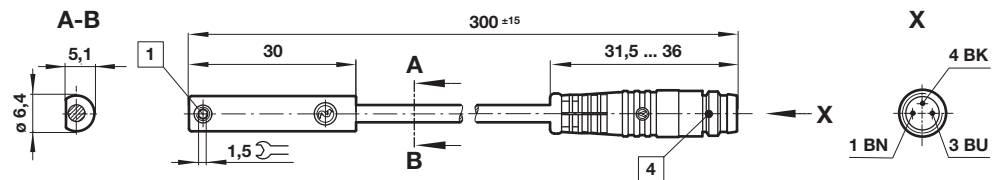

- 1 Fixing screw
- 2 + BN = brown; - BU = blue (output)
- 3 - BK = black; + BN = brown; - BU = blue
- 4 Version CP: Plug M8 x 1, color code: BK = +; BN = -; BU = output
Version CC: Plug M12 x 1, color code: BK = +; BN = -; BU = output

Accessories

Plug-in connector cable with nut



Outer cover	Cable length (m)	Weight (kg)	Connector	Connector
PVC 3 x 0,25	5	0,18	M8 x 1	M/P73001/5
PUR 3 x 0,25	5	0,18	M8 x 1	M/P73002/5
PUR 3 x 0,34	5	0,21	M12 x 1	M/P34594/5

- > Magnetically operated solid state switch - round style
- > IO-Link version available
- > Suitable for all cylinder ranges with magnetic piston
- > Switches can be mounted flush in all profile cylinders
- > Reliable switching with a very fast reponse time
- > Particularly suited for use in high levels of vibration
- > LED indicator as standard
- > CE certified
- > UL listed





Technical features

Operation:

M/50/EAP (PNP) open collector output with LED (yellow)

M/50/EAN (NPN) grounded emitter output with LED (yellow)

M/50/IOP (PNP) Easy IO-Link open collector output with LED (yellow)

Switching voltage (Ub):

10 ... 30 VDC

Switching voltage output:

Ub - 2 V

Inducted voltage:

0,5 V

Switching current (see graph overleaf):

100 mA max.

Switching power:

3,0 W max.

Response time:

< 0,5 ms for EAP switch

< = 1 ms for IOP switch

Operating frequency:

1 kHz

Protection rating (EN 60529):

IP67 (standard)

IP68 for type: M/50/EAP/5U

Operating temperature:

-40 ... +80 °C (-40 ... 176 °F)
(IP67 & IP68)

Cable type:

PVC 3 x 0,12 (standard)

PUR 3 x 0,14 (M/50/EAP/5U)

Cable length:

2, 5 and 10 m

Electromagnetic compatibility according to:

EN 60947-5-2

Materials:

Body: plastic

Cable: see table below

Technical data - Solid state

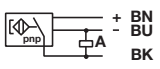
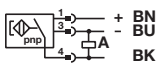
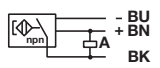
Symbol	Voltage (VDC)	Current maximum (mA)	Function	IO-Link *2)	Operating temperature (°C)	LED	Protection class	Plug	Cable length (m)	Cable type	Weight (g)	Model
	10 ... 30	100	PNP		-40 ... +80	•	IP67	—	2,5 or 10	PVC 3x0,12	37	M/50/EAP/*V
	10 ... 30	100	PNP	•	-40 ... +80	•	IP67	—	5	PVC 3x0,12	37	M/50/IOP/5V
	10 ... 30	100	PNP		-40 ... +80	•	IP68	—	5	PUR 3x0,14	37	M/50/EAP/5U
	10 ... 30	100	PNP		-40 ... +80	•	IP67	M8x1	0,3	PVC 3x0,14	16	M/50/EAP/CP *1)
	10 ... 30	100	PNP	•	-40 ... +80	•	IP67	M8x1	0,3	PVC 3x0,14	16	M/50/IOP/CP *1)
	10 ... 30	100	PNP		-40 ... +80	•	IP67	M12x1	0,3	PVC 3x0,14	16	M/50/EAP/CC *1)
	10 ... 30	100	NPN		-40 ... +80	•	IP67	—	2,5 or 10	PVC 3x0,12	37	M/50/EAN/*V
	10 ... 30	100	NPN		-40 ... +80	•	IP67	M8x1	0,3	PVC 3x0,14	16	M/50/EAN/CP *1)

* Insert cable length; *1) Plug-in connector below; Color code: BK = black, BN = brown, BU = blue

IO-Link function *2)

- Visual installation aid
- Counter
- Temperature diagnostic
- Power LED

Switching current and switching voltage

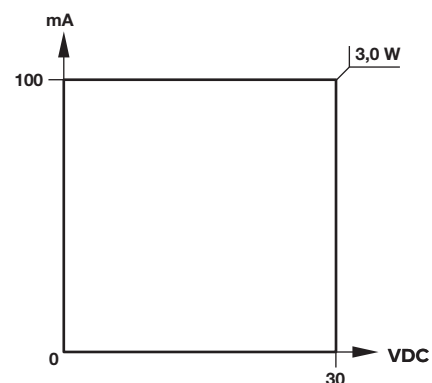

Dimensions

M/50/EAP/*V,
M/50/EAN/*V
M/50/IOP/5V
Cable length L = 2, 5 or 10 m

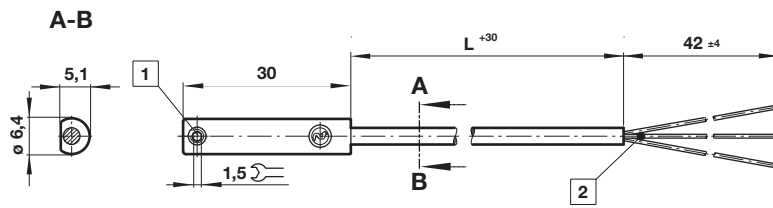

Dimensions in mm
Projection/First angle



M/50/EAP/CP,
M/50/EAN/CP
M/50/IOP/CP

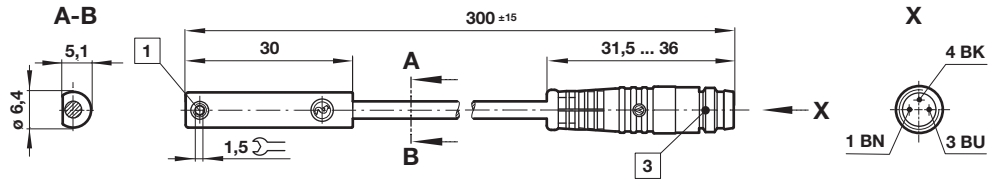

M/50/EAP/CC

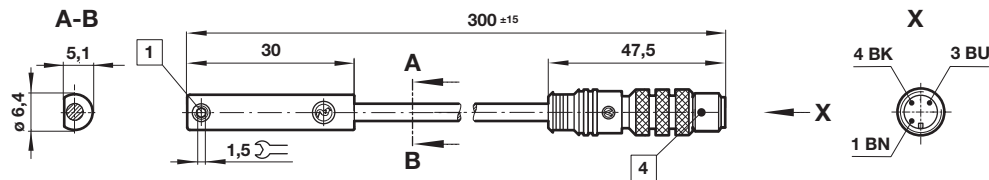

- 1 Fixing screw
- 2 Color code: BK = black; BN = brown; BU = blue
- 3 Plug M8 x 1
- 4 Plug M12 x 1

Accessories

Plug-in connector cable with nut









Outer cover	Cable length (m)	Weight (kg)	Connector	Connector
PVC 3 x 0,25	5	0,18	M8 x 1	M/P73001/5*1)
PUR 3 x 0,25	5	0,18	M8 x 1	M/P73002/5*1)
PVC 3 x 0,25	5	0,18	M8 x 1	M/P34615/5*2)
PUR 3 x 0,25	5	0,18	M8 x 1	M/P34596/5*2)
PUR 3 x 0,34	5	0,21	M12 x 1	M/P34594/5*1)

*1) Straight connector

*2) 90 ° Connector

Bus card



Description	SI-PROFINET RT V2	SI-PROFIBUS	SI-EtherNet/IP	SI-EtherCAT	SI-CANopen	SI-DeviceNet
						
Color code	Green	Purple	Cream	Red	White	Grey
Model	QE/B18200/PN	QE/B17500/PB	QE/B17900/EN	QE/B18000/EC	QE/B17600/CO	QE/B17700/DN

Description SI-I/O
Extended I/O interface module to increase the number of analog and digital In- and Outputs on the drive.





Color code Orange
Model QE/B17800/IO





Power cable

Description	Motor cable without brake	Motor cable with brake
		
Cable length	5 m 10 m	5 m 10 m
Model	QE/C5402/08/5 QE/C5402/08/10	QE/C5402/18/5 QE/C5402/18/10

Feedback cable

Description	Feedback cable resolver	Feedback cable Multi Turn
		
Cable length	5 m 10 m	5 m 10 m
Model	QE/F5400/61/5 QE/F5400/61/10	QE/F5400/30/5 QE/F5400/30/10

Drive accessories

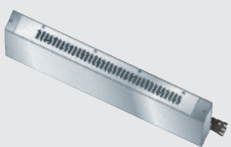
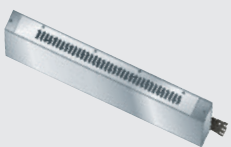
Multiple axis kit short  QE/A9500/1047	long  QE/A9500/1048	USB converter cable  QE/A4500/0096	KI compact display  QE/A20400	EMC filter for	QE/D01400030  QE/A4200/8744	QE/D02400105  QE/A4200/1644
--	---	--	---	-----------------------	---	---

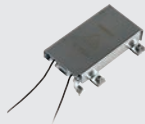
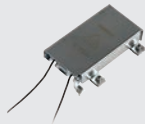
Brake resistor for 50 W  QE/A9500/1049	100 W  QE/A1220/2801
--	--

Warning

These products should only be used where the values listed under **"Technical features/data"** are not exceeded. Please refer to the corresponding catalogue page. Before using the products in non-industrial applications, in life-support or other systems not included in the published instructions, please contact Norgren directly. Misuse, wear, or malfunction can cause components to fail in a variety of ways.

System designers are strongly recommended to consider the failure modes of all component parts used and to take adequate safety precautions to prevent personal injury and damage to equipment in the event of such failure. System designers and end users are cautioned to review specific warnings found in instruction sheets packed and shipped with these products.