

MKDS 5 HV/ 2-9,52-Z

Order No.: 1907432

Printed circuit terminal block, nominal current: 32 A, rated voltage: 690 V, pitch: 9.52 mm, no. of positions: 2, mounting: Soldering, type of connection: Screw connection, connection direction from the conductor to the PCB: 0°

Commercial data

EAN	4017918603946
Pack	50 Pcs.
Customs tariff	85369010
Weight/Piece	0.006842 KG
Catalog page information	Page 285 (CC-2007)

Product notes

WEEE/RoHS-compliant since:
01/01/2003



<http://www.download.phoenixcontact.com>
Please note that the data given here has been taken from the online catalog. For comprehensive information and data, please refer to the user documentation. The General Terms and Conditions of Use apply to Internet downloads.

Certificates / Approvals

Approval logo

**CUL**

Nominal voltage U_N	600 V
Nominal current I_N	30 A
AWG/kcmil	30-10

UL

Nominal voltage U_N	600 V
Nominal current I_N	30 A
AWG/kcmil	30-10
Certification	CUL, UL

Accessories

Item	Designation	Description
------	-------------	-------------

Marking

1051993	B-STIFT	Marker pen, for manual labeling of unprinted Zack strips, smear-proof and waterproof, line thickness 0.5 mm
0803906	SK U/3,8 WH:UNBEDRUCKT	Unprinted marker cards, DIN A4 format, pitch as desired, self-adhesive, with 40 stamped marker strips, 185 mm strip length, can be labeled with the CMS system or manually with the M-PEN

Tools

1205053	SZS 0,6X3,5	Screwdriver, bladed, matches all screw terminal blocks up to 4.0 mm ² connection cross section, blade: 0.6 x 3.5 mm, without VDE approval
---------	-------------	--

Drawings

Drilling diagram

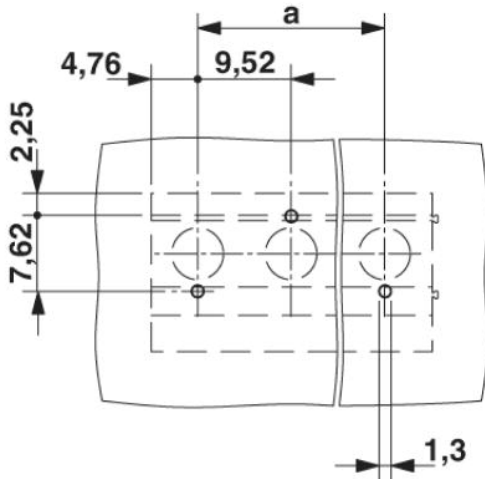

Dimensioned drawing

