

3-PHASE INFEED TERMINAL, FOR 3-PHASE  
BUSBARS, CONNECTION FROM ABOVE, SIZE  
S00/S0

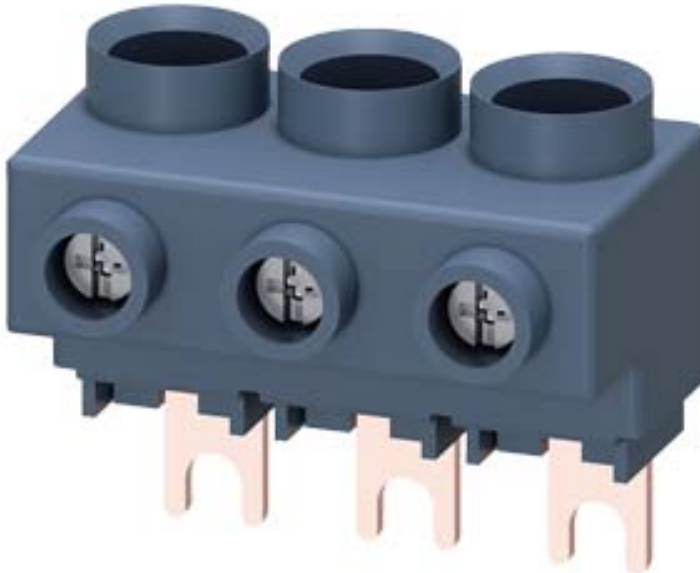

General technical data:

product brand name		SIRIUS
Product designation		Three-phase feeder terminal
Design of the product		from above, size S0/S00
Size of the circuit-breaker		S00, S0
Protection class IP on the front		IP20
Insulation voltage with degree of pollution 3 rated value	V	690
Ambient temperature		
• during storage	°C	-50 ... +80
• during operation	°C	-20 ... +60
Ampacity maximum	A	63

Installation/ mounting/ dimensions:

Width	mm	44.5
Height	mm	39
Depth	mm	27.2

Connections/ Terminals:

Type of electrical connection for main current circuit		screw-type terminals
--	--	----------------------





### Type of connectable conductor cross-sections

- for main contacts
  - solid 1x (2.5 ... 16 mm<sup>2</sup>)
  - stranded 1x (2.5 ... 25 mm<sup>2</sup>)
  - finely stranded
    - with core end processing 1x (2.5 ... 16 mm<sup>2</sup>)
- at AWG conductors for main contacts 1x (10 ... 4)

### Certificates/ approvals:

#### Certificate of suitability

CE / UL / CSA / CCC

General Product Approval		Declaration of Conformity	Test Certificates		Shipping Approval
			<a href="#">Typprüfbescheinigung/Werkszeugnis</a>	<a href="#">spezielle Prüfbescheinigungen</a>	
CSA	UL	EG-Konf.		<u>n</u>	ABS

### Shipping Approval



Shipping Approval	other	Railway			
	<a href="#">Bestätigungen</a>	<a href="#">Umweltbestätigung</a>		<a href="#">Schwingen/Schocke</a>	<a href="#">Bestätigungen</a>
RMRS			VDE	<u>n</u>	

### Further information

#### Information- and Downloadcenter (Catalogs, Brochures,...)

<http://www.siemens.com/industrial-controls/catalogs>

#### Industry Mall (Online ordering system)

<http://www.siemens.com/industrymall>

#### Cax online generator

<http://support.automation.siemens.com/WW/CAXorder/default.aspx?lang=en&mlfb=3RV29255AB>

#### Service&Support (Manuals, Certificates, Characteristics, FAQs,...)

<https://support.industry.siemens.com/cs/ww/en/ps/3RV29255AB>

#### Image database (product images, 2D dimension drawings, 3D models, device circuit diagrams, EPLAN macros, ...)

[http://www.automation.siemens.com/bilddb/cax\\_de.aspx?mlfb=3RV29255AB&lang=en](http://www.automation.siemens.com/bilddb/cax_de.aspx?mlfb=3RV29255AB&lang=en)

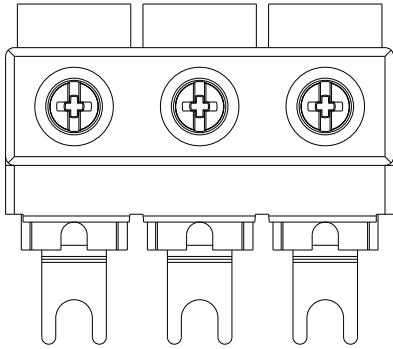

last modified:

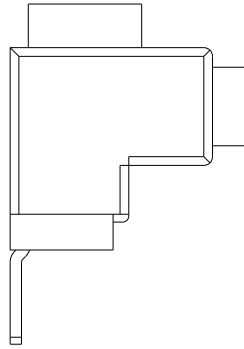

07.12.2015