















# SMD/BLOCK Type EMI Suppression Filters EMIFIL<sup>®</sup>



## Introduction

Murata Manufacturing Co., Ltd. has been developing the EMI suppression device market since the invention of 3 terminal capacitor DS310 series in 1979. Also, we have been striving to develop and popularize new noise countermeasure technologies as well as new products in the concept of "Develop unique products," to become our customer's best solution partner. We hope you can find the key solution to your noise problem.

### Explanation of symbols in this catalog

	Features of each series	Features of each item
All Products	 <b>Flow</b> Flow soldering available	 <b>New</b> New product
	 <b>Reflow</b> Reflow soldering available	 <b>Kit</b> Exist in design kit
	 <b>Hi Power</b> Meets large current lines	 <b>≥1A</b> Rated current 1A or more
Chip Ferrite Bead	 <b>GHz</b> Meets high frequency noise up to 1-2GHz	 <b>≥3A</b> Rated current 3A or more
	 <b>Hi-GHz</b> Meets ultra high frequency noise up to 10GHz	 <b>≥10A</b> Rated current 10A or more
LC Combined Type Filter		 <b>DTV</b> Low cut-off frequency type for UHF band noise, which affects digital TV tuner
Chip Common Mode Choke Coil		 <b>HD</b> For high speed differential signal lines (USB2.0/LVDS/IEEE1394 etc.)
		 <b>UD</b> For ultra high speed differential signal lines (HDMI/DVI/Display Port/USB3.0 etc.)
		 <b>Imp Match</b> Line impedance has been matched to transmission lines

### EU RoHS Compliant

- All the products in this catalog comply with EU RoHS.
- EU RoHS is "the European Directive 2011/65/EU on the Restriction of the Use of Certain Hazardous Substances in Electrical and Electronic Equipment."
- For more details, please refer to our website 'Murata's Approach for EU RoHS' (<http://www.murata.com/info/rohs.html>).

⚠Note • Please read rating and ⚠CAUTION (for storage, operating, rating, soldering, mounting and handling) in this catalog to prevent smoking and/or burning, etc.  
 • This catalog has only typical specifications. Therefore, please approve our product specifications or transact the approval sheet for product specifications before ordering.

# CONTENTS

Selection Guide for Noise Suppression Filters .....	2
EMI Filter Selection by Application .....	4
• Digital Still Camera .....	4
• Blu-ray/DVD .....	6
• Smartphone .....	5
• LCD-TV .....	7
EMI Filter Selection by Circuits and Noise Frequency .....	8
Product Guide .....	10

## BL<sup>□</sup> Chip Ferrite Bead

Series Introduction .....	14
Part Numbering .....	16
Series Line Up .....	18
Product Detail .....	24
⚠ Caution/Notice .....	99
Soldering and Mounting .....	100
Packaging .....	104
Design Kits .....	105

## NF<sup>□</sup> Chip EMIFIL<sup>®</sup>

Series Introduction .....	112
Part Numbering .....	114
Series Line Up .....	117
Product Detail .....	121
⚠ Caution/Notice .....	154
Soldering and Mounting .....	156
Packaging .....	163
Design Kits .....	165

## DL<sup>□</sup>/PL<sup>□</sup> Chip Common Mode Choke Coil

Series Introduction .....	170
Part Numbering .....	172
Series Line Up .....	174
Product Detail .....	177
⚠ Caution/Notice .....	203
Soldering and Mounting .....	205
Packaging .....	212
Design Kits .....	214

## BNX Block Type EMIFIL<sup>®</sup>

Series Line Up .....	218
Function Example .....	218
Product Detail .....	221
⚠ Caution/Notice .....	225
Soldering and Mounting .....	227
Packaging .....	231
Design Kits .....	232

## EA Microwave Absorber



Part Numbering .....	234
Product Detail .....	235
Notice .....	238

Product Guide by Size .....	239
Part Number Quick Reference .....	240
Alphabetic Product Name Index .....	240
Introduction of Related Catalogs .....	241
Introduction of EMI/MLCC/Inductor special web site "EMICON-FUN!" .....	242

⚠ Note • Please read rating and ⚠ CAUTION (for storage, operating, rating, soldering, mounting and handling) in this catalog to prevent smoking and/or burning, etc.  
• This catalog has only typical specifications. Therefore, please approve our product specifications or transact the approval sheet for product specifications before ordering.

# Selection Guide for Noise Suppression Filters

## ● Features & Suitable Circuits

Type	Features	Suitable Circuits
<b>Ferrite Bead</b> BLM/BLA Series 	<ul style="list-style-type: none"> <li>• Miniaturized</li> <li>• GND connection unnecessary</li> <li>• Effective at low impedance line</li> </ul>	<ul style="list-style-type: none"> <li>• Application set with less noise radiation</li> <li>• Low impedance line</li> </ul>
<b>Capacitor Type</b> NFM/NFA/NFE/NFR/ NFL/NFW Series 	<ul style="list-style-type: none"> <li>• Great noise suppression effect</li> <li>• With effect as By-Pass capacitor (Lineup for Power)</li> <li>• Good noise separation from signal (LC filter for Signal)</li> <li>• Effective at high impedance line</li> </ul>	<ul style="list-style-type: none"> <li>• Application set with higher noise radiation</li> <li>• High impedance line</li> <li>• Circuit with By-Pass capacitor</li> <li>• Circuit driven by high frequency</li> </ul>
<b>Common Mode Choke Coil</b> 	<ul style="list-style-type: none"> <li>• Possible to suppress noise with less affect of ultra high speed signal</li> <li>• Great effect for common mode noise</li> <li>• Less magnetic saturation by current</li> </ul>	<ul style="list-style-type: none"> <li>• High speed differential signal line</li> <li>• I/F cable driver</li> <li>• Power line</li> </ul>

## ● Example

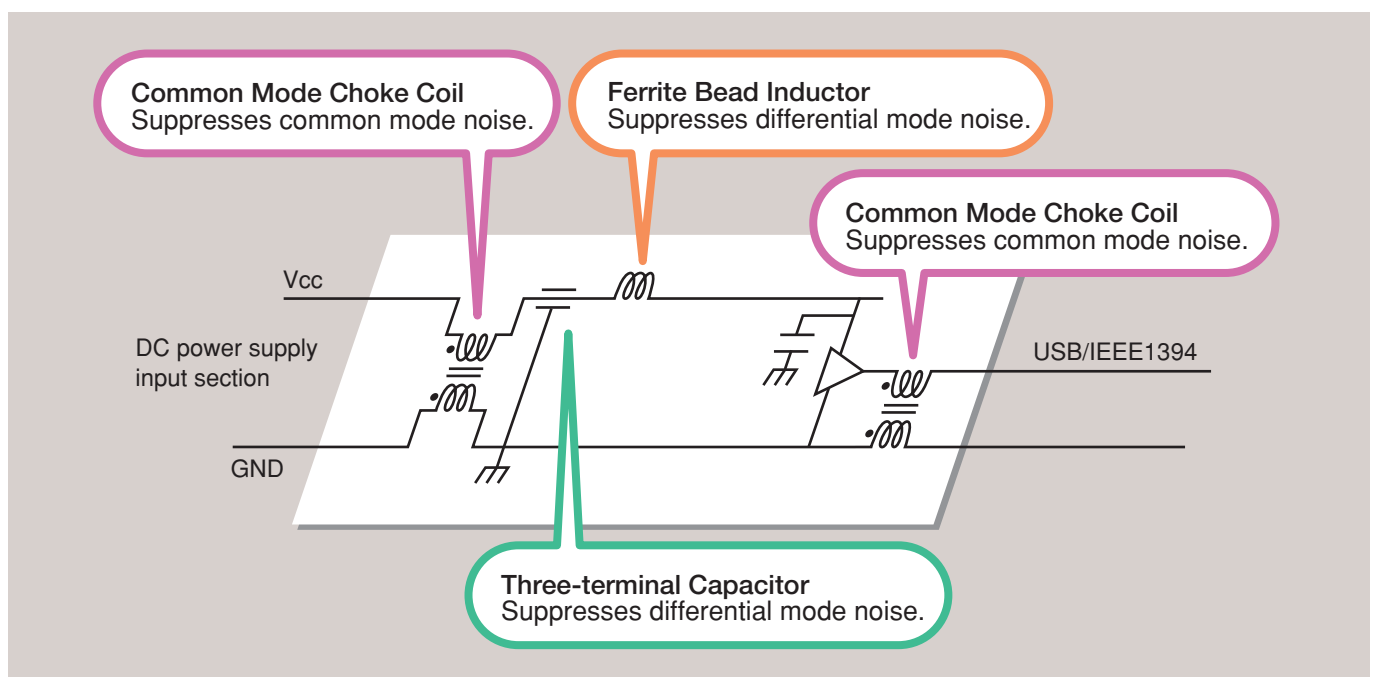

△Note • Please read rating and △CAUTION (for storage, operating, rating, soldering, mounting and handling) in this catalog to prevent smoking and/or burning, etc.  
 • This catalog has only typical specifications. Therefore, please approve our product specifications or transact the approval sheet for product specifications before ordering.

## ● Advantages to Using Common Mode Choke Coils

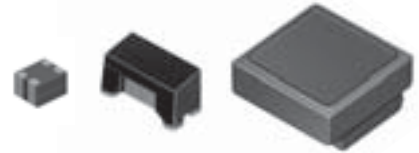

### 1. Great Effect for Common Mode Noise

Differential mode inductors work as a half impedance for common mode noise. Common Mode Choke Coils are effective for common mode noise.

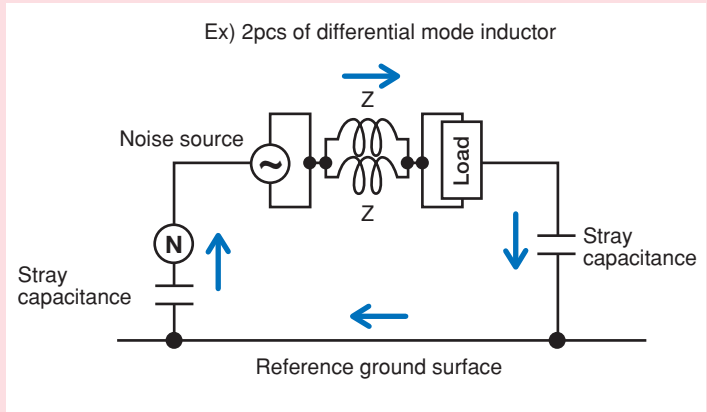

### 2. Possible to Suppress Noise with Less Affect of Ultra High Speed Signal

Common Mode Choke Coils can suppress Noise with less affect of Signal, even if the frequency range of Signal and Noise are the same, because they separate each conductive mode of current.

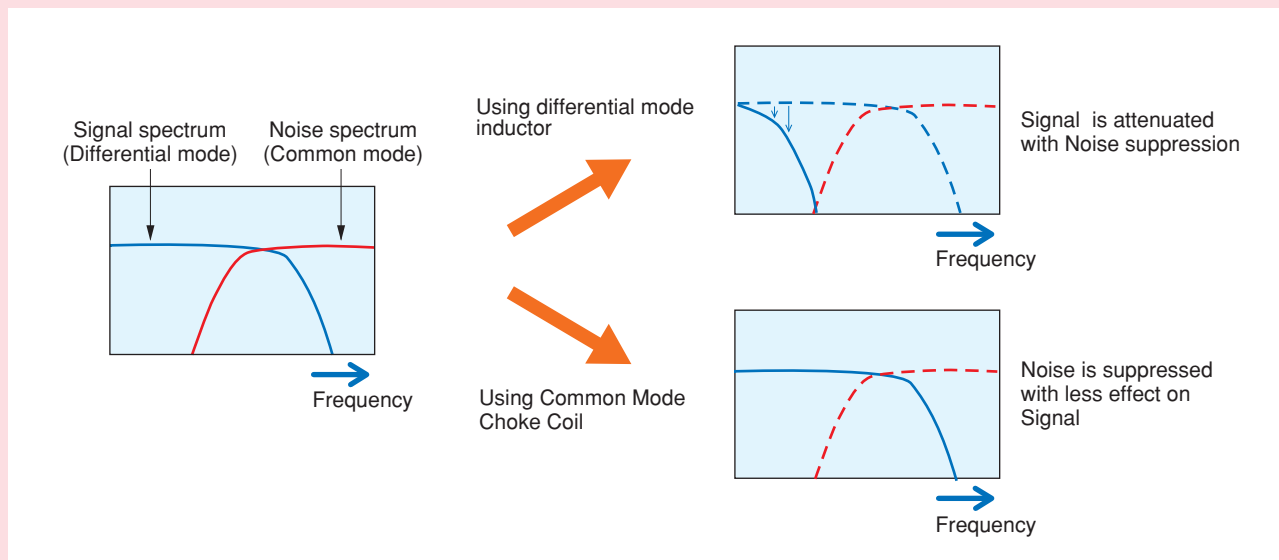

### 3. Less Magnetic Saturation by Current

Common Mode Choke Coils are effective for noise suppression of DC power lines, due to their less magnetic saturation at high power current, that comes from their construction of cancelling magnetic flux of differential mode current at each coil.

△Note • Please read rating and △CAUTION (for storage, operating, rating, soldering, mounting and handling) in this catalog to prevent smoking and/or burning, etc.  
• This catalog has only typical specifications. Therefore, please approve our product specifications or transact the approval sheet for product specifications before ordering.

## Digital Still Camera

Application Sample

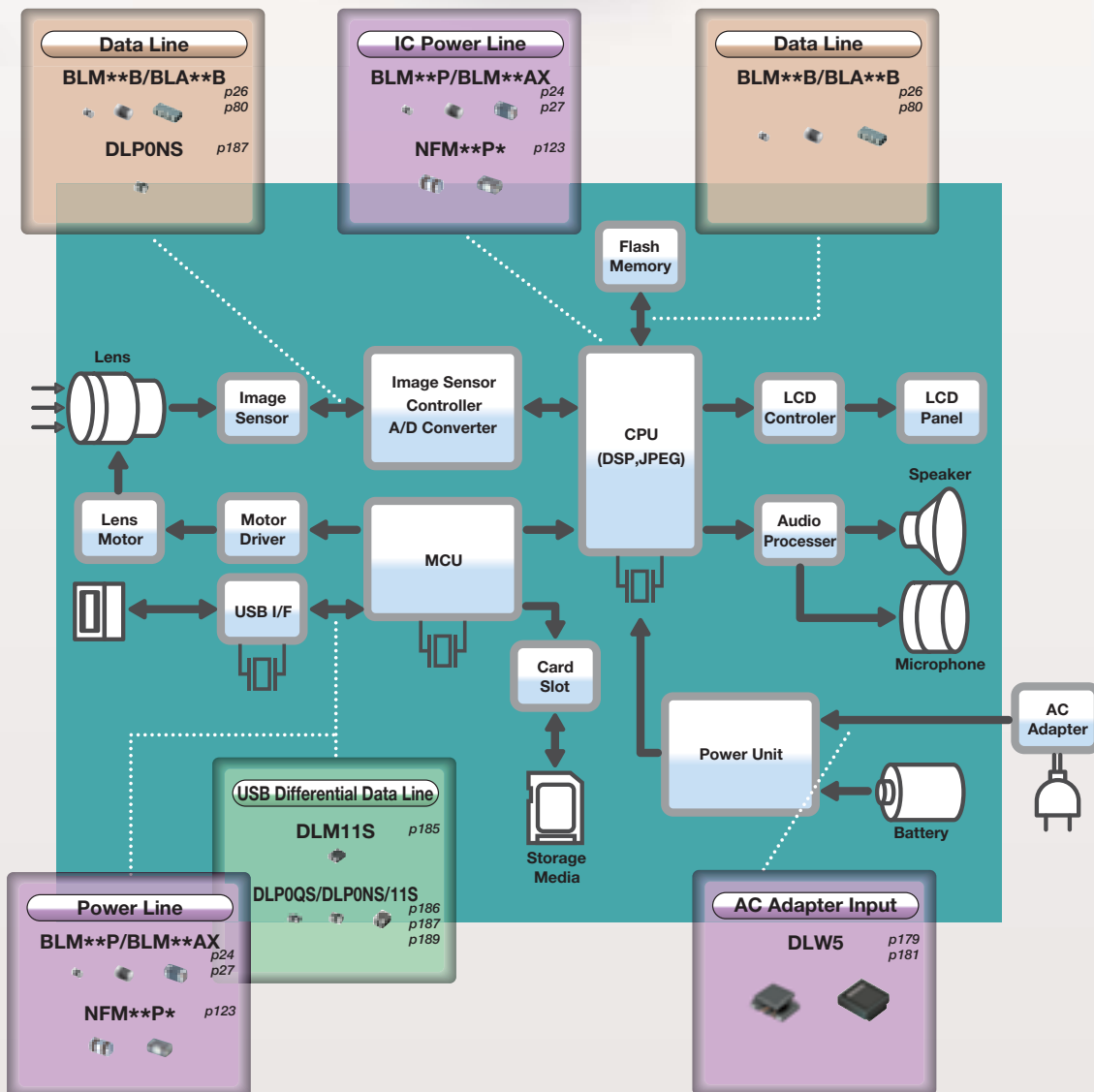
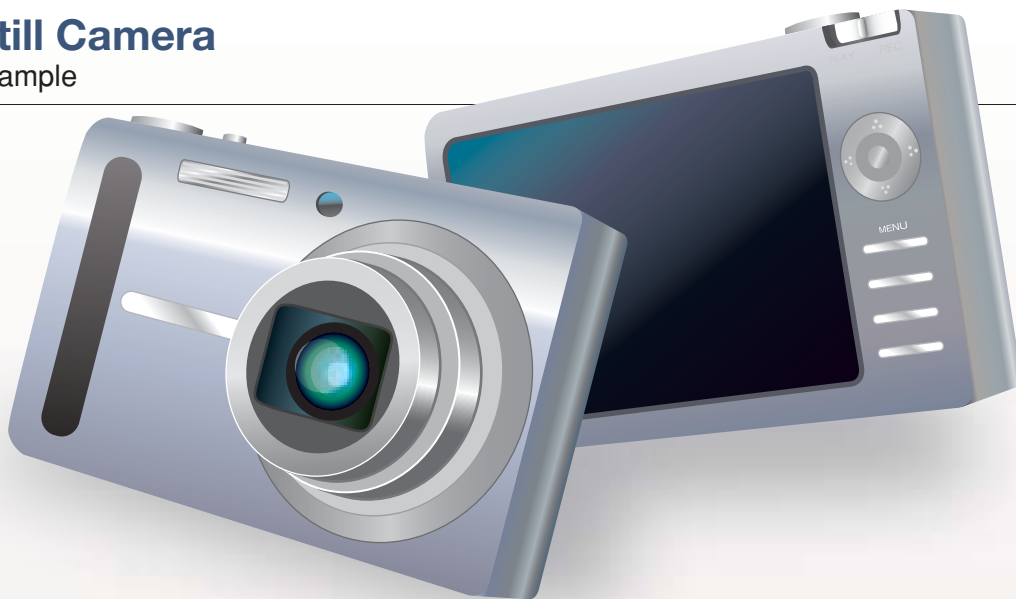

△Note • Please read rating and △CAUTION (for storage, operating, rating, soldering, mounting and handling) in this catalog to prevent smoking and/or burning, etc.  
 • This catalog has only typical specifications. Therefore, please approve our product specifications or transact the approval sheet for product specifications before ordering.

# Smartphone

Application Sample

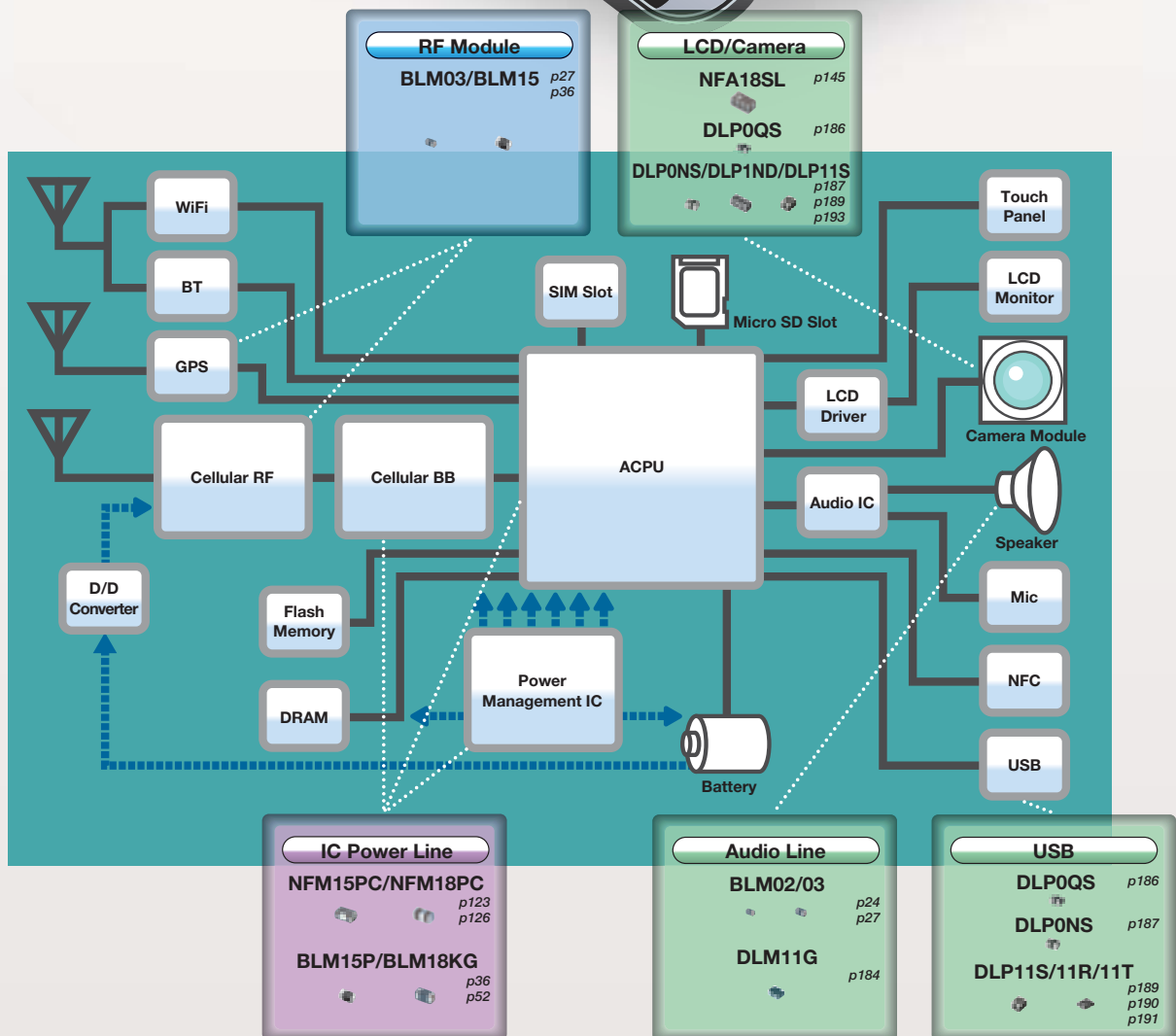

△Note • Please read rating and △CAUTION (for storage, operating, rating, soldering, mounting and handling) in this catalog to prevent smoking and/or burning, etc.  
• This catalog has only typical specifications. Therefore, please approve our product specifications or transact the approval sheet for product specifications before ordering.

# Blu-ray/DVD

Application Sample

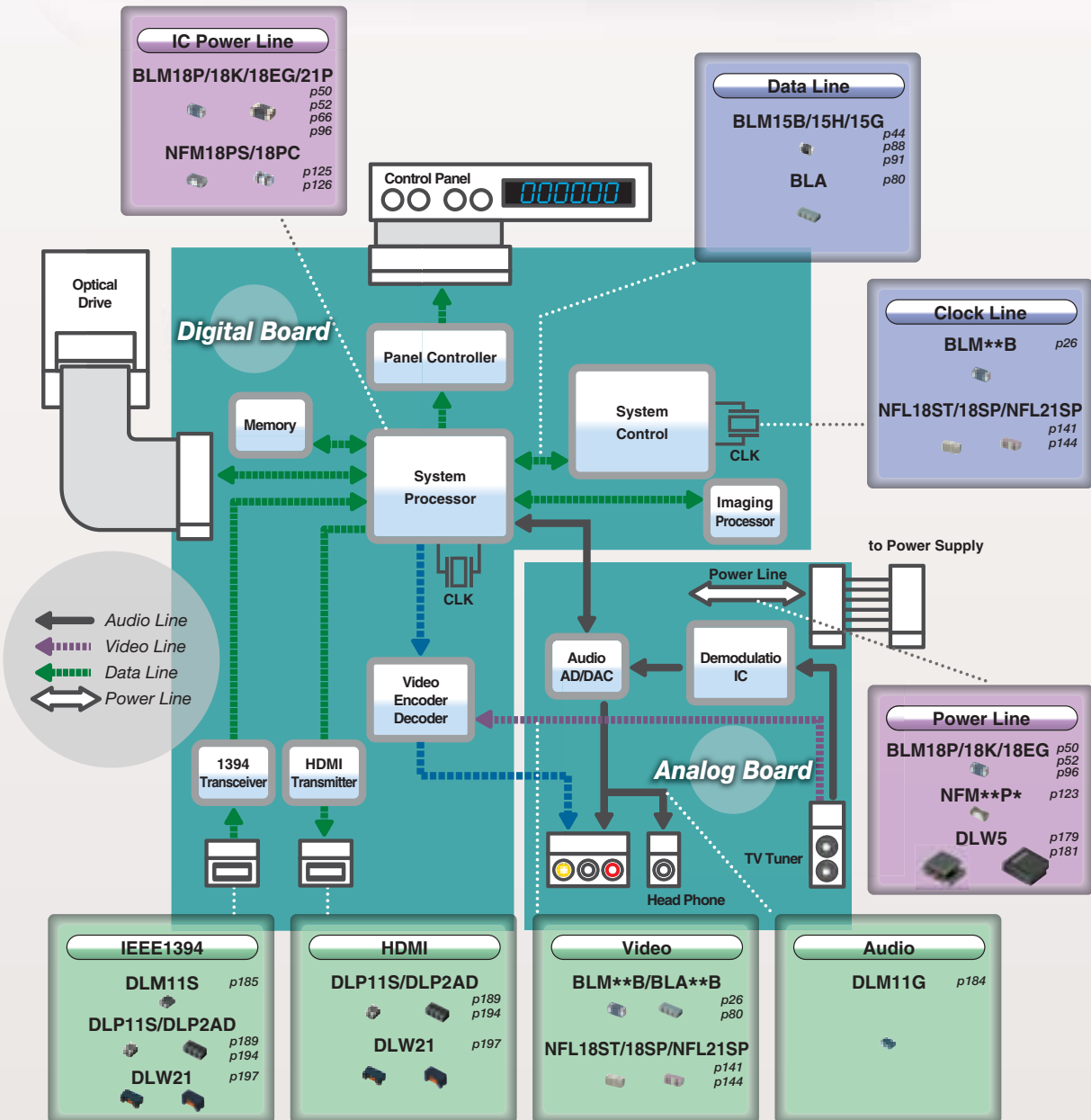

△Note • Please read rating and △CAUTION (for storage, operating, rating, soldering, mounting and handling) in this catalog to prevent smoking and/or burning, etc.  
 • This catalog has only typical specifications. Therefore, please approve our product specifications or transact the approval sheet for product specifications before ordering.



# LCD-TV

Application Sample

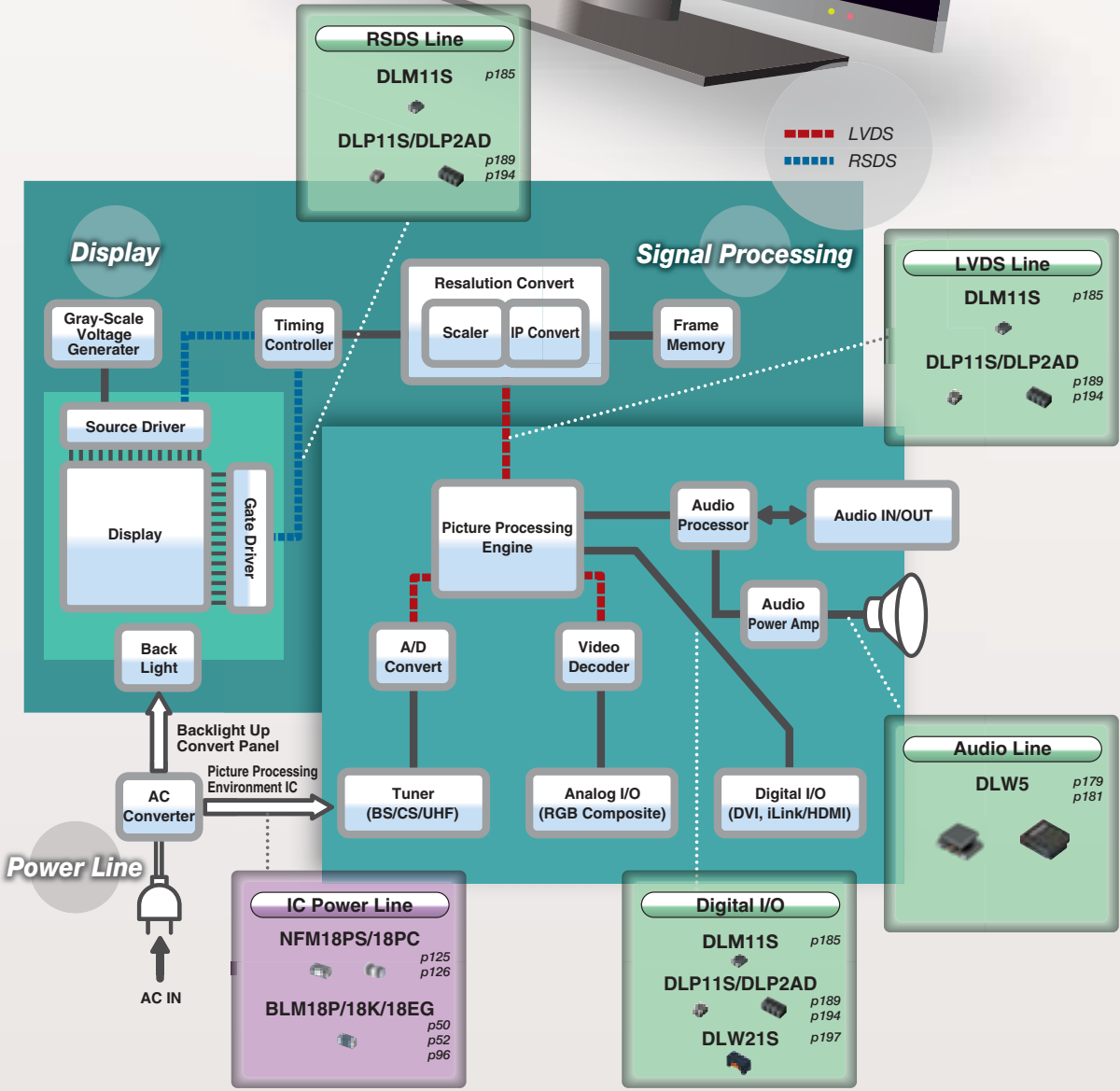

△Note • Please read rating and △CAUTION (for storage, operating, rating, soldering, mounting and handling) in this catalog to prevent smoking and/or burning, etc.  
 • This catalog has only typical specifications. Therefore, please approve our product specifications or transact the approval sheet for product specifications before ordering.

# EMI Filter Selection by Circuits and Noise Frequency

## ● Chip Ferrite Bead / Chip EMIFIL®

		Circuit Type?		
		Power Line	General Signal Line Under 10MHz	High Speed Signal Line Over 10MHz
Noise Frequency: Under 1GHz	Inductor Type (Suppression Effect: Normal)	BLM02AX 01005(0402)/Imp.10-120Ω	BLM03AX 0201(0603)/0.2-1A/Imp.10-1000Ω	BLM02BX 01005(0402)/Imp.150Ω
		BLM03PG 0201(0603)/0.75-0.9A/Imp.22-33Ω	BLM03AG 0201(0603)/Imp.10-1000Ω	BLM03B 0201(0603)/Imp.10-600Ω
		<b>Low DC Resistance / High Current Type</b>	BLM15AG 0402(1005)/Imp.10-1000Ω	BLM15BX 0402(1005)/0.25-0.6A/Imp.75-1800Ω
		BLM03PX 0201(0603)/1-1.8A/Imp.22-80Ω	BLM18A 0603(1608)/Imp.120-1000Ω	BLM15B 0402(1005)/Imp.5-1800Ω
		BLM15AX 0402(1005)/0.35-1.74A/Imp.10-1000Ω	BLM18R 0603(1608)/Imp.120-1000Ω	BLM18B 0603(1608)/Imp.5-2500Ω
		BLM15PX 0402(1005)/0.9-3A/Imp.33-600Ω	BLM21R 0805(2012)/Imp.120-1000Ω	BLM21B 0805(2012)/Imp.5-2700Ω
		BLM15PG/PD 0402(1005)/1-2.2A/Imp.10-120Ω	<b>Array Type</b>	<b>Array Type</b>
		BLM18P 0603(1608)/0.5-3A/Imp.30-470Ω	BLA2AA 0804(2010)/Imp.120-1000Ω	BLA2AB 0804(2010)/Imp.10-1000Ω
		BLM21P 0805(2012)/1.5-6A/Imp.22-330Ω	BLA31A 1206(3216)/Imp.30-1000Ω	BLA31B 1206(3216)/Imp.120-1000Ω
		BLM31P 1206(3216)/1.5-6A/Imp.33-600Ω		
BLM41P 1806(4516)/1.5-6A/Imp.60-1000Ω				
BLE32P 1210(3225)/10A/Imp.30Ω				
<b>Low DC Resistance Type</b>				
BLM18K 0603(1608)/1.3-6A/Imp.26-600Ω				
BLM18S 0603(1608)/1.5-6A/Imp.26-330Ω				
Noise Frequency: High	Capacitor Type (Suppression Effect: High)	NFM15PC 0402(1005)/Cap.0.047-4.3μF	NFM15CC 0402(1005)/Cap.2200-22000pF	NFL15ST 0402(1005)/Cut off 150-500MHz
		NFM18PC 0603(1608)/2-4A/Cap.0.1-2.2μF	NFM18CC 0603(1608)/Cap.22-22000pF	NFL18ST 0603(1608)/Cut off 50-500MHz
		NFM21PC 0805(2012)/2-6A/Cap.0.1-4.7μF	NFM21CC 0805(2012)/Cap.22-22000pF	NFL18SP 0603(1608)/Cut off 150-500MHz
		NFM3DPC 1205(3212)/2A/Cap.0.022μF	NFM3DCC 1205(3212)/Cap.22-22000pF	NFL21SP 0805(2012)/Cut off 10-500MHz
		NFM31PC 1206(3216)/6A/Cap.27μF	NFM41CC 1806(4516)/Cap.22-22000pF	NFW31SP 1206(3216)/Cut off 10-500MHz
		NFM31KC 1206(3216)/6-10A/Cap.0.01-0.1μF	<b>Array Type</b>	<b>RC Combined</b>
		NFM41PC 1806(4516)/2-6A/Cap.0.2-1.5μF	NFA31CC 1206(3216)/Cap.22-22000pF	NFR21GD 0805(2012)/22-100Ω/Cap.10-100pF
		<b>T Circuit Filter Feed Through Type</b>	<b>T Circuit Filter Feed Through Type</b>	<b>Array Type (RC/LC Combined)</b>
		NFE31PT 1206(3216)/6A/Cap.22-2200pF	NFE31PT 1206(3216)/Cap.22-2200pF	NFA31GD 1206(3216)/6.8-100Ω/Cap.10-100pF
		NFE61PT 2706(6816)/2A/Cap.33-4700pF	NFE61PT 2706(6816)/Cap.33-4700pF	NFA18SL/NFA18SD 0603(1608)/Cut off 50-480MHz
<b>Block Type</b>		NFA21SL 0805(2012)/Cut off 50-330MHz		
BNX022/023 10-15A				
Noise Frequency: GHz Band (800MHz to 2.5GHz)	Inductor Type (Suppression Effect: Normal)		BLM03HG 0201(0603)/Imp.600-1200Ω	BLM03HD 0201(0603)/Imp.330-1000Ω
			BLM15HG 0402(1005)/Imp.600-1000Ω	BLM03HB 0201(0603)/Imp.190Ω
			BLM18HG 0603(1608)/Imp.470-1000Ω	BLM15HD 0402(1005)/Imp.600-1800Ω
			BLM18HK 0603(1608)/Imp.330-1000Ω	BLM15HB 0402(1005)/Imp.120-220Ω
		BLM18HE 0603(1608)/0.5-0.8A/Imp.600-1500Ω		BLM18HD 0603(1608)/Imp.470-1000Ω
		BLM03E 0201(0603)/0.4-0.6A/Imp.25-50Ω		BLM18HE 0603(1608)/Imp.600-1500Ω
		BLM15E 0402(1005)/0.7-1.5A/Imp.120-220Ω		BLM18HB 0603(1608)/Imp.120-330Ω
		BLM18E 0603(1608)/0.5-2A/Imp.100-600Ω		
Noise Frequency: High-Chz Band (1GHz to 10GHz)	Capacitor Type (Suppression Effect: High)	NFM18PS 0603(1608)/2A/Cap.0.47-1.0μF		NFL18ST 0603(1608)/Cut off 50-500MHz
		NFM21PS 0805(2012)/4A/Cap.10μF		<b>Array Type (LC Combined)</b>
Noise Frequency: High-Chz Band (1GHz to 10GHz)	Inductor Type		BLM15GG 0402(1005)/Imp.220-470Ω	BLM15GA 0402(1005)/Imp.75Ω
			BLM18G 0603(1608)/Imp.470Ω	

△Note • Please read rating and △CAUTION (for storage, operating, rating, soldering, mounting and handling) in this catalog to prevent smoking and/or burning, etc.  
• This catalog has only typical specifications. Therefore, please approve our product specifications or transact the approval sheet for product specifications before ordering.

●Chip Common Mode Choke Coil

Circuit Type?

DC Power Line	High Speed Differential Signal Line		Audio Line
	High Speed Signal Line (USB/LVDS/IEEE1394/mipi etc.)	Ultra High Speed Signal Line (HDMI/DVI/Display Port etc.)	
<b>DLW5AH</b> <small>p177</small> 2014(5036)/0.2A/Imp.4000Ω	<b>DLM11S</b> <small>p185</small> 0504(1210)/Imp.45-90Ω	<b>DLP0QSA</b> <small>p186</small> 025020(0605)/Imp.7-35Ω	<b>DLM11G</b> <small>p184</small> 0504(1210)/Imp.600Ω
<b>DLW5AT</b> <small>p179</small> 2014(5036)/1-6A/Imp.50-2700Ω	<b>DLP0QSN</b> <small>p186</small> 025020(0605)/Imp.60Ω	<b>DLP0NSA</b> <small>p187</small> 03025(0806)/Imp.7-15Ω	<b>DLW5AT</b> <small>p179</small> 2014(5036)/1-6A/Imp.50-2700Ω
<b>DLW5BS</b> <small>p177</small> 2020(5050)/0.5-5A/Imp.190-3000Ω	<b>DLP0NSC/SN</b> <small>p187</small> 03025(0806)/Imp.28-120Ω	<b>DLP11SA</b> <small>p189</small> 0504(1210)/Imp.35-90Ω	<b>DLW5BT</b> <small>p179</small> 2020(5050)/1.5-6A/Imp.100-1400Ω
<b>DLW5BT</b> <small>p179</small> 2020(5050)/1.5-6A/Imp.100-1400Ω	<b>DLP11SN</b> <small>p189</small> 0504(1210)/Imp.67-330Ω	<b>DLP11RB</b> <small>p189</small> 0504(1210)/Imp.15-40Ω	
<b>High Current Type Automotive Available</b>	<b>DLP11RN</b> <small>p189</small> 0504(1210)/Imp.45Ω	<b>DLP11TB</b> <small>p189</small> 0504(1210)/Imp.80Ω	
<b>PLT10HH</b> <small>p202</small> 12.9mmx6.6mm /6-18A/Imp.45-1000Ω	<b>DLW21H</b> <small>p199</small> 0805(2012)/Imp.67-180Ω	<b>Array Type</b>	
	<b>DLW21S_S/X</b> <small>p197</small> 0805(2012)/Imp.67-500Ω	<b>DLW21S_HQ</b> <small>p197</small> 0805(2012)/Imp.67-120Ω	
	<b>DLP31S</b> <small>p192</small> 1206(3216)/Imp.120-550Ω	<b>DLP2ADA</b> <small>p194</small> 0804(2010)/Imp.35-90Ω	
	<b>DLW31S</b> <small>p200</small> 1206(3216)/Imp.90-2200Ω		
	<b>Automotive Available</b>		
	<b>DLW43S</b> <small>p201</small> 1812(4532)		
	<b>Array Type</b>		
	<b>DLP1ND</b> <small>p193</small> 05025(1506)/Imp.35-90Ω		
	<b>DLP2ADN</b> <small>p194</small> 0804(2010)/Imp.67-280Ω		
	<b>DLP31D</b> <small>p196</small> 1206(3216)/Imp.90-440Ω		

Guide of Digits in this Chart:

●for BLM03P

0201(0603)/0.75-0.9A/Imp.22-33Ω  
 Size (inch)    Size (mm)    Rated Current    Impedance

●for NFA18S

0603(1608)/Cut off 50-480MHz  
 Size (inch)    Size (mm)    Cut-off Frequency

●for BNX022/023

10-15A/Range1MHz-2GHz  
 Rated Current    Effective Frequency Range

●for DLW5BS

2020(5050)/0.5-5A/Imp.190-3000Ω  
 Size (inch)    Size (mm)    Rated Current    Impedance

●for NFR21GD

0805(2012)/22-100Ω/Cap.10-100pF  
 Size (inch)    Size (mm)    Resistance    Capacitance

△Note • Please read rating and △CAUTION (for storage, operating, rating, soldering, mounting and handling) in this catalog to prevent smoking and/or burning, etc.  
 • This catalog has only typical specifications. Therefore, please approve our product specifications or transact the approval sheet for product specifications before ordering.



Inductor Type		Series	Size Code in inch (in mm)	Impedance ( $\Omega$ ) at 100MHz			Effective Frequency Range (Applicable Frequency Ranges are only for reference.)														
				10	100	1000	10kHz	100kHz	1MHz	10MHz	100MHz	1GHz	10GHz								
For General Band Noise	Universal Type [ Power Lines / Signal Lines ]	BLM02AX <sup>p24</sup>	01005 (0402)	10	70	120															
		BLM03AX <sup>p30</sup>	0201 (0603)	10	80	120	240	600	1000												
		BLM15AX <sup>p40</sup>	0402 (1005)	10	30	70	120	220	600	1000											
	Signal Lines Type	For General Signal Lines	BLM03AG <sup>p32</sup>	0201 (0603)	10	80	120	240	600	1000											
			BLM15AG <sup>p42</sup>	0402 (1005)	10	70	120	220	600	1000											
			BLM18A <sup>p56</sup>	0603 (1608)				220	470	600	1000										
			BLM21A <sup>p68</sup>	0805 (2012)				220	470	600	1000										
			BLM18T <sup>p62</sup>	0603 (1608)				120	220	600	1000										
		BLA2AA (4 circuits array) <sup>p80</sup>	0804 (2010)				120	220	600	1000											
		BLA31A (4 circuits array) <sup>p83</sup>	1206 (3216)	30	60	120	220	600	1000												
		For High Speed Signal Lines	BLM02BX <sup>p26</sup>	01005 (0402)				150													
			BLM03B <sup>p34</sup>	0201 (0603)	10	22	33	56	80	600											
			BLM15B <sup>p44</sup>	0402 (1005)	5	10	22	33	75	120	220	470	1000								
	BLM18B <sup>p58</sup>		0603 (1608)	5	10	22	47	60	75	140	220	420	600	1500	2200						
	BLM21B <sup>p70</sup>		0805 (2012)	5			75	200	330	470	750	1500	2200	2700							
	For Digital Interface Lines	BLA2AB (4 circuits array) <sup>p80</sup>	0804 (2010)	10	22	47	75	120	220	470	1000										
		BLA31B (4 circuits array) <sup>p83</sup>	1206 (3216)							600	470	1000									
		BLM18R <sup>p63</sup>	0603 (1608)							120	220	470	1000								
	BLM21R <sup>p73</sup>	0805 (2012)							120	220	470	1000									
	Power Lines Type	BLM03PX* <sup>p28</sup>	0201 (0603)				33 (1.5A)	80 (1A)													
BLM03PG <sup>p27</sup>		0201 (0603)				33 (0.75A)															
BLM15P* <sup>p36</sup>		0402 (1005)	10 (1A)	30 (2.2A)	60 (1.7A/2.5A)	120 (1.3A/2A)	330 (1.2A)	600 (0.9A)													
BLM18P* <sup>p50</sup>		0603 (1608)				33 (3A)	120 (2A)	220 (1.4A)	470 (1A)												
BLM21P* <sup>p66</sup>		0805 (2012)				30 (4A)	220 (2A)														
BLM31P* <sup>p75</sup>		1206 (3216)				50 (3.5A)	390 (2A)														
BLM41P* <sup>p77</sup>		1806 (4516)				33 (6A)	120 (3.5A)	600 (1.5A)													
BLM18K* (Low DC Resistance Type) <sup>p52</sup>		0603 (1608)				75 (3.5A)	470 (2A)	1000 (1.5A)													
BLM18S* (Low DC Resistance Type) <sup>p54</sup>		0603 (1608)				30 (5A)	70 (3.5A)	220 (2.2A)	470 (1.5A)												
BLE32P <sup>p79</sup>		1210 (3225)				26 (6A)	100 (3A)	120 (3A)	330 (1.7A)	600 (1.3A)											
BLE32P <sup>p79</sup>		1210 (3225)				26 (6A)	70 (4A)	220 (2.5A)													
For GHz Band Noise		Universal Type [ Power Lines / Signal Lines ]	BLM03E* <sup>p87</sup>	0201 (0603)			25 (0.6A)	50 (0.4A)													
	BLM15E* <sup>p90</sup>		0402 (1005)					220 (0.7A)													
	BLM18EG* <sup>p96</sup>		0603 (1608)					120 (2A)	330 (0.5A)	470 (0.5A)	600 (0.5A)										
	BLM18HE* <sup>p92</sup>		0603 (1608)							1000 (0.6A)	600 (0.8A)	1500 (0.5A)									
	Signal Lines Type	BLM03HG <sup>p85</sup>	0201 (0603)						1000	1200											
		BLM03HD <sup>p85</sup>	0201 (0603)						600												
		BLM03HB <sup>p85</sup>	0201 (0603)					190													
		BLM15HG <sup>p88</sup>	0402 (1005)						600	1000											
		BLM15HD <sup>p88</sup>	0402 (1005)						600	1000	1800										
		BLM15HB <sup>p88</sup>	0402 (1005)					120	220												
		BLM18HG <sup>p92</sup>	0603 (1608)						600	470	1000										
		BLM18HD <sup>p92</sup>	0603 (1608)						600	470	1000										
		BLM18HB <sup>p92</sup>	0603 (1608)					120	220	330											
		BLM18HK <sup>p92</sup>	0603 (1608)							330	470	1000									
		For High-GHz Band Noise	Signal Lines Type	BLM15GG <sup>p91</sup>	0402 (1005)					220	470										
BLM15GA <sup>p91</sup>	0402 (1005)						75														
BLM18G <sup>p98</sup>	0603 (1608)									470											

\* The derating of rated current is required for some items according to the operating temperature on each product page.

⚠Note • Please read rating and ⚠CAUTION (for storage, operating, rating, soldering, mounting and handling) in this catalog to prevent smoking and/or burning, etc.  
• This catalog has only typical specifications. Therefore, please approve our product specifications or transact the approval sheet for product specifications before ordering.



Capacitor Type	Series	Size Code in inch (in mm)	Capacitance (F)							Effective Frequency Range (Applicable Frequency Ranges are only for reference.)						
			10p	100p	1000p	10000p	0.1μ	1μ	10μ	10kHz	100kHz	1MHz	10MHz	100MHz	1GHz	10GHz
Signal Lines Type	NFM15CC <sup>p134</sup>	0402 (1005)			2200	22000										
	NFM18CC <sup>p135</sup>	0603 (1608)			470	2200	22000									
	NFM21CC <sup>p136</sup>	0805 (2012)			470	2200	22000									
	NFM3DCC <sup>p137</sup>	1205 (3212)			470	2200	22000									
	NFM41CC <sup>p138</sup>	1806 (4516)			470	2200	22000									
	NFA31CC (4 circuits array) <sup>p139</sup>	1206 (3216)			470	2200	22000									
Power Lines Type	NFM15PC <sup>p123</sup>	0402 (1005)				47000	0.22	1.0								
	NFM18PS <sup>p125</sup>	0603 (1608)				0.1	0.47	4.3								
	NFM18PC <sup>p126</sup>	0603 (1608)					1.0	0.47								
	NFM21PS <sup>p128</sup>	0805 (2012)					0.22	1.0	2.2							
	NFM21PC <sup>p129</sup>	0805 (2012)					0.1	0.47	2.2	10						
	NFM3DPC* <sup>p130</sup>	1205 (3212)				22000										
	NFM31PC <sup>p131</sup>	1206 (3216)								27						
	NFM31KC* <sup>p132</sup>	1206 (3216)				10000	22000	15000	0.1							
	NFM41PC <sup>p133</sup>	1806 (4516)						0.2	1.5							
Universal Type [Power Lines / Signal Lines]	NFE31PT <sup>p121</sup>	1206 (3216)			470	2200										
	NFE61PT <sup>p122</sup>	2706 (6816)			100	360	1000									
			33	68	180	680	4700									



LC(RC) Combined Type	Series	Size Code in inch (in mm)	Cut-off Frequency (MHz)							Effective Frequency Range (Applicable Frequency Ranges are only for reference.)						
			10	100	500	10	100	500	10kHz	100kHz	1MHz	10MHz	100MHz	1GHz	10GHz	
Signal Lines Type	NFL15ST <sup>p140</sup>	0402 (1005)			150	200	300	500								
	NFL18ST <sup>p141</sup>	0603 (1608)			50	70	100	200	300	500						
	NFL18SP <sup>p143</sup>	0603 (1608)					150	200	300	500						
	NFL21SP <sup>p144</sup>	0805 (2012)	10	20			50	70	100	150	200	300	400	500		
	NFA18SL (4 circuits array) <sup>p145</sup>	0603 (1608)					50	130	180	220	300	350	480			
	NFA18SD (4 circuits array) <sup>p147</sup>	0603 (1608)								200						
	NFA21SL (4 circuits array) <sup>p148</sup>	0805 (2012)								200	280	310	300	330		
	NFW31SP <sup>p150</sup>	1206 (3216)	10	20			50	100	150	200	300	400	500			
	NFR21GD <sup>p152</sup>	0805 (2012)														
	NFA31GD (4 circuits array) <sup>p153</sup>	1206 (3216)														

\* The derating of rated current is required for some items according to the operating temperature on each product page.

⚠Note • Please read rating and ⚠CAUTION (for storage, operating, rating, soldering, mounting and handling) in this catalog to prevent smoking and/or burning, etc.  
• This catalog has only typical specifications. Therefore, please approve our product specifications or transact the approval sheet for product specifications before ordering.

# DL

## Common Mode Choke Coils

Signal Lines Type	Series	Size Code in inch (in mm)	Common Mode Impedance (Ω) at 100MHz			Effective Frequency Range (Applicable Frequency Ranges are only for reference.)							
			100	500	1000	100kHz	1MHz	10MHz	100MHz	1GHz	10GHz		
						100kHz	1MHz	10MHz	100MHz	1GHz	10GHz		
For Audio Lines	DLM11G <sup>p184</sup>	0504 (1210)	600			[Frequency Range]							
	DLM11S <sup>p185</sup>	0504 (1210)	45	90		[Frequency Range]							
	DLP0QSN <sup>p186</sup>	025020 (0605)	60			[Frequency Range]							
	DLP0QSA <sup>p186</sup>	025020 (0605)	15 7	35		[Frequency Range]							
	DLP0NSC <sup>p187</sup>	03025 (0806)	28			[Frequency Range]							
	DLP0NSN <sup>p187</sup>	03025 (0806)	35 67	90 120		[Frequency Range]							
	DLP0NSA <sup>p187</sup>	03025 (0806)	15 7			[Frequency Range]							
	DLP11SN <sup>p189</sup>	0504 (1210)	67 90	120 160	240 200	280 330	[Frequency Range]						
	DLP11SA <sup>p189</sup>	0504 (1210)	35 67	90			[Frequency Range]						
	DLP11RN <sup>p190</sup>	0504 (1210)	45				[Frequency Range]						
	DLP11RB <sup>p190</sup>	0504 (1210)	15	40			[Frequency Range]						
	DLP11TB <sup>p191</sup>	0504 (1210)	80				[Frequency Range]						
	DLP31S <sup>p192</sup>	1206 (3216)	120	220	550	[Frequency Range]							
	DLP1NDN (2 circuits array) <sup>p193</sup>	05025 (1506)	35 67	90			[Frequency Range]						
	DLP2ADA (2 circuits array) <sup>p194</sup>	0804 (2010)	35 67	90			[Frequency Range]						
	DLP2ADN (2 circuits array) <sup>p194</sup>	0804 (2010)	90 67	120 160	240 200	280	[Frequency Range]						
	DLP31DN (2 circuits array) <sup>p196</sup>	1206 (3216)	90	130	200	320	440	[Frequency Range]					
	DLW21S <sup>p197</sup>	0805 (2012)	90 67	120 180	260	370	490 500	[Frequency Range]					
	DLW21H <sup>p199</sup>	0805 (2012)	90 67	120 180				[Frequency Range]					
	DLW31SN <sup>p200</sup>	1206 (3216)	90	160	260	600	1000	2200	[Frequency Range]				
DLW43SH <sup>p201</sup>	1812 (4532)							[Frequency Range]					
Universal Type [ Power Lines / Signal Lines ]	DLW5AH/DLW5BS* <sup>p177</sup>	2014 (5036) / 2020 (5050)		190	350	500	600	800	1000	1500	4000	[Frequency Range]	
	DLW5AT*/DLW5BT* <sup>p179</sup>	2014 (5036) / 2020 (5050)	50	110	230	330	500	1000	1400	850	1100	2700	[Frequency Range]

# PL

## Large Current Common Mode Choke Coil for Automotive Available

Large Current Type for Automotive Available	Series	Size Code in inch (in mm)	Common Mode Impedance (Ω) at 10MHz			Effective Frequency Range (Applicable Frequency Ranges are only for reference.)							
			100	500	1000	100kHz	1MHz	10MHz	100MHz	1GHz	10GHz		
						100kHz	1MHz	10MHz	100MHz	1GHz	10GHz		
	PLT10HH* <sup>p202</sup>	-	45	100	400	900	1000	[Frequency Range]					

# BNX

## Block EMIFIL®

Power Lines Type	Series	Height (mm)	Rated Voltage (Vdc)	Rated Current (A)	Effective Frequency Range (Applicable Frequency Ranges are only for reference.)							
					10kHz	100kHz	1MHz	10MHz	100MHz	1GHz	10GHz	
											10kHz	100kHz
SMD Type	BNX022* <sup>p221</sup>	3.1	50	10	[Frequency Range]							
	BNX023* <sup>p221</sup>	3.1	100	15	[Frequency Range]							
	BNX024* <sup>p221</sup>	3.5	50	15	[Frequency Range]							
	BNX025* <sup>p221</sup>	3.5	25	15	[Frequency Range]							
	BNX002 <sup>p223</sup>	13 max.	50	10	[Frequency Range]							
	BNX003 <sup>p223</sup>	13 max.	150	10	[Frequency Range]							
	BNX005 <sup>p223</sup>	13.5 max.	50	15	[Frequency Range]							
	BNX012* <sup>p224</sup>	8.5 max.	50	15	[Frequency Range]							
BNX016* <sup>p224</sup>	8.5 max.	25	15	[Frequency Range]								

\* The derating of rated current is required for some items according to the operating temperature on each product page.

△Note • Please read rating and △CAUTION (for storage, operating, rating, soldering, mounting and handling) in this catalog to prevent smoking and/or burning, etc.  
• This catalog has only typical specifications. Therefore, please approve our product specifications or transact the approval sheet for product specifications before ordering.

# BL□

## Chip Ferrite Bead

Series Introduction .....	14
Part Numbering .....	16
Series Line Up .....	18
Product Detail .....	24
⚠Caution/Notice .....	99
Soldering and Mounting .....	100
Packaging .....	104
Design Kits .....	105

Chip Ferrite Bead

Chip EMIFIL®

Chip Common Mode Choke Coil

Block Type EMIFIL®

Microwave Absorber

⚠Note • Please read rating and ⚠CAUTION (for storage, operating, rating, soldering, mounting and handling) in this catalog to prevent smoking and/or burning, etc.  
• This catalog has only typical specifications. Therefore, please approve our product specifications or transact the approval sheet for product specifications before ordering.

# BL   Series Introduction

## ● Example of Chip Ferrite Bead BLM Series Structure

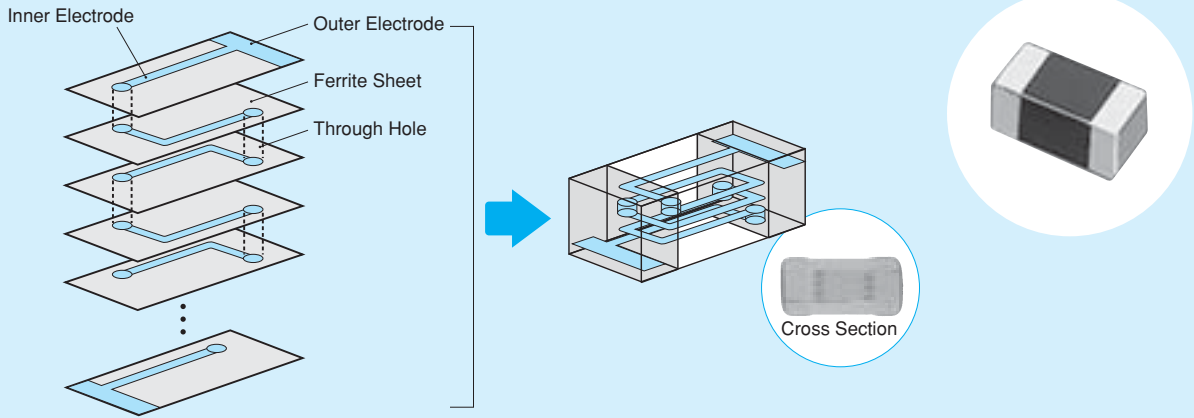

## ● Line Up Classification of Chip Ferrite Bead

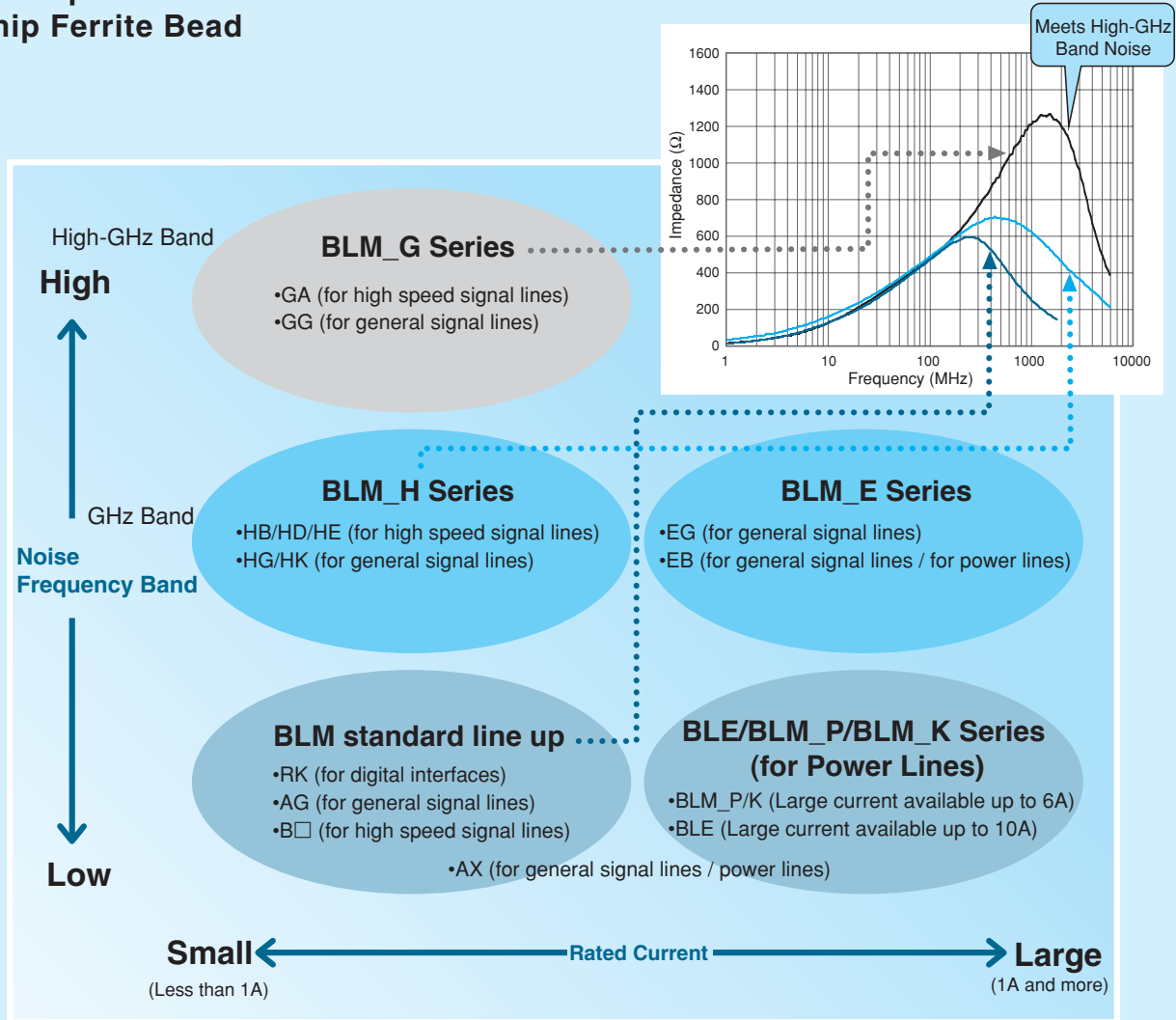

△Note • Please read rating and △CAUTION (for storage, operating, rating, soldering, mounting and handling) in this catalog to prevent smoking and/or burning, etc.  
 • This catalog has only typical specifications. Therefore, please approve our product specifications or transact the approval sheet for product specifications before ordering.

Chip Ferrite Bead  
Chip EMIFIL®  
Chip Common Mode Choke Coil  
Block Type EMIFIL®  
Microwave Absorber



### ●Difference between BLM A type and B type (HG type vs HD/HB/HE type)

A type: Impedance curve rises from low frequency range. Suppresses noise in a wide frequency range.  
 B type: Impedance curve rises sharply. Less damage to signal waveforms.

#### ■Comparison of Impedance Curve

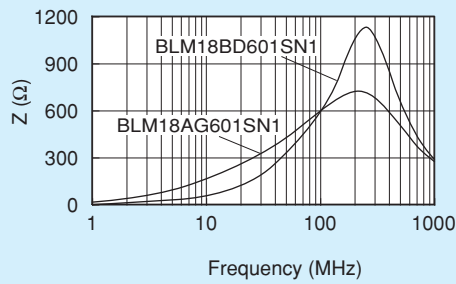

#### ■Comparison of Resistance Element

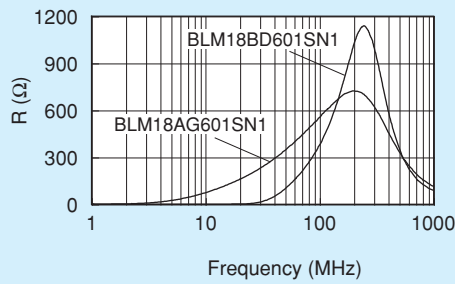

#### ■Comparison of Test Effect (25MHz)

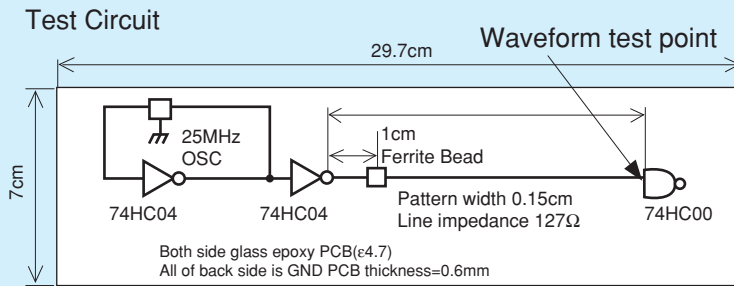

BLM\_B Series has less damage to high speed signal waveform.

Waveform

No filter

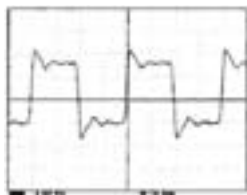

BLM18AG601SN1

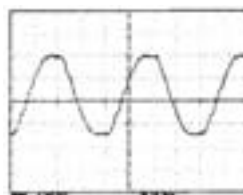

BLM18BD601SN1

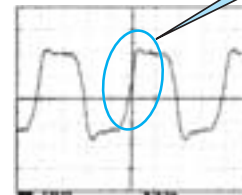

Spectrum

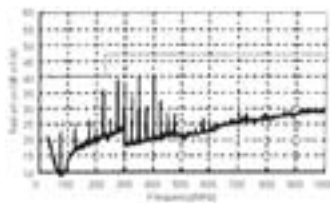
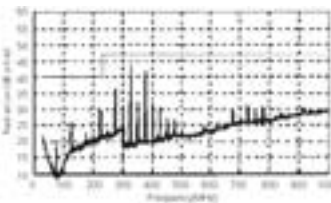
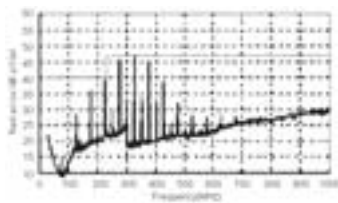

Spectrum has been reduced from low frequency range.

Noise frequency has been reduced without reducing signals of low frequency.

△Note • Please read rating and △CAUTION (for storage, operating, rating, soldering, mounting and handling) in this catalog to prevent smoking and/or burning, etc.  
 • This catalog has only typical specifications. Therefore, please approve our product specifications or transact the approval sheet for product specifications before ordering.

# BL   Chip Ferrite Bead Part Numbering

(Part Number) **BL M 18 AG 102 S N 1 D**  
 ① ② ③ ④ ⑤ ⑥ ⑦ ⑧ ⑨

## ① Product ID

Product ID	
BL	Chip Ferrite Beads

## ② Type

Code	Type
A	Array Type
E	DC Bias Characteristics Improved Type
M	Ferrite Bead Single Type

## ③ Dimensions (L×W)

Code	Dimensions (L×W)	EIA
02	0.4×0.2mm	01005
03	0.6×0.3mm	0201
15	1.0×0.5mm	0402
18	1.6×0.8mm	0603
2A	2.0×1.0mm	0804
21	2.0×1.25mm	0805
31	3.2×1.6mm	1206
32	3.2×2.5mm	1210
41	4.5×1.6mm	1806

## ④ Characteristics/Applications

Code *1	Characteristics/Applications	Series
AG	For General Use	BLM03/15/18/21, BLA2A/31
AX		BLM02/03/15
TG		BLM18
BA	For High-speed Signal Lines	BLM15/18
BB		BLM03/15/18/21, BLA2A
BC		BLM03/15
BD		BLM03/15/18/21, BLA2A/31
BX		BLM02/15
PD		BLM15
PG		BLM03/15/18/21/31/41
PN	For Power Lines	BLE32
PX		BLM03/15
KG		BLM18
SG	For Power Lines (Low DC Resistance Type)	BLM18
RK	For Digital Interface	BLM18/21
HG	For GHz Band General Use	BLM03/15/18
EB	For GHz Band High-speed Signal Lines (Low Direct Current Type)	BLM03
EG	For GHz Band General Use (Low DC Resistance Type)	BLM15/18
HB	For GHz Band High-speed Signal Lines	BLM03/15/18
HD		BLM03/15/18
HE		BLM18
HK	For GHz Band Digital Interface	BLM18
GA	For High-GHz Band High-speed Signal Lines	BLM15
GG	For High-GHz Band General Use	BLM15/18

\*1 Frequency characteristics vary with each code.

## ⑤ Impedance

Expressed by three figures. The unit is in ohm ( $\Omega$ ) at 100MHz. The first and second figures are significant digits, and the third figure expresses the number of zeros that follow the two figures.

## ⑥ Electrode

Expressed by a letter.

Ex.)	Code	Electrode
	S/T	Sn Plating
	A	Au Plating

## ⑦ Category

Code	Category
N	Standard Type

## ⑧ Number of Circuits

Code	Number of Circuits
1	1 Circuit
4	4 Circuits

Continued on the following page.

△Note • Please read rating and △CAUTION (for storage, operating, rating, soldering, mounting and handling) in this catalog to prevent smoking and/or burning, etc.  
 • This catalog has only typical specifications. Therefore, please approve our product specifications or transact the approval sheet for product specifications before ordering.

## ⑨ Packaging

Code	Packaging	Series
<b>K</b>	Embossed Taping (ø330mm Reel)	<b>BLE, BLM21<sup>*1</sup>/31/41</b>
<b>L</b>	Embossed Taping (ø180mm Reel)	
<b>B</b>	Bulk	All Series
<b>J</b>	Paper Taping (ø330mm Reel)	<b>BLM03/15/18<sup>*3</sup>/21<sup>*2</sup>, BLA2A/31</b>
<b>D</b>	Paper Taping (ø180mm Reel)	<b>BLM02/03/15/18/21<sup>*2</sup>, BLA2A/31</b>

\*1 BLM21BD222SN1/BLM21BD272SN1 only.

\*2 Except for BLM21BD222SN1/BLM21BD272SN1

\*3 Except for BLM18T

# BL   Chip Ferrite Bead Series Line Up

Size Code (in inch (in mm))	Thickness (mm)	Type	Part Number	Impedance		Rated Current	New	Kit	≥1A ≥3A ≥10A	GHz Hi-GHz	Flow	RefFlow
				at 100MHz/20°C	at 1GHz/20°C							
01005 (0402)	0.2	Universal Type [Power lines/Signal lines]	p24 BLM02AX100SN1	10ohm±5ohm	-	750mA		Kit				RefFlow
	0.2		BLM02AX700SN1	70ohm±25%	-	300mA		Kit				RefFlow
	0.2		BLM02AX121SN1	120ohm±25%	-	250mA		Kit				RefFlow
	0.2	For High Speed Signal Lines	p26 BLM02BX151SN1	150ohm±25%	-	200mA	New					RefFlow
	0.3	For General Signal Lines	p32 BLM03AG100SN1	10ohm(Typ.)	-	500mA		Kit				RefFlow
	0.3		BLM03AG700SN1	70ohm(Typ.)	-	200mA		Kit				RefFlow
	0.3		BLM03AG800SN1	80ohm±25%	-	200mA		Kit				RefFlow
	0.3		BLM03AG121SN1	120ohm±25%	-	200mA		Kit				RefFlow
	0.3		BLM03AG241SN1	240ohm±25%	-	200mA		Kit				RefFlow
0.3	BLM03AG601SN1		600ohm±25%	-	100mA		Kit				RefFlow	
0.3	BLM03AG102SN1		1000ohm±25%	-	100mA		Kit				RefFlow	
0.3	Universal Type [Power lines/Signal lines]	p30 BLM03AX100SN1	10ohm(Typ.)	-	1000mA		Kit	≥1A			RefFlow	
0.3		BLM03AX800SN1	80ohm±25%	-	500mA		Kit				RefFlow	
0.3		BLM03AX121SN1	120ohm±25%	-	450mA		Kit				RefFlow	
0.3		BLM03AX241SN1	240ohm±25%	-	350mA		Kit				RefFlow	
0.3		BLM03AX601SN1	600ohm±25%	-	250mA		Kit				RefFlow	
0.3		BLM03AX102SN1	1000ohm±25%	-	200mA		Kit				RefFlow	
0201 (0603)	0.3	For High Speed Signal Lines (Sharp Impedance Curve)	p34 BLM03BD750SN1	75ohm±25%	-	300mA		Kit				RefFlow
	0.3		BLM03BD121SN1	120ohm±25%	-	250mA		Kit				RefFlow
	0.3		BLM03BD241SN1	240ohm±25%	-	200mA		Kit				RefFlow
	0.3		BLM03BD471SN1	470ohm±25%	-	215mA		Kit				RefFlow
	0.3		BLM03BD601SN1	600ohm±25%	-	200mA		Kit				RefFlow
	0.3		BLM03BB100SN1	10ohm±25%	-	300mA		Kit				RefFlow
	0.3		BLM03BB220SN1	22ohm±25%	-	200mA		Kit				RefFlow
	0.3		BLM03BB470SN1	47ohm±25%	-	200mA		Kit				RefFlow
	0.3		BLM03BB750SN1	75ohm±25%	-	200mA		Kit				RefFlow
	0.3		BLM03BB121SN1	120ohm±25%	-	100mA		Kit				RefFlow
	0.3		BLM03BC330SN1	33ohm±25%	-	150mA		Kit				RefFlow
	0.3		BLM03BC560SN1	56ohm±25%	-	100mA		Kit				RefFlow
	0.3	BLM03BC800SN1	80ohm±25%	-	100mA		Kit				RefFlow	
	0.3	For Power Lines	p27 BLM03PG220SN1	22ohm±25%	-	900mA		Kit				RefFlow
	0.3		BLM03PG330SN1	33ohm±25%	-	750mA		Kit				RefFlow
	0.3		p28 BLM03PX220SN1	22ohm±25%	-	1800mA		Kit	≥1A			RefFlow
	0.3		BLM03PX330SN1	33ohm±25%	-	1500mA		Kit	≥1A			RefFlow
	0.3		BLM03PX800SN1	80ohm±25%	-	1000mA		Kit	≥1A			RefFlow
0.3	For GHz Band Noise		p85 BLM03HG601SN1	600ohm±25%	1000ohm±40%	150mA		Kit		GHz		RefFlow
0.3		BLM03HG102SN1	1000ohm±25%	1800ohm±40%	125mA		Kit		GHz		RefFlow	
0.3		BLM03HG122SN1	1200ohm±25%	2000ohm±40%	100mA	New			GHz		RefFlow	
0.3		Universal Type [Power lines/Signal lines]	p87 BLM03EB250SN1	25ohm±25%	105ohm±40%	600mA		Kit		GHz		RefFlow
0.3			BLM03EB500SN1	50ohm±25%	255ohm±40%	400mA		Kit		GHz		RefFlow
0.3		For High Speed Signal Lines	p85 BLM03HD331SN1	330ohm±25%	750ohm±40%	200mA		Kit		GHz		RefFlow
0.3	BLM03HD471SN1		470ohm±25%	1000ohm±40%	175mA		Kit		GHz		RefFlow	
0.3	BLM03HD601SN1		600ohm±25%	1500ohm±40%	150mA		Kit		GHz		RefFlow	
0.3	BLM03HD102SN1		1000ohm±25%	2300ohm±40%	120mA		Kit		GHz		RefFlow	
0.3	BLM03HB191SN1		190ohm±25%	1150ohm±40%	150mA		Kit		GHz		RefFlow	
0.3												
0402 (1005)	0.5	For General Signal Lines	p42 BLM15AG100SN1	10ohm(Typ.)	-	1000mA		Kit	≥1A			RefFlow
	0.5		BLM15AG700SN1	70ohm(Typ.)	-	600mA		Kit				RefFlow
	0.5		BLM15AG121SN1	120ohm±25%	-	550mA		Kit				RefFlow
	0.5		BLM15AG221SN1	220ohm±25%	-	450mA		Kit				RefFlow
	0.5		BLM15AG601SN1	600ohm±25%	-	300mA		Kit				RefFlow
	0.5		BLM15AG102SN1	1000ohm±25%	-	300mA		Kit				RefFlow
	0.5	Universal Type [Power lines/Signal lines]	p40 BLM15AX100SN1	10ohm±5ohm	-	1740mA		Kit	≥1A			RefFlow
	0.5		BLM15AX300SN1	30ohm±25%	-	1100mA		Kit	≥1A			RefFlow
	0.5		BLM15AX700SN1	70ohm±25%	-	780mA		Kit				RefFlow
	0.5		BLM15AX121SN1	120ohm±25%	-	700mA		Kit				RefFlow
	0.5		BLM15AX221SN1	220ohm±25%	-	600mA		Kit				RefFlow
	0.5		BLM15AX601SN1	600ohm±25%	-	500mA		Kit				RefFlow
	0.5		BLM15AX102SN1	1000ohm±25%	-	350mA		Kit				RefFlow

Continued on the following page.

△Note • Please read rating and △CAUTION (for storage, operating, rating, soldering, mounting and handling) in this catalog to prevent smoking and/or burning, etc.  
• This catalog has only typical specifications. Therefore, please approve our product specifications or transact the approval sheet for product specifications before ordering.

Chip Ferrite Bead  
Chip EMIFIL®  
Chip Common Mode Choke Coil  
Block Type EMIFIL®  
Microwave Absorber

Size Code (in inch (in mm))	Thickness (mm)	Type	Part Number	Impedance		Rated Current	New	Kit	≥1A ≥3A ≥10A	GHz Hi-GHz	Flow	RefFlow	
				at 100MHz/20°C	at 1GHz/20°C								
0402 (1005)	0.5	For High Speed Signal Lines (Sharp Impedance Curve)	p44	BLM15BX750SN1	75ohm±25%	-	600mA	Kit				RefFlow	
	0.5			BLM15BX121SN1	120ohm±25%	-	600mA	Kit				RefFlow	
	0.5			BLM15BX221SN1	220ohm±25%	-	450mA	Kit				RefFlow	
	0.5			BLM15BX471SN1	470ohm±25%	-	350mA	Kit				RefFlow	
	0.5			BLM15BX601SN1	600ohm±25%	-	350mA	Kit				RefFlow	
	0.5			BLM15BX102SN1	1000ohm±25%	-	300mA	Kit				RefFlow	
	0.5			BLM15BX182SN1	1800ohm±25%	-	250mA	Kit				RefFlow	
	0.5			p46	BLM15BD750SN1	75ohm±25%	-	300mA	Kit				RefFlow
	0.5				BLM15BD121SN1	120ohm±25%	-	300mA	Kit				RefFlow
	0.5				BLM15BD221SN1	220ohm±25%	-	300mA	Kit				RefFlow
	0.5				BLM15BD471SN1	470ohm±25%	-	200mA	Kit				RefFlow
	0.5				BLM15BD601SN1	600ohm±25%	-	200mA	Kit				RefFlow
	0.5				BLM15BD102SN1	1000ohm±25%	-	200mA	Kit				RefFlow
	0.5				BLM15BD182SN1	1800ohm±25%	-	100mA	Kit				RefFlow
	0.5				BLM15BB050SN1	5ohm±25%	-	500mA	Kit				RefFlow
	0.5				BLM15BB100SN1	10ohm±25%	-	300mA	Kit				RefFlow
	0.5				BLM15BB220SN1	22ohm±25%	-	300mA	Kit				RefFlow
	0.5			BLM15BB470SN1	47ohm±25%	-	300mA	Kit				RefFlow	
	0.5			BLM15BB750SN1	75ohm±25%	-	300mA	Kit				RefFlow	
	0.5			BLM15BB121SN1	120ohm±25%	-	300mA	Kit				RefFlow	
	0.5		BLM15BB221SN1	220ohm±25%	-	200mA	Kit				RefFlow		
	0.5		BLM15BC121SN1	120ohm±25%	-	350mA	Kit				RefFlow		
	0.5		BLM15BC241SN1	240ohm±25%	-	250mA	Kit				RefFlow		
	0.5		BLM15BA050SN1	5ohm±25%	-	300mA	Kit				RefFlow		
	0.5		BLM15BA100SN1	10ohm±25%	-	300mA	Kit				RefFlow		
	0.5		BLM15BA220SN1	22ohm±25%	-	300mA	Kit				RefFlow		
	0.5		BLM15BA330SN1	33ohm±25%	-	300mA	Kit				RefFlow		
	0.5		BLM15BA470SN1	47ohm±25%	-	200mA	Kit				RefFlow		
	0.5		BLM15BA750SN1	75ohm±25%	-	200mA	Kit				RefFlow		
	0.5		For Power Lines	p36	BLM15PX330SN1	33ohm±25%	-	3000mA	Kit	≥3A			RefFlow
	0.5				BLM15PX600SN1	60ohm±25%	-	2500mA	Kit	≥1A			RefFlow
	0.5				BLM15PX800SN1	80ohm±25%	-	2300mA	Kit	≥1A			RefFlow
	0.5				BLM15PX121SN1	120ohm±25%	-	2000mA	Kit	≥1A			RefFlow
	0.5				BLM15PX181SN1	180ohm±25%	-	1500mA	Kit	≥1A			RefFlow
	0.5				BLM15PX221SN1	220ohm±25%	-	1400mA	Kit	≥1A			RefFlow
	0.5				BLM15PX331SN1	330ohm±25%	-	1200mA	Kit	≥1A			RefFlow
	0.5				BLM15PX471SN1	470ohm±25%	-	1000mA	Kit	≥1A			RefFlow
	0.5				BLM15PX601SN1	600ohm±25%	-	900mA	Kit				RefFlow
	0.5				p38	BLM15PG100SN1	10ohm(Typ.)	-	1000mA	Kit	≥1A		
	0.5		BLM15PD300SN1	30ohm±25%		-	2200mA	Kit	≥1A			RefFlow	
0.5	BLM15PD600SN1	60ohm±25%	-	1700mA		Kit	≥1A			RefFlow			
0.5	BLM15PD800SN1	80ohm±25%	-	1500mA		Kit	≥1A			RefFlow			
0.5	BLM15PD121SN1	120ohm±25%	-	1300mA		Kit	≥1A			RefFlow			
0.5	For GHz Band Noise	p88	BLM15HG601SN1	600ohm±25%	1000ohm±40%	300mA	Kit		GHz		RefFlow		
0.5			BLM15HG102SN1	1000ohm±25%	1400ohm±40%	250mA	Kit			GHz		RefFlow	
0.5		For High Speed Signal Lines (Sharp Impedance Curve)	p88	BLM15HD601SN1	600ohm±25%	1400ohm±40%	300mA	Kit		GHz		RefFlow	
0.5				BLM15HD102SN1	1000ohm±25%	2000ohm±40%	250mA	Kit			GHz		RefFlow
0.5				BLM15HD182SN1	1800ohm±25%	2700ohm±40%	200mA	Kit			GHz		RefFlow
0.5				BLM15HB121SN1	120ohm±25%	500ohm±40%	300mA	Kit			GHz		RefFlow
0.5				BLM15HB221SN1	220ohm±25%	900ohm±40%	250mA	Kit			GHz		RefFlow
0.5				BLM15EG121SN1	120ohm±25%	145ohm(Typ.)	1500mA	Kit	≥1A		GHz		RefFlow
0.5		For High-GHz Band Noise	p91	BLM15EG221SN1	220ohm±25%	270ohm(Typ.)	700mA	Kit		GHz		RefFlow	
0.5				For General Signal Lines	BLM15GG221SN1	220ohm±25%	600ohm±40%	300mA	Kit		Hi-GHz		RefFlow
0.5	BLM15GG471SN1				470ohm±25%	1200ohm±40%	200mA	Kit			Hi-GHz		RefFlow
0.5	For High Speed Signal Lines			p91	BLM15GA750SN1	75ohm±25%	1000ohm±40%	200mA	Kit		Hi-GHz		RefFlow

Continued on the following page. ↗

⚠Note • Please read rating and ⚠CAUTION (for storage, operating, rating, soldering, mounting and handling) in this catalog to prevent smoking and/or burning, etc.  
• This catalog has only typical specifications. Therefore, please approve our product specifications or transact the approval sheet for product specifications before ordering.

Size Code (in inch in mm)	Thickness (mm)	Type	Part Number	Impedance		Rated Current	New	Kit	≥1A ≥3A ≥10A	GHz	F <sub>low</sub>	R <sub>eflow</sub>	
				at 100MHz/20°C	at 1GHz/20°C								
0603 (1608)	0.8	For General Signal Lines	p56 BLM18AG121SN1	120ohm±25%	-	500mA		Kit			F <sub>low</sub>	R <sub>eflow</sub>	
	0.8		p56 BLM18AG151SN1	150ohm±25%	-	500mA		Kit			F <sub>low</sub>	R <sub>eflow</sub>	
	0.8		p56 BLM18AG221SN1	220ohm±25%	-	500mA		Kit			F <sub>low</sub>	R <sub>eflow</sub>	
	0.8		p56 BLM18AG331SN1	330ohm±25%	-	500mA		Kit			F <sub>low</sub>	R <sub>eflow</sub>	
	0.8		p56 BLM18AG471SN1	470ohm±25%	-	500mA		Kit			F <sub>low</sub>	R <sub>eflow</sub>	
	0.8		p56 BLM18AG601SN1	600ohm±25%	-	500mA		Kit			F <sub>low</sub>	R <sub>eflow</sub>	
	0.8		p56 BLM18AG102SN1	1000ohm±25%	-	400mA		Kit			F <sub>low</sub>	R <sub>eflow</sub>	
	0.6		p62	p62 BLM18TG121TN1	120ohm±25%	-	200mA					F <sub>low</sub>	R <sub>eflow</sub>
	0.6			p62 BLM18TG221TN1	220ohm±25%	-	200mA					F <sub>low</sub>	R <sub>eflow</sub>
	0.6			p62 BLM18TG601TN1	600ohm±25%	-	200mA					F <sub>low</sub>	R <sub>eflow</sub>
	0.6			p62 BLM18TG102TN1	1000ohm±25%	-	100mA					F <sub>low</sub>	R <sub>eflow</sub>
	0.8		For High Speed Signal Lines (Sharp Impedance Curve)	p58 BLM18BD470SN1	47ohm±25%	-	500mA		Kit			F <sub>low</sub>	R <sub>eflow</sub>
	0.8			p58 BLM18BD121SN1	120ohm±25%	-	200mA		Kit			F <sub>low</sub>	R <sub>eflow</sub>
	0.8			p58 BLM18BD151SN1	150ohm±25%	-	200mA		Kit			F <sub>low</sub>	R <sub>eflow</sub>
	0.8			p58 BLM18BD221SN1	220ohm±25%	-	200mA		Kit			F <sub>low</sub>	R <sub>eflow</sub>
	0.8	p58 BLM18BD331SN1		330ohm±25%	-	200mA		Kit			F <sub>low</sub>	R <sub>eflow</sub>	
	0.8	p58 BLM18BD421SN1		420ohm±25%	-	200mA		Kit			F <sub>low</sub>	R <sub>eflow</sub>	
	0.8	p58 BLM18BD471SN1		470ohm±25%	-	200mA		Kit			F <sub>low</sub>	R <sub>eflow</sub>	
	0.8	p58 BLM18BD601SN1		600ohm±25%	-	200mA		Kit			F <sub>low</sub>	R <sub>eflow</sub>	
	0.8	p58 BLM18BD102SN1		1000ohm±25%	-	100mA		Kit			F <sub>low</sub>	R <sub>eflow</sub>	
	0.8	p58 BLM18BD152SN1		1500ohm±25%	-	50mA		Kit			F <sub>low</sub>	R <sub>eflow</sub>	
	0.8	p58 BLM18BD182SN1		1800ohm±25%	-	50mA		Kit			F <sub>low</sub>	R <sub>eflow</sub>	
	0.8	p58 BLM18BD222SN1		2200ohm±25%	-	50mA		Kit			F <sub>low</sub>	R <sub>eflow</sub>	
	0.8	p58 BLM18BD252SN1		2500ohm±25%	-	50mA		Kit			F <sub>low</sub>	R <sub>eflow</sub>	
	0.8	p58 BLM18BB050SN1		5ohm±25%	-	700mA		Kit			F <sub>low</sub>	R <sub>eflow</sub>	
	0.8	p58 BLM18BB100SN1		10ohm±25%	-	700mA		Kit			F <sub>low</sub>	R <sub>eflow</sub>	
	0.8	p58 BLM18BB220SN1		22ohm±25%	-	600mA		Kit			F <sub>low</sub>	R <sub>eflow</sub>	
	0.8	p58 BLM18BB470SN1		47ohm±25%	-	550mA		Kit			F <sub>low</sub>	R <sub>eflow</sub>	
	0.8	p58 BLM18BB600SN1		60ohm±25%	-	550mA		Kit			F <sub>low</sub>	R <sub>eflow</sub>	
	0.8	p58 BLM18BB750SN1		75ohm±25%	-	500mA		Kit			F <sub>low</sub>	R <sub>eflow</sub>	
	0.8	p58 BLM18BB121SN1		120ohm±25%	-	500mA		Kit			F <sub>low</sub>	R <sub>eflow</sub>	
	0.8	p58 BLM18BB141SN1		140ohm±25%	-	450mA					F <sub>low</sub>	R <sub>eflow</sub>	
	0.8	p58 BLM18BB151SN1		150ohm±25%	-	450mA		Kit			F <sub>low</sub>	R <sub>eflow</sub>	
	0.8	p58 BLM18BB221SN1		220ohm±25%	-	450mA		Kit			F <sub>low</sub>	R <sub>eflow</sub>	
	0.8	p58 BLM18BB331SN1		330ohm±25%	-	400mA		Kit			F <sub>low</sub>	R <sub>eflow</sub>	
	0.8	p58 BLM18BB471SN1		470ohm±25%	-	300mA		Kit			F <sub>low</sub>	R <sub>eflow</sub>	
	0.8	p58 BLM18BA050SN1		5ohm±25%	-	500mA		Kit			F <sub>low</sub>	R <sub>eflow</sub>	
	0.8	p58 BLM18BA100SN1		10ohm±25%	-	500mA		Kit			F <sub>low</sub>	R <sub>eflow</sub>	
	0.8	p58 BLM18BA220SN1		22ohm±25%	-	500mA					F <sub>low</sub>	R <sub>eflow</sub>	
	0.8	p58 BLM18BA470SN1		47ohm±25%	-	300mA		Kit			F <sub>low</sub>	R <sub>eflow</sub>	
	0.8	p58 BLM18BA750SN1		75ohm±25%	-	300mA		Kit			F <sub>low</sub>	R <sub>eflow</sub>	
	0.8	p58 BLM18BA121SN1	120ohm±25%	-	200mA		Kit			F <sub>low</sub>	R <sub>eflow</sub>		
	0.8	For Digital Interface Lines	p63 BLM18RK121SN1	120ohm±25%	-	200mA					F <sub>low</sub>	R <sub>eflow</sub>	
	0.8		p63 BLM18RK221SN1	220ohm±25%	-	200mA					F <sub>low</sub>	R <sub>eflow</sub>	
	0.8		p63 BLM18RK471SN1	470ohm±25%	-	200mA					F <sub>low</sub>	R <sub>eflow</sub>	
0.8	p63 BLM18RK601SN1		600ohm±25%	-	200mA					F <sub>low</sub>	R <sub>eflow</sub>		
0.8	p63 BLM18RK102SN1		1000ohm±25%	-	200mA					F <sub>low</sub>	R <sub>eflow</sub>		

Continued on the following page. ↗

△Note • Please read rating and △CAUTION (for storage, operating, rating, soldering, mounting and handling) in this catalog to prevent smoking and/or burning, etc.  
 • This catalog has only typical specifications. Therefore, please approve our product specifications or transact the approval sheet for product specifications before ordering.

Chip Ferrite Bead  
Chip EMIFIL®  
Chip Common Mode Choke Coil  
Block Type EMIFIL®  
Microwave Absorber

Size Code (in mm)	Thickness (mm)	Type	Part Number	Impedance		Rated Current	New	Kit	≥1A ≥3A ≥10A	GHz Hz	F <sub>low</sub>	R <sub>eflow</sub>
				at 100MHz/20°C	at 1GHz/20°C							
6003 (1608)	0.8	Standard Type	p50 BLM18PG300SN1	30ohm(Typ.)	-	1000mA	Kit	≥1A			F <sub>low</sub>	R <sub>eflow</sub>
	0.8		p50 BLM18PG330SN1	33ohm±25%	-	3000mA	Kit	≥3A			F <sub>low</sub>	R <sub>eflow</sub>
	0.8		p50 BLM18PG600SN1	60ohm(Typ.)	-	500mA	Kit				F <sub>low</sub>	R <sub>eflow</sub>
	0.8		p50 BLM18PG121SN1	120ohm±25%	-	2000mA	Kit	≥1A			F <sub>low</sub>	R <sub>eflow</sub>
	0.8		p50 BLM18PG181SN1	180ohm±25%	-	1500mA	Kit	≥1A			F <sub>low</sub>	R <sub>eflow</sub>
	0.8		p50 BLM18PG221SN1	220ohm±25%	-	1400mA	Kit	≥1A			F <sub>low</sub>	R <sub>eflow</sub>
	0.8		p50 BLM18PG331SN1	330ohm±25%	-	1200mA	Kit	≥1A			F <sub>low</sub>	R <sub>eflow</sub>
	0.8		p50 BLM18PG471SN1	470ohm±25%	-	1000mA	Kit	≥1A			F <sub>low</sub>	R <sub>eflow</sub>
	0.6	For Power Lines	p52 BLM18KG260TN1	26ohm±25%	-	6000mA	Kit	≥3A			F <sub>low</sub>	R <sub>eflow</sub>
	0.6		p52 BLM18KG300TN1	30ohm±25%	-	5000mA	Kit	≥3A			F <sub>low</sub>	R <sub>eflow</sub>
	0.6		p52 BLM18KG700TN1	70ohm±25%	-	3500mA	Kit	≥3A			F <sub>low</sub>	R <sub>eflow</sub>
	0.6		p52 BLM18KG101TN1	100ohm±25%	-	3000mA	Kit	≥3A			F <sub>low</sub>	R <sub>eflow</sub>
	0.6		p52 BLM18KG121TN1	120ohm±25%	-	3000mA	Kit	≥3A			F <sub>low</sub>	R <sub>eflow</sub>
	0.8		p52 BLM18KG221SN1	220ohm±25%	-	2200mA	Kit	≥1A			F <sub>low</sub>	R <sub>eflow</sub>
	0.8		p52 BLM18KG331SN1	330ohm±25%	-	1700mA	Kit	≥1A			F <sub>low</sub>	R <sub>eflow</sub>
	0.8		p52 BLM18KG471SN1	470ohm±25%	-	1500mA	Kit	≥1A			F <sub>low</sub>	R <sub>eflow</sub>
	0.8	Low DC Resistance Type	p54 BLM18KG601SN1	600ohm±25%	-	1300mA	Kit	≥1A			F <sub>low</sub>	R <sub>eflow</sub>
	0.5		p54 BLM18SG260TN1	26ohm±25%	-	6000mA	Kit	≥3A			F <sub>low</sub>	R <sub>eflow</sub>
	0.5		p54 BLM18SG700TN1	70ohm±25%	-	4000mA	Kit	≥3A			F <sub>low</sub>	R <sub>eflow</sub>
	0.5		p54 BLM18SG121TN1	120ohm±25%	-	3000mA	Kit	≥3A			F <sub>low</sub>	R <sub>eflow</sub>
	0.5	p54 BLM18SG221TN1	220ohm±25%	-	2500mA	Kit	≥1A			F <sub>low</sub>	R <sub>eflow</sub>	
	0.5	p54 BLM18SG331TN1	330ohm±25%	-	1500mA	Kit	≥1A			F <sub>low</sub>	R <sub>eflow</sub>	
	0.8	For GHz Band Noise	p92 For General Signal Lines	p92 BLM18HG471SN1	470ohm±25%	600ohm(Typ.)	200mA	Kit		GHz	F <sub>low</sub>	R <sub>eflow</sub>
	0.8		p92 BLM18HG601SN1	600ohm±25%	700ohm(Typ.)	200mA	Kit		GHz	F <sub>low</sub>	R <sub>eflow</sub>	
	0.8		p92 BLM18HG102SN1	1000ohm±25%	1000ohm(Typ.)	100mA	Kit		GHz	F <sub>low</sub>	R <sub>eflow</sub>	
	0.8		p92 For High Speed Signal Lines (Sharp Impedance Curve)	p92 BLM18HE601SN1	600ohm±25%	600ohm(Typ.)	800mA	Kit		GHz	F <sub>low</sub>	R <sub>eflow</sub>
	0.8		p92 BLM18HE102SN1	1000ohm±25%	1000ohm(Typ.)	600mA	Kit		GHz	F <sub>low</sub>	R <sub>eflow</sub>	
	0.8		p92 BLM18HE152SN1	1500ohm±25%	1500ohm(Typ.)	500mA	Kit		GHz	F <sub>low</sub>	R <sub>eflow</sub>	
	0.8		p92 BLM18HD471SN1	470ohm±25%	1000ohm(Typ.)	100mA	Kit		GHz	F <sub>low</sub>	R <sub>eflow</sub>	
	0.8		p92 BLM18HD601SN1	600ohm±25%	1200ohm(Typ.)	100mA	Kit		GHz	F <sub>low</sub>	R <sub>eflow</sub>	
	0.8		p92 BLM18HD102SN1	1000ohm±25%	1700ohm(Typ.)	50mA	Kit		GHz	F <sub>low</sub>	R <sub>eflow</sub>	
	0.8		p92 BLM18HB121SN1	120ohm±25%	500ohm±40%	200mA	Kit		GHz	F <sub>low</sub>	R <sub>eflow</sub>	
	0.8		p92 BLM18HB221SN1	220ohm±25%	1100ohm±40%	100mA	Kit		GHz	F <sub>low</sub>	R <sub>eflow</sub>	
	0.8		p92 BLM18HB331SN1	330ohm±25%	1600ohm±40%	50mA	Kit		GHz	F <sub>low</sub>	R <sub>eflow</sub>	
	0.8		p92 For Digital Interface Lines	p92 BLM18HK331SN1	330ohm±25%	400ohm±40%	200mA	Kit		GHz	F <sub>low</sub>	R <sub>eflow</sub>
	0.8		p92 BLM18HK471SN1	470ohm±25%	600ohm±40%	200mA	Kit		GHz	F <sub>low</sub>	R <sub>eflow</sub>	
	0.8		p92 BLM18HK601SN1	600ohm±25%	700ohm±40%	100mA	Kit		GHz	F <sub>low</sub>	R <sub>eflow</sub>	
	0.8		p92 BLM18HK102SN1	1000ohm±25%	1200ohm±40%	50mA	Kit		GHz	F <sub>low</sub>	R <sub>eflow</sub>	
	0.5	Universal Type [Power lines/Signal lines]	p96 BLM18EG101TN1	100ohm±25%	140ohm(Typ.)	2000mA	Kit	≥1A	GHz	F <sub>low</sub>	R <sub>eflow</sub>	
	0.8		p96 BLM18EG121SN1	120ohm±25%	145ohm(Typ.)	2000mA	Kit	≥1A	GHz	F <sub>low</sub>	R <sub>eflow</sub>	
0.8	p96 BLM18EG221SN1		220ohm±25%	260ohm(Typ.)	2000mA	Kit	≥1A	GHz	F <sub>low</sub>	R <sub>eflow</sub>		
0.5	p96 BLM18EG221TN1		220ohm±25%	300ohm(Typ.)	1000mA	Kit	≥1A	GHz	F <sub>low</sub>	R <sub>eflow</sub>		
0.5	p96 BLM18EG331TN1		330ohm±25%	450ohm(Typ.)	500mA	Kit		GHz	F <sub>low</sub>	R <sub>eflow</sub>		
0.5	p96 BLM18EG391TN1		390ohm±25%	520ohm(Typ.)	500mA	Kit		GHz	F <sub>low</sub>	R <sub>eflow</sub>		
0.8	p96 BLM18EG471SN1		470ohm±25%	550ohm(Typ.)	500mA	Kit		GHz	F <sub>low</sub>	R <sub>eflow</sub>		
0.8	p96 BLM18EG601SN1		600ohm±25%	700ohm(Typ.)	500mA	Kit		GHz	F <sub>low</sub>	R <sub>eflow</sub>		
0.8	For High-GHz Band Noise	p98 BLM18GG471SN1	470ohm±25%	1800ohm±30%	200mA	Kit		Hz		R <sub>eflow</sub>		
0805 (2012)	0.85	For General Signal Lines	p68 BLM21AG121SN1	120ohm±25%	-	800mA	Kit				F <sub>low</sub>	R <sub>eflow</sub>
	0.85		p68 BLM21AG151SN1	150ohm±25%	-	800mA	Kit				F <sub>low</sub>	R <sub>eflow</sub>
	0.85		p68 BLM21AG221SN1	220ohm±25%	-	800mA	Kit				F <sub>low</sub>	R <sub>eflow</sub>
	0.85		p68 BLM21AG331SN1	330ohm±25%	-	700mA	Kit				F <sub>low</sub>	R <sub>eflow</sub>
	0.85		p68 BLM21AG471SN1	470ohm±25%	-	700mA	Kit				F <sub>low</sub>	R <sub>eflow</sub>
	0.85		p68 BLM21AG601SN1	600ohm±25%	-	600mA	Kit				F <sub>low</sub>	R <sub>eflow</sub>
	0.85		p68 BLM21AG102SN1	1000ohm±25%	-	500mA	Kit				F <sub>low</sub>	R <sub>eflow</sub>

Continued on the following page.

△Note • Please read rating and △CAUTION (for storage, operating, rating, soldering, mounting and handling) in this catalog to prevent smoking and/or burning, etc.  
 • This catalog has only typical specifications. Therefore, please approve our product specifications or transact the approval sheet for product specifications before ordering.



























BL Chip Ferrite Bead Series Line Up

Size Code (in mm)	Thickness (mm)	Type	Part Number	Impedance		Rated Current	New	Kit	$\geq 1A$ $\geq 3A$ $\geq 10A$	GHz	F <sub>low</sub>	R <sub>eflow</sub>	
				at 100MHz/20°C	at 1GHz/20°C								
0805 (2012)	0.85	For High Speed Signal Lines (Sharp Impedance Curve)	p70 BLM21BD121SN1	120ohm±25%	-	200mA		Kit			F <sub>low</sub>	R <sub>eflow</sub>	
	0.85		BLM21BD151SN1	150ohm±25%	-	200mA					F <sub>low</sub>	R <sub>eflow</sub>	
	0.85		BLM21BD221SN1	220ohm±25%	-	200mA		Kit			F <sub>low</sub>	R <sub>eflow</sub>	
	0.85		BLM21BD331SN1	330ohm±25%	-	200mA					F <sub>low</sub>	R <sub>eflow</sub>	
	0.85		BLM21BD421SN1	420ohm±25%	-	200mA		Kit			F <sub>low</sub>	R <sub>eflow</sub>	
	0.85		BLM21BD471SN1	470ohm±25%	-	200mA		Kit			F <sub>low</sub>	R <sub>eflow</sub>	
	0.85		BLM21BD601SN1	600ohm±25%	-	200mA		Kit			F <sub>low</sub>	R <sub>eflow</sub>	
	0.85		BLM21BD751SN1	750ohm±25%	-	200mA					F <sub>low</sub>	R <sub>eflow</sub>	
	0.85		BLM21BD102SN1	1000ohm±25%	-	200mA		Kit			F <sub>low</sub>	R <sub>eflow</sub>	
	0.85		BLM21BD152SN1	1500ohm±25%	-	200mA		Kit			F <sub>low</sub>	R <sub>eflow</sub>	
	0.85		BLM21BD182SN1	1800ohm±25%	-	200mA		Kit			F <sub>low</sub>	R <sub>eflow</sub>	
	0.85		BLM21BD222TN1	2200ohm±25%	-	200mA		Kit			F <sub>low</sub>	R <sub>eflow</sub>	
	1.25		BLM21BD222SN1	2250ohm(Typ.)	-	200mA		Kit				F <sub>low</sub>	R <sub>eflow</sub>
	1.25		BLM21BD272SN1	2700ohm±25%	-	200mA		Kit				F <sub>low</sub>	R <sub>eflow</sub>
	0.85		BLM21BB050SN1	5ohm±25%	-	1000mA		Kit				F <sub>low</sub>	R <sub>eflow</sub>
	0.85		BLM21BB600SN1	60ohm±25%	-	800mA		Kit				F <sub>low</sub>	R <sub>eflow</sub>
	0.85		BLM21BB750SN1	75ohm±25%	-	700mA		Kit				F <sub>low</sub>	R <sub>eflow</sub>
	0.85		BLM21BB121SN1	120ohm±25%	-	600mA		Kit				F <sub>low</sub>	R <sub>eflow</sub>
	0.85		BLM21BB151SN1	150ohm±25%	-	600mA						F <sub>low</sub>	R <sub>eflow</sub>
	0.85		BLM21BB201SN1	200ohm±25%	-	500mA						F <sub>low</sub>	R <sub>eflow</sub>
0.85	BLM21BB221SN1	220ohm±25%	-	500mA		Kit				F <sub>low</sub>	R <sub>eflow</sub>		
0.85	BLM21BB331SN1	330ohm±25%	-	400mA		Kit				F <sub>low</sub>	R <sub>eflow</sub>		
0.85	BLM21BB471SN1	470ohm±25%	-	400mA		Kit				F <sub>low</sub>	R <sub>eflow</sub>		
0.85	For Digital Interface Lines	p73 BLM21RK121SN1	120ohm±25%	-	200mA					F <sub>low</sub>	R <sub>eflow</sub>		
0.85		BLM21RK221SN1	220ohm±25%	-	200mA					F <sub>low</sub>	R <sub>eflow</sub>		
0.85		BLM21RK471SN1	470ohm±25%	-	200mA					F <sub>low</sub>	R <sub>eflow</sub>		
0.85		BLM21RK601SN1	600ohm±25%	-	200mA					F <sub>low</sub>	R <sub>eflow</sub>		
0.85		BLM21RK102SN1	1000ohm±25%	-	200mA					F <sub>low</sub>	R <sub>eflow</sub>		
0.85	For Power Lines	p66 BLM21PG220SN1	22ohm±25%	-	6000mA		Kit	$\geq 3A$		F <sub>low</sub>	R <sub>eflow</sub>		
0.85		BLM21PG300SN1	30ohm(Typ.)	-	4000mA		Kit	$\geq 3A$		F <sub>low</sub>	R <sub>eflow</sub>		
0.85		BLM21PG600SN1	60ohm±25%	-	3500mA		Kit	$\geq 3A$		F <sub>low</sub>	R <sub>eflow</sub>		
0.85		BLM21PG121SN1	120ohm±25%	-	3000mA		Kit	$\geq 3A$		F <sub>low</sub>	R <sub>eflow</sub>		
0.85		BLM21PG221SN1	220ohm±25%	-	2000mA		Kit	$\geq 1A$		F <sub>low</sub>	R <sub>eflow</sub>		
0.85		BLM21PG331SN1	330ohm±25%	-	1500mA		Kit	$\geq 1A$		F <sub>low</sub>	R <sub>eflow</sub>		
1.1	For Power Lines	p75 BLM31PG330SN1	33ohm±25%	-	6000mA		Kit	$\geq 3A$		F <sub>low</sub>	R <sub>eflow</sub>		
1.1		BLM31PG500SN1	50ohm(Typ.)	-	3500mA		Kit	$\geq 3A$		F <sub>low</sub>	R <sub>eflow</sub>		
1.1		BLM31PG121SN1	120ohm±25%	-	3500mA		Kit	$\geq 3A$		F <sub>low</sub>	R <sub>eflow</sub>		
1.1		BLM31PG391SN1	390ohm±25%	-	2000mA		Kit	$\geq 1A$		F <sub>low</sub>	R <sub>eflow</sub>		
1.1		BLM31PG601SN1	600ohm±25%	-	1500mA		Kit	$\geq 1A$		F <sub>low</sub>	R <sub>eflow</sub>		
1.6	For Power Lines	p77 BLM41PG600SN1	60ohm(Typ.)	-	6000mA		Kit	$\geq 3A$		F <sub>low</sub>	R <sub>eflow</sub>		
1.6		BLM41PG750SN1	75ohm(Typ.)	-	3500mA		Kit	$\geq 3A$		F <sub>low</sub>	R <sub>eflow</sub>		
1.6		BLM41PG181SN1	180ohm±25%	-	3500mA		Kit	$\geq 3A$		F <sub>low</sub>	R <sub>eflow</sub>		
1.6		BLM41PG471SN1	470ohm±25%	-	2000mA		Kit	$\geq 1A$		F <sub>low</sub>	R <sub>eflow</sub>		
1.6		BLM41PG102SN1	1000ohm±25%	-	1500mA		Kit	$\geq 1A$		F <sub>low</sub>	R <sub>eflow</sub>		
1210 (3225)	0.2	For Power Lines	p79 BLE32PN300SN1	30ohm±10ohm	-	10000mA	New	$\geq 10A$		F <sub>low</sub>	R <sub>eflow</sub>		
0804 (2010)	0.5	For General Signal Lines	p80 BLA2AAG121SN4	120ohm±25%	-	100mA					R <sub>eflow</sub>		
	0.5		BLA2AAG221SN4	220ohm±25%	-	50mA					R <sub>eflow</sub>		
	0.5		BLA2AAG601SN4	600ohm±25%	-	50mA					R <sub>eflow</sub>		
	0.5		BLA2AAG102SN4	1000ohm±25%	-	50mA					R <sub>eflow</sub>		
	0.5	For High Speed Signal Lines	p80 BLA2ABD750SN4	75ohm±25%	-	200mA					R <sub>eflow</sub>		
	0.5		BLA2ABD121SN4	120ohm±25%	-	200mA					R <sub>eflow</sub>		
	0.5		BLA2ABD221SN4	220ohm±25%	-	100mA					R <sub>eflow</sub>		
	0.5		BLA2ABD471SN4	470ohm±25%	-	100mA					R <sub>eflow</sub>		
	0.5		BLA2ABD601SN4	600ohm±25%	-	100mA					R <sub>eflow</sub>		
	0.5		BLA2ABD102SN4	1000ohm±25%	-	50mA					R <sub>eflow</sub>		
	0.5		BLA2ABB100SN4	10ohm±25%	-	200mA					R <sub>eflow</sub>		
	0.5		BLA2ABB220SN4	22ohm±25%	-	200mA					R <sub>eflow</sub>		
	0.5		BLA2ABB470SN4	47ohm±25%	-	200mA					R <sub>eflow</sub>		
	0.5		BLA2ABB121SN4	120ohm±25%	-	50mA					R <sub>eflow</sub>		
0.5	BLA2ABB221SN4	220ohm±25%	-	50mA					R <sub>eflow</sub>				

Continued on the following page.

△Note • Please read rating and △CAUTION (for storage, operating, rating, soldering, mounting and handling) in this catalog to prevent smoking and/or burning, etc.  
• This catalog has only typical specifications. Therefore, please approve our product specifications or transact the approval sheet for product specifications before ordering.



Size Code in inch (in mm)	Thickness (mm)	Type	Part Number	Impedance		Rated Current	New	Kit	$\geq 1A$ $\geq 3A$ $\geq 10A$	GHz	 	 
				at 100MHz/20°C	at 1GHz/20°C							
1206 (3216)	0.8	For General Signal Lines	BLA31AG300SN4	30ohm±25%	-	200mA						
	0.8		BLA31AG600SN4	60ohm±25%	-	200mA						
	0.8		BLA31AG121SN4	120ohm±25%	-	150mA						
	0.8		BLA31AG221SN4	220ohm±25%	-	150mA						
	0.8		BLA31AG601SN4	600ohm±25%	-	100mA						
	0.8		BLA31AG102SN4	1000ohm±25%	-	50mA						
	0.8	For High Speed Signal Lines	BLA31BD121SN4	120ohm±25%	-	150mA						
	0.8		BLA31BD221SN4	220ohm±25%	-	150mA						
	0.8		BLA31BD471SN4	470ohm±25%	-	100mA						
	0.8		BLA31BD601SN4	600ohm±25%	-	100mA						
0.8		BLA31BD102SN4	1000ohm±25%	-	50mA							

Chip Ferrite Bead

Chip EMIFIL®

Chip Common Mode Choke Coil

Block Type EMIFIL®

Microwave Absorber

△Note • Please read rating and △CAUTION (for storage, operating, rating, soldering, mounting and handling) in this catalog to prevent smoking and/or burning, etc.  
 • This catalog has only typical specifications. Therefore, please approve our product specifications or transact the approval sheet for product specifications before ordering.

# BLM02AX Series 01005/0402 (inch/mm)



High Spec Ferrite Bead ultra low DC resistance. For general signal lines.

Chip Ferrite Bead  
01005/0402 (inch/mm)

Chip EMIFIL®

Chip Common Mode Choke Coil

Block Type EMIFIL®

Microwave Absorber



### ■ Dimensions

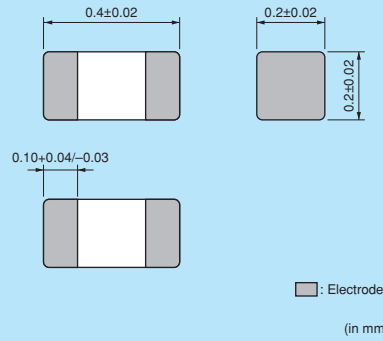

### ■ Equivalent Circuit

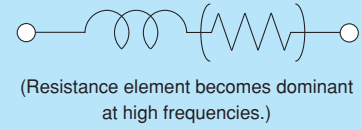

### ■ Packaging

Code	Packaging	Minimum Quantity
D	180mm Reel Paper Tape	20000
B	Bulk(Bag)	1000

Refer to pages from p.100 to p.103 for mounting information.

### ■ Rated Value (□: packaging code)

Part Number	Impedance (at 100MHz/20°C)	Rated Current	DC Resistance	Operating Temperature Range	
BLM02AX100SN1□	10ohm ±5 ohm	750mA	0.07ohm max.	-55°C to +125°C	Kit
BLM02AX700SN1□	70ohm ±25%	300mA	0.4ohm max.	-55°C to +125°C	Kit
BLM02AX121SN1□	120ohm ±25%	250mA	0.5ohm max.	-55°C to +125°C	Kit

Number of Circuits: 1

### ■ Impedance-Frequency Characteristics

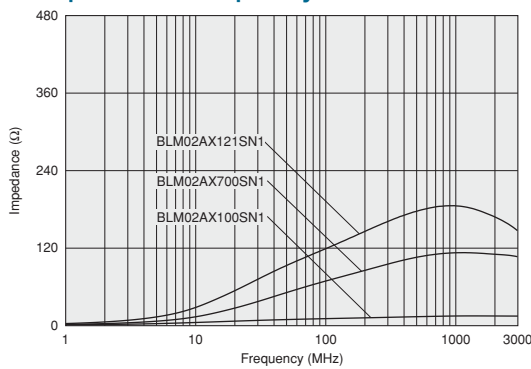

### ■ Impedance-Frequency Characteristics

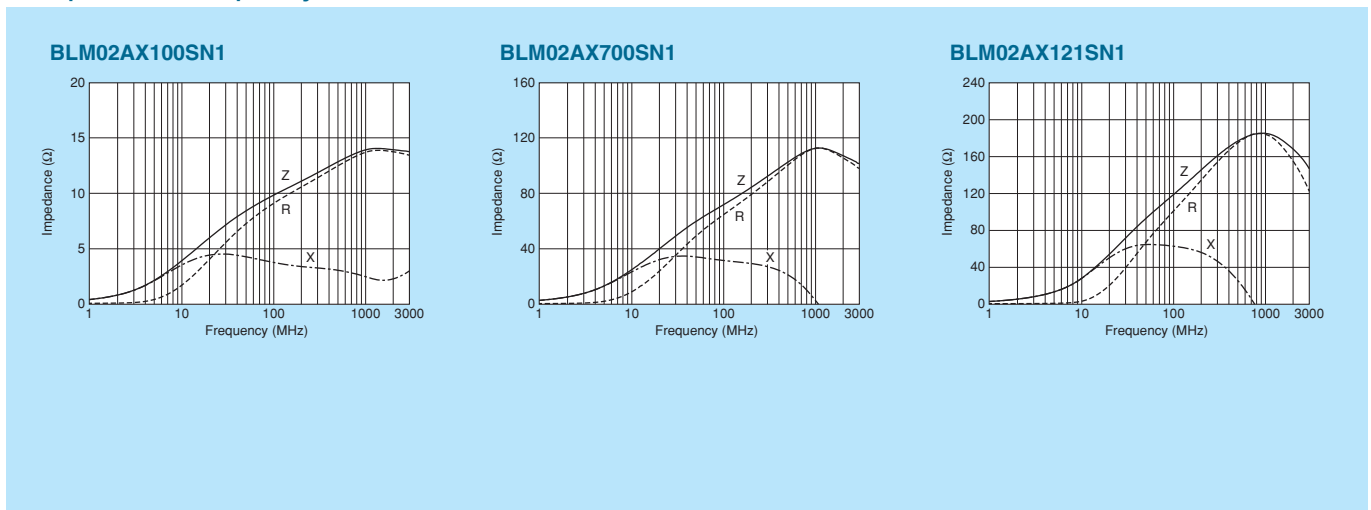

⚠Note • Please read rating and ⚠CAUTION (for storage, operating, rating, soldering, mounting and handling) in this catalog to prevent smoking and/or burning, etc.  
• This catalog has only typical specifications. Therefore, please approve our product specifications or transact the approval sheet for product specifications before ordering.

Excellent for Both Signal and Power Lines.  
Multi Function Chip Ferrite Bead BLM□□AX Series

Feature

- 1/2 the DC resistance than conventional type utilizing the latest technology
  - New ferrite material
  - Optimum ferrite firing condition
  - Fine piling technology
  - Advanced coil pattern design technology
- Improved stability of performance at heat shock
- Wide line-up from 10 to 1000ohm(@100MHz) useful for signal line

Advantage

- High Rated Current
  - Good for miniaturization of high power equipment
- Lower Voltage down at Ferrite bead
  - Good for Battery driven equipment by saving running voltage margin
- Higher Reliability

Drastically Reduced DC Resistance

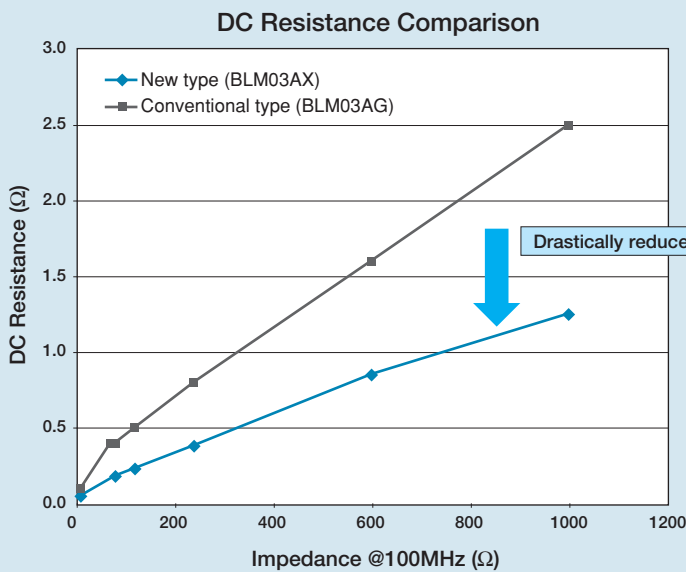

Test Result - Heat Shock

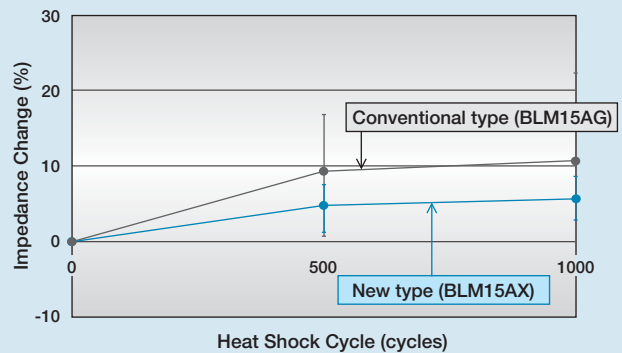

△Note • Please read rating and △CAUTION (for storage, operating, rating, soldering, mounting and handling) in this catalog to prevent smoking and/or burning, etc.  
• This catalog has only typical specifications. Therefore, please approve our product specifications or transact the approval sheet for product specifications before ordering.

# BLM02BX Series 01005/0402 (inch/mm)



High Spec Ferrite Bead ultra low DC resistance. For high speed signal lines.

Chip Ferrite Bead  
01005/0402 (inch/mm)

Chip EMIFIL®

Chip Common Mode Choke Coil

Block Type EMIFIL®

Microwave Absorber



### ■ Dimensions

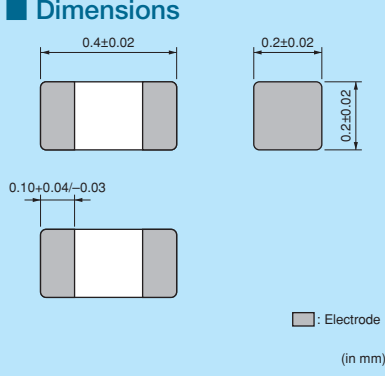

(in mm)

### ■ Equivalent Circuit



(Resistance element becomes dominant at high frequencies.)

### ■ Packaging

Code	Packaging	Minimum Quantity
D	180mm Reel Paper Tape	20000
B	Bulk(Bag)	1000

Refer to pages from p.100 to p.103 for mounting information.

### ■ Rated Value (□: packaging code)

Part Number	Impedance (at 100MHz/20°C)	Rated Current	DC Resistance	Operating Temperature Range	
BLM02BX151SN1□	150ohm ±25%	200mA	0.7ohm max.	-55°C to +125°C	<b>New</b>

Number of Circuits: 1

### ■ Impedance-Frequency Characteristics

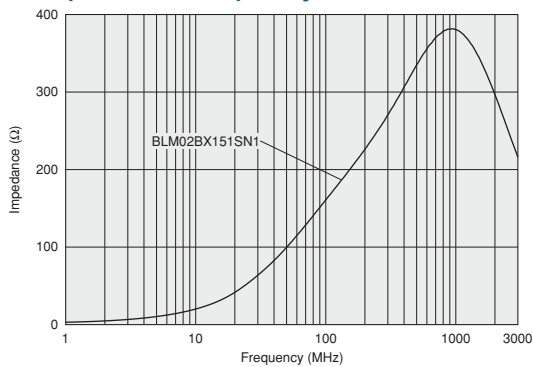

### ■ Impedance-Frequency Characteristics

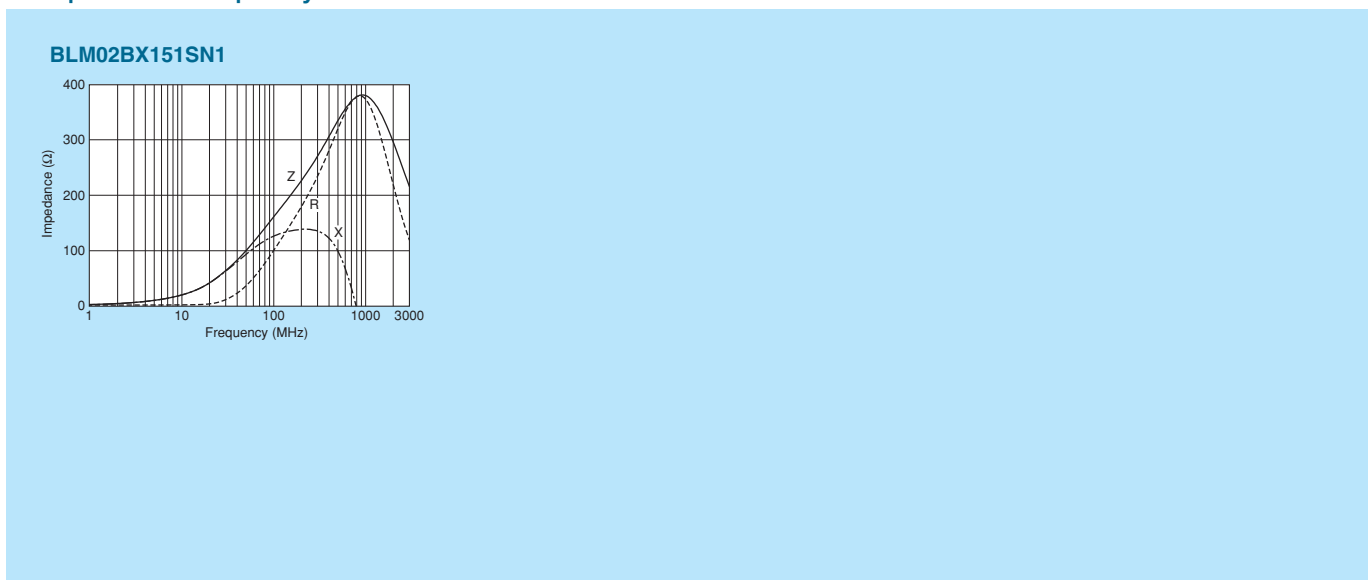

△Note • Please read rating and △CAUTION (for storage, operating, rating, soldering, mounting and handling) in this catalog to prevent smoking and/or burning, etc.  
• This catalog has only typical specifications. Therefore, please approve our product specifications or transact the approval sheet for product specifications before ordering.

# BLM03PG Series 0201/0603 (inch/mm)



## 0201 size for power lines.

\*Please refer to the products designed for both power lines and signal lines.



### ■ Dimensions

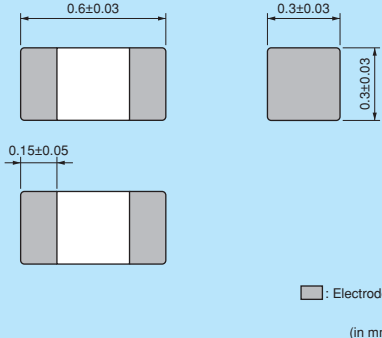

■: Electrode  
(in mm)

### ■ Equivalent Circuit



(Resistance element becomes dominant at high frequencies.)

### ■ Packaging

Code	Packaging	Minimum Quantity
D	180mm Reel Paper Tape	15000
J	330mm Reel Paper Tape	50000
B	Bulk(Bag)	1000

Refer to pages from p.100 to p.103 for mounting information.

### ■ Rated Value (□: packaging code)

Part Number	Impedance (at 100MHz/20°C)	Rated Current	DC Resistance	Operating Temperature Range	
BLM03PG220SN1□	22ohm ±25%	900mA	0.065ohm max.	-55°C to +125°C	Kit
BLM03PG330SN1□	33ohm ±25%	750mA	0.090ohm max.	-55°C to +125°C	Kit

Number of Circuits: 1

### ■ Impedance-Frequency Characteristics

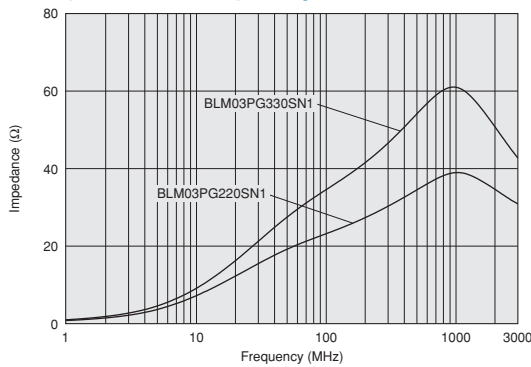

### ■ Impedance-Frequency Characteristics

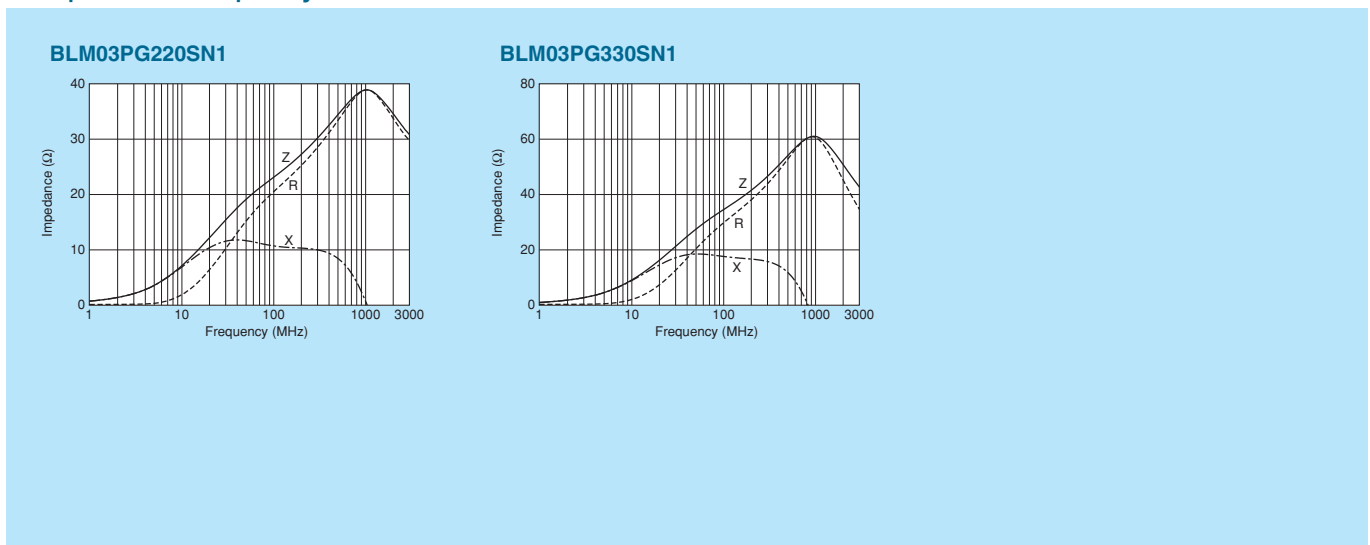

⚠Note • Please read rating and ⚠CAUTION (for storage, operating, rating, soldering, mounting and handling) in this catalog to prevent smoking and/or burning, etc.  
• This catalog has only typical specifications. Therefore, please approve our product specifications or transact the approval sheet for product specifications before ordering.

0201/0603 (inch/mm)  
Chip Ferrite Bead

Chip EMIFIL®

Chip Common Mode Choke Coil

Block Type EMIFIL®

Microwave Absorber

# BLM03PX Series 0201/0603 (inch/mm)



Improved DC resistance meets larger current.

Chip Ferrite Bead  
0201/0603 (inch/mm)



### ■ Dimensions

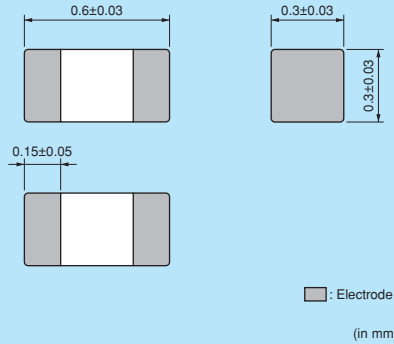

### ■ Equivalent Circuit

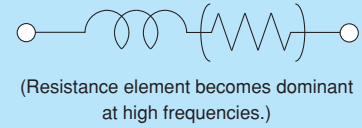

### ■ Packaging

Code	Packaging	Minimum Quantity
D	180mm Reel Paper Tape	15000
J	330mm Reel Paper Tape	50000
B	Bulk(Bag)	1000

Refer to pages from p.100 to p.103 for mounting information.

### ■ Rated Value (□: packaging code)

Part Number	Impedance (at 100MHz/20°C)	Rated Current	DC Resistance	Operating Temperature Range	
BLM03PX220SN1□	22ohm ±25%	1800mA	0.040ohm max.	-55°C to +125°C	Kit ≥1A
BLM03PX330SN1□	33ohm ±25%	1500mA	0.055ohm max.	-55°C to +125°C	Kit ≥1A
BLM03PX800SN1□	80ohm ±25%	1000mA	0.130ohm max.	-55°C to +125°C	Kit ≥1A

Number of Circuits: 1

### ■ Impedance-Frequency Characteristics

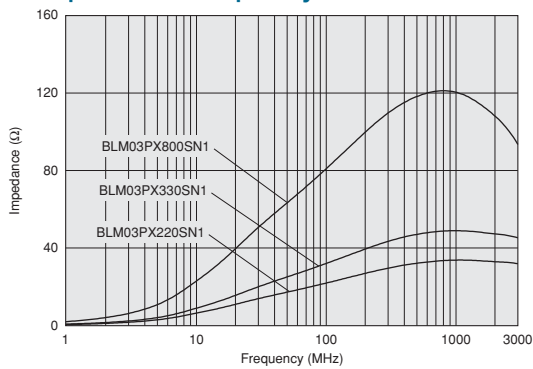

### ■ Notice (Rating)

In operating temperature exceeding +85°C derating of current is necessary for BLM03PX\_SN1 series. Please apply the derating curve shown in chart according to the operating temperature.

#### Derating of Rated Current

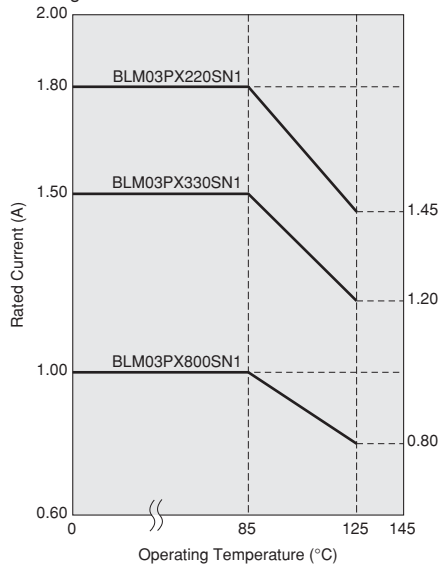

Continued on the following page.

△Note • Please read rating and △CAUTION (for storage, operating, rating, soldering, mounting and handling) in this catalog to prevent smoking and/or burning, etc.  
• This catalog has only typical specifications. Therefore, please approve our product specifications or transact the approval sheet for product specifications before ordering.

Chip EMIFIL®

Chip Common Mode Choke Coil

Block Type EMIFIL®

Microwave Absorber

Impedance-Frequency Characteristics

BLM03PX220SN1

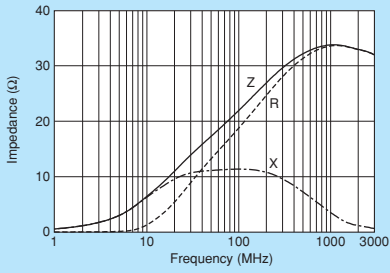

BLM03PX330SN1

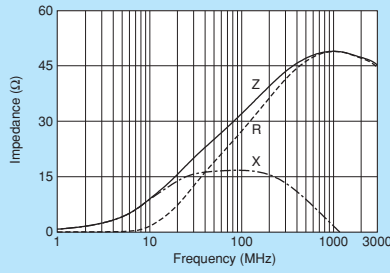

BLM03PX800SN1

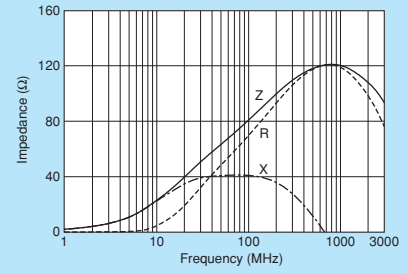

0201/0603 (inch/mm)  
 Chip Ferrite Bead

Chip EMIFIL®

Chip Common Mode Choke Coil

Block Type EMIFIL®

Microwave Absorber

⚠Note • Please read rating and ⚠CAUTION (for storage, operating, rating, soldering, mounting and handling) in this catalog to prevent smoking and/or burning, etc.  
 • This catalog has only typical specifications. Therefore, please approve our product specifications or transact the approval sheet for product specifications before ordering.

# BLM03AX Series 0201/0603 (inch/mm)



High Spec Ferrite Bead Ultra low DC resistance and wide impedance line up. Fit for both power lines and signal lines.

Chip Ferrite Bead 0201/0603 (inch/mm)

Chip EMIFIL®

Chip Common Mode Choke Coil

Block Type EMIFIL®

Microwave Absorber



### ■ Dimensions

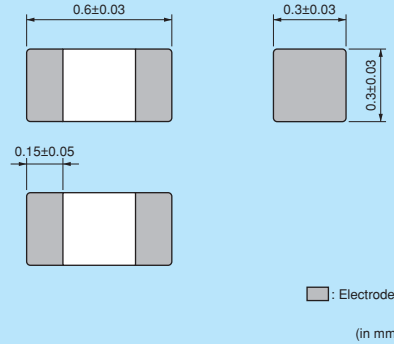

### ■ Equivalent Circuit

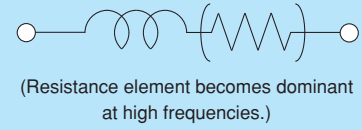

### ■ Packaging

Code	Packaging	Minimum Quantity
D	180mm Reel Paper Tape	15000
J	330mm Reel Paper Tape	50000
B	Bulk(Bag)	1000

Refer to pages from p.100 to p.103 for mounting information.

### ■ Rated Value (□: packaging code)

Part Number	Impedance (at 100MHz/20°C)	Rated Current	DC Resistance	Operating Temperature Range	
BLM03AX100SN1□	10ohm (Typ.)	1000mA	0.05ohm max.	-55°C to +125°C	Kit ≥1A
BLM03AX800SN1□	80ohm ±25%	500mA	0.18ohm max.	-55°C to +125°C	Kit
BLM03AX121SN1□	120ohm ±25%	450mA	0.23ohm max.	-55°C to +125°C	Kit
BLM03AX241SN1□	240ohm ±25%	350mA	0.38ohm max.	-55°C to +125°C	Kit
BLM03AX601SN1□	600ohm ±25%	250mA	0.85ohm max.	-55°C to +125°C	Kit
BLM03AX102SN1□	1000ohm ±25%	200mA	1.25ohm max.	-55°C to +125°C	Kit

Number of Circuits: 1

### ■ Impedance-Frequency Characteristics

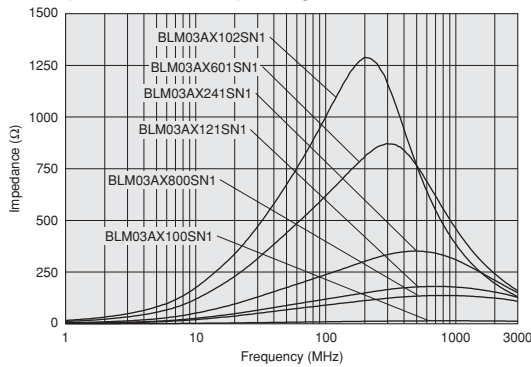

### ■ Impedance-Frequency Characteristics

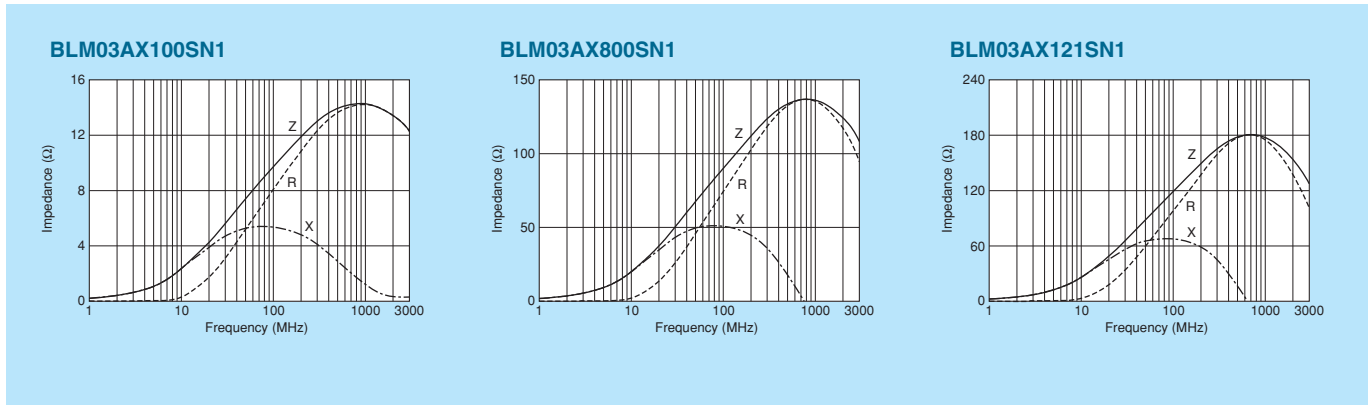

Continued on the following page.

△Note • Please read rating and △CAUTION (for storage, operating, rating, soldering, mounting and handling) in this catalog to prevent smoking and/or burning, etc.  
 • This catalog has only typical specifications. Therefore, please approve our product specifications or transact the approval sheet for product specifications before ordering.



Impedance-Frequency Characteristics

BLM03AX241SN1

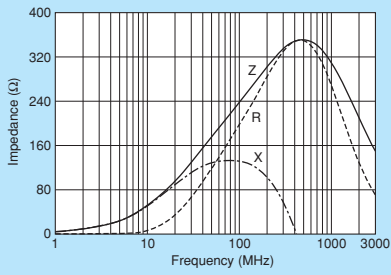

BLM03AX601SN1

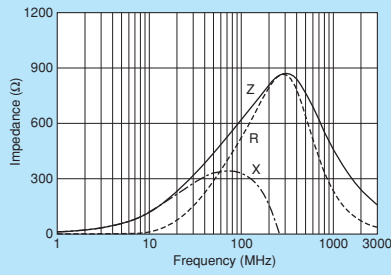

BLM03AX102SN1

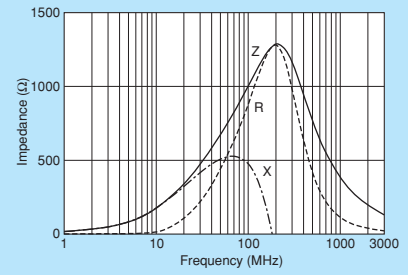

0201/0603 (inch/mm)  
Chip Ferrite Bead

Chip EMIFIL®

Chip Common Mode Choke Coil

Block Type EMIFIL®

Microwave Absorber

⚠Note • Please read rating and ⚠CAUTION (for storage, operating, rating, soldering, mounting and handling) in this catalog to prevent smoking and/or burning, etc.  
 • This catalog has only typical specifications. Therefore, please approve our product specifications or transact the approval sheet for product specifications before ordering.

# BLM03AG Series 0201/0603 (inch/mm)



0201 size for general signal lines.

Chip Ferrite Bead  
0201/0603 (inch/mm)

Chip EMIFIL®

Chip Common Mode Choke Coil

Block Type EMIFIL®

Microwave Absorber



### ■ Dimensions

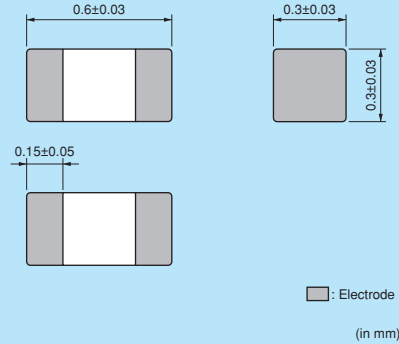

### ■ Equivalent Circuit

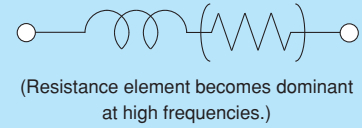

### ■ Packaging

Code	Packaging	Minimum Quantity
D	180mm Reel Paper Tape	15000
J	330mm Reel Paper Tape	50000
B	Bulk(Bag)	1000

Refer to pages from p.100 to p.103 for mounting information.

### ■ Rated Value (□: packaging code)

Part Number	Impedance (at 100MHz/20°C)	Rated Current	DC Resistance	Operating Temperature Range	
BLM03AG100SN1□	10ohm (Typ.)	500mA	0.1ohm max.	-55°C to +125°C	Kit
BLM03AG700SN1□	70ohm (Typ.)	200mA	0.4ohm max.	-55°C to +125°C	Kit
BLM03AG800SN1□	80ohm ±25%	200mA	0.4ohm max.	-55°C to +125°C	Kit
BLM03AG121SN1□	120ohm ±25%	200mA	0.5ohm max.	-55°C to +125°C	Kit
BLM03AG241SN1□	240ohm ±25%	200mA	0.8ohm max.	-55°C to +125°C	Kit
BLM03AG601SN1□	600ohm ±25%	100mA	1.5ohm max.	-55°C to +125°C	Kit
BLM03AG102SN1□	1000ohm ±25%	100mA	2.5ohm max.	-55°C to +125°C	Kit

Number of Circuits: 1

### ■ Impedance-Frequency Characteristics

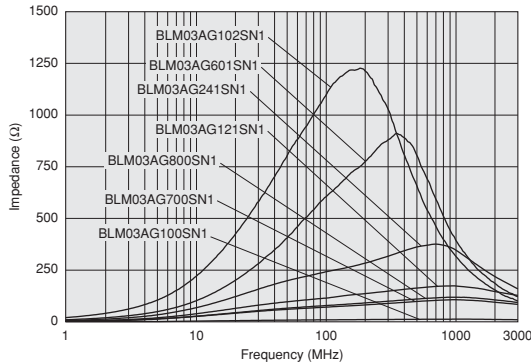

### ■ Impedance-Frequency Characteristics

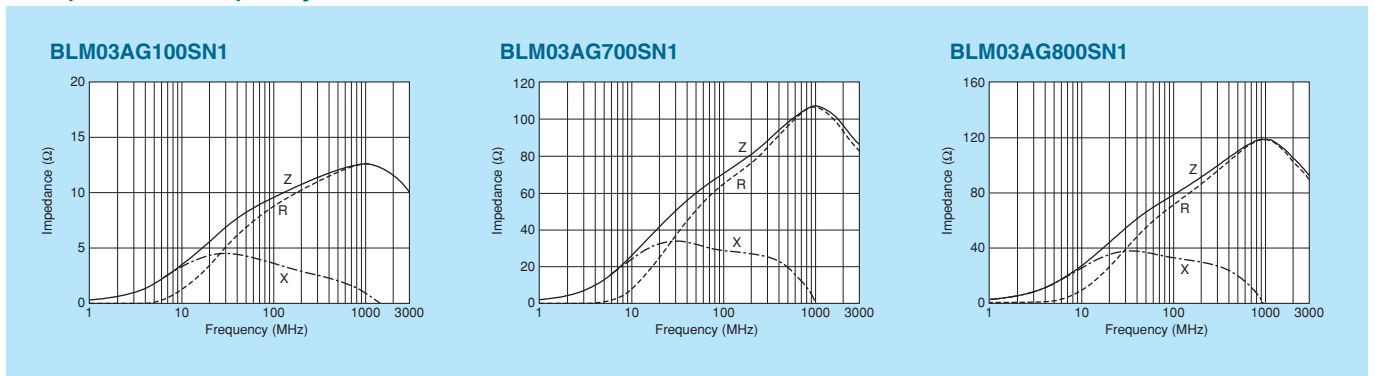

Continued on the following page.

⚠Note • Please read rating and ⚠CAUTION (for storage, operating, rating, soldering, mounting and handling) in this catalog to prevent smoking and/or burning, etc.  
• This catalog has only typical specifications. Therefore, please approve our product specifications or transact the approval sheet for product specifications before ordering.

Impedance-Frequency Characteristics

BLM03AG121SN1

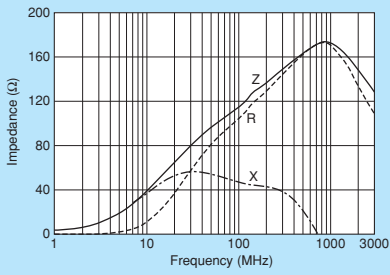

BLM03AG241SN1

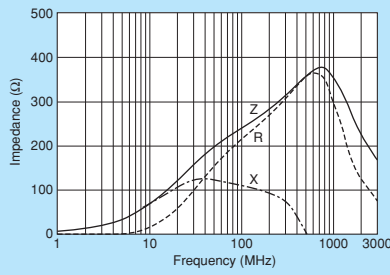

BLM03AG601SN1

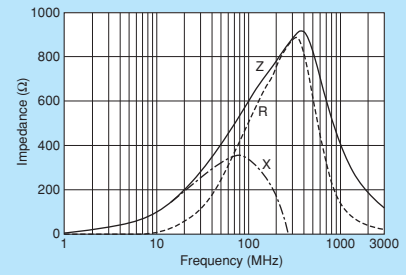

BLM03AG102SN1

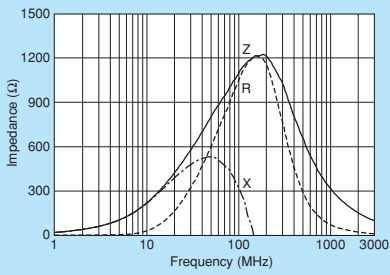

0201/0603 (inch/mm)  
Chip Ferrite Bead

Chip EMIFIL®

Chip Common Mode Choke Coil

Block Type EMIFIL®

Microwave Absorber

⚠Note • Please read rating and ⚠CAUTION (for storage, operating, rating, soldering, mounting and handling) in this catalog to prevent smoking and/or burning, etc.  
 • This catalog has only typical specifications. Therefore, please approve our product specifications or transact the approval sheet for product specifications before ordering.

# BLM03B Series 0201/0603 (inch/mm)



0201 size for high speed signal lines.

Chip Ferrite Bead  
0201/0603 (inch/mm)

Chip EMIFIL®

Chip Common Mode Choke Coil

Block Type EMIFIL®

Microwave Absorber



### ■ Dimensions

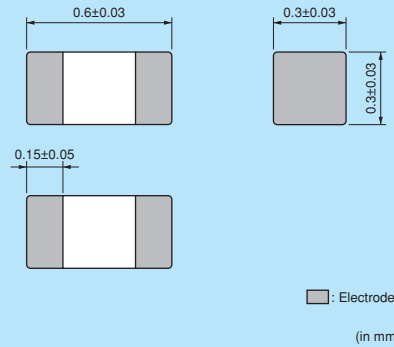

### ■ Equivalent Circuit

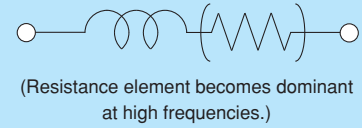

### ■ Packaging

Code	Packaging	Minimum Quantity
D	180mm Reel Paper Tape	15000
J	330mm Reel Paper Tape	50000
B	Bulk(Bag)	1000

Refer to pages from p.100 to p.103 for mounting information.

### ■ Rated Value (□: packaging code)

Part Number	Impedance (at 100MHz/20°C)	Rated Current	DC Resistance	Operating Temperature Range	
BLM03BD750SN1□	75ohm ±25%	300mA	0.4ohm max.	-55°C to +125°C	Kit
BLM03BD121SN1□	120ohm ±25%	250mA	0.5ohm max.	-55°C to +125°C	Kit
BLM03BD241SN1□	240ohm ±25%	200mA	0.8ohm max.	-55°C to +125°C	Kit
BLM03BD471SN1□	470ohm ±25%	215mA	1.5ohm max.	-55°C to +125°C	Kit
BLM03BD601SN1□	600ohm ±25%	200mA	1.7ohm max.	-55°C to +125°C	Kit
BLM03BB100SN1□	10ohm ±25%	300mA	0.4ohm max.	-55°C to +125°C	Kit
BLM03BB220SN1□	22ohm ±25%	200mA	0.5ohm max.	-55°C to +125°C	Kit
BLM03BB470SN1□	47ohm ±25%	200mA	0.7ohm max.	-55°C to +125°C	Kit
BLM03BB750SN1□	75ohm ±25%	200mA	1.0ohm max.	-55°C to +125°C	Kit
BLM03BB121SN1□	120ohm ±25%	100mA	1.5ohm max.	-55°C to +125°C	Kit
BLM03BC330SN1□	33ohm ±25%	150mA	0.85ohm max.	-55°C to +125°C	Kit
BLM03BC560SN1□	56ohm ±25%	100mA	1.05ohm max.	-55°C to +125°C	Kit
BLM03BC800SN1□	80ohm ±25%	100mA	1.40ohm max.	-55°C to +125°C	Kit

Number of Circuits: 1

### ■ Impedance-Frequency Characteristics

#### BLM03BD Series

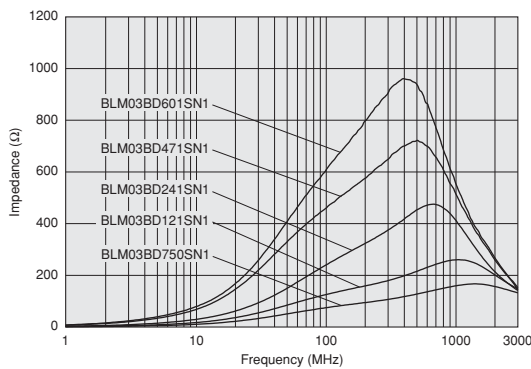

#### BLM03BB Series

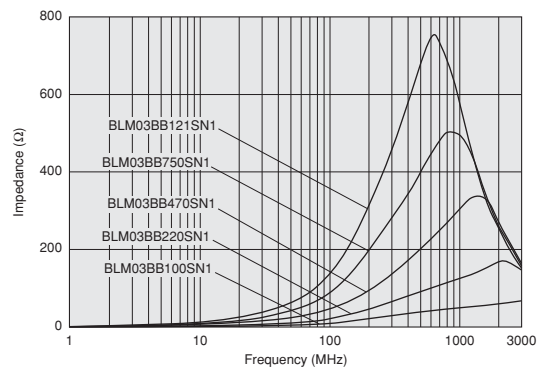

Continued on the following page. ↗

△Note • Please read rating and △CAUTION (for storage, operating, rating, soldering, mounting and handling) in this catalog to prevent smoking and/or burning, etc.  
• This catalog has only typical specifications. Therefore, please approve our product specifications or transact the approval sheet for product specifications before ordering.

Impedance-Frequency Characteristics  
 BLM03BC Series

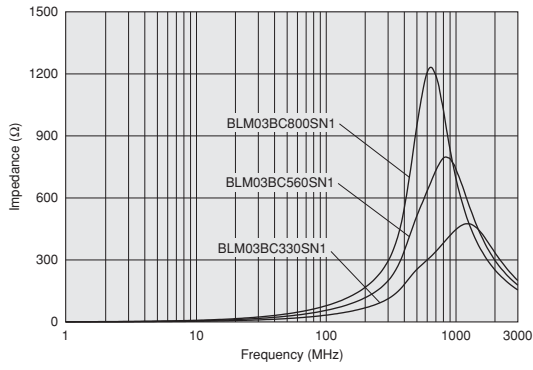

Impedance-Frequency Characteristics

BLM03BD750SN1

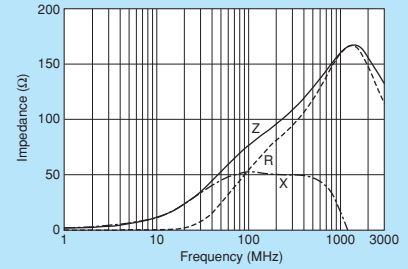

BLM03BD121SN1

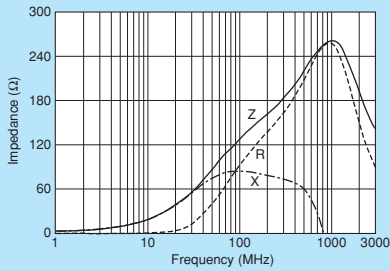

BLM03BD241SN1

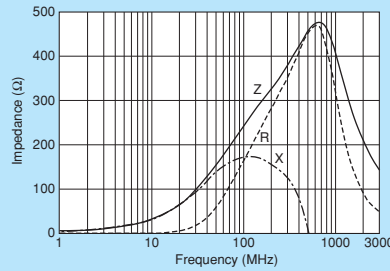

BLM03BD471SN1

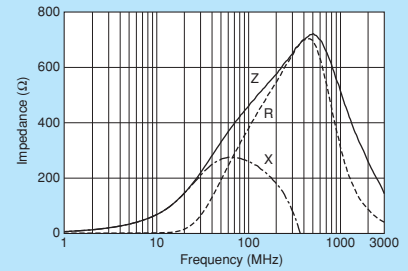

BLM03BD601SN1

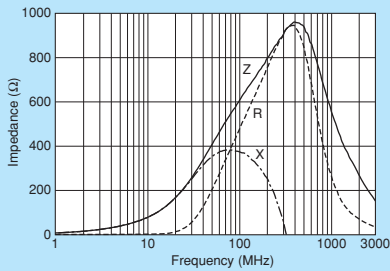

BLM03BB100SN1

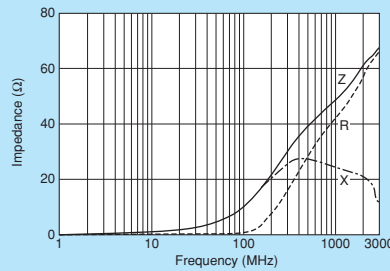

BLM03BB220SN1

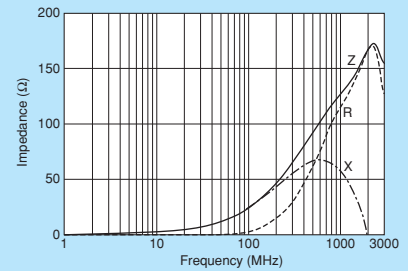

BLM03BB470SN1

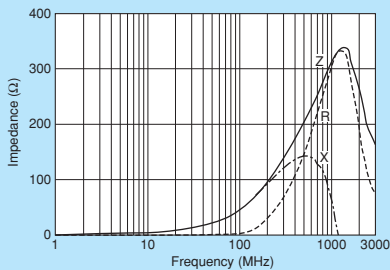

BLM03BB750SN1

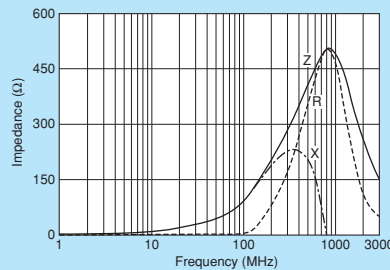

BLM03BB121SN1

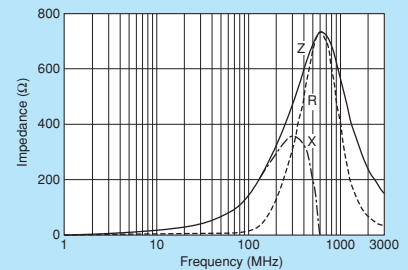

BLM03BC330SN1

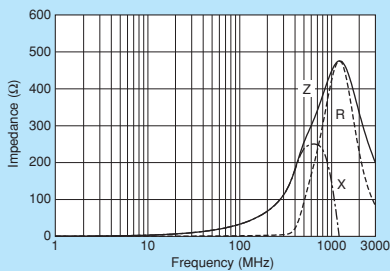

BLM03BC560SN1

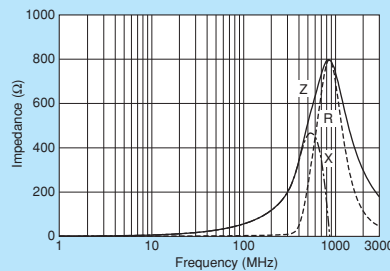

BLM03BC800SN1

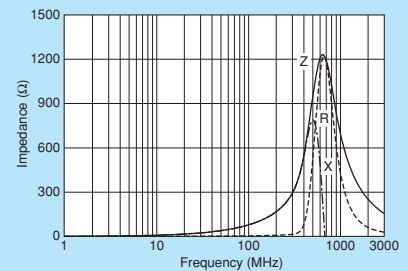

Note • Please read rating and CAUTION (for storage, operating, rating, soldering, mounting and handling) in this catalog to prevent smoking and/or burning, etc.  
 • This catalog has only typical specifications. Therefore, please approve our product specifications or transact the approval sheet for product specifications before ordering.

# BLM15PX Series 0402/1005 (inch/mm)



3A max., high performance type for power lines up to 600ohm.

Chip Ferrite Bead  
0402/1005 (inch/mm)

Chip EMIFIL®

Chip Common Mode Choke Coil

Block Type EMIFIL®

Microwave Absorber



### ■ Dimensions

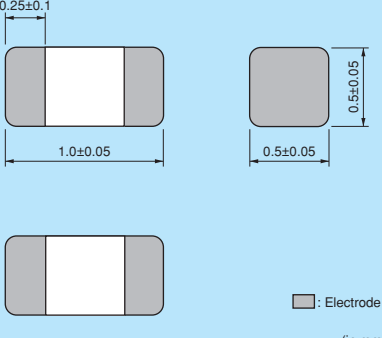

(in mm)

### ■ Equivalent Circuit



(Resistance element becomes dominant at high frequencies.)

### ■ Packaging

Code	Packaging	Minimum Quantity
D	180mm Reel Paper Tape	10000
J	330mm Reel Paper Tape	50000
B	Bulk(Bag)	1000

Refer to pages from p.100 to p.103 for mounting information.

### ■ Rated Value (□: packaging code)

Part Number	Impedance (at 100MHz/20°C)	Rated Current	DC Resistance	Operating Temperature Range	Kit	Current
BLM15PX330SN1□	33ohm ±25%	3000mA	0.022ohm max.	-55°C to +125°C	Kit	≥3A
BLM15PX600SN1□	60ohm ±25%	2500mA	0.032ohm max.	-55°C to +125°C	Kit	≥1A
BLM15PX800SN1□	80ohm ±25%	2300mA	0.038ohm max.	-55°C to +125°C	Kit	≥1A
BLM15PX121SN1□	120ohm ±25%	2000mA	0.055ohm max.	-55°C to +125°C	Kit	≥1A
BLM15PX181SN1□	180ohm ±25%	1500mA	0.090ohm max.	-55°C to +125°C	Kit	≥1A
BLM15PX221SN1□	220ohm ±25%	1400mA	0.10ohm max.	-55°C to +125°C	Kit	≥1A
BLM15PX331SN1□	330ohm ±25%	1200mA	0.15ohm max.	-55°C to +125°C	Kit	≥1A
BLM15PX471SN1□	470ohm ±25%	1000mA	0.20ohm max.	-55°C to +125°C	Kit	≥1A
BLM15PX601SN1□	600ohm ±25%	900mA	0.23ohm max.	-55°C to +125°C	Kit	

Number of Circuits: 1

### ■ Impedance-Frequency Characteristics

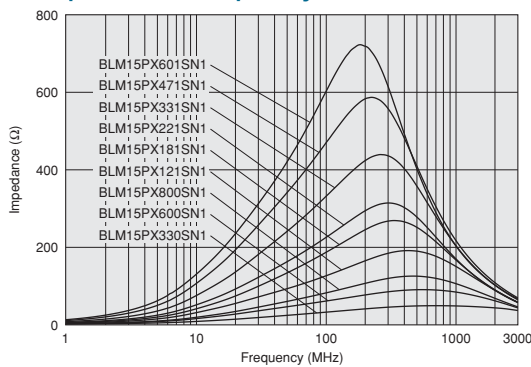

### ■ Notice (Rating)

In operating temperature exceeding +85°C, derating of current is necessary for BLM15PX series.

Please apply the derating curve shown in chart according to the operating temperature.

Derating of Rated Current

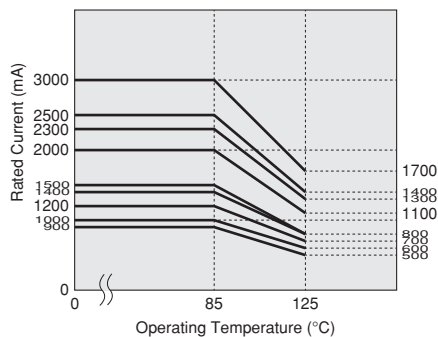

Continued on the following page. ↗

△Note • Please read rating and △CAUTION (for storage, operating, rating, soldering, mounting and handling) in this catalog to prevent smoking and/or burning, etc.  
• This catalog has only typical specifications. Therefore, please approve our product specifications or transact the approval sheet for product specifications before ordering.

Impedance-Frequency Characteristics

BLM15PX330SN1

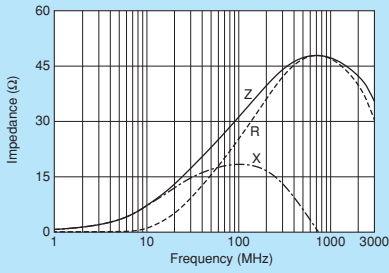

BLM15PX600SN1

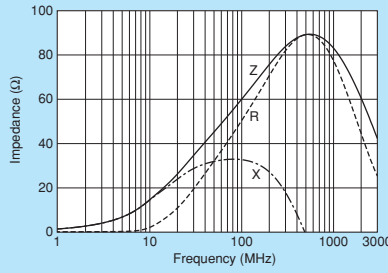

BLM15PX800SN1

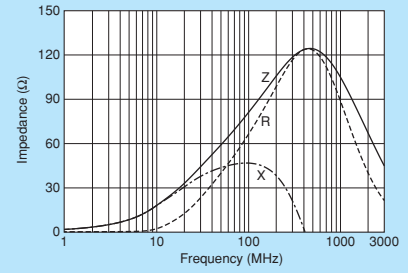

BLM15PX121SN1

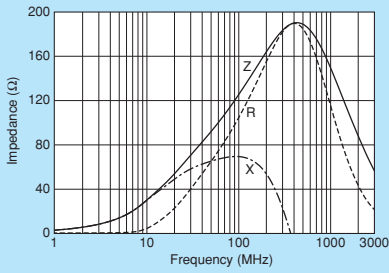

BLM15PX181SN1

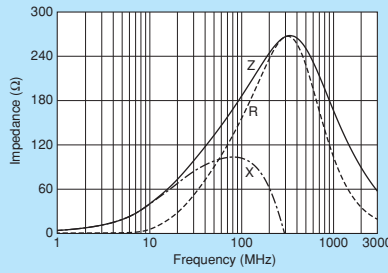

BLM15PX221SN1

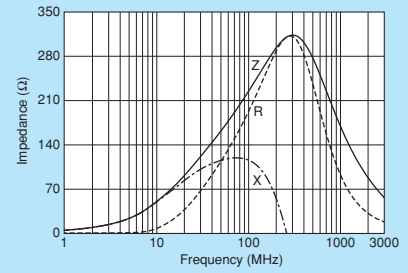

BLM15PX331SN1

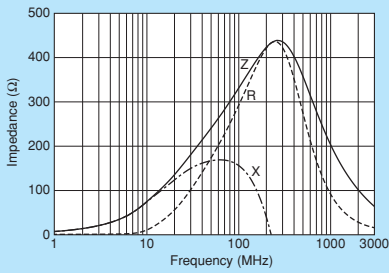

BLM15PX471SN1

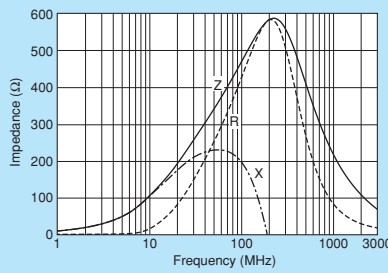

BLM15PX601SN1

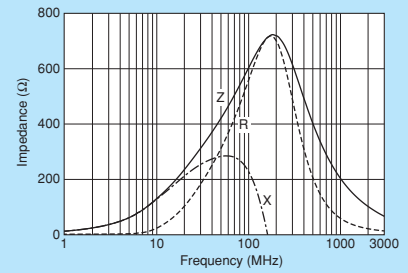

0402/1005 (inch/mm)  
 Chip Ferrite Bead

Chip EMIFIL®

Chip Common Mode Choke Coil

Block Type EMIFIL®

Microwave Absorber

⚠Note • Please read rating and ⚠CAUTION (for storage, operating, rating, soldering, mounting and handling) in this catalog to prevent smoking and/or burning, etc.  
 • This catalog has only typical specifications. Therefore, please approve our product specifications or transact the approval sheet for product specifications before ordering.

# BLM15PG/BLM15PD Series 0402/1005 (inch/mm)



## 0402 size for power lines.

\*Please refer to the products which are designed for both power lines and signal lines.

Chip Ferrite Bead  
0402/1005 (inch/mm)

Chip EMIFIL®

Chip Common Mode Choke Coil

Block Type EMIFIL®

Microwave Absorber

### ■ Dimensions

(in mm)

■ : Electrode

### ■ Equivalent Circuit

(Resistance element becomes dominant at high frequencies.)

### ■ Packaging

Code	Packaging	Minimum Quantity
D	180mm Reel Paper Tape	10000
J	330mm Reel Paper Tape	50000
B	Bulk(Bag)	1000

Refer to pages from p.100 to p.103 for mounting information.

### ■ Rated Value (□: packaging code)

Part Number	Impedance (at 100MHz/20°C)	Rated Current	DC Resistance	Operating Temperature Range	
BLM15PG100SN1□	10ohm (Typ.)	1000mA	0.025ohm max.	-55°C to +125°C	Kit ≥1A
BLM15PD300SN1□	30ohm ±25%	2200mA	0.035ohm max.	-55°C to +125°C	Kit ≥1A
BLM15PD600SN1□	60ohm ±25%	1700mA	0.06ohm max.	-55°C to +125°C	Kit ≥1A
BLM15PD800SN1□	80ohm ±25%	1500mA	0.07ohm max.	-55°C to +125°C	Kit ≥1A
BLM15PD121SN1□	120ohm ±25%	1300mA	0.09ohm max.	-55°C to +125°C	Kit ≥1A

Number of Circuits: 1

### ■ Impedance-Frequency Characteristics

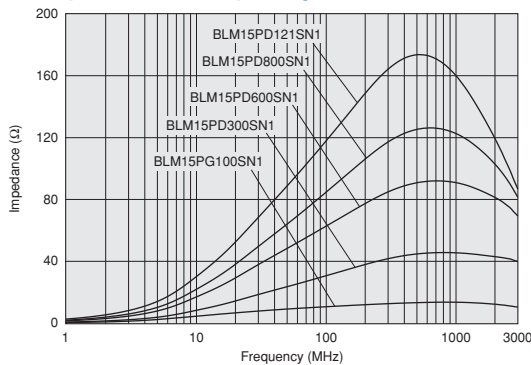

### ■ Notice (Rating)

In operating temperature exceeding +85°C, derating of current is necessary for BLM15PD series.

Please apply the derating curve shown in chart according to the operating temperature.

Derating of Rated Current

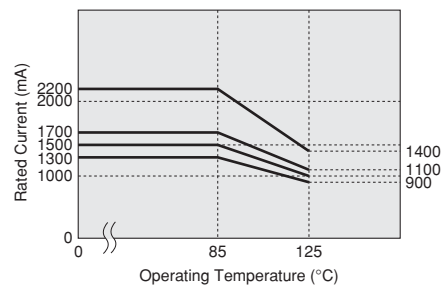

Continued on the following page.

⚠Note • Please read rating and ⚠CAUTION (for storage, operating, rating, soldering, mounting and handling) in this catalog to prevent smoking and/or burning, etc.  
• This catalog has only typical specifications. Therefore, please approve our product specifications or transact the approval sheet for product specifications before ordering.



Impedance-Frequency Characteristics

BLM15PG100SN1

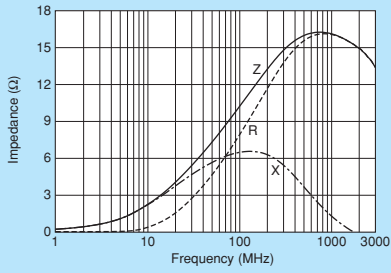

BLM15PD300SN1

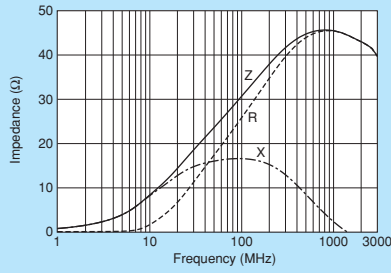

BLM15PD600SN1

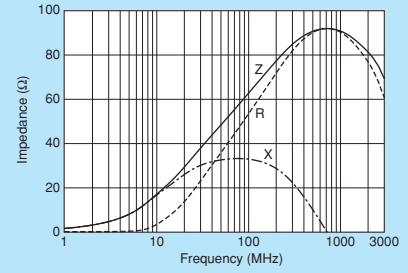

BLM15PD800SN1

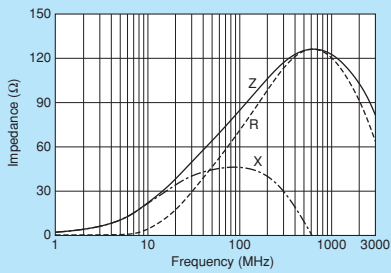

BLM15PD121SN1

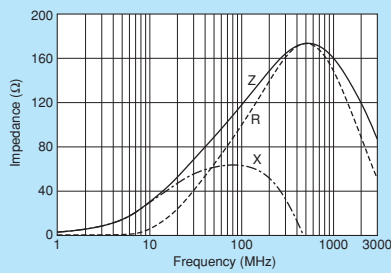

0402/1005 (inch/mm)  
 Chip Ferrite Bead

Chip EMIFIL®

Chip Common Mode Choke Coil

Block Type EMIFIL®

Microwave Absorber

⚠Note • Please read rating and ⚠CAUTION (for storage, operating, rating, soldering, mounting and handling) in this catalog to prevent smoking and/or burning, etc.  
 • This catalog has only typical specifications. Therefore, please approve our product specifications or transact the approval sheet for product specifications before ordering.

# BLM15AX Series 0402/1005 (inch/mm)



High Spec Ferrite Bead Ultra low DC resistance and wide impedance line up. Fit for both power lines and signal lines.

Chip Ferrite Bead 0402/1005 (inch/mm)

Chip EMIFIL®

Chip Common Mode Choke Coil

Block Type EMIFIL®

Microwave Absorber

### ■ Dimensions

(in mm)

### ■ Equivalent Circuit

(Resistance element becomes dominant at high frequencies.)

### ■ Packaging

Code	Packaging	Minimum Quantity
D	180mm Reel Paper Tape	10000
J	330mm Reel Paper Tape	50000
B	Bulk(Bag)	1000

Refer to pages from p.100 to p.103 for mounting information.

### ■ Rated Value (□: packaging code)

Part Number	Impedance (at 100MHz/20°C)	Rated Current	DC Resistance	Operating Temperature Range	
BLM15AX100SN1□	10ohm ±5ohm	1740mA	0.015ohm max.	-55°C to +125°C	Kit ≥1A
BLM15AX300SN1□	30ohm ±25%	1100mA	0.06ohm max.	-55°C to +125°C	Kit ≥1A
BLM15AX700SN1□	70ohm ±25%	780mA	0.1ohm max.	-55°C to +125°C	Kit
BLM15AX121SN1□	120ohm ±25%	700mA	0.13ohm max.	-55°C to +125°C	Kit
BLM15AX221SN1□	220ohm ±25%	600mA	0.18ohm max.	-55°C to +125°C	Kit
BLM15AX601SN1□	600ohm ±25%	500mA	0.34ohm max.	-55°C to +125°C	Kit
BLM15AX102SN1□	1000ohm ±25%	350mA	0.49ohm max.	-55°C to +125°C	Kit

Number of Circuits: 1

### ■ Impedance-Frequency Characteristics

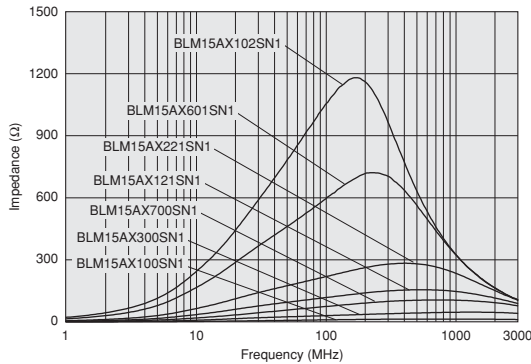

Continued on the following page. ↗

△Note • Please read rating and △CAUTION (for storage, operating, rating, soldering, mounting and handling) in this catalog to prevent smoking and/or burning, etc.  
 • This catalog has only typical specifications. Therefore, please approve our product specifications or transact the approval sheet for product specifications before ordering.

Impedance-Frequency Characteristics

BLM15AX100SN1

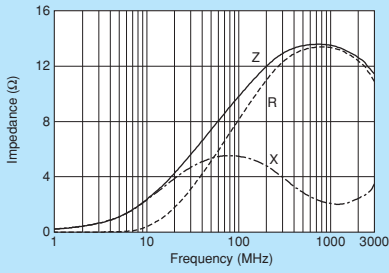

BLM15AX300SN1

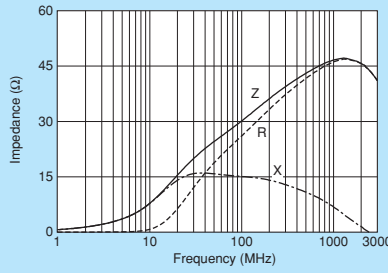

BLM15AX700SN1

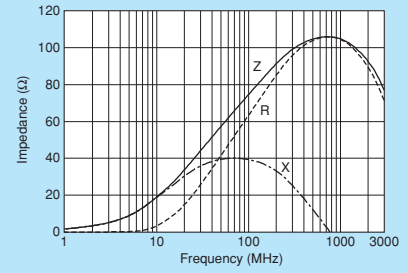

BLM15AX121SN1

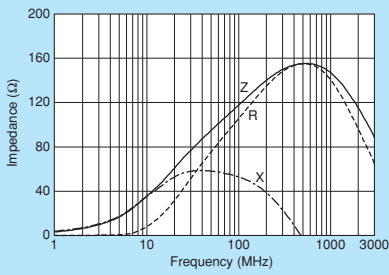

BLM15AX221SN1

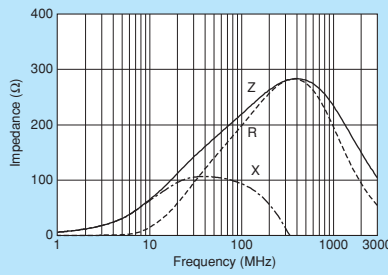

BLM15AX601SN1

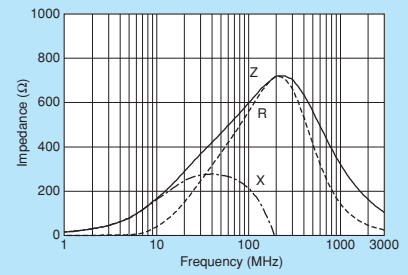

BLM15AX102SN1

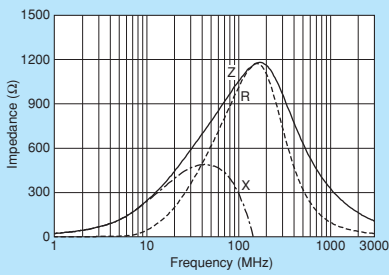

0402/1005 (inch/mm)  
Chip Ferrite Bead

Chip EMIFIL®

Chip Common Mode Choke Coil

Block Type EMIFIL®

Microwave Absorber

⚠Note • Please read rating and ⚠CAUTION (for storage, operating, rating, soldering, mounting and handling) in this catalog to prevent smoking and/or burning, etc.  
 • This catalog has only typical specifications. Therefore, please approve our product specifications or transact the approval sheet for product specifications before ordering.

# BLM15AG Series 0402/1005 (inch/mm)



0402 size for general signal lines.

Chip Ferrite Bead  
0402/1005 (inch/mm)

Chip EMIFIL®

Chip Common Mode Choke Coil

Block Type EMIFIL®

Microwave Absorber



### ■ Dimensions

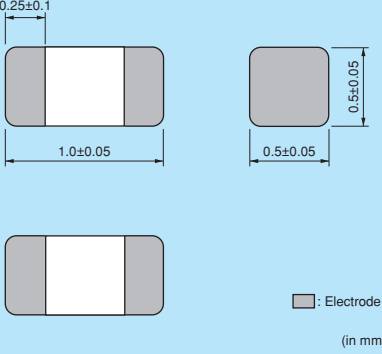

(in mm)

### ■ Equivalent Circuit



(Resistance element becomes dominant at high frequencies.)

### ■ Packaging

Code	Packaging	Minimum Quantity
D	180mm Reel Paper Tape	10000
J	330mm Reel Paper Tape	50000
B	Bulk(Bag)	1000

Refer to pages from p.100 to p.103 for mounting information.

## ■ Rated Value (□: packaging code)

Part Number	Impedance (at 100MHz/20°C)	Rated Current	DC Resistance	Operating Temperature Range	
BLM15AG100SN1□	10ohm (Typ.)	1000mA	0.025ohm max.	-55°C to +125°C	Kit ≥1A
BLM15AG700SN1□	70ohm (Typ.)	600mA	0.15ohm max.	-55°C to +125°C	Kit
BLM15AG121SN1□	120ohm ±25%	550mA	0.19ohm max.	-55°C to +125°C	Kit
BLM15AG221SN1□	220ohm ±25%	450mA	0.29ohm max.	-55°C to +125°C	Kit
BLM15AG601SN1□	600ohm ±25%	300mA	0.52ohm max.	-55°C to +125°C	Kit
BLM15AG102SN1□	1000ohm ±25%	300mA	0.65ohm max.	-55°C to +125°C	Kit

Number of Circuits: 1

## ■ Impedance-Frequency Characteristics

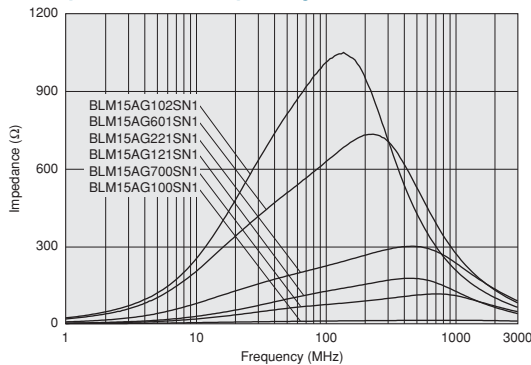

## ■ Impedance-Frequency Characteristics

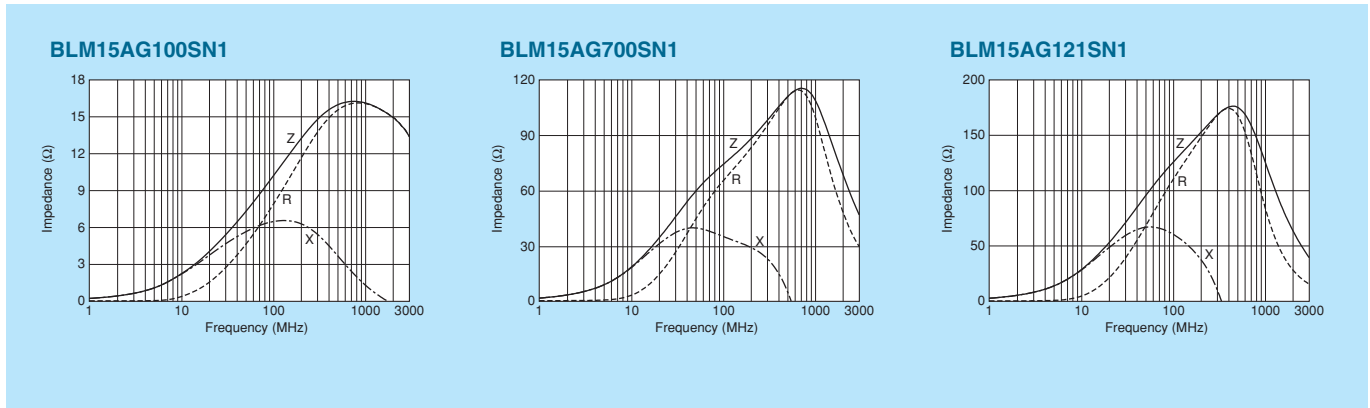

Continued on the following page.

△Note • Please read rating and △CAUTION (for storage, operating, rating, soldering, mounting and handling) in this catalog to prevent smoking and/or burning, etc.  
• This catalog has only typical specifications. Therefore, please approve our product specifications or transact the approval sheet for product specifications before ordering.

Impedance-Frequency Characteristics

BLM15AG221SN1

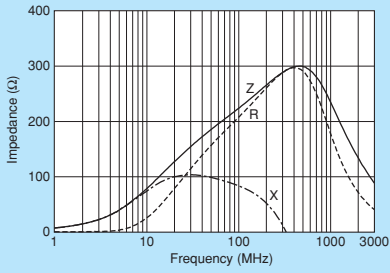

BLM15AG601SN1

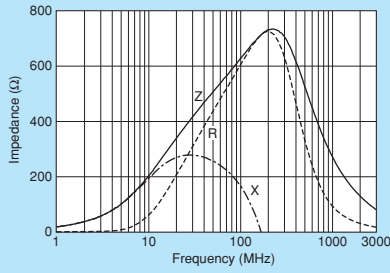

BLM15AG102SN1

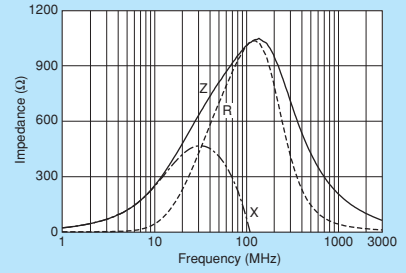

0402/1005 (inch/mm)  
Chip Ferrite Bead

Chip EMIFIL®

Chip Common Mode Choke Coil

Block Type EMIFIL®

Microwave Absorber

⚠Note • Please read rating and ⚠CAUTION (for storage, operating, rating, soldering, mounting and handling) in this catalog to prevent smoking and/or burning, etc.  
 • This catalog has only typical specifications. Therefore, please approve our product specifications or transact the approval sheet for product specifications before ordering.

# BLM15BX Series 0402/1005 (inch/mm)



0402 size for high speed signal lines, low DC resistance.

Chip Ferrite Bead  
0402/1005 (inch/mm)

Chip EMIFIL®

Chip Common Mode Choke Coil

Block Type EMIFIL®

Microwave Absorber

### ■ Dimensions

0.25±0.1  
1.0±0.05  
0.5±0.05  
0.5±0.05  
■: Electrode  
(in mm)

### ■ Equivalent Circuit

(Resistance element becomes dominant at high frequencies.)

### ■ Packaging

Code	Packaging	Minimum Quantity
D	180mm Reel Paper Tape	10000
J	330mm Reel Paper Tape	50000
B	Bulk(Bag)	1000

Refer to pages from p.100 to p.103 for mounting information.

### ■ Rated Value (□: packaging code)

Part Number	Impedance (at 100MHz/20°C)	Rated Current	DC Resistance	Operating Temperature Range	
BLM15BX750SN1□	75ohm ±25%	600mA	0.15ohm max.	-55°C to +125°C	Kit
BLM15BX121SN1□	120ohm ±25%	600mA	0.17ohm max.	-55°C to +125°C	Kit
BLM15BX221SN1□	220ohm ±25%	450mA	0.27ohm max.	-55°C to +125°C	Kit
BLM15BX471SN1□	470ohm ±25%	350mA	0.41ohm max.	-55°C to +125°C	Kit
BLM15BX601SN1□	600ohm ±25%	350mA	0.46ohm max.	-55°C to +125°C	Kit
BLM15BX102SN1□	1000ohm ±25%	300mA	0.65ohm max.	-55°C to +125°C	Kit
BLM15BX182SN1□	1800ohm ±25%	250mA	0.90ohm max.	-55°C to +125°C	Kit

Number of Circuits: 1

### ■ Impedance-Frequency Characteristics

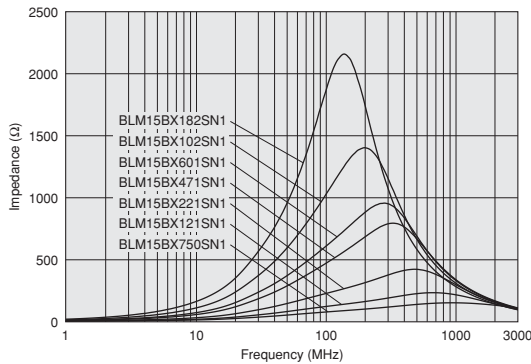

Continued on the following page.

△Note • Please read rating and △CAUTION (for storage, operating, rating, soldering, mounting and handling) in this catalog to prevent smoking and/or burning, etc.  
• This catalog has only typical specifications. Therefore, please approve our product specifications or transact the approval sheet for product specifications before ordering.

Impedance-Frequency Characteristics

BLM15BX750SN1

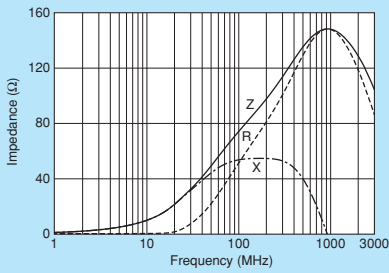

BLM15BX121SN1

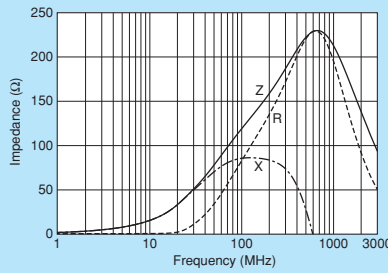

BLM15BX221SN1

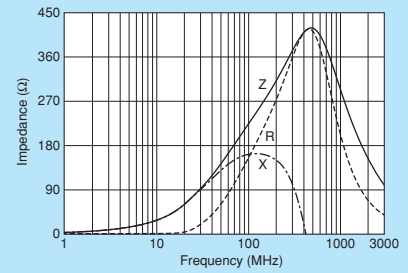

BLM15BX471SN1

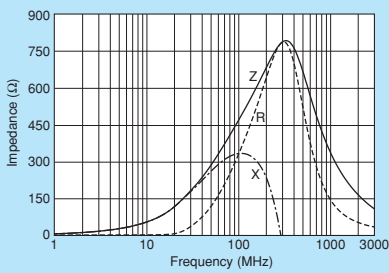

BLM15BX601SN1

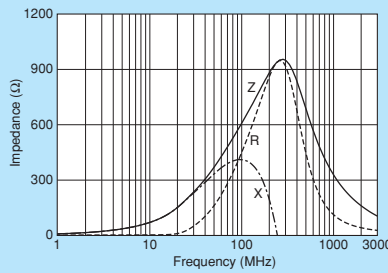

BLM15BX102SN1

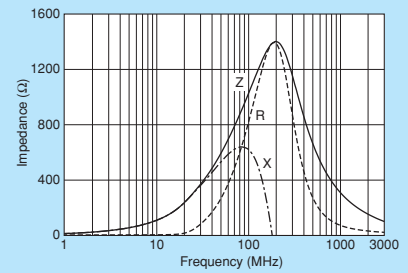

BLM15BX182SN1

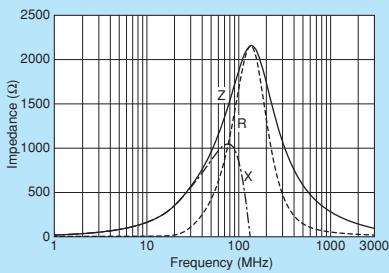

0402/1005 (inch/mm)  
Chip Ferrite Bead

Chip EMIFIL®

Chip Common Mode Choke Coil

Block Type EMIFIL®

Microwave Absorber

⚠Note • Please read rating and ⚠CAUTION (for storage, operating, rating, soldering, mounting and handling) in this catalog to prevent smoking and/or burning, etc.  
 • This catalog has only typical specifications. Therefore, please approve our product specifications or transact the approval sheet for product specifications before ordering.

# BLM15B Series 0402/1005 (inch/mm)



0402 size for high speed signal lines.

Chip Ferrite Bead  
0402/1005 (inch/mm)

Chip EMIFIL®

Chip Common Mode Choke Coil

Block Type EMIFIL®

Microwave Absorber

### ■ Dimensions

(in mm)

### ■ Equivalent Circuit

(Resistance element becomes dominant at high frequencies.)

### ■ Packaging

Code	Packaging	Minimum Quantity
D	180mm Reel Paper Tape	10000
J	330mm Reel Paper Tape	50000
B	Bulk(Bag)	1000

Refer to pages from p.100 to p.103 for mounting information.

### ■ Rated Value (□: packaging code)

Part Number	Impedance (at 100MHz/20°C)	Rated Current	DC Resistance	Operating Temperature Range	
BLM15BD750SN1□	75ohm ±25%	300mA	0.20ohm max.	-55°C to +125°C	Kit
BLM15BD121SN1□	120ohm ±25%	300mA	0.30ohm max.	-55°C to +125°C	Kit
BLM15BD221SN1□	220ohm ±25%	300mA	0.40ohm max.	-55°C to +125°C	Kit
BLM15BD471SN1□	470ohm ±25%	200mA	0.60ohm max.	-55°C to +125°C	Kit
BLM15BD601SN1□	600ohm ±25%	200mA	0.65ohm max.	-55°C to +125°C	Kit
BLM15BD102SN1□	1000ohm ±25%	200mA	0.90ohm max.	-55°C to +125°C	Kit
BLM15BD182SN1□	1800ohm ±25%	100mA	1.40ohm max.	-55°C to +125°C	Kit
BLM15BB050SN1□	5ohm ±25%	500mA	0.08ohm max.	-55°C to +125°C	Kit
BLM15BB100SN1□	10ohm ±25%	300mA	0.10ohm max.	-55°C to +125°C	Kit
BLM15BB220SN1□	22ohm ±25%	300mA	0.20ohm max.	-55°C to +125°C	Kit
BLM15BB470SN1□	47ohm ±25%	300mA	0.35ohm max.	-55°C to +125°C	Kit
BLM15BB750SN1□	75ohm ±25%	300mA	0.40ohm max.	-55°C to +125°C	Kit
BLM15BB121SN1□	120ohm ±25%	300mA	0.55ohm max.	-55°C to +125°C	Kit
BLM15BB221SN1□	220ohm ±25%	200mA	0.80ohm max.	-55°C to +125°C	Kit
BLM15BC121SN1□	120ohm ±25%	350mA	0.45ohm max.	-55°C to +125°C	Kit
BLM15BC241SN1□	240ohm ±25%	250mA	0.70ohm max.	-55°C to +125°C	Kit
BLM15BA050SN1□	5ohm ±25%	300mA	0.10ohm max.	-55°C to +125°C	Kit
BLM15BA100SN1□	10ohm ±25%	300mA	0.20ohm max.	-55°C to +125°C	Kit
BLM15BA220SN1□	22ohm ±25%	300mA	0.30ohm max.	-55°C to +125°C	Kit
BLM15BA330SN1□	33ohm ±25%	300mA	0.40ohm max.	-55°C to +125°C	Kit
BLM15BA470SN1□	47ohm ±25%	200mA	0.60ohm max.	-55°C to +125°C	Kit
BLM15BA750SN1□	75ohm ±25%	200mA	0.80ohm max.	-55°C to +125°C	Kit

Number of Circuits: 1

Continued on the following page.

△Note • Please read rating and △CAUTION (for storage, operating, rating, soldering, mounting and handling) in this catalog to prevent smoking and/or burning, etc.  
• This catalog has only typical specifications. Therefore, please approve our product specifications or transact the approval sheet for product specifications before ordering.



Impedance-Frequency Characteristics

BLM15BD Series

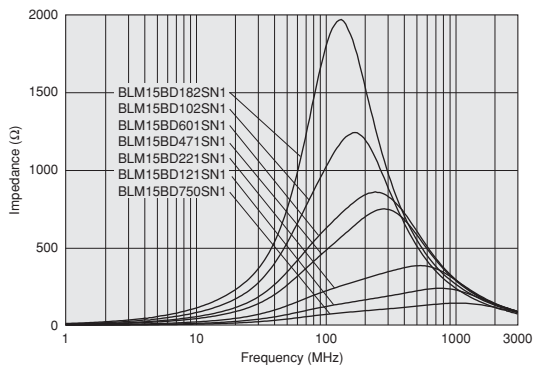

BLM15BB Series

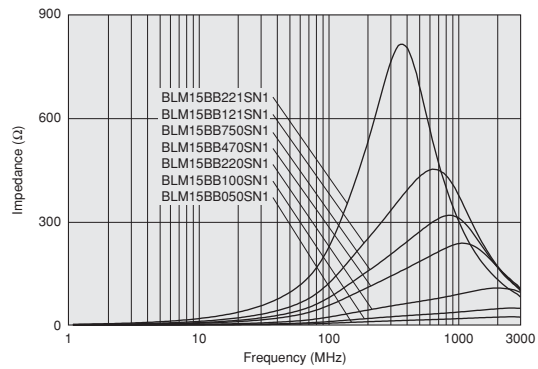

BLM15BC Series

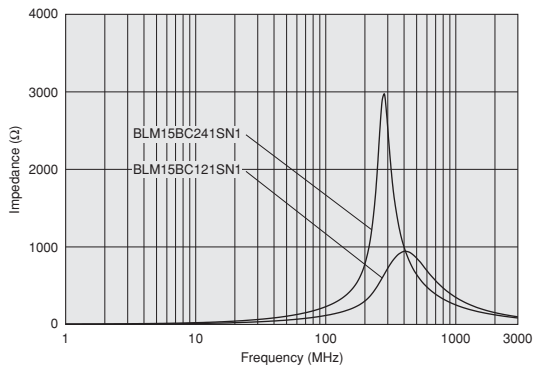

BLM15BA Series

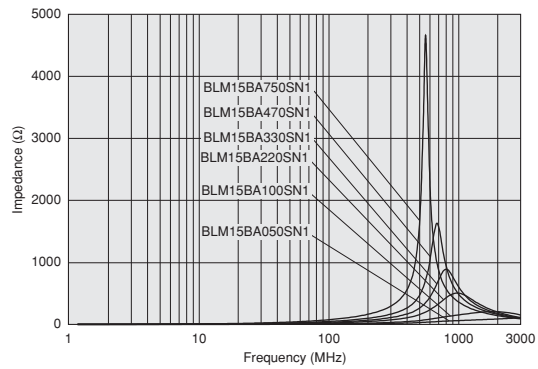

Impedance-Frequency Characteristics

BLM15BD750SN1

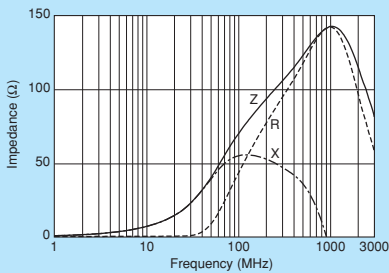

BLM15BD121SN1

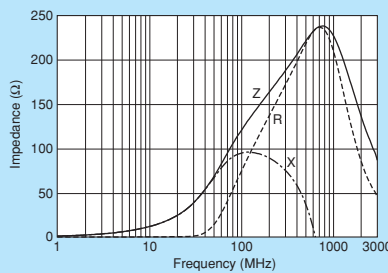

BLM15BD221SN1

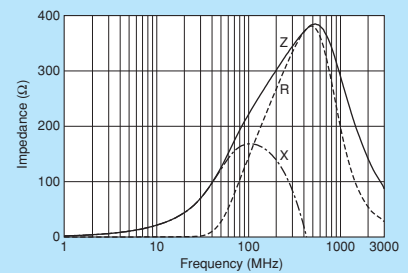

BLM15BD471SN1

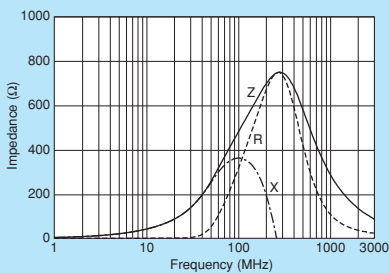

BLM15BD601SN1

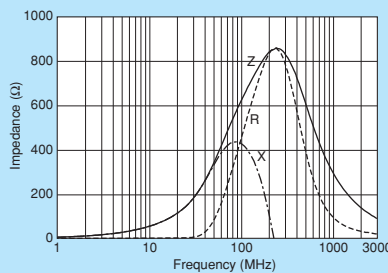

BLM15BD102SN1

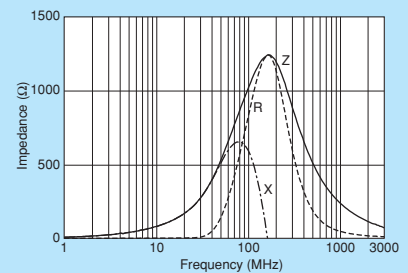

Continued on the following page.

**Note** • Please read rating and **CAUTION** (for storage, operating, rating, soldering, mounting and handling) in this catalog to prevent smoking and/or burning, etc.  
 • This catalog has only typical specifications. Therefore, please approve our product specifications or transact the approval sheet for product specifications before ordering.

Impedance-Frequency Characteristics

Chip Ferrite Bead  
 0402/1005 (inch/mm)

Chip EMIFIL®

Chip Common Mode Choke Coil

Block Type EMIFIL®

Microwave Absorber

BLM15BD182SN1

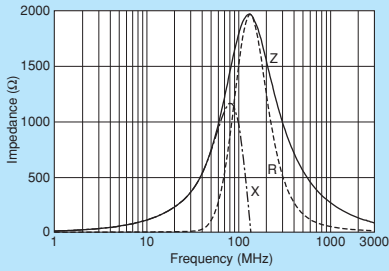

BLM15BB050SN1

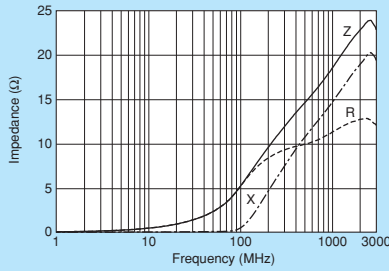

BLM15BB100SN1

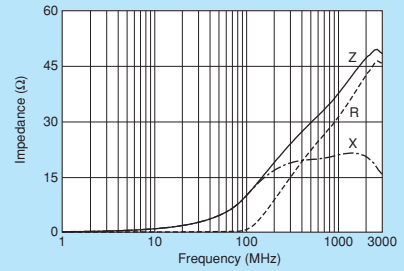

BLM15BB220SN1

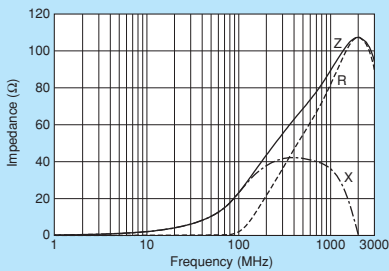

BLM15BB470SN1

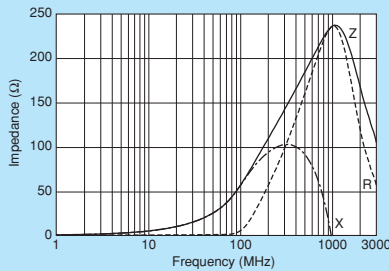

BLM15BB750SN1

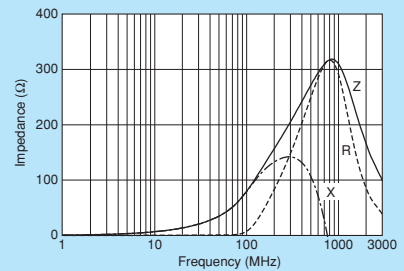

BLM15BB121SN1

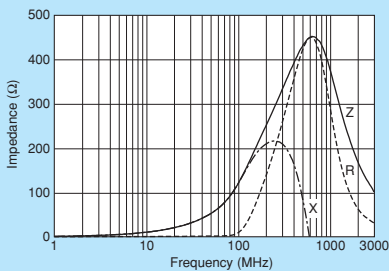

BLM15BB221SN1

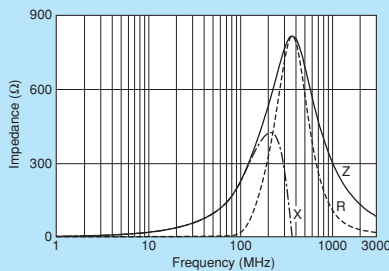

BLM15BC121SN1

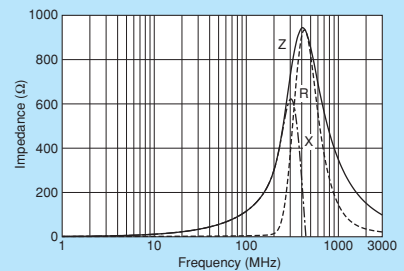

BLM15BC241SN1

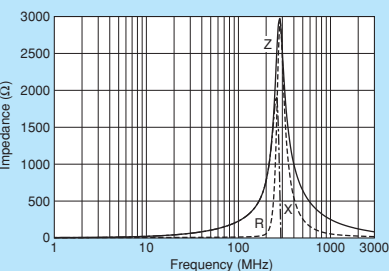

BLM15BA050SN1

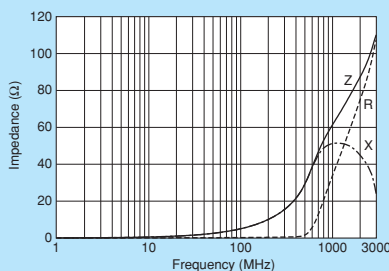

BLM15BA100SN1

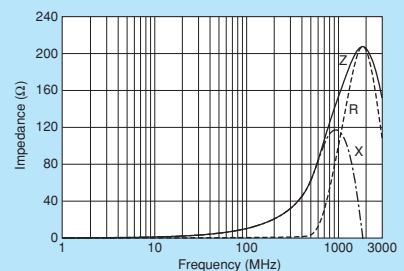

BLM15BA220SN1

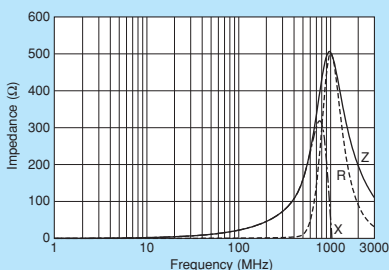

BLM15BA330SN1

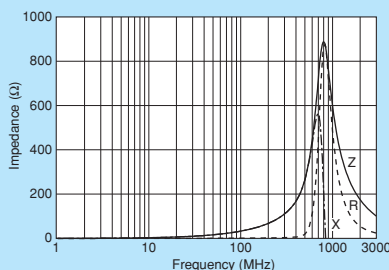

BLM15BA470SN1

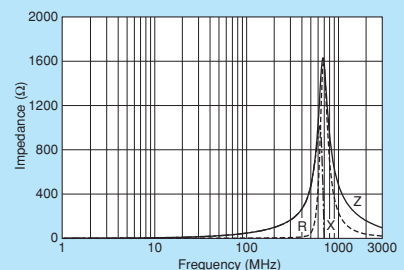

Continued on the following page.

⚠ Note • Please read rating and ⚠ CAUTION (for storage, operating, rating, soldering, mounting and handling) in this catalog to prevent smoking and/or burning, etc.  
 • This catalog has only typical specifications. Therefore, please approve our product specifications or transact the approval sheet for product specifications before ordering.

■ Impedance-Frequency Characteristics

BLM15BA750SN1

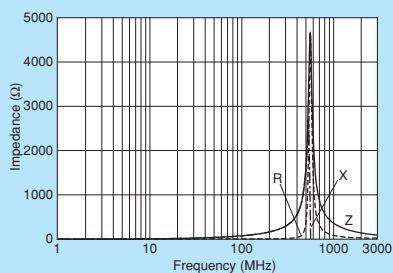

0402/1005 (inch/mm)  
 Chip Ferrite Bead

Chip EMIFIL®

Chip Common Mode Choke Coil

Block Type EMIFIL®

Microwave Absorber

⚠Note • Please read rating and ⚠CAUTION (for storage, operating, rating, soldering, mounting and handling) in this catalog to prevent smoking and/or burning, etc.  
 • This catalog has only typical specifications. Therefore, please approve our product specifications or transact the approval sheet for product specifications before ordering.

# BLM18P Series 0603/1608 (inch/mm)



## 0603 size for power lines.

\*Please refer to the products designed for both power lines and signal lines.

Chip Ferrite Bead  
0603/1608 (inch/mm)

Chip EMIFIL®

Chip Common Mode Choke Coil

Block Type EMIFIL®

Microwave Absorber

### ■ Dimensions

0.4±0.2  
1.6±0.15  
0.8±0.15  
0.8±0.15

Legend:  Electrode (in mm)

### ■ Equivalent Circuit

(Resistance element becomes dominant at high frequencies.)

### ■ Packaging

Code	Packaging	Minimum Quantity
D	180mm Reel Paper Tape	4000
J	330mm Reel Paper Tape	10000
B	Bulk(Bag)	1000

Refer to pages from p.100 to p.103 for mounting information.

### ■ Rated Value (□: packaging code)

Part Number	Impedance (at 100MHz/20°C)	Rated Current	DC Resistance	Operating Temperature Range	
BLM18PG300SN1□	30ohm (Typ.)	1000mA	0.05ohm max.	-55°C to +125°C	Kit ≥1A
BLM18PG330SN1□	33ohm ±25%	3000mA	0.025ohm max.	-55°C to +125°C	Kit ≥3A
BLM18PG600SN1□	60ohm (Typ.)	500mA	0.10ohm max.	-55°C to +125°C	Kit
BLM18PG121SN1□	120ohm ±25%	2000mA	0.05ohm max.	-55°C to +125°C	Kit ≥1A
BLM18PG181SN1□	180ohm ±25%	1500mA	0.09ohm max.	-55°C to +125°C	Kit ≥1A
BLM18PG221SN1□	220ohm ±25%	1400mA	0.10ohm max.	-55°C to +125°C	Kit ≥1A
BLM18PG331SN1□	330ohm ±25%	1200mA	0.15ohm max.	-55°C to +125°C	Kit ≥1A
BLM18PG471SN1□	470ohm ±25%	1000mA	0.20ohm max.	-55°C to +125°C	Kit ≥1A

Number of Circuits: 1

### ■ Impedance-Frequency Characteristics

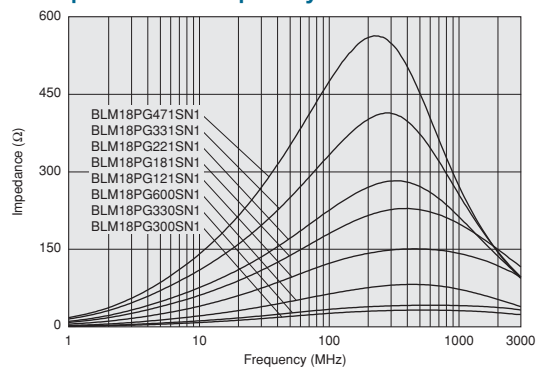

### ■ Notice (Rating)

In operating temperature exceeding +85°C, derating of current is necessary for BLM18PG series.

Please apply the derating curve shown in chart according to the operating temperature.

Derating of Rated Current

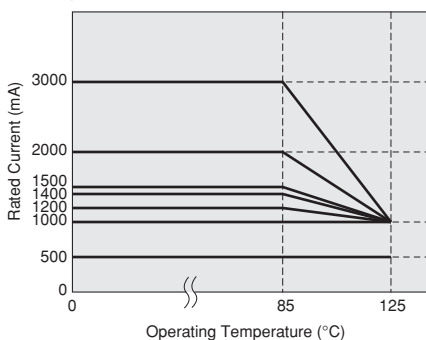

Continued on the following page. ↗

△Note • Please read rating and △CAUTION (for storage, operating, rating, soldering, mounting and handling) in this catalog to prevent smoking and/or burning, etc.  
• This catalog has only typical specifications. Therefore, please approve our product specifications or transact the approval sheet for product specifications before ordering.

Impedance-Frequency Characteristics

BLM18PG300SN1

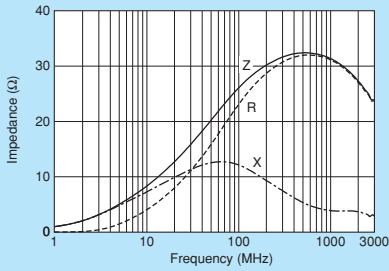

BLM18PG330SN1

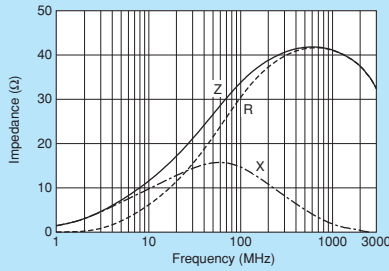

BLM18PG600SN1

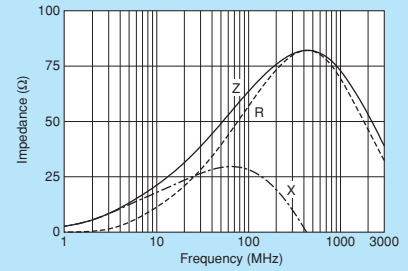

BLM18PG121SN1

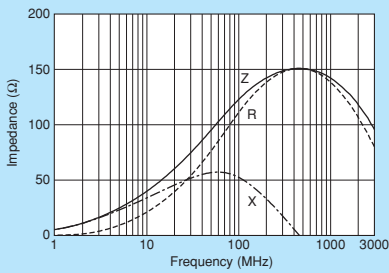

BLM18PG181SN1

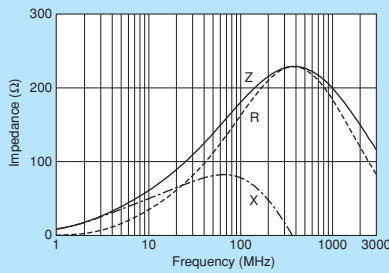

BLM18PG221SN1

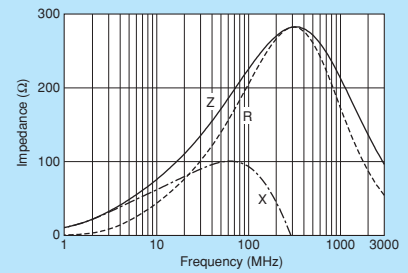

BLM18PG331SN1

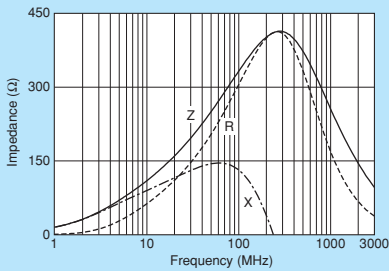

BLM18PG471SN1

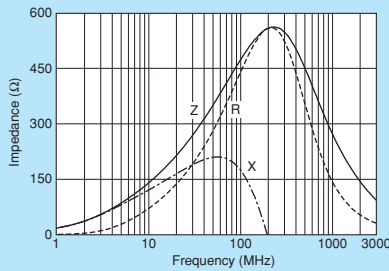

0603/1608 (inch/mm)  
Chip Ferrite Bead

Chip EMIFIL®

Chip Common Mode Choke Coil

Block Type EMIFIL®

Microwave Absorber

⚠Note • Please read rating and ⚠CAUTION (for storage, operating, rating, soldering, mounting and handling) in this catalog to prevent smoking and/or burning, etc.  
 • This catalog has only typical specifications. Therefore, please approve our product specifications or transact the approval sheet for product specifications before ordering.

# BLM18K Series 0603/1608 (inch/mm)



6A max., high performance type for power lines up to 600ohm.

\*Please refer to the products designed for both power lines and signal lines.

Chip Ferrite Bead  
0603/1608 (inch/mm)

Chip EMIFIL®

Chip Common Mode Choke Coil

Block Type EMIFIL®

Microwave Absorber



### ■ Dimensions

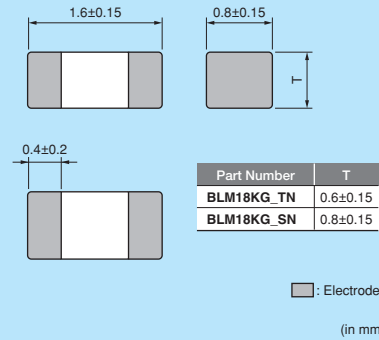

### ■ Equivalent Circuit

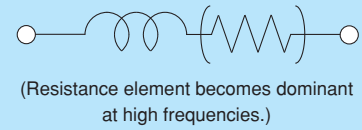

### ■ Packaging

Code	Packaging	Minimum Quantity
D	180mm Reel Paper Tape	4000
J	330mm Reel Paper Tape	10000
B	Bulk(Bag)	1000

Refer to pages from p.100 to p.103 for mounting information.

### ■ Rated Value (□: packaging code)

Part Number	Impedance (at 100MHz/20°C)	Rated Current	DC Resistance	Operating Temperature Range	Kit	Current
BLM18KG260TN1□	26ohm ±25%	6000mA	0.007ohm max.	-55°C to +125°C	Kit	≥3A
BLM18KG300TN1□	30ohm ±25%	5000mA	0.010ohm max.	-55°C to +125°C	Kit	≥3A
BLM18KG700TN1□	70ohm ±25%	3500mA	0.022ohm max.	-55°C to +125°C	Kit	≥3A
BLM18KG101TN1□	100ohm ±25%	3000mA	0.030ohm max.	-55°C to +125°C	Kit	≥3A
BLM18KG121TN1□	120ohm ±25%	3000mA	0.030ohm max.	-55°C to +125°C	Kit	≥3A
BLM18KG221SN1□	220ohm ±25%	2200mA	0.050ohm max.	-55°C to +125°C	Kit	≥1A
BLM18KG331SN1□	330ohm ±25%	1700mA	0.080ohm max.	-55°C to +125°C	Kit	≥1A
BLM18KG471SN1□	470ohm ±25%	1500mA	0.130ohm max.	-55°C to +125°C	Kit	≥1A
BLM18KG601SN1□	600ohm ±25%	1300mA	0.150ohm max.	-55°C to +125°C	Kit	≥1A

Number of Circuits: 1

### ■ Impedance-Frequency Characteristics

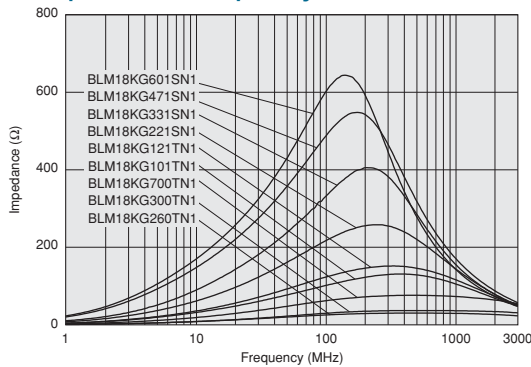

### ■ Notice (Rating)

In operating temperature exceeding +85°C, derating of current is necessary for BLM18KG series. Please apply the derating curve shown in chart according to the operating temperature.

Derating of Rated Current

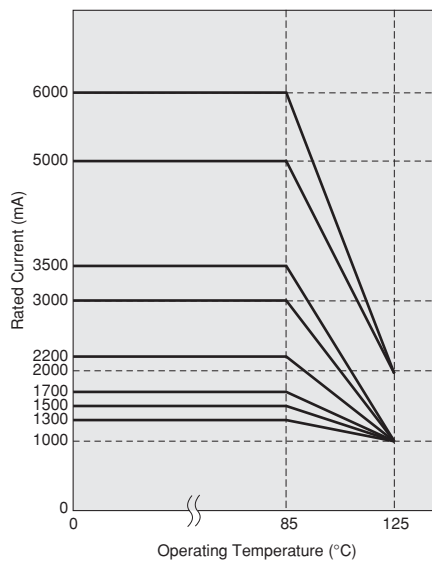

Continued on the following page.

△Note • Please read rating and △CAUTION (for storage, operating, rating, soldering, mounting and handling) in this catalog to prevent smoking and/or burning, etc.  
• This catalog has only typical specifications. Therefore, please approve our product specifications or transact the approval sheet for product specifications before ordering.

Impedance-Frequency Characteristics

BLM18KG260TN1

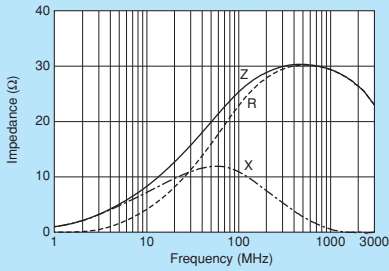

BLM18KG300TN1

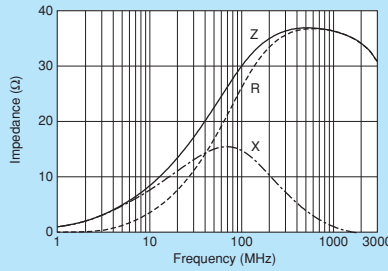

BLM18KG700TN1

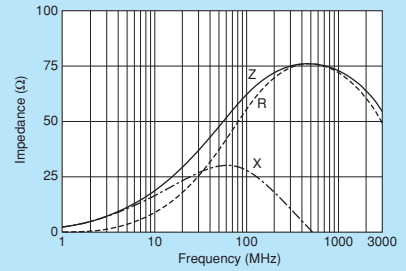

BLM18KG101TN1

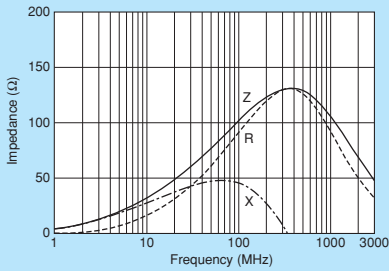

BLM18KG121TN1

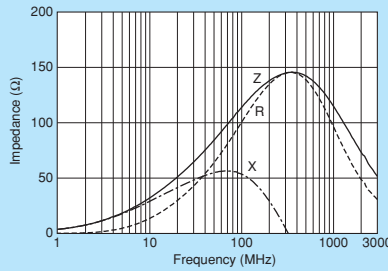

BLM18KG221SN1

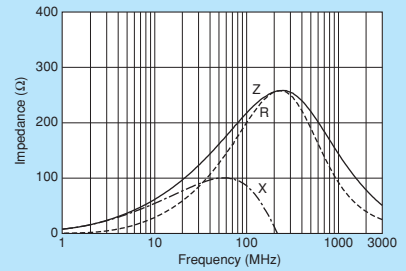

BLM18KG331SN1

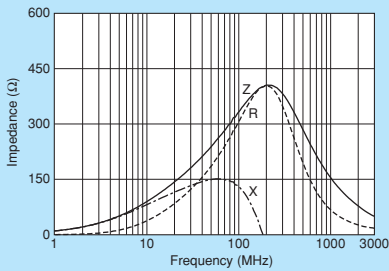

BLM18KG471SN1

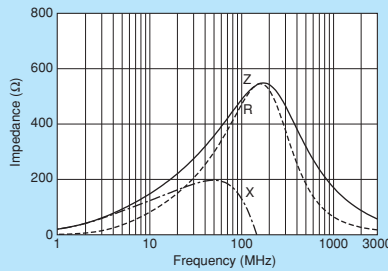

BLM18KG601SN1

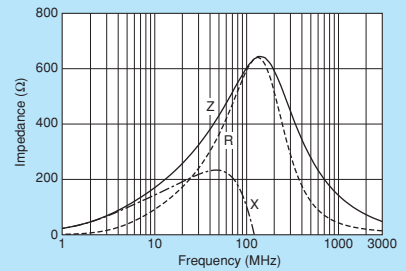

0603/1608 (inch/mm)  
Chip Ferrite Bead

Chip EMIFIL®

Chip Common Mode Choke Coil

Block Type EMIFIL®

Microwave Absorber

⚠Note • Please read rating and ⚠CAUTION (for storage, operating, rating, soldering, mounting and handling) in this catalog to prevent smoking and/or burning, etc.  
 • This catalog has only typical specifications. Therefore, please approve our product specifications or transact the approval sheet for product specifications before ordering.

# BLM18S Series 0603/1608 (inch/mm)



6A max., high performance type for power lines.

\*Please refer to the products designed for both power lines and signal lines.

Chip Ferrite Bead  
0603/1608 (inch/mm)

Chip EMIFIL®

Chip Common Mode Choke Coil

Block Type EMIFIL®

Microwave Absorber



### ■ Dimensions

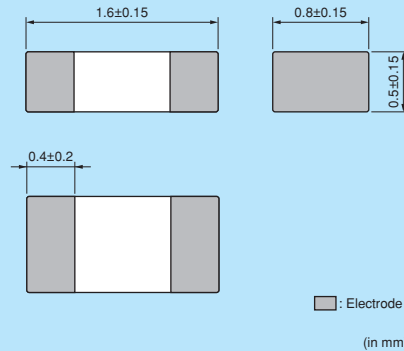

### ■ Equivalent Circuit

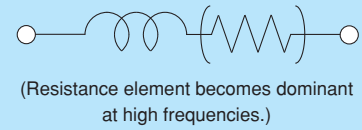

### ■ Packaging

Code	Packaging	Minimum Quantity
D	180mm Reel Paper Tape	10000
J	330mm Reel Paper Tape	30000
B	Bulk(Bag)	1000

Refer to pages from p.100 to p.103 for mounting information.

### ■ Rated Value (□: packaging code)

Part Number	Impedance (at 100MHz/20°C)	Rated Current	DC Resistance	Operating Temperature Range	Kit	≥3A
BLM18SG260TN1□	26ohm ±25%	6000mA	0.007ohm max.	-55°C to +125°C	Kit	≥3A
BLM18SG700TN1□	70ohm ±25%	4000mA	0.020ohm max.	-55°C to +125°C	Kit	≥3A
BLM18SG121TN1□	120ohm ±25%	3000mA	0.025ohm max.	-55°C to +125°C	Kit	≥3A
BLM18SG221TN1□	220ohm ±25%	2500mA	0.040ohm max.	-55°C to +125°C	Kit	≥1A
BLM18SG331TN1□	330ohm ±25%	1500mA	0.070ohm max.	-55°C to +125°C	Kit	≥1A

Number of Circuits: 1

### ■ Impedance-Frequency Characteristics

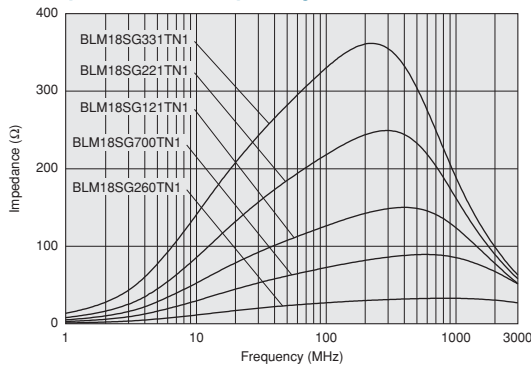

### ■ Notice (Rating)

In operating temperature exceeding +85°C, derating of current is necessary for BLM18SG series.

Please apply the derating curve shown in chart according to the operating temperature.

Derating of Rated Current

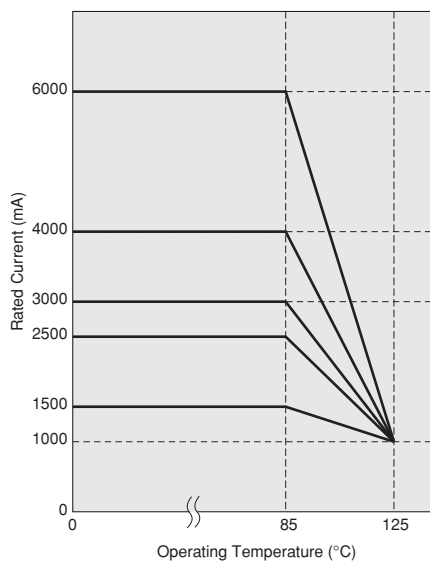

Continued on the following page.

△Note • Please read rating and △CAUTION (for storage, operating, rating, soldering, mounting and handling) in this catalog to prevent smoking and/or burning, etc.  
• This catalog has only typical specifications. Therefore, please approve our product specifications or transact the approval sheet for product specifications before ordering.



Impedance-Frequency Characteristics

BLM18SG260TN1

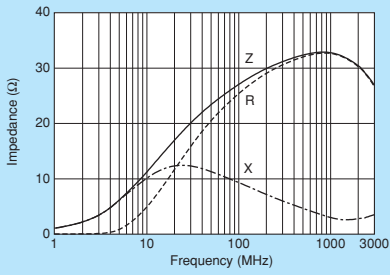

BLM18SG700TN1

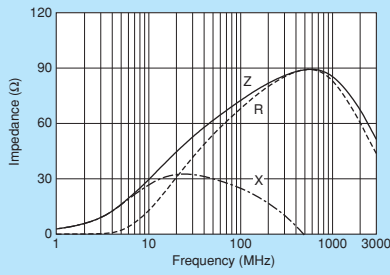

BLM18SG121TN1

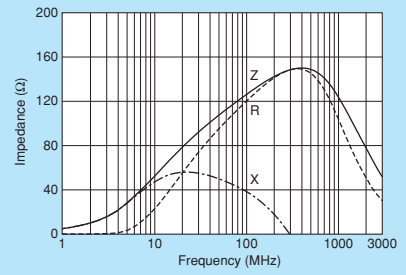

BLM18SG221TN1

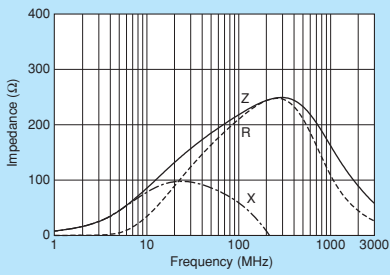

BLM18SG331TN1

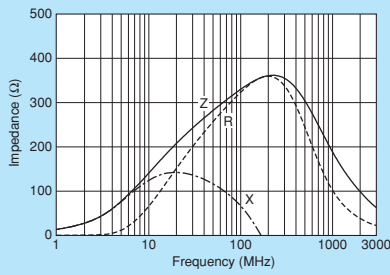

0603/1608 (inch/mm)  
 Chip Ferrite Bead

Chip EMIFIL®

Chip Common Mode Choke Coil

Block Type EMIFIL®

Microwave Absorber

⚠Note • Please read rating and ⚠CAUTION (for storage, operating, rating, soldering, mounting and handling) in this catalog to prevent smoking and/or burning, etc.  
 • This catalog has only typical specifications. Therefore, please approve our product specifications or transact the approval sheet for product specifications before ordering.

# BLM18A Series 0603/1608 (inch/mm)



## 0603 size for general signal lines.

\*Please refer to BLM15A for downsizing.

Chip Ferrite Bead  
0603/1608 (inch/mm)

Chip EMIFIL®

Chip Common Mode Choke Coil

Block Type EMIFIL®

Microwave Absorber

### ■ Dimensions

(in mm)

### ■ Equivalent Circuit

(Resistance element becomes dominant at high frequencies.)

### ■ Packaging

Code	Packaging	Minimum Quantity
D	180mm Reel Paper Tape	4000
J	330mm Reel Paper Tape	10000
B	Bulk(Bag)	1000

Refer to pages from p.100 to p.103 for mounting information.

### ■ Rated Value (□: packaging code)

Part Number	Impedance (at 100MHz/20°C)	Rated Current	DC Resistance	Operating Temperature Range	
BLM18AG121SN1□	120ohm ±25%	500mA	0.18ohm max.	-55°C to +125°C	Kit
BLM18AG151SN1□	150ohm ±25%	500mA	0.25ohm max.	-55°C to +125°C	Kit
BLM18AG221SN1□	220ohm ±25%	500mA	0.25ohm max.	-55°C to +125°C	Kit
BLM18AG331SN1□	330ohm ±25%	500mA	0.30ohm max.	-55°C to +125°C	Kit
BLM18AG471SN1□	470ohm ±25%	500mA	0.35ohm max.	-55°C to +125°C	Kit
BLM18AG601SN1□	600ohm ±25%	500mA	0.38ohm max.	-55°C to +125°C	Kit
BLM18AG102SN1□	1000ohm ±25%	400mA	0.50ohm max.	-55°C to +125°C	Kit

Number of Circuits: 1

### ■ Impedance-Frequency Characteristics

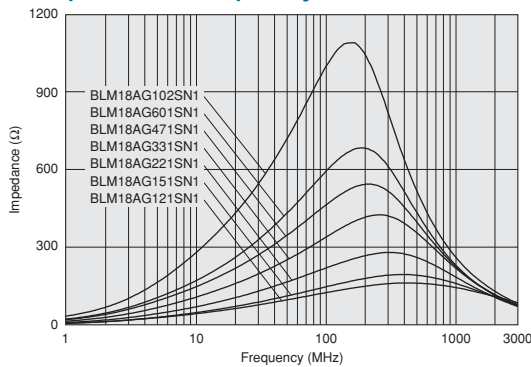

### ■ Impedance-Frequency Characteristics

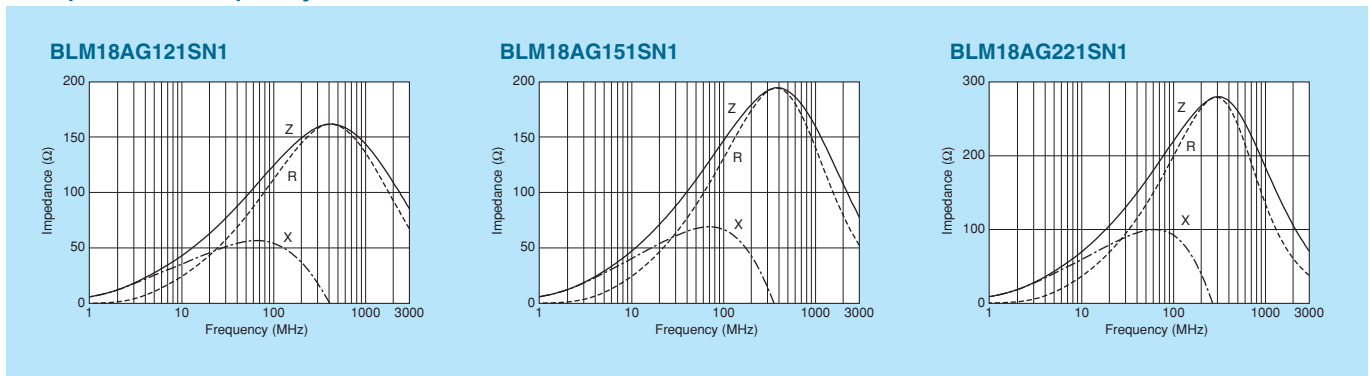

Continued on the following page.

△Note • Please read rating and △CAUTION (for storage, operating, rating, soldering, mounting and handling) in this catalog to prevent smoking and/or burning, etc.  
• This catalog has only typical specifications. Therefore, please approve our product specifications or transact the approval sheet for product specifications before ordering.

Impedance-Frequency Characteristics

BLM18AG331SN1

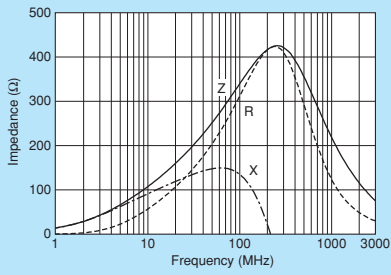

BLM18AG471SN1

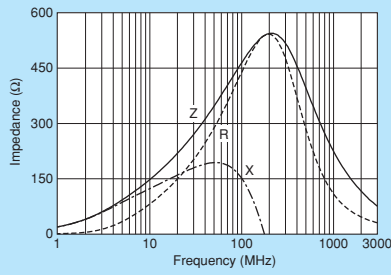

BLM18AG601SN1

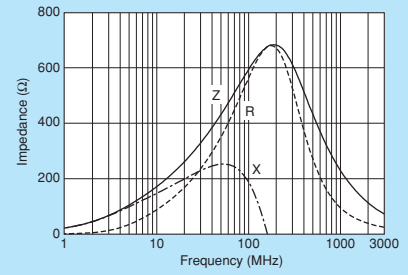

BLM18AG102SN1

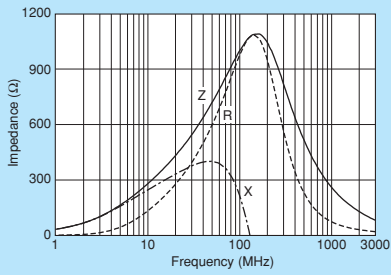

0603/1608 (inch/mm)  
Chip Ferrite Bead

Chip EMIFIL®

Chip Common Mode Choke Coil

Block Type EMIFIL®

Microwave Absorber

⚠ Note • Please read rating and ⚠ CAUTION (for storage, operating, rating, soldering, mounting and handling) in this catalog to prevent smoking and/or burning, etc.  
 • This catalog has only typical specifications. Therefore, please approve our product specifications or transact the approval sheet for product specifications before ordering.

# BLM18B Series 0603/1608 (inch/mm)



0603 size for high speed signal lines.

\*Please refer to BLM15B for downsizing.



### ■ Dimensions

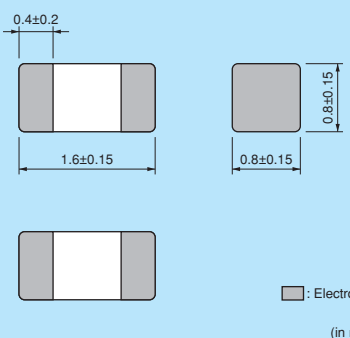

(in mm)

### ■ Equivalent Circuit



(Resistance element becomes dominant at high frequencies.)

### ■ Packaging

Code	Packaging	Minimum Quantity
D	180mm Reel Paper Tape	4000
J	330mm Reel Paper Tape	10000
B	Bulk(Bag)	1000

Refer to pages from p.100 to p.103 for mounting information.

## ■ Rated Value (□: packaging code)

Part Number	Impedance (at 100MHz/20°C)	Rated Current	DC Resistance	Operating Temperature Range	
BLM18BD470SN1□	47ohm ±25%	500mA	0.30ohm max.	-55°C to +125°C	Kit
BLM18BD121SN1□	120ohm ±25%	200mA	0.40ohm max.	-55°C to +125°C	Kit
BLM18BD151SN1□	150ohm ±25%	200mA	0.40ohm max.	-55°C to +125°C	Kit
BLM18BD221SN1□	220ohm ±25%	200mA	0.45ohm max.	-55°C to +125°C	Kit
BLM18BD331SN1□	330ohm ±25%	200mA	0.50ohm max.	-55°C to +125°C	Kit
BLM18BD421SN1□	420ohm ±25%	200mA	0.55ohm max.	-55°C to +125°C	Kit
BLM18BD471SN1□	470ohm ±25%	200mA	0.55ohm max.	-55°C to +125°C	Kit
BLM18BD601SN1□	600ohm ±25%	200mA	0.65ohm max.	-55°C to +125°C	Kit
BLM18BD102SN1□	1000ohm ±25%	100mA	0.85ohm max.	-55°C to +125°C	Kit
BLM18BD152SN1□	1500ohm ±25%	50mA	1.20ohm max.	-55°C to +125°C	Kit
BLM18BD182SN1□	1800ohm ±25%	50mA	1.50ohm max.	-55°C to +125°C	Kit
BLM18BD222SN1□	2200ohm ±25%	50mA	1.50ohm max.	-55°C to +125°C	Kit
BLM18BD252SN1□	2500ohm ±25%	50mA	1.50ohm max.	-55°C to +125°C	Kit
BLM18BB050SN1□	5ohm ±25%	700mA	0.05ohm max.	-55°C to +125°C	Kit
BLM18BB100SN1□	10ohm ±25%	700mA	0.10ohm max.	-55°C to +125°C	Kit
BLM18BB220SN1□	22ohm ±25%	600mA	0.20ohm max.	-55°C to +125°C	Kit
BLM18BB470SN1□	47ohm ±25%	550mA	0.25ohm max.	-55°C to +125°C	Kit
BLM18BB600SN1□	60ohm ±25%	550mA	0.25ohm max.	-55°C to +125°C	Kit
BLM18BB750SN1□	75ohm ±25%	500mA	0.30ohm max.	-55°C to +125°C	Kit
BLM18BB121SN1□	120ohm ±25%	500mA	0.30ohm max.	-55°C to +125°C	Kit
BLM18BB141SN1□	140ohm ±25%	450mA	0.35ohm max.	-55°C to +125°C	
BLM18BB151SN1□	150ohm ±25%	450mA	0.37ohm max.	-55°C to +125°C	Kit
BLM18BB221SN1□	220ohm ±25%	450mA	0.45ohm max.	-55°C to +125°C	Kit
BLM18BB331SN1□	330ohm ±25%	400mA	0.58ohm max.	-55°C to +125°C	Kit
BLM18BB471SN1□	470ohm ±25%	300mA	0.85ohm max.	-55°C to +125°C	Kit
BLM18BA050SN1□	5ohm ±25%	500mA	0.20ohm max.	-55°C to +125°C	Kit
BLM18BA100SN1□	10ohm ±25%	500mA	0.25ohm max.	-55°C to +125°C	Kit
BLM18BA220SN1□	22ohm ±25%	500mA	0.35ohm max.	-55°C to +125°C	
BLM18BA470SN1□	47ohm ±25%	300mA	0.55ohm max.	-55°C to +125°C	Kit
BLM18BA750SN1□	75ohm ±25%	300mA	0.70ohm max.	-55°C to +125°C	Kit
BLM18BA121SN1□	120ohm ±25%	200mA	0.90ohm max.	-55°C to +125°C	Kit

Number of Circuits: 1

Continued on the following page.

△Note • Please read rating and △CAUTION (for storage, operating, rating, soldering, mounting and handling) in this catalog to prevent smoking and/or burning, etc.  
 • This catalog has only typical specifications. Therefore, please approve our product specifications or transact the approval sheet for product specifications before ordering.

Chip Ferrite Bead 0603/1608 (inch/mm)

Chip EMIFIL®

Chip Common Mode Choke Coil

Block Type EMIFIL®

Microwave Absorber

**Impedance-Frequency Characteristics**  
 BLM18BD Series (47ohm to 420ohm)

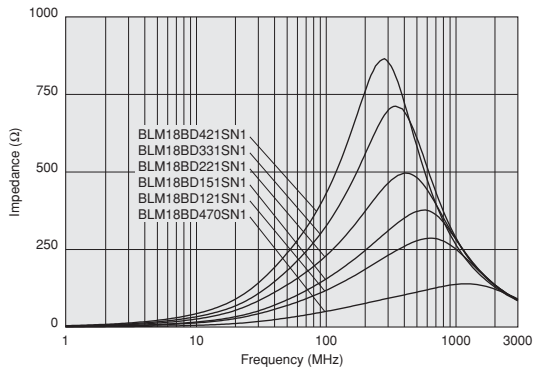

**BLM18BD Series (470ohm to 2500ohm)**

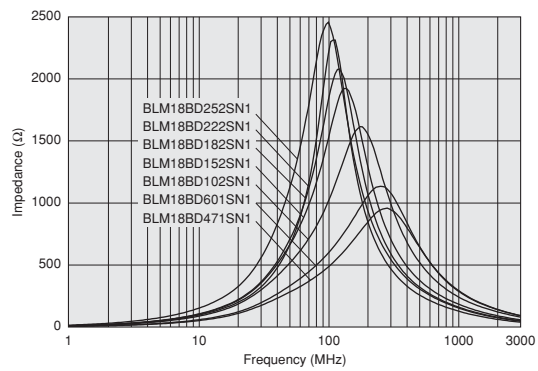

**BLM18BB Series (5ohm to 75ohm)**

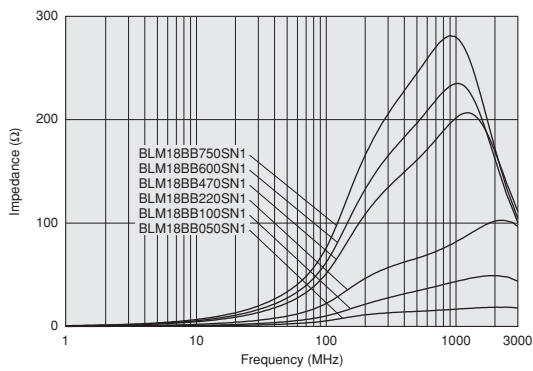

**BLM18BB Series (120ohm to 470ohm)**

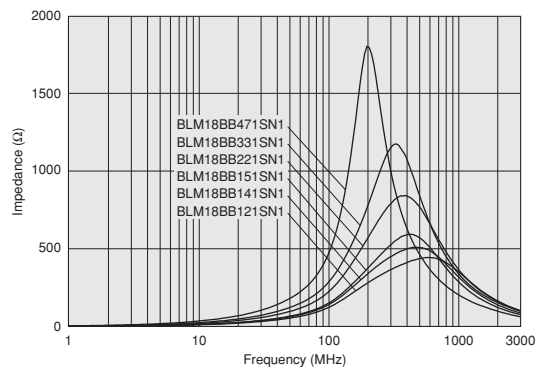

**BLM18BA Series (5ohm to 220ohm)**

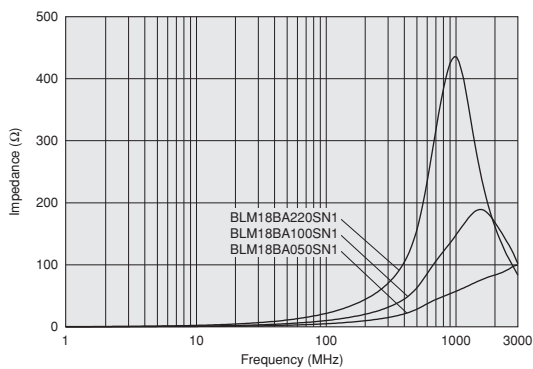

**BLM18BA Series (47ohm to 120ohm)**

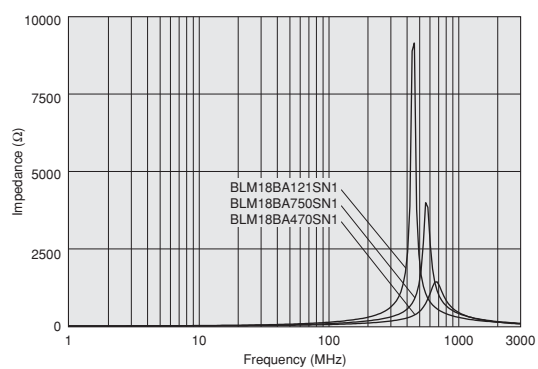

**Impedance-Frequency Characteristics**

**BLM18BD470SN1**

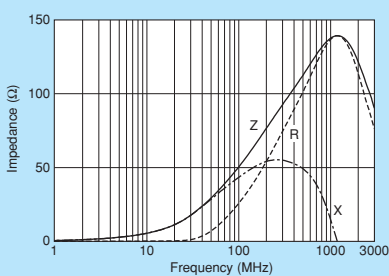

**BLM18BD121SN1**

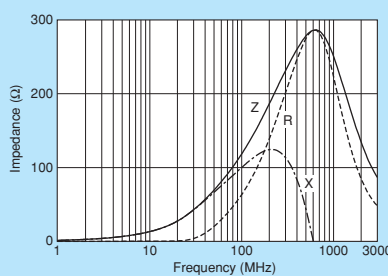

**BLM18BD151SN1**

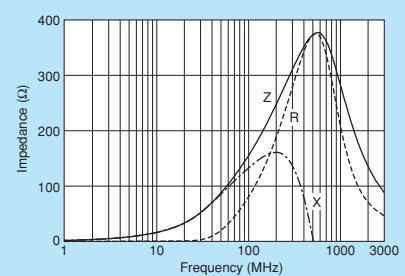

Continued on the following page.

**Note** • Please read rating and **CAUTION** (for storage, operating, rating, soldering, mounting and handling) in this catalog to prevent smoking and/or burning, etc.  
 • This catalog has only typical specifications. Therefore, please approve our product specifications or transact the approval sheet for product specifications before ordering.

Impedance-Frequency Characteristics

Chip Ferrite Bead  
 0603/1608 (inch/mm)

Chip EMIFIL®

Chip Common Mode Choke Coil

Block Type EMIFIL®

Microwave Absorber

BLM18BD221SN1

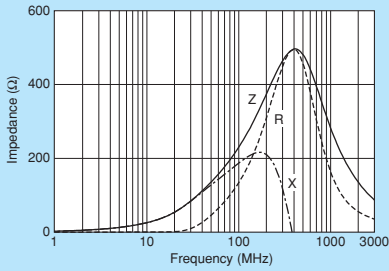

BLM18BD331SN1

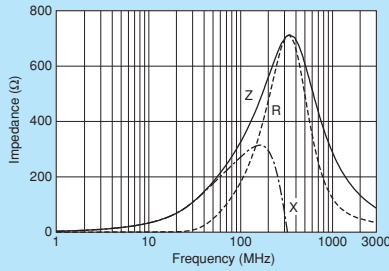

BLM18BD421SN1

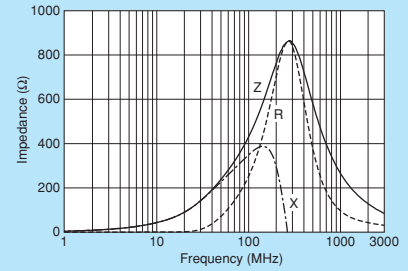

BLM18BD471SN1

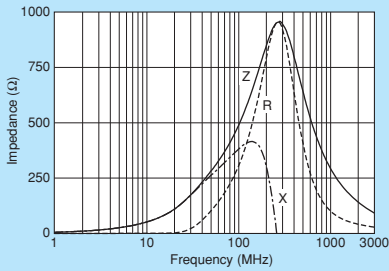

BLM18BD601SN1

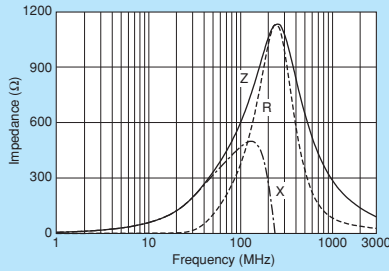

BLM18BD102SN1

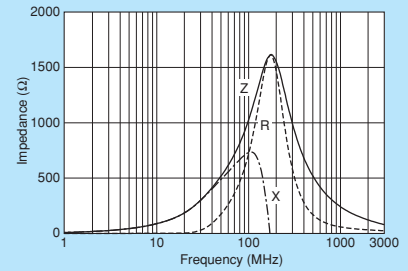

BLM18BD152SN1

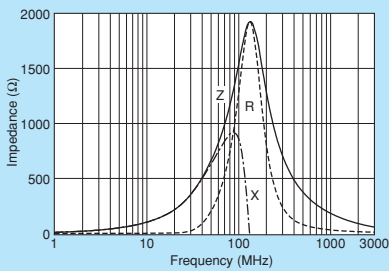

BLM18BD182SN1

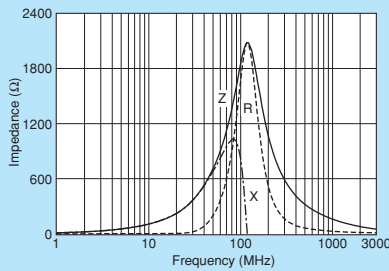

BLM18BD222SN1

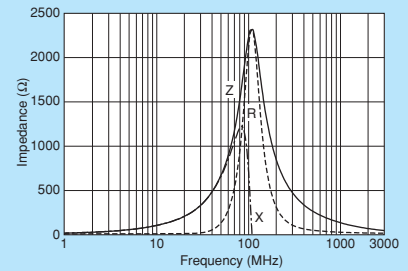

BLM18BD252SN1

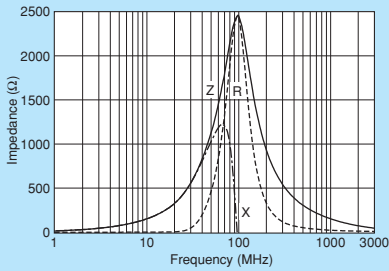

BLM18BB050SN1

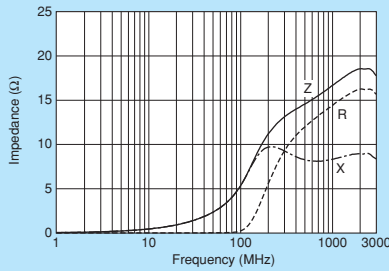

BLM18BB100SN1

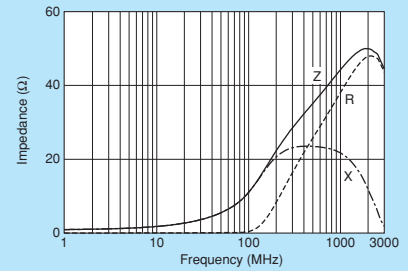

BLM18BB220SN1

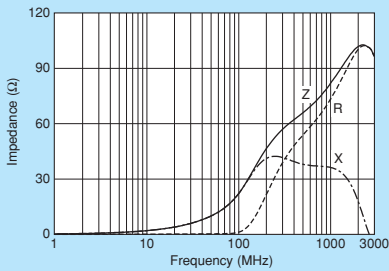

BLM18BB470SN1

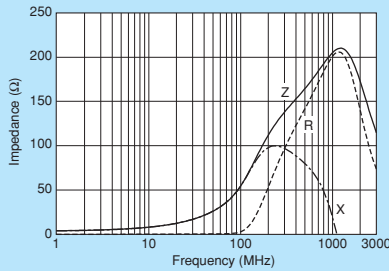

BLM18BB600SN1

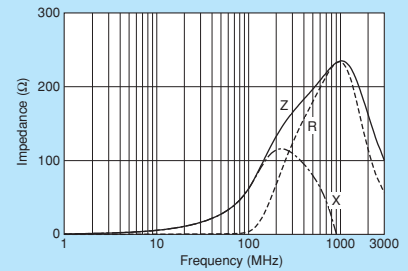

Continued on the following page.

⚠ Note • Please read rating and ⚠ CAUTION (for storage, operating, rating, soldering, mounting and handling) in this catalog to prevent smoking and/or burning, etc.  
 • This catalog has only typical specifications. Therefore, please approve our product specifications or transact the approval sheet for product specifications before ordering.

Impedance-Frequency Characteristics

BLM18BB750SN1

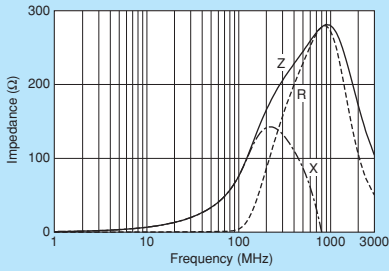

BLM18BB121SN1

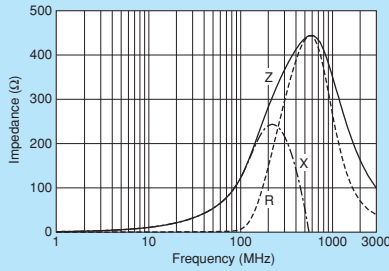

BLM18BB141SN1

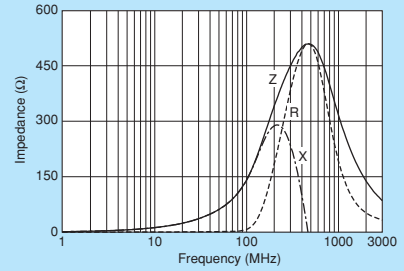

BLM18BB151SN1

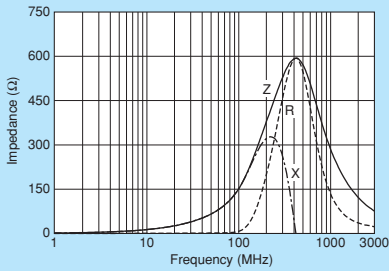

BLM18BB221SN1

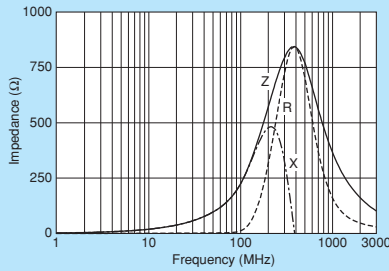

BLM18BB331SN1

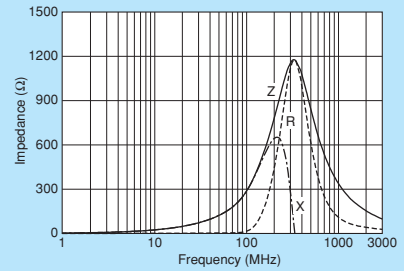

BLM18BB471SN1

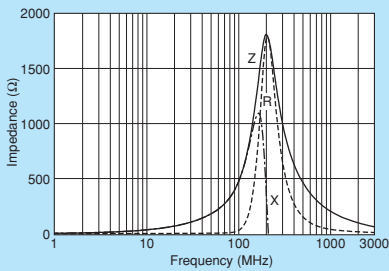

BLM18BA050SN1

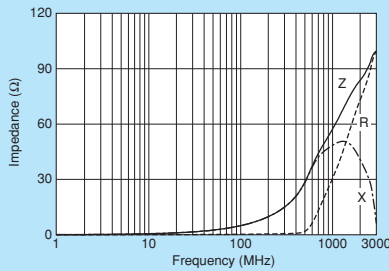

BLM18BA100SN1

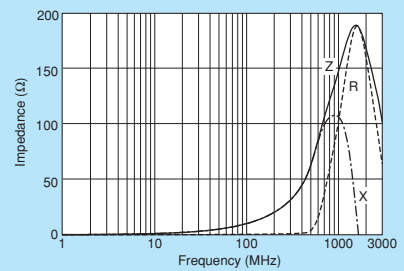

BLM18BA220SN1

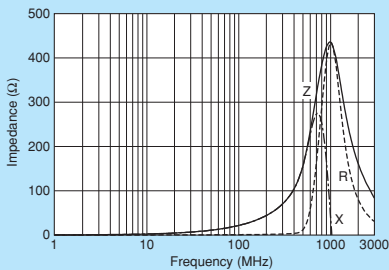

BLM18BA470SN1

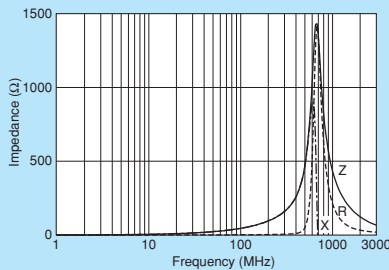

BLM18BA750SN1

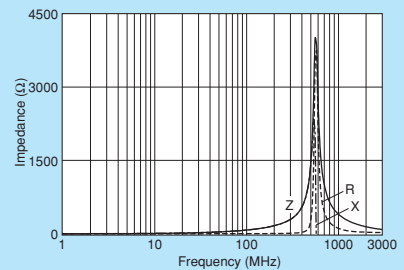

BLM18BA121SN1

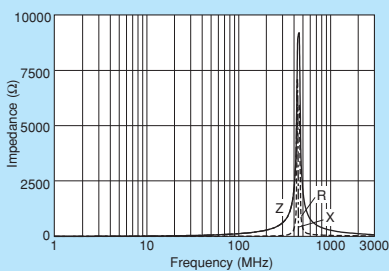

0603/1608 (inch/mm)  
Chip Ferrite Bead

Chip EMIFIL®

Chip Common Mode Choke Coil

Block Type EMIFIL®

Microwave Absorber

⚠Note • Please read rating and ⚠CAUTION (for storage, operating, rating, soldering, mounting and handling) in this catalog to prevent smoking and/or burning, etc.  
 • This catalog has only typical specifications. Therefore, please approve our product specifications or transact the approval sheet for product specifications before ordering.

# BLM18T Series 0603/1608 (inch/mm)



Thin 0603 size for general signal lines.

Chip Ferrite Bead  
0603/1608 (inch/mm)

Chip EMIFIL®

Chip Common Mode Choke Coil

Block Type EMIFIL®

Microwave Absorber



### ■ Dimensions

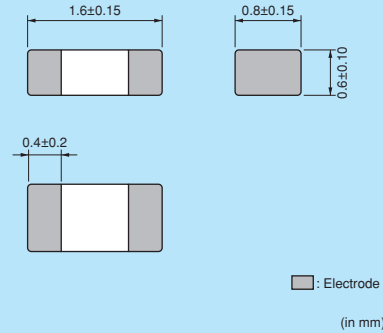

### ■ Equivalent Circuit

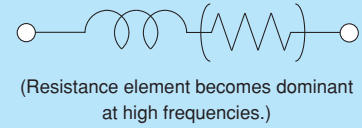

### ■ Packaging

Code	Packaging	Minimum Quantity
D	180mm Reel Paper Tape	10000
B	Bulk (Bag)	1000

Refer to pages from p.100 to p.103 for mounting information.

### ■ Rated Value (□: packaging code)

Part Number	Impedance (at 100MHz/20°C)	Rated Current	DC Resistance	Operating Temperature Range
BLM18TG121TN1□	120ohm $\pm 25\%$	200mA	0.25ohm max.	-55°C to +125°C
BLM18TG221TN1□	220ohm $\pm 25\%$	200mA	0.30ohm max.	-55°C to +125°C
BLM18TG601TN1□	600ohm $\pm 25\%$	200mA	0.45ohm max.	-55°C to +125°C
BLM18TG102TN1□	1000ohm $\pm 25\%$	100mA	0.60ohm max.	-55°C to +125°C

Number of Circuits: 1

### ■ Impedance-Frequency Characteristics

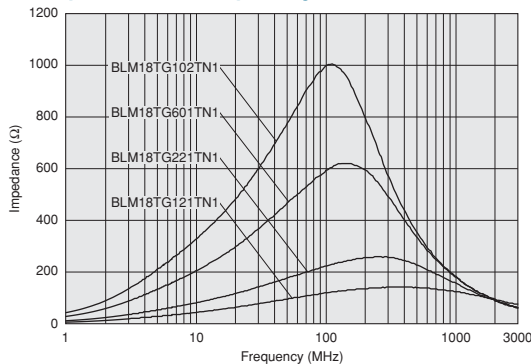

### ■ Impedance-Frequency Characteristics

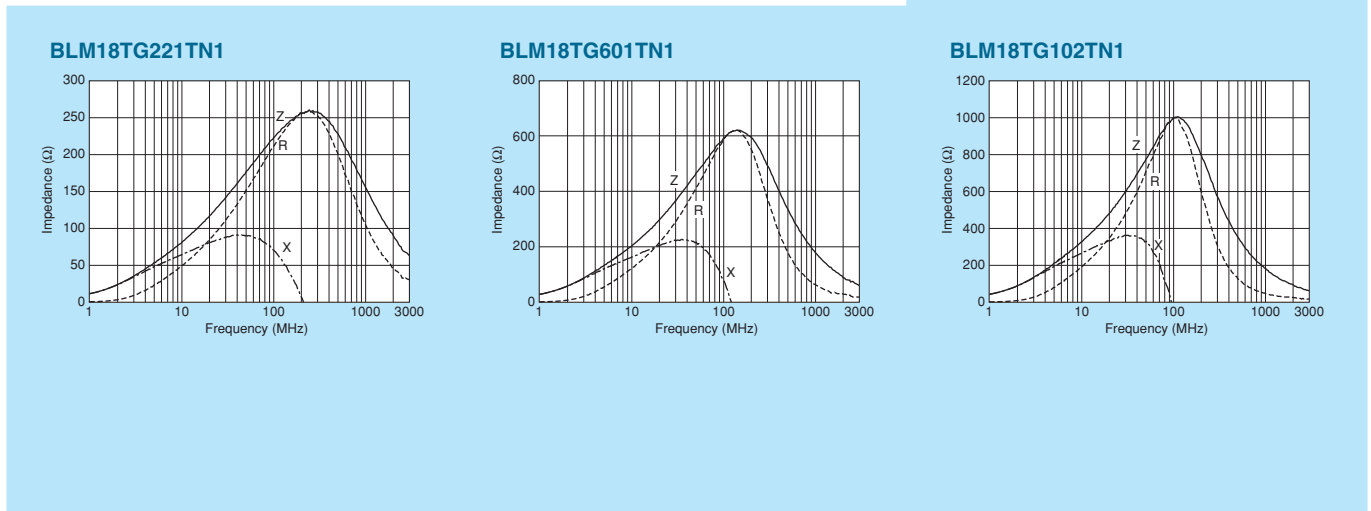
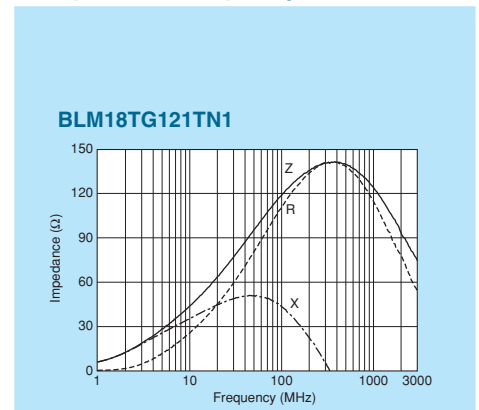

△Note • Please read rating and △CAUTION (for storage, operating, rating, soldering, mounting and handling) in this catalog to prevent smoking and/or burning, etc.  
 • This catalog has only typical specifications. Therefore, please approve our product specifications or transact the approval sheet for product specifications before ordering.



# BLM18R Series 0603/1608 (inch/mm)



For digital I/F. Reduces the distortion of waveform created by resonance.



### ■ Dimensions

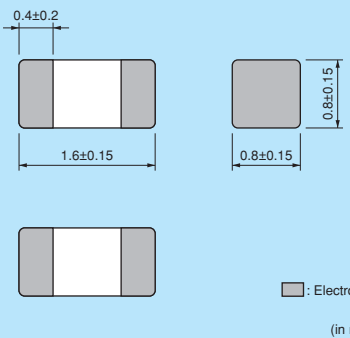

(in mm)

### ■ Equivalent Circuit



(Resistance element becomes dominant at high frequencies.)

### ■ Packaging

Code	Packaging	Minimum Quantity
D	180mm Reel Paper Tape	4000
J	330mm Reel Paper Tape	10000
B	Bulk(Bag)	1000

Refer to pages from p.100 to p.103 for mounting information.

### ■ Rated Value (□: packaging code)

Part Number	Impedance (at 100MHz/20°C)	Rated Current	DC Resistance	Operating Temperature Range
BLM18RK121SN1□	120ohm ±25%	200mA	0.25ohm max.	-55°C to +125°C
BLM18RK221SN1□	220ohm ±25%	200mA	0.30ohm max.	-55°C to +125°C
BLM18RK471SN1□	470ohm ±25%	200mA	0.50ohm max.	-55°C to +125°C
BLM18RK601SN1□	600ohm ±25%	200mA	0.60ohm max.	-55°C to +125°C
BLM18RK102SN1□	1000ohm ±25%	200mA	0.80ohm max.	-55°C to +125°C

Number of Circuits: 1

### ■ Impedance-Frequency Characteristics

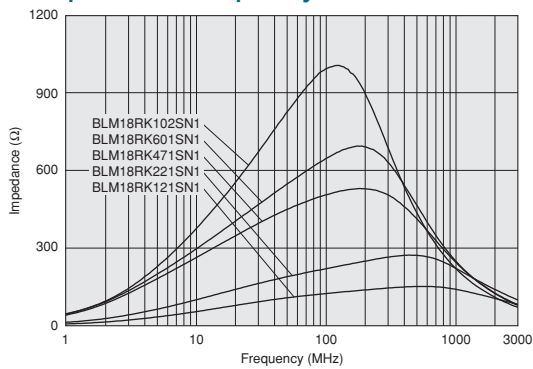

### ■ Impedance-Frequency Characteristics

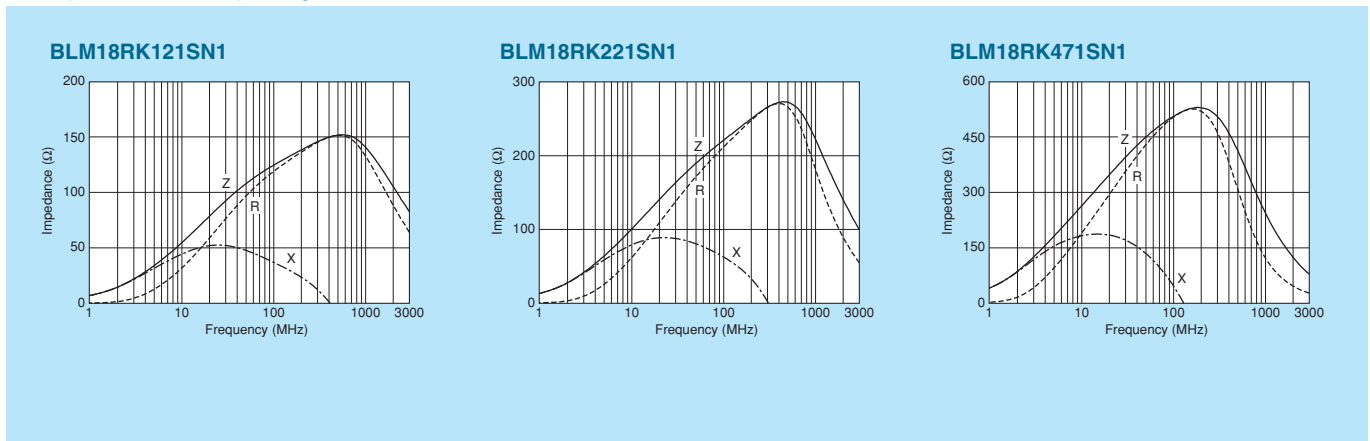

Continued on the following page.

⚠Note • Please read rating and ⚠CAUTION (for storage, operating, rating, soldering, mounting and handling) in this catalog to prevent smoking and/or burning, etc.  
 • This catalog has only typical specifications. Therefore, please approve our product specifications or transact the approval sheet for product specifications before ordering.

■ Impedance-Frequency Characteristics

Chip Ferrite Bead  
 0603/1608 (inch/mm)

Chip EMIFIL®

Chip Common Mode Choke Coil

Block Type EMIFIL®

Microwave Absorber

BLM18RK601SN1

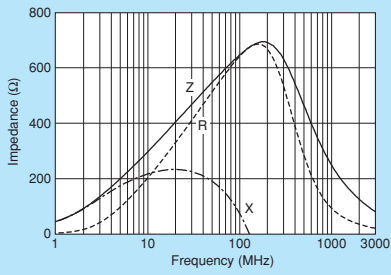

BLM18RK102SN1

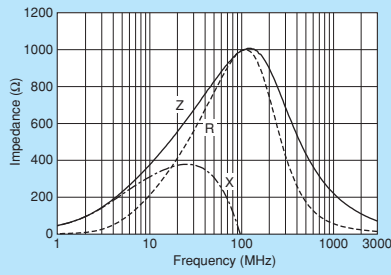

⚠Note • Please read rating and ⚠CAUTION (for storage, operating, rating, soldering, mounting and handling) in this catalog to prevent smoking and/or burning, etc.  
 • This catalog has only typical specifications. Therefore, please approve our product specifications or transact the approval sheet for product specifications before ordering.

## Waveform Distortion Suppressing Performance of BLM□□R Series

### Measuring Circuits

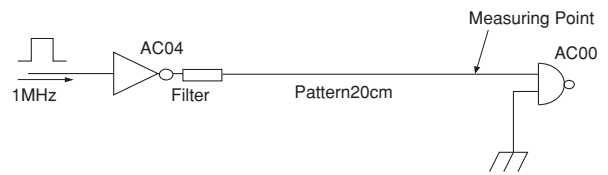

Type of Filter	EMI Suppression Effect / Description		
Initial (No filter)	<p>Signal waveform (100nsec/div, 2V/div)</p>	<p>Expand (10nsec/div, 2V/div)</p>	<p>Spectrum</p>
	<p>Ringing is caused on the signal waveform. Such ringing contains several hundred MHz harmonic components and generates noise.</p>		
	Resistor (47Ω) is used	<p>Signal waveform (100nsec/div, 2V/div)</p>	<p>Expand (10nsec/div, 2V/div)</p>
<p>Comparing initial waveform, ringing is suppressed a little. However, high level waveform distortion still remains.</p>			
BLM18RK221SN1 (220Ω at 100MHz) is used		<p>Signal waveform (100nsec/div, 2V/div)</p>	<p>Expand (10nsec/div, 2V/div)</p>
	<p>BLM18R has excellent performance for noise suppression and waveform distortion suppression. BLM18R suppresses drastically not only the spectrum level in more than 100MHz range but waveform distortion.</p>		

△Note • Please read rating and △CAUTION (for storage, operating, rating, soldering, mounting and handling) in this catalog to prevent smoking and/or burning, etc.  
• This catalog has only typical specifications. Therefore, please approve our product specifications or transact the approval sheet for product specifications before ordering.

# BLM21P Series 0805/2012 (inch/mm)



## 0805 size for power lines.

\*Please refer to the products designed for both power lines and signal lines. \*Please refer to BLM18K for downsizing.

Chip Ferrite Bead  
0805/2012 (inch/mm)



### ■ Dimensions

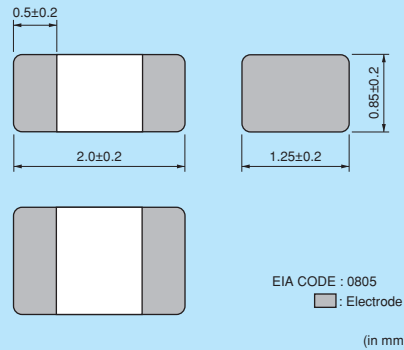

### ■ Equivalent Circuit

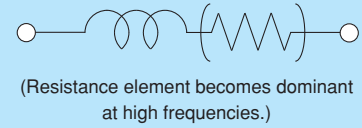

### ■ Packaging

Code	Packaging	Minimum Quantity
D	180mm Reel Paper Tape	4000
J	330mm Reel Paper Tape	10000
B	Bulk(Bag)	1000

Refer to pages from p.100 to p.103 for mounting information.

### ■ Rated Value (□: packaging code)

Part Number	Impedance (at 100MHz/20°C)	Rated Current	DC Resistance	Operating Temperature Range	Kit	Current
BLM21PG220SN1□	22ohm ±25%	6000mA	0.009ohm max.	-55°C to +125°C	Kit	≥3A
BLM21PG300SN1□	30ohm (Typ.)	4000mA	0.014ohm max.	-55°C to +125°C	Kit	≥3A
BLM21PG600SN1□	60ohm ±25%	3500mA	0.02ohm max.	-55°C to +125°C	Kit	≥3A
BLM21PG121SN1□	120ohm ±25%	3000mA	0.03ohm max.	-55°C to +125°C	Kit	≥3A
BLM21PG221SN1□	220ohm ±25%	2000mA	0.045ohm max.	-55°C to +125°C	Kit	≥1A
BLM21PG331SN1□	330ohm ±25%	1500mA	0.07ohm max.	-55°C to +125°C	Kit	≥1A

Number of Circuits: 1

### ■ Impedance-Frequency Characteristics

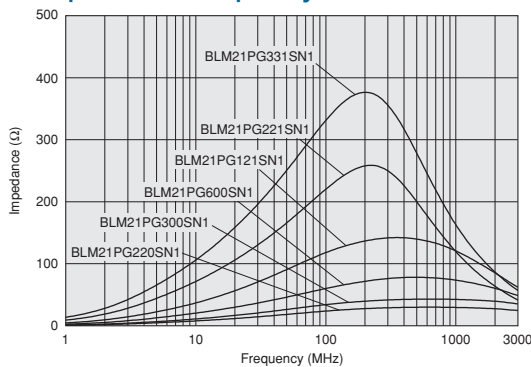

### ■ Notice (Rating)

In operating temperature exceeding +85°C, derating of current is necessary for BLM21PG series.

Please apply the derating curve shown in chart according to the operating temperature.

Derating of Rated Current

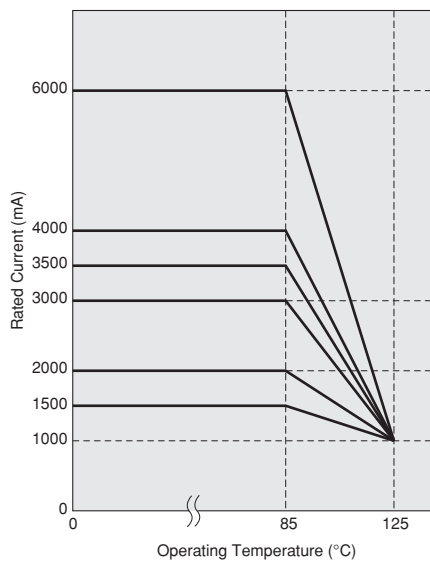

Continued on the following page.

⚠Note • Please read rating and ⚠CAUTION (for storage, operating, rating, soldering, mounting and handling) in this catalog to prevent smoking and/or burning, etc.  
 • This catalog has only typical specifications. Therefore, please approve our product specifications or transact the approval sheet for product specifications before ordering.

Chip EMIFIL®

Chip Common Mode Choke Coil

Block Type EMIFIL®

Microwave Absorber

Impedance-Frequency Characteristics

BLM21PG220SN1

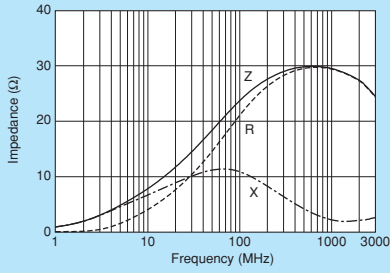

BLM21PG300SN1

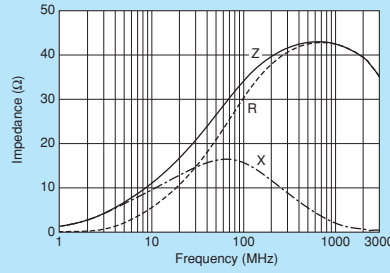

BLM21PG600SN1

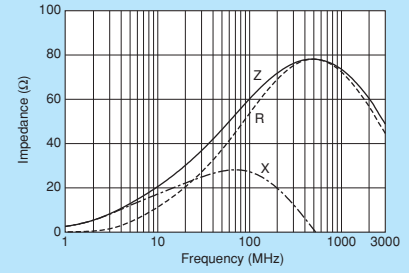

BLM21PG121SN1

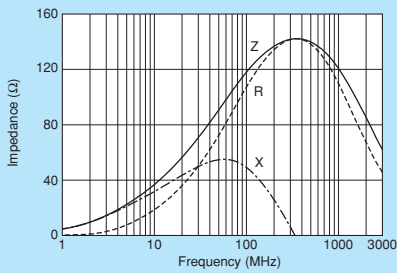

BLM21PG221SN1

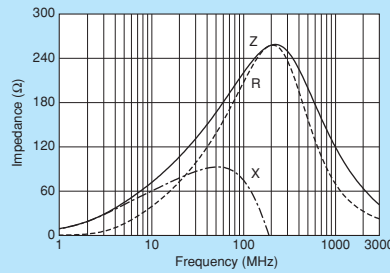

BLM21PG331SN1

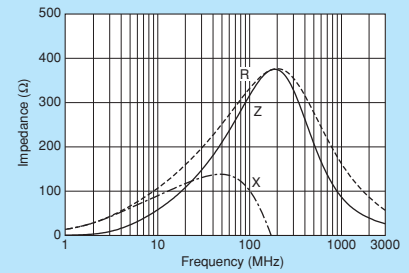

0805/2012 (inch/mm)  
 Chip Ferrite Bead

Chip EMIFIL®

Chip Common Mode Choke Coil

Block Type EMIFIL®

Microwave Absorber

⚠Note • Please read rating and ⚠CAUTION (for storage, operating, rating, soldering, mounting and handling) in this catalog to prevent smoking and/or burning, etc.  
 • This catalog has only typical specifications. Therefore, please approve our product specifications or transact the approval sheet for product specifications before ordering.

# BLM21A Series 0805/2012 (inch/mm)



0805 size for general signal lines.

Chip Ferrite Bead  
0805/2012 (inch/mm)



### ■ Dimensions

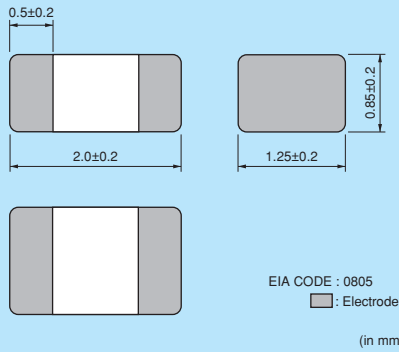

### ■ Equivalent Circuit

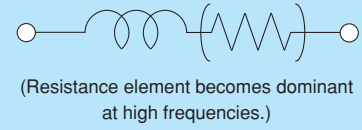

### ■ Packaging

Code	Packaging	Minimum Quantity
D	180mm Reel Paper Tape	4000
J	330mm Reel Paper Tape	10000
B	Bulk(Bag)	1000

Refer to pages from p.100 to p.103 for mounting information.

### ■ Rated Value (□: packaging code)

Part Number	Impedance (at 100MHz/20°C)	Rated Current	DC Resistance	Operating Temperature Range	
BLM21AG121SN1□	120ohm ±25%	800mA	0.10ohm max.	-55°C to +125°C	Kit
BLM21AG151SN1□	150ohm ±25%	800mA	0.10ohm max.	-55°C to +125°C	Kit
BLM21AG221SN1□	220ohm ±25%	800mA	0.13ohm max.	-55°C to +125°C	Kit
BLM21AG331SN1□	330ohm ±25%	700mA	0.16ohm max.	-55°C to +125°C	Kit
BLM21AG471SN1□	470ohm ±25%	700mA	0.19ohm max.	-55°C to +125°C	Kit
BLM21AG601SN1□	600ohm ±25%	600mA	0.21ohm max.	-55°C to +125°C	Kit
BLM21AG102SN1□	1000ohm ±25%	500mA	0.28ohm max.	-55°C to +125°C	Kit

Number of Circuits: 1

### ■ Impedance-Frequency Characteristics

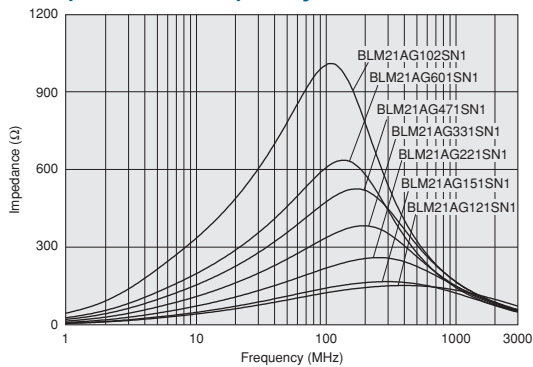

### ■ Impedance-Frequency Characteristics

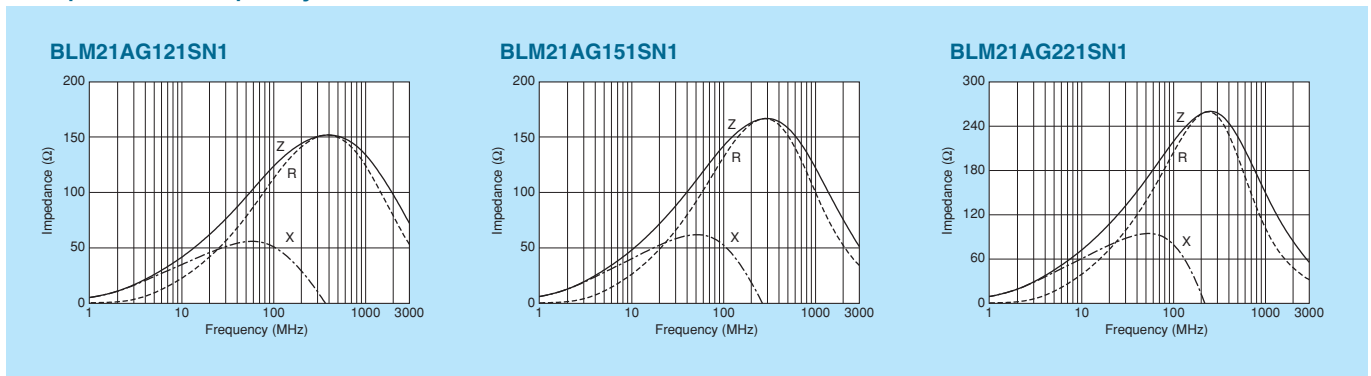

Continued on the following page.

△Note • Please read rating and △CAUTION (for storage, operating, rating, soldering, mounting and handling) in this catalog to prevent smoking and/or burning, etc.  
• This catalog has only typical specifications. Therefore, please approve our product specifications or transact the approval sheet for product specifications before ordering.

Chip EMIFIL®

Chip Common Mode Choke Coil

Block Type EMIFIL®

Microwave Absorber

Impedance-Frequency Characteristics

BLM21AG331SN1

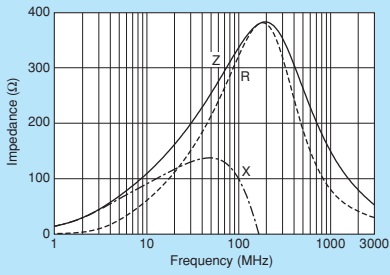

BLM21AG471SN1

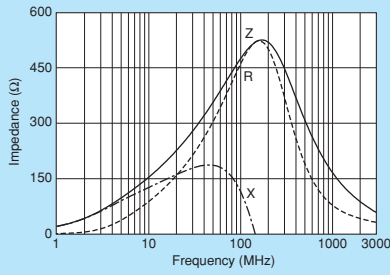

BLM21AG601SN1

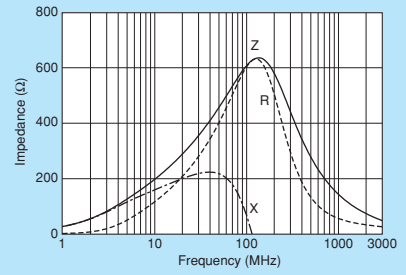

BLM21AG102SN1

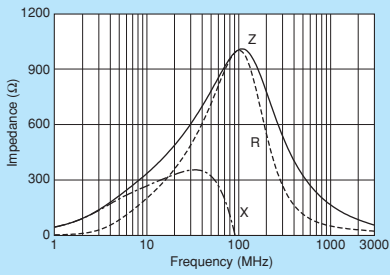

0805/2012 (inch/mm)  
 Chip Ferrite Bead

Chip EMIFIL®

Chip Common Mode Choke Coil

Block Type EMIFIL®

Microwave Absorber

⚠Note • Please read rating and ⚠CAUTION (for storage, operating, rating, soldering, mounting and handling) in this catalog to prevent smoking and/or burning, etc.  
 • This catalog has only typical specifications. Therefore, please approve our product specifications or transact the approval sheet for product specifications before ordering.

# BLM21B Series 0805/2012 (inch/mm)



0805 size for high speed signal lines.

Chip Ferrite Bead  
0805/2012 (inch/mm)

Chip EMIFIL®

Chip Common Mode Choke Coil

Block Type EMIFIL®

Microwave Absorber



### ■ Dimensions

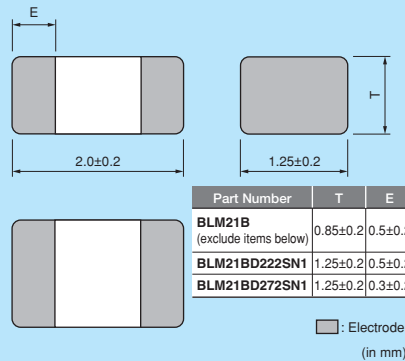

### ■ Equivalent Circuit

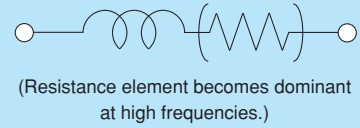

### ■ Packaging

• All except for BLM21BD222SN1/21BD272SN1

Code	Packaging	Minimum Quantity
D	180mm Reel Paper Tape	4000
J	330mm Reel Paper Tape	10000
B	Bulk(Bag)	1000

• BLM21BD222SN1/21BD272SN1 only

Code	Packaging	Minimum Quantity
L	180mm Reel Plastic Tape	3000
K	330mm Reel Plastic Tape	10000
B	Bulk(Bag)	1000

Refer to pages from p.100 to p.103 for mounting information.

### ■ Rated Value (□: packaging code)

Part Number	Impedance (at 100MHz/20°C)	Rated Current	DC Resistance	Operating Temperature Range	
BLM21BD121SN1□	120ohm ±25%	200mA	0.25ohm max.	-55°C to +125°C	Kit
BLM21BD151SN1□	150ohm ±25%	200mA	0.25ohm max.	-55°C to +125°C	
BLM21BD221SN1□	220ohm ±25%	200mA	0.25ohm max.	-55°C to +125°C	Kit
BLM21BD331SN1□	330ohm ±25%	200mA	0.30ohm max.	-55°C to +125°C	
BLM21BD421SN1□	420ohm ±25%	200mA	0.30ohm max.	-55°C to +125°C	Kit
BLM21BD471SN1□	470ohm ±25%	200mA	0.35ohm max.	-55°C to +125°C	Kit
BLM21BD601SN1□	600ohm ±25%	200mA	0.35ohm max.	-55°C to +125°C	Kit
BLM21BD751SN1□	750ohm ±25%	200mA	0.40ohm max.	-55°C to +125°C	
BLM21BD102SN1□	1000ohm ±25%	200mA	0.40ohm max.	-55°C to +125°C	Kit
BLM21BD152SN1□	1500ohm ±25%	200mA	0.45ohm max.	-55°C to +125°C	Kit
BLM21BD182SN1□	1800ohm ±25%	200mA	0.50ohm max.	-55°C to +125°C	Kit
BLM21BD222TN1□	2200ohm ±25%	200mA	0.60ohm max.	-55°C to +125°C	Kit
BLM21BD222SN1□	2250ohm (Typ.)	200mA	0.60ohm max.	-55°C to +125°C	Kit
BLM21BD272SN1□	2700ohm ±25%	200mA	0.80ohm max.	-55°C to +125°C	Kit
BLM21BB050SN1□	5ohm ±25%	1000mA	0.02ohm max.	-55°C to +125°C	Kit
BLM21BB600SN1□	60ohm ±25%	800mA	0.13ohm max.	-55°C to +125°C	Kit
BLM21BB750SN1□	75ohm ±25%	700mA	0.16ohm max.	-55°C to +125°C	Kit
BLM21BB121SN1□	120ohm ±25%	600mA	0.19ohm max.	-55°C to +125°C	Kit
BLM21BB151SN1□	150ohm ±25%	600mA	0.21ohm max.	-55°C to +125°C	
BLM21BB201SN1□	200ohm ±25%	500mA	0.26ohm max.	-55°C to +125°C	
BLM21BB221SN1□	220ohm ±25%	500mA	0.26ohm max.	-55°C to +125°C	Kit
BLM21BB331SN1□	330ohm ±25%	400mA	0.33ohm max.	-55°C to +125°C	Kit
BLM21BB471SN1□	470ohm ±25%	400mA	0.40ohm max.	-55°C to +125°C	Kit

Number of Circuits: 1

Continued on the following page. ↗

△Note • Please read rating and △CAUTION (for storage, operating, rating, soldering, mounting and handling) in this catalog to prevent smoking and/or burning, etc.  
• This catalog has only typical specifications. Therefore, please approve our product specifications or transact the approval sheet for product specifications before ordering.



Impedance-Frequency Characteristics

BLM21BD Series

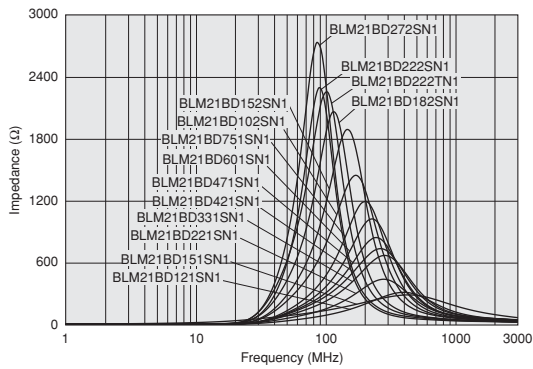

BLM21BB Series

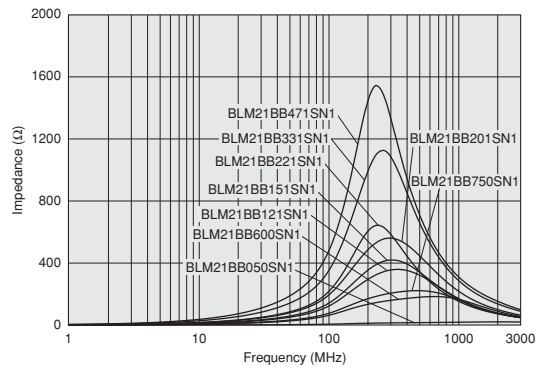

Impedance-Frequency Characteristics

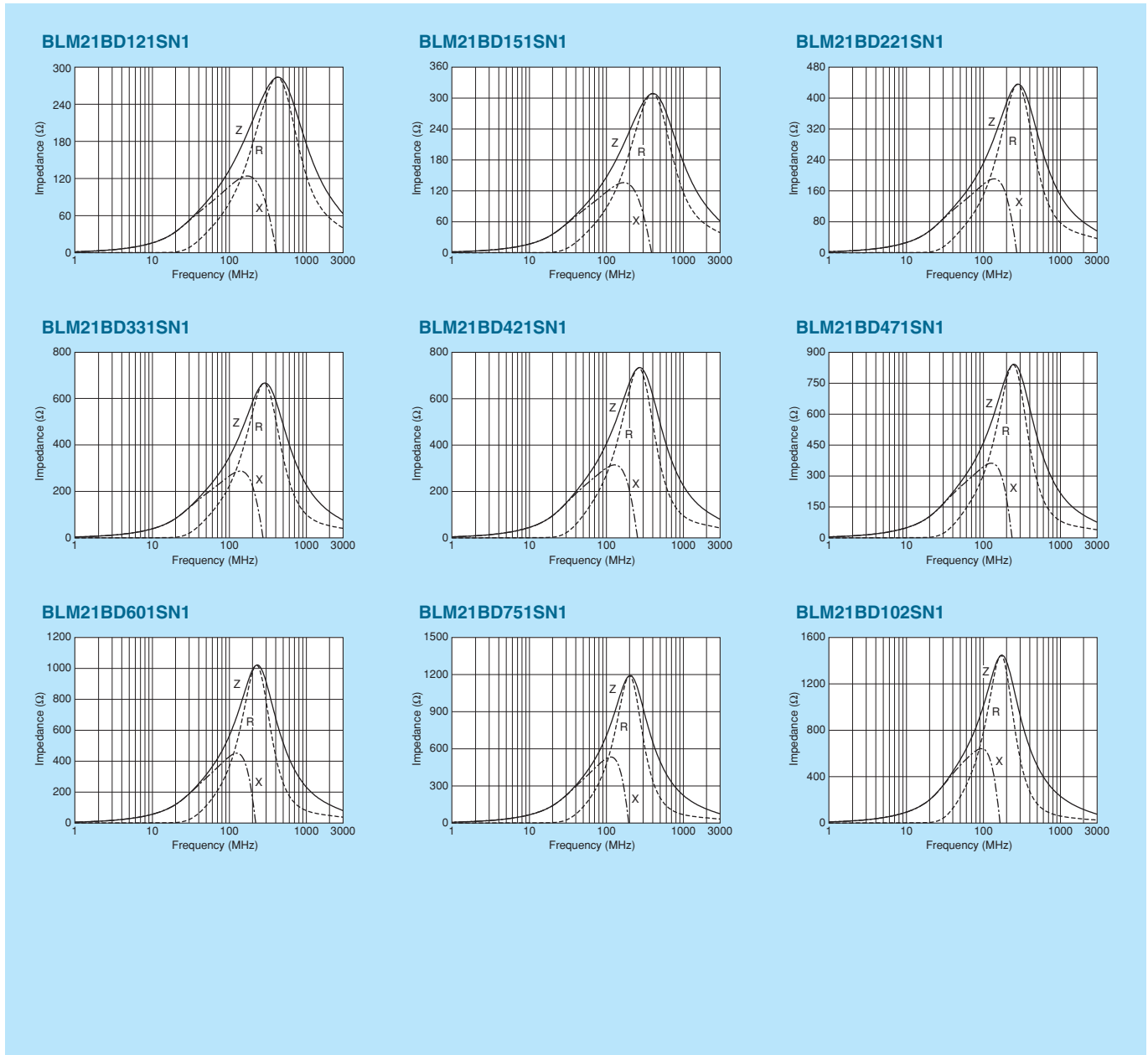

Continued on the following page.

**Note** • Please read rating and **CAUTION** (for storage, operating, rating, soldering, mounting and handling) in this catalog to prevent smoking and/or burning, etc.  
 • This catalog has only typical specifications. Therefore, please approve our product specifications or transact the approval sheet for product specifications before ordering.

Impedance-Frequency Characteristics

Chip Ferrite Bead  
 0805/2012 (inch/mm)

Chip EMIFIL®

Chip Common Mode Choke Coil

Block Type EMIFIL®

Microwave Absorber

BLM21BD152SN1

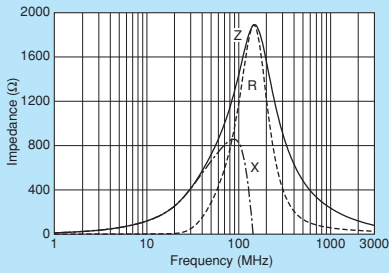

BLM21BD182SN1

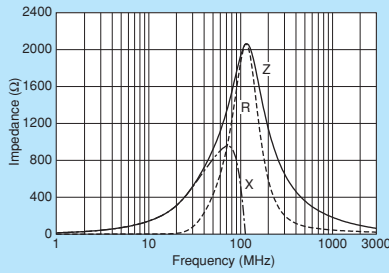

BLM21BD222TN1

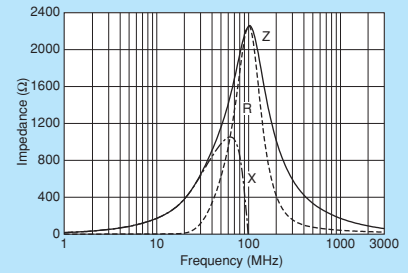

BLM21BD222SN1

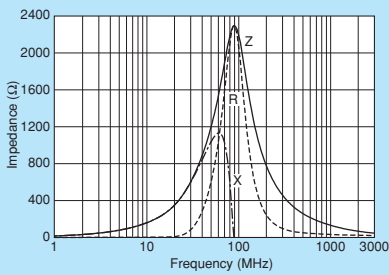

BLM21BD272SN1

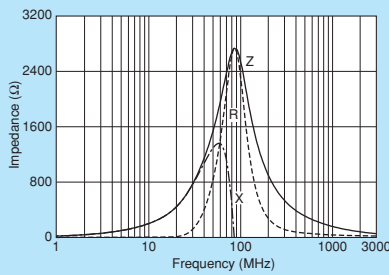

BLM21BB050SN1

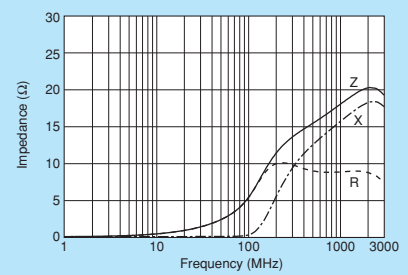

BLM21BB600SN1

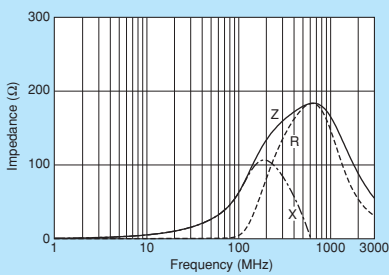

BLM21BB750SN1

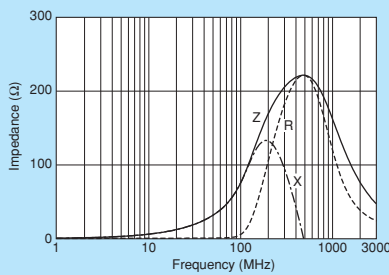

BLM21BB121SN1

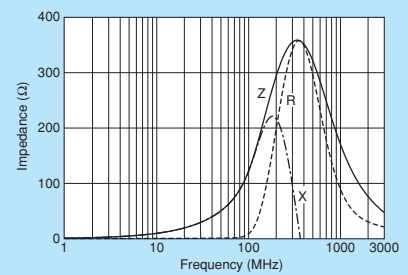

BLM21BB151SN1

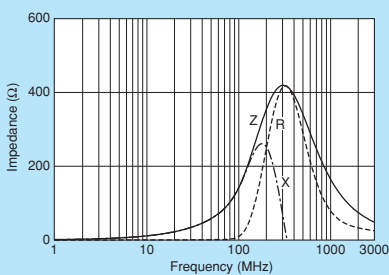

BLM21BB201SN1

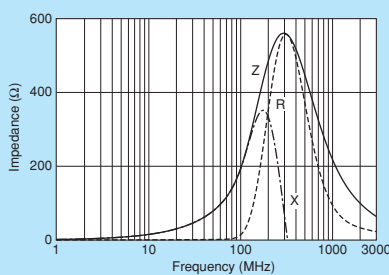

BLM21BB221SN1

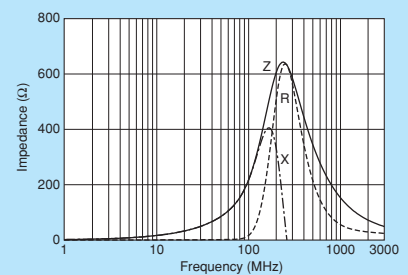

BLM21BB331SN1

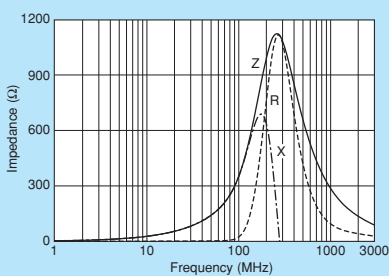

BLM21BB471SN1

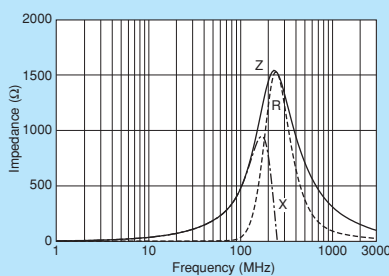

△Note • Please read rating and △CAUTION (for storage, operating, rating, soldering, mounting and handling) in this catalog to prevent smoking and/or burning, etc.  
 • This catalog has only typical specifications. Therefore, please approve our product specifications or transact the approval sheet for product specifications before ordering.

# BLM21R Series 0805/2012 (inch/mm)



For digital I/F. Reduces the distortion of waveform created by resonance.



### ■ Dimensions

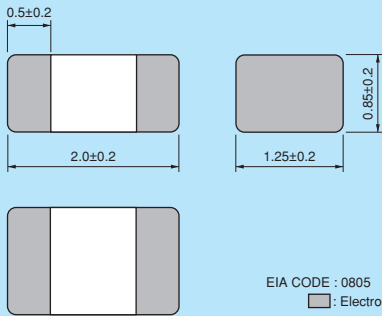

EIA CODE : 0805  
 Electrode  
 (in mm)

### ■ Equivalent Circuit



(Resistance element becomes dominant at high frequencies.)

### ■ Packaging

Code	Packaging	Minimum Quantity
D	180mm Reel Paper Tape	4000
J	330mm Reel Paper Tape	10000
B	Bulk(Bag)	1000

Refer to pages from p.100 to p.103 for mounting information.

### ■ Rated Value (□: packaging code)

Part Number	Impedance (at 100MHz/20°C)	Rated Current	DC Resistance	Operating Temperature Range
BLM21RK121SN1□	120ohm ±25%	200mA	0.15ohm max.	-55°C to +125°C
BLM21RK221SN1□	220ohm ±25%	200mA	0.20ohm max.	-55°C to +125°C
BLM21RK471SN1□	470ohm ±25%	200mA	0.25ohm max.	-55°C to +125°C
BLM21RK601SN1□	600ohm ±25%	200mA	0.30ohm max.	-55°C to +125°C
BLM21RK102SN1□	1000ohm ±25%	200mA	0.50ohm max.	-55°C to +125°C

Number of Circuits: 1

### ■ Impedance-Frequency Characteristics

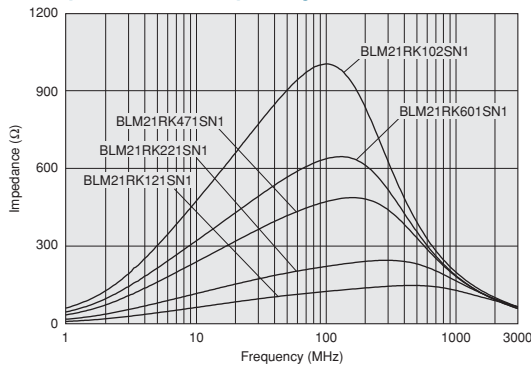

### ■ Impedance-Frequency Characteristics

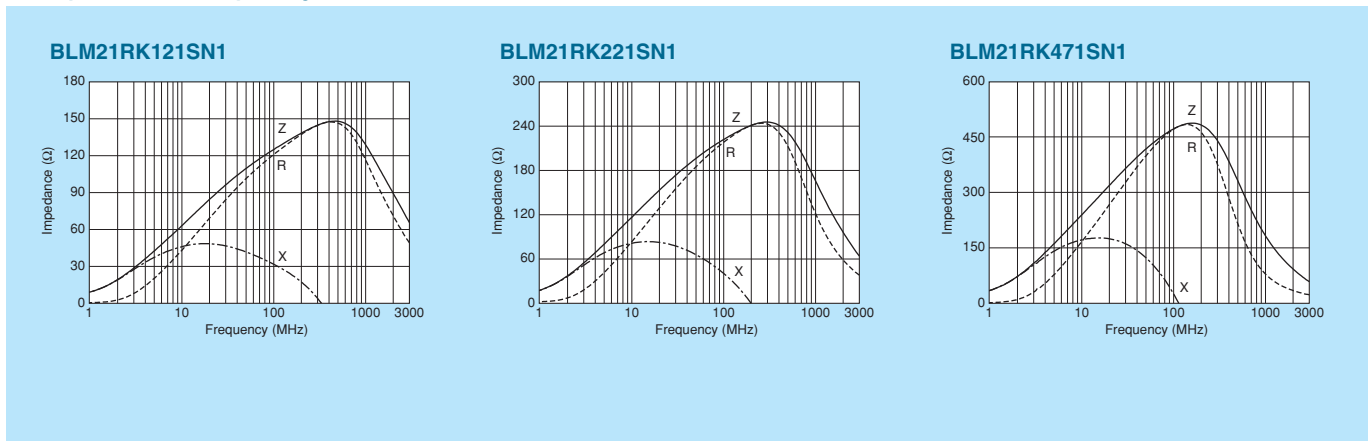

Continued on the following page.

⚠Note • Please read rating and ⚠CAUTION (for storage, operating, rating, soldering, mounting and handling) in this catalog to prevent smoking and/or burning, etc.  
 • This catalog has only typical specifications. Therefore, please approve our product specifications or transact the approval sheet for product specifications before ordering.

■ Impedance-Frequency Characteristics

BLM21RK601SN1

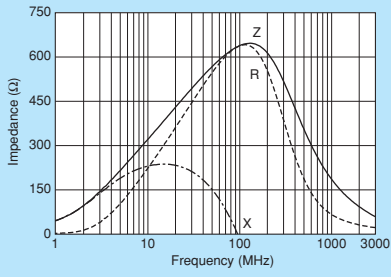

BLM21RK102SN1

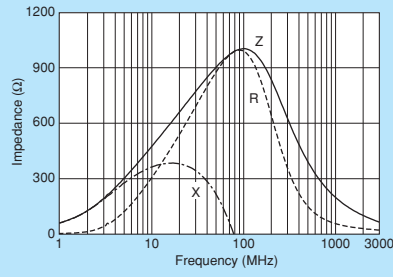

△Note • Please read rating and △CAUTION (for storage, operating, rating, soldering, mounting and handling) in this catalog to prevent smoking and/or burning, etc.  
 • This catalog has only typical specifications. Therefore, please approve our product specifications or transact the approval sheet for product specifications before ordering.

Chip Ferrite Bead 0805/2012 (inch/mm)  
 Chip EMIFIL®  
 Chip Common Mode Choke Coil  
 Block Type EMIFIL®  
 Microwave Absorber

# BLM31P Series 1206/3216 (inch/mm)



## 1206 size for power lines.

\*Please refer to the products designed for both power lines and signal lines.



### ■ Dimensions

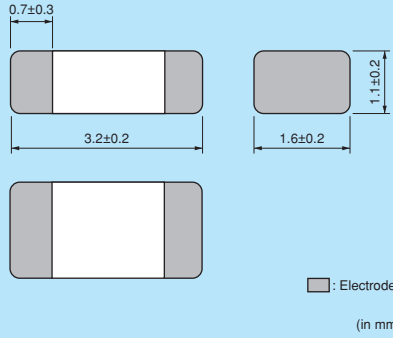

(in mm)

### ■ Equivalent Circuit



(Resistance element becomes dominant at high frequencies.)

### ■ Packaging

Code	Packaging	Minimum Quantity
L	180mm Reel Embossed Tape	3000
K	330mm Reel Embossed Tape	10000
B	Bulk(Bag)	1000

Refer to pages from p.100 to p.103 for mounting information.

### ■ Rated Value (□: packaging code)

Part Number	Impedance (at 100MHz/20°C)	Rated Current	DC Resistance	Operating Temperature Range	Kit	Current
BLM31PG330SN1□	33ohm ±25%	6000mA	0.009ohm max.	-55°C to +125°C	Kit	≥3A
BLM31PG500SN1□	50ohm (Typ.)	3500mA	0.015ohm max.	-55°C to +125°C	Kit	≥3A
BLM31PG121SN1□	120ohm ±25%	3500mA	0.02ohm max.	-55°C to +125°C	Kit	≥3A
BLM31PG391SN1□	390ohm ±25%	2000mA	0.05ohm max.	-55°C to +125°C	Kit	≥1A
BLM31PG601SN1□	600ohm ±25%	1500mA	0.08ohm max.	-55°C to +125°C	Kit	≥1A

Number of Circuits: 1

### ■ Impedance-Frequency Characteristics

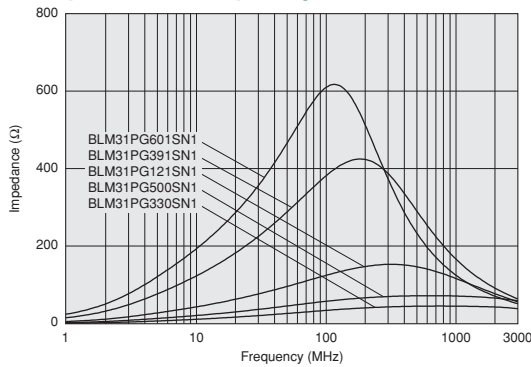

### ■ Notice (Rating)

In operating temperature exceeding +85°C, derating of current is necessary for BLM31PG series.

Please apply the derating curve shown in chart according to the operating temperature.

Derating of Rated Current

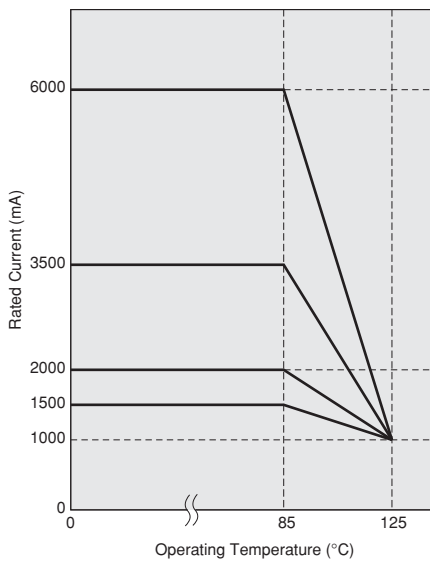

Continued on the following page.

⚠Note • Please read rating and ⚠CAUTION (for storage, operating, rating, soldering, mounting and handling) in this catalog to prevent smoking and/or burning, etc.  
 • This catalog has only typical specifications. Therefore, please approve our product specifications or transact the approval sheet for product specifications before ordering.

Impedance-Frequency Characteristics

BLM31PG330SN1

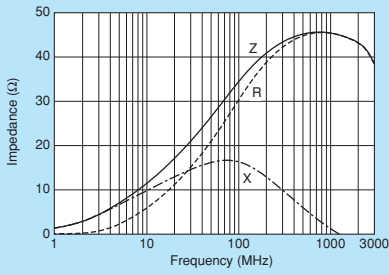

BLM31PG500SN1

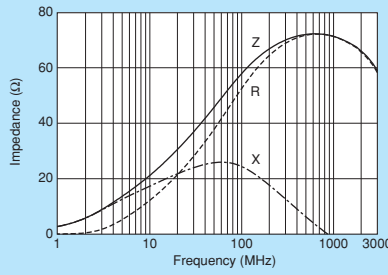

BLM31PG121SN1

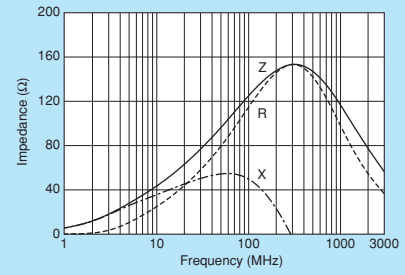

BLM31PG391SN1

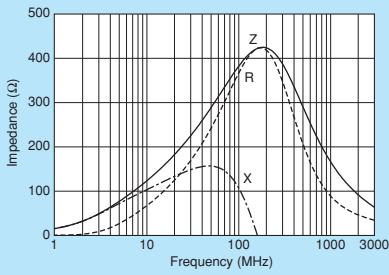

BLM31PG601SN1

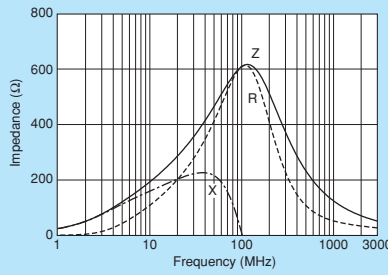

⚠Note • Please read rating and ⚠CAUTION (for storage, operating, rating, soldering, mounting and handling) in this catalog to prevent smoking and/or burning, etc.  
 • This catalog has only typical specifications. Therefore, please approve our product specifications or transact the approval sheet for product specifications before ordering.

Chip Ferrite Bead  
 1206/3216 (inch/mm)

Chip EMIFIL®

Chip Common Mode Choke Coil

Block Type EMIFIL®

Microwave Absorber

# BLM41P Series 1806/4516 (inch/mm)



## 1806 size for power lines.

\*Please refer to the products designed for both power lines and signal lines.



### ■ Dimensions

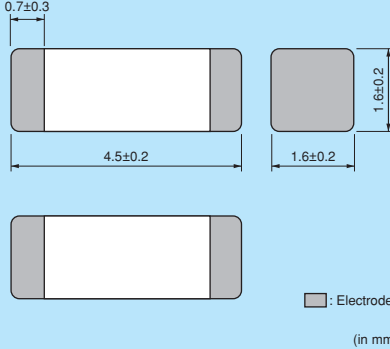

(in mm)

### ■ Equivalent Circuit



(Resistance element becomes dominant at high frequencies.)

### ■ Packaging

Code	Packaging	Minimum Quantity
L	180mm Reel Embossed Tape	2500
K	330mm Reel Embossed Tape	8000
B	Bulk(Bag)	1000

Refer to pages from p.100 to p.103 for mounting information.

### ■ Rated Value (□: packaging code)

Part Number	Impedance (at 100MHz/20°C)	Rated Current	DC Resistance	Operating Temperature Range	Kit	Current
BLM41PG600SN1□	60ohm (Typ.)	6000mA	0.009ohm max.	-55°C to +125°C	Kit	≥3A
BLM41PG750SN1□	75ohm (Typ.)	3500mA	0.015ohm max.	-55°C to +125°C	Kit	≥3A
BLM41PG181SN1□	180ohm ±25%	3500mA	0.02ohm max.	-55°C to +125°C	Kit	≥3A
BLM41PG471SN1□	470ohm ±25%	2000mA	0.05ohm max.	-55°C to +125°C	Kit	≥1A
BLM41PG102SN1□	1000ohm ±25%	1500mA	0.09ohm max.	-55°C to +125°C	Kit	≥1A

Number of Circuits: 1

### ■ Impedance-Frequency Characteristics BLM41PG Series (60ohm to 75ohm)

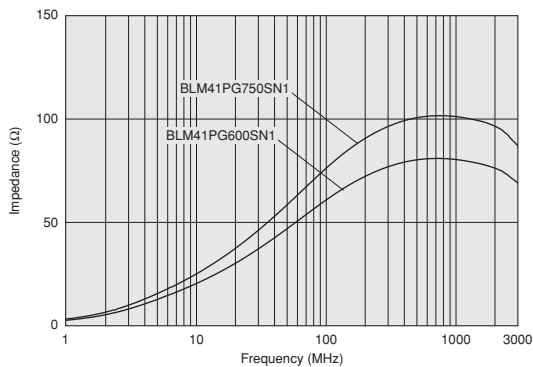

### ■ Impedance-Frequency Characteristics BLM41PG Series (180ohm to 1000ohm)

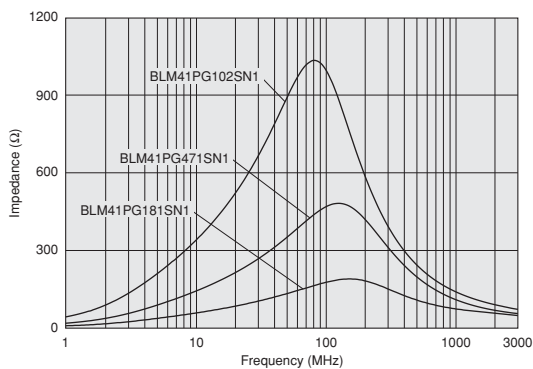

### ■ Notice (Rating)

In operating temperature exceeding +85°C, derating of current is necessary for BLM41PG series.

Please apply the derating curve shown in chart according to the operating temperature.

Derating of Rated Current

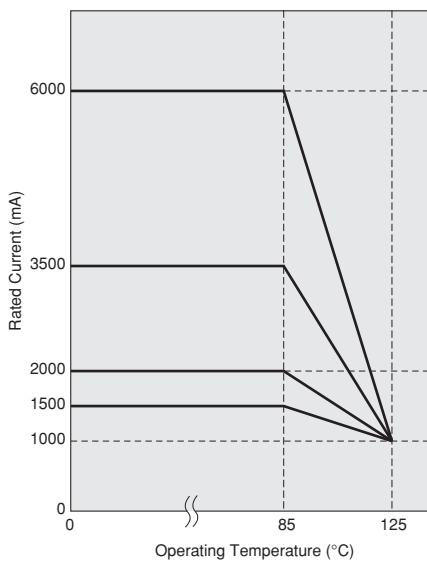

Continued on the following page.

⚠Note • Please read rating and ⚠CAUTION (for storage, operating, rating, soldering, mounting and handling) in this catalog to prevent smoking and/or burning, etc.  
• This catalog has only typical specifications. Therefore, please approve our product specifications or transact the approval sheet for product specifications before ordering.

Impedance-Frequency Characteristics

Chip Ferrite Bead  
 1806/4516 (inch/mm)

Chip EMIFIL®

Chip Common Mode Choke Coil

Block Type EMIFIL®

Microwave Absorber

BLM41PG600SN1

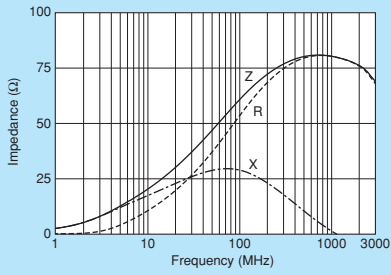

BLM41PG750SN1

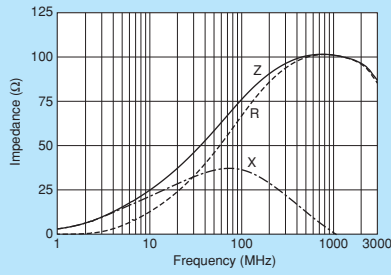

BLM41PG181SN1

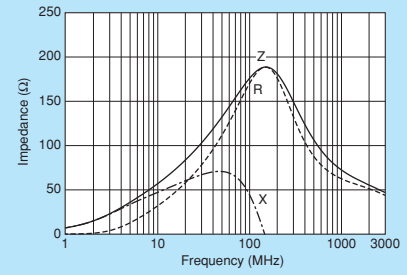

BLM41PG471SN1

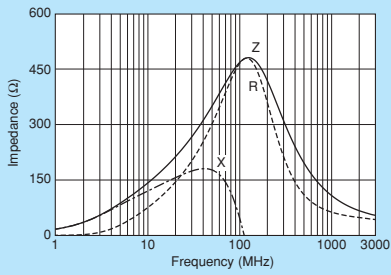

BLM41PG102SN1

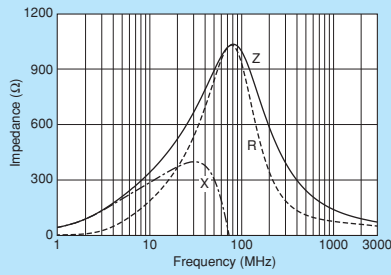

⚠Note • Please read rating and ⚠CAUTION (for storage, operating, rating, soldering, mounting and handling) in this catalog to prevent smoking and/or burning, etc.  
 • This catalog has only typical specifications. Therefore, please approve our product specifications or transact the approval sheet for product specifications before ordering.



# BLE32P Series 1210/3225 (inch/mm)



10A max., large current chip ferrite bead inductor.

### ■ Dimensions

Legend:  Electrode (in mm)

### ■ Equivalent Circuit

(Resistance element becomes dominant at high frequencies.)

### ■ Packaging

Code	Packaging	Minimum Quantity
L	180mm Reel Embossed Tape	1500
K	330mm Reel Embossed Tape	7000
B	Bulk(Bag)	1000

Refer to pages from p.100 to p.103 for mounting information.

### ■ Rated Value (□: packaging code)

Part Number	Impedance (at 100MHz/20°C)	Rated Current	DC Resistance	Operating Temperature Range	
<b>BLE32PN300SN1</b> □	30ohm ±10ohm	10000mA	1.6m ohm max.	-55°C to +125°C	New $\geq 10A$

Number of Circuits: 1

### ■ Impedance-Frequency Characteristics

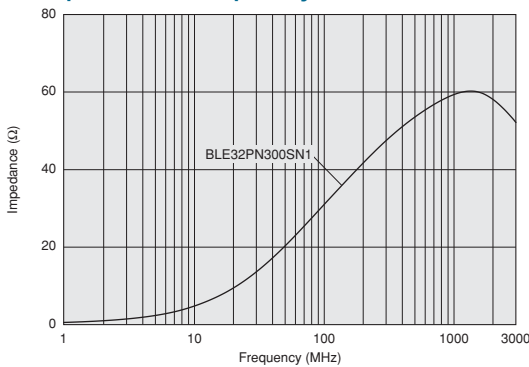

### ■ Impedance-Frequency Characteristics



⚠Note • Please read rating and ⚠CAUTION (for storage, operating, rating, soldering, mounting and handling) in this catalog to prevent smoking and/or burning, etc.  
 • This catalog has only typical specifications. Therefore, please approve our product specifications or transact the approval sheet for product specifications before ordering.

# BLA2AA/BLA2AB Series 0804/2010 (inch/mm)



4-line array, 0804 size.

Chip Ferrite Bead  
0804/2010 (inch/mm)

Chip EMIFIL®

Chip Common Mode Choke Coil

Block Type EMIFIL®

Microwave Absorber



### Dimensions

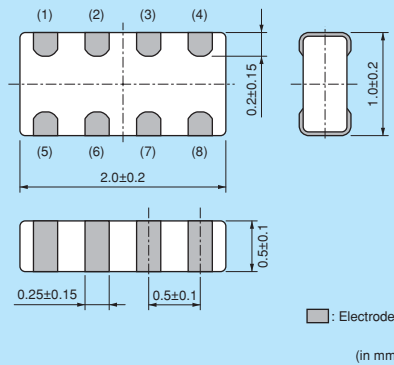

### Equivalent Circuit

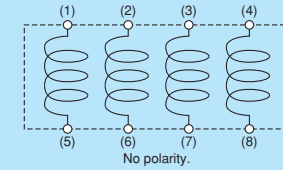

### Packaging

Code	Packaging	Minimum Quantity
D	180mm Reel Paper Tape	10000
J	330mm Reel Paper Tape	50000
B	Bulk(Bag)	1000

Refer to pages from p.100 to p.103 for mounting information.

### Rated Value (□: packaging code)

Part Number	Impedance (at 100MHz/20°C)	Rated Current	DC Resistance	Operating Temperature Range
BLA2AAG121SN4□	120ohm ±25%	100mA	0.50ohm max.	-55°C to +125°C
BLA2AAG221SN4□	220ohm ±25%	50mA	0.70ohm max.	-55°C to +125°C
BLA2AAG601SN4□	600ohm ±25%	50mA	1.10ohm max.	-55°C to +125°C
BLA2AAG102SN4□	1000ohm ±25%	50mA	1.30ohm max.	-55°C to +125°C
BLA2ABD750SN4□	75ohm ±25%	200mA	0.20ohm max.	-55°C to +125°C
BLA2ABD121SN4□	120ohm ±25%	200mA	0.35ohm max.	-55°C to +125°C
BLA2ABD221SN4□	220ohm ±25%	100mA	0.40ohm max.	-55°C to +125°C
BLA2ABD471SN4□	470ohm ±25%	100mA	0.65ohm max.	-55°C to +125°C
BLA2ABD601SN4□	600ohm ±25%	100mA	0.80ohm max.	-55°C to +125°C
BLA2ABD102SN4□	1000ohm ±25%	50mA	1.00ohm max.	-55°C to +125°C
BLA2ABB100SN4□	10ohm ±25%	200mA	0.1ohm max.	-55°C to +125°C
BLA2ABB220SN4□	22ohm ±25%	200mA	0.2ohm max.	-55°C to +125°C
BLA2ABB470SN4□	47ohm ±25%	200mA	0.35ohm max.	-55°C to +125°C
BLA2ABB121SN4□	120ohm ±25%	50mA	0.60ohm max.	-55°C to +125°C
BLA2ABB221SN4□	220ohm ±25%	50mA	0.90ohm max.	-55°C to +125°C

Number of Circuits: 4

### Impedance-Frequency Characteristics

#### BLA2AAG Series

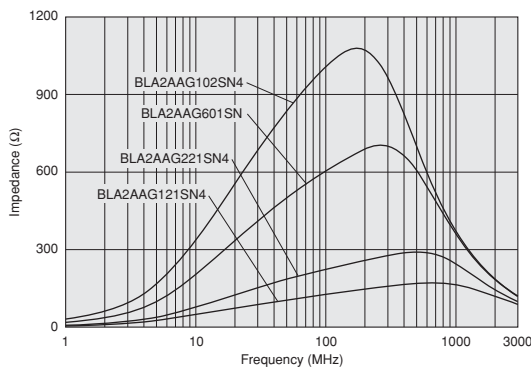

#### BLA2ABD Series

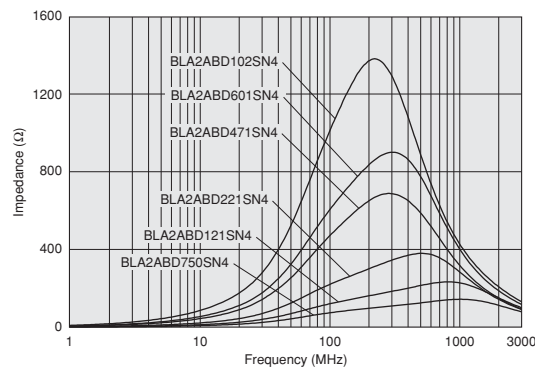

Continued on the following page. ↗

⚠ Note • Please read rating and ⚠ CAUTION (for storage, operating, rating, soldering, mounting and handling) in this catalog to prevent smoking and/or burning, etc.  
• This catalog has only typical specifications. Therefore, please approve our product specifications or transact the approval sheet for product specifications before ordering.

**Impedance-Frequency Characteristics**  
 BLA2ABB Series

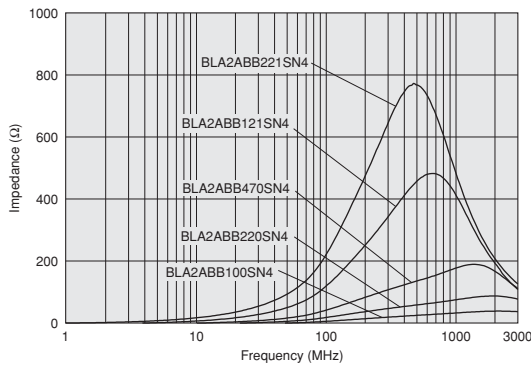

**Impedance-Frequency Characteristics**

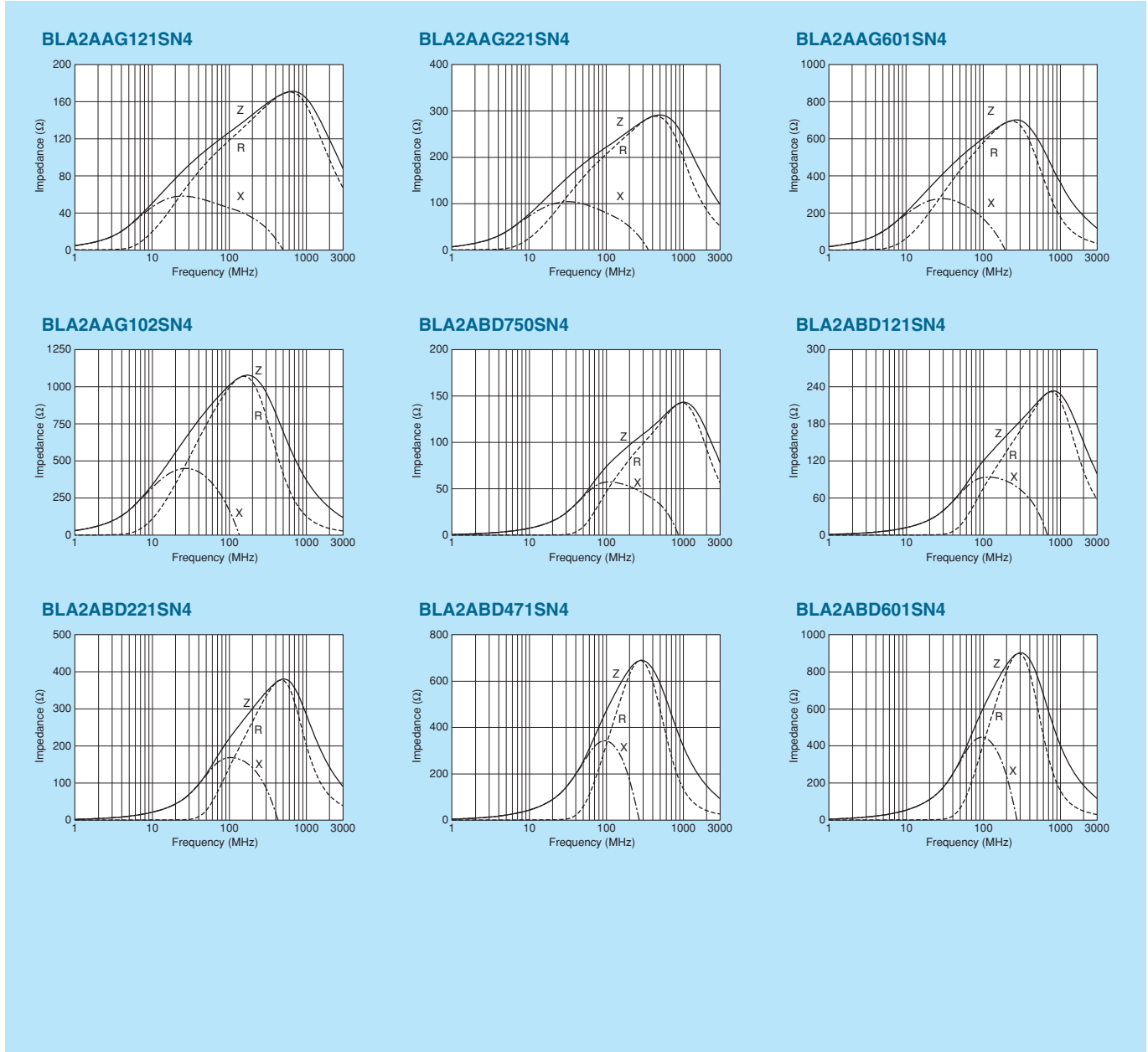

Continued on the following page.

**Note** • Please read rating and **CAUTION** (for storage, operating, rating, soldering, mounting and handling) in this catalog to prevent smoking and/or burning, etc.  
 • This catalog has only typical specifications. Therefore, please approve our product specifications or transact the approval sheet for product specifications before ordering.

Impedance-Frequency Characteristics

BLA2ABD102SN4

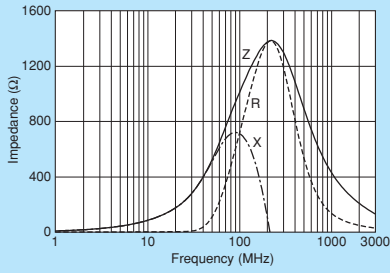

BLA2ABB100SN4

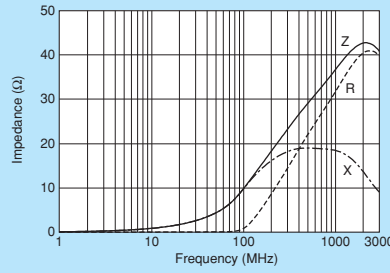

BLA2ABB220SN4

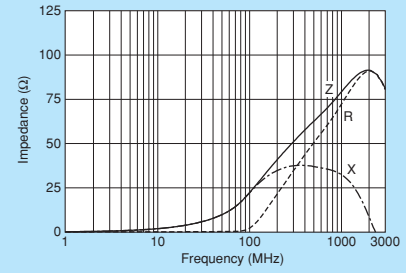

BLA2ABB470SN4

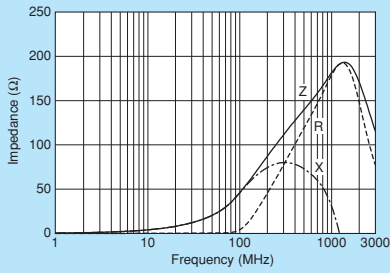

BLA2ABB121SN4

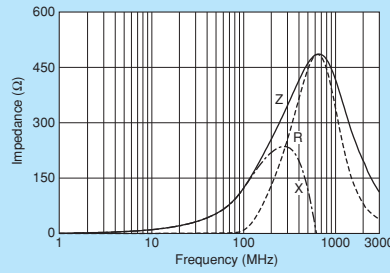

BLA2ABB221SN4

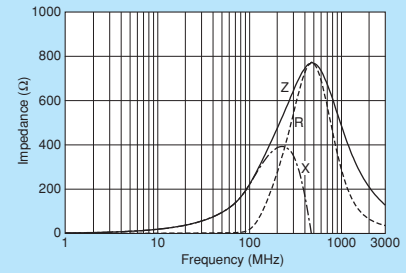

⚠Note • Please read rating and ⚠CAUTION (for storage, operating, rating, soldering, mounting and handling) in this catalog to prevent smoking and/or burning, etc.  
 • This catalog has only typical specifications. Therefore, please approve our product specifications or transact the approval sheet for product specifications before ordering.

Chip Ferrite Bead  
 0804/2010 (inch/mm)

Chip EMIFIL®

Chip Common Mode Choke Coil

Block Type EMIFIL®

Microwave Absorber

# BLA31A/BLA31B Series 1206/3216 (inch/mm)



4-line array, 1206 size.

### ■ Dimensions

Legend:  Electrode (in mm)

### ■ Equivalent Circuit

No polarity.

### ■ Packaging

Code	Packaging	Minimum Quantity
D	180mm Reel Paper Tape	4000
J	330mm Reel Paper Tape	10000
B	Bulk(Bag)	1000

Refer to pages from p.100 to p.103 for mounting information.

## ■ Rated Value (□: packaging code)

Part Number	Impedance (at 100MHz/20°C)	Rated Current	DC Resistance	Operating Temperature Range
BLA31AG300SN4□	30ohm ±25%	200mA	0.10ohm max.	-55°C to +125°C
BLA31AG600SN4□	60ohm ±25%	200mA	0.15ohm max.	-55°C to +125°C
BLA31AG121SN4□	120ohm ±25%	150mA	0.20ohm max.	-55°C to +125°C
BLA31AG221SN4□	220ohm ±25%	150mA	0.25ohm max.	-55°C to +125°C
BLA31AG601SN4□	600ohm ±25%	100mA	0.35ohm max.	-55°C to +125°C
BLA31AG102SN4□	1000ohm ±25%	50mA	0.45ohm max.	-55°C to +125°C
BLA31BD121SN4□	120ohm ±25%	150mA	0.30ohm max.	-55°C to +125°C
BLA31BD221SN4□	220ohm ±25%	150mA	0.35ohm max.	-55°C to +125°C
BLA31BD471SN4□	470ohm ±25%	100mA	0.40ohm max.	-55°C to +125°C
BLA31BD601SN4□	600ohm ±25%	100mA	0.45ohm max.	-55°C to +125°C
BLA31BD102SN4□	1000ohm ±25%	50mA	0.55ohm max.	-55°C to +125°C

Number of Circuits: 4

## ■ Impedance-Frequency Characteristics

### BLA31AG Series

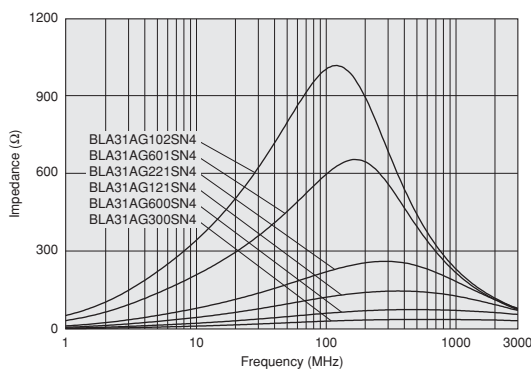

### BLA31BD Series

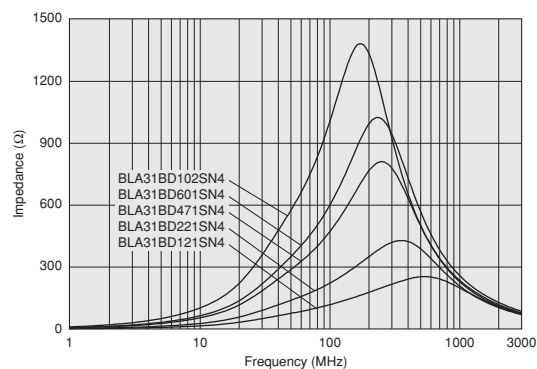

Continued on the following page.

⚠Note • Please read rating and ⚠CAUTION (for storage, operating, rating, soldering, mounting and handling) in this catalog to prevent smoking and/or burning, etc.  
 • This catalog has only typical specifications. Therefore, please approve our product specifications or transact the approval sheet for product specifications before ordering.

Impedance-Frequency Characteristics

Chip Ferrite Bead  
 1206/3216 (inch/mm)

Chip EMIFIL®

Chip Common Mode Choke Coil

Block Type EMIFIL®

Microwave Absorber

BLA31AG300SN4

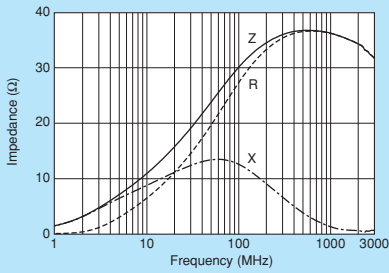

BLA31AG600SN4

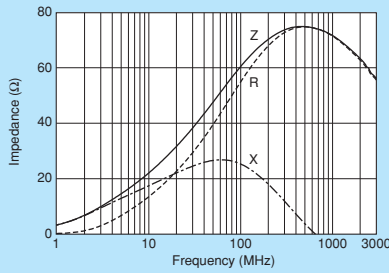

BLA31AG121SN4

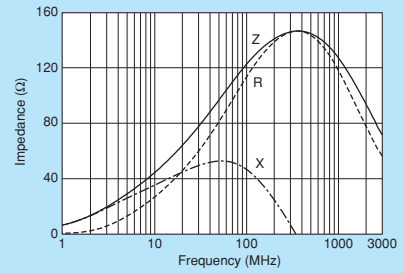

BLA31AG221SN4

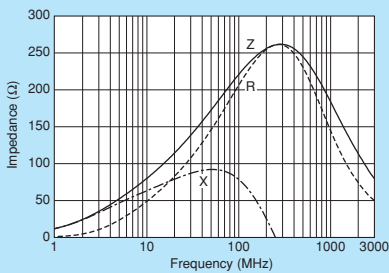

BLA31AG601SN4

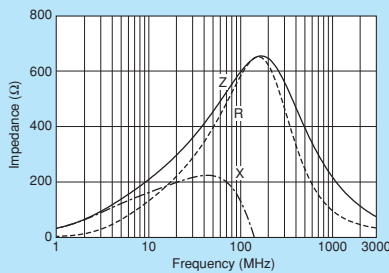

BLA31AG102SN4

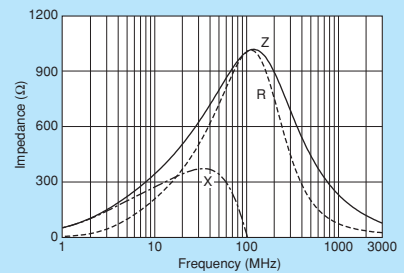

BLA31BD121SN4

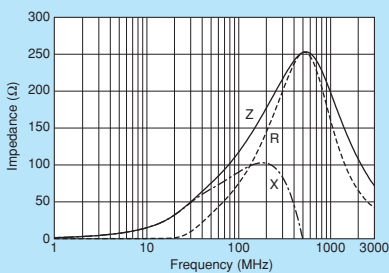

BLA31BD221SN4

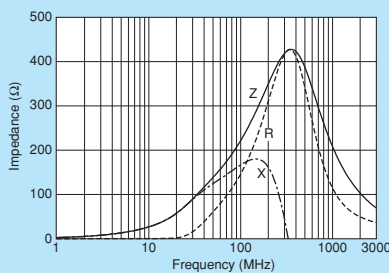

BLA31BD471SN4

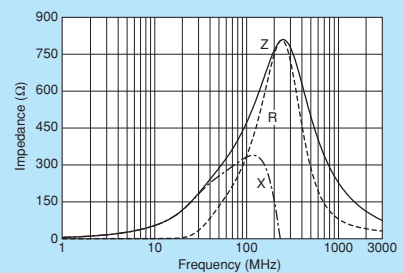

BLA31BD601SN4

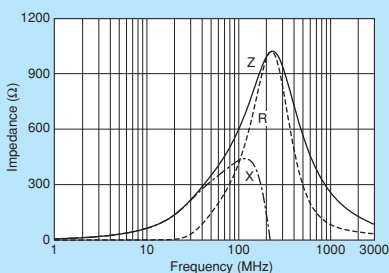

BLA31BD102SN4

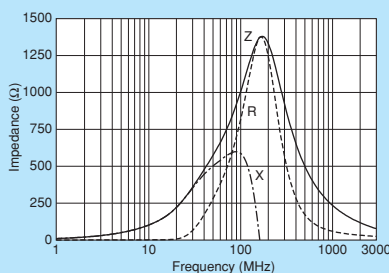

⚠ Note • Please read rating and ⚠ CAUTION (for storage, operating, rating, soldering, mounting and handling) in this catalog to prevent smoking and/or burning, etc.  
 • This catalog has only typical specifications. Therefore, please approve our product specifications or transact the approval sheet for product specifications before ordering.

# BLM03H Series 0201/0603 (inch/mm)



0201 size for GHz band noise.

### ■ Dimensions

### ■ Equivalent Circuit

(Resistance element becomes dominant at high frequencies.)

### ■ Packaging

Code	Packaging	Minimum Quantity
D	180mm Reel Paper Tape	15000
J	330mm Reel Paper Tape	50000
B	Bulk(Bag)	1000

Refer to pages from p.100 to p.103 for mounting information.

### ■ Rated Value (□: packaging code)

Part Number	Impedance (at 100MHz/20°C)	Impedance (at 1GHz/20°C)	Rated Current	DC Resistance	Operating Temperature Range	
BLM03HG601SN1□	600ohm ±25%	1000ohm ±40%	150mA	1.6ohm max.	-55°C to +125°C	Kit
BLM03HG102SN1□	1000ohm ±25%	1800ohm ±40%	125mA	2.6ohm max.	-55°C to +125°C	Kit
BLM03HG122SN1□	1200ohm ±25%	2000ohm ±40%	100mA	3.5ohm max.	-55°C to +125°C	New
BLM03HD331SN1□	330ohm ±25%	750ohm ±40%	200mA	1.0ohm max.	-55°C to +125°C	Kit
BLM03HD471SN1□	470ohm ±25%	1000ohm ±40%	175mA	1.3ohm max.	-55°C to +125°C	Kit
BLM03HD601SN1□	600ohm ±25%	1500ohm ±40%	150mA	1.7ohm max.	-55°C to +125°C	Kit
BLM03HD102SN1□	1000ohm ±25%	2300ohm ±40%	120mA	2.9ohm max.	-55°C to +125°C	Kit
BLM03HB191SN1□	190ohm ±25%	1150ohm ±40%	150mA	2.0ohm max.	-55°C to +125°C	Kit

Number of Circuits: 1

### ■ Impedance-Frequency Characteristics

#### BLM03HG Series

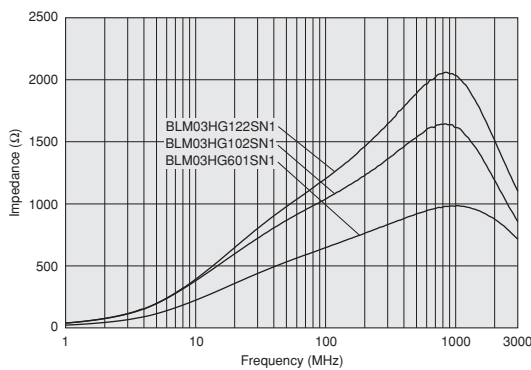

#### BLM03HD Series

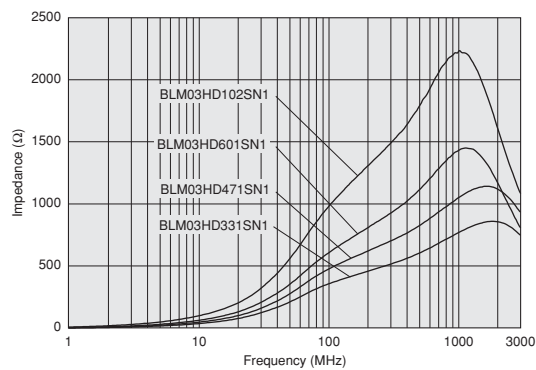

#### BLM03HB Series

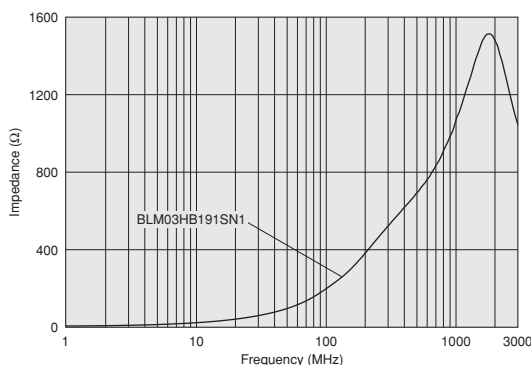

Continued on the following page.

⚠Note • Please read rating and ⚠CAUTION (for storage, operating, rating, soldering, mounting and handling) in this catalog to prevent smoking and/or burning, etc.  
• This catalog has only typical specifications. Therefore, please approve our product specifications or transact the approval sheet for product specifications before ordering.

Impedance-Frequency Characteristics

BLM03HG601SN1

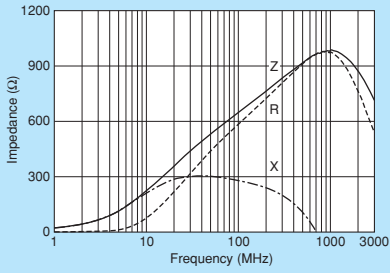

BLM03HG102SN1

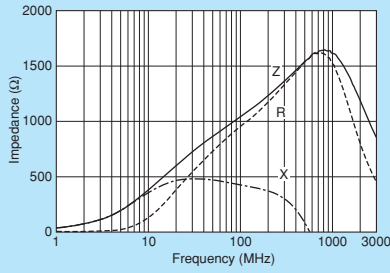

BLM03HG122SN1

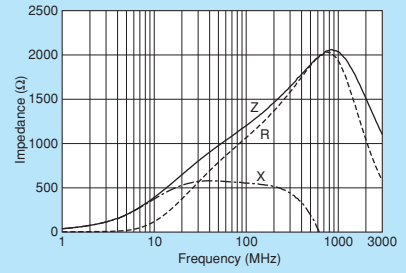

BLM03HD331SN1

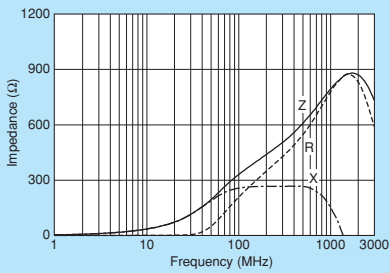

BLM03HD471SN1

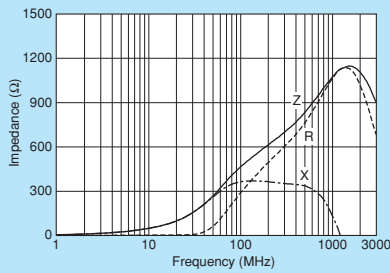

BLM03HD601SN1

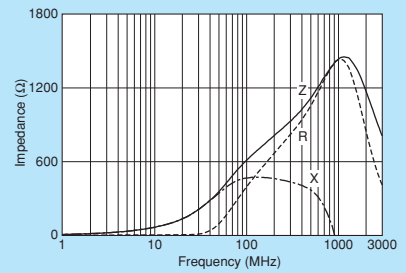

BLM03HD102SN1

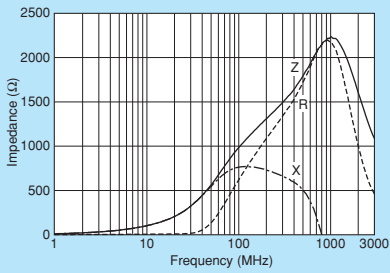

BLM03HB191SN1

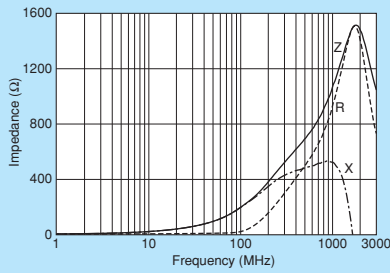

⚠ Note • Please read rating and ⚠ CAUTION (for storage, operating, rating, soldering, mounting and handling) in this catalog to prevent smoking and/or burning, etc.  
 • This catalog has only typical specifications. Therefore, please approve our product specifications or transact the approval sheet for product specifications before ordering.

Chip Ferrite Bead  
0201/0603 (inch/mm)

Chip EMIFIL®

Chip Common Mode Choke Coil

Block Type EMIFIL®

Microwave Absorber



# BLM03E Series 0201/0603 (inch/mm)



For GHz band noise and capable of large current.

### ■ Dimensions

■ : Electrode  
(in mm)

### ■ Equivalent Circuit

(Resistance element becomes dominant at high frequencies.)

### ■ Packaging

Code	Packaging	Minimum Quantity
D	180mm Reel Paper Tape	15000
J	330mm Reel Paper Tape	50000
B	Bulk(Bag)	1000

Refer to pages from p.100 to p.103 for mounting information.

### ■ Rated Value (□: packaging code)

Part Number	Impedance (at 100MHz/20°C)	Impedance (at 1GHz/20°C)	Rated Current	DC Resistance	Operating Temperature Range	
BLM03EB250SN1 □	25ohm ±25%	105ohm ±40%	600mA	0.26ohm max.	-55°C to +125°C	Kit
BLM03EB500SN1 □	50ohm ±25%	255ohm ±40%	400mA	0.58ohm max.	-55°C to +125°C	Kit

Number of Circuits: 1

### ■ Impedance-Frequency Characteristics

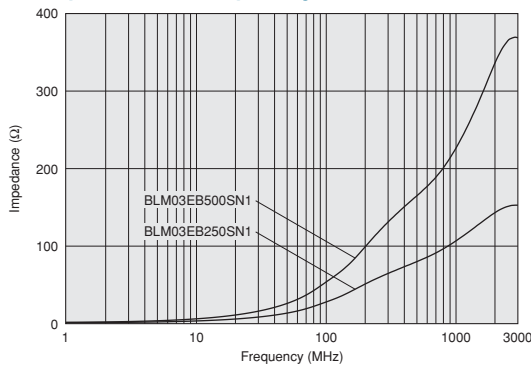

### ■ Notice (Rating)

In operating temperature exceeding +85°C, derating of current is necessary for BLM03E series. Please apply the derating curve shown in chart according to the operating temperature.

Derating of Rated Current

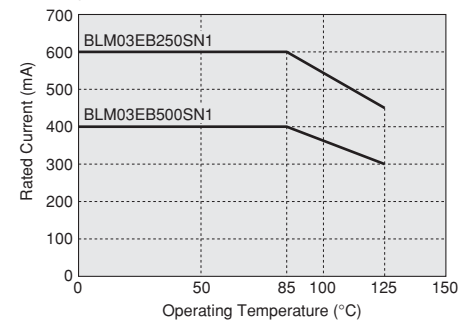

### ■ Impedance-Frequency Characteristics

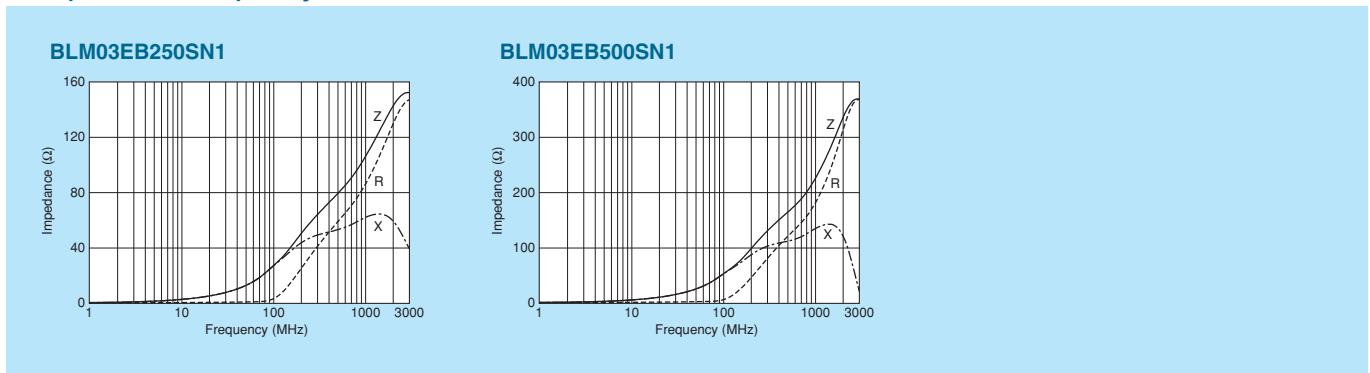

△Note • Please read rating and △CAUTION (for storage, operating, rating, soldering, mounting and handling) in this catalog to prevent smoking and/or burning, etc.  
• This catalog has only typical specifications. Therefore, please approve our product specifications or transact the approval sheet for product specifications before ordering.

# BLM15H Series 0402/1005 (inch/mm)



0402 size for GHz band noise.

Chip Ferrite Bead  
0402/1005 (inch/mm)



### ■ Dimensions

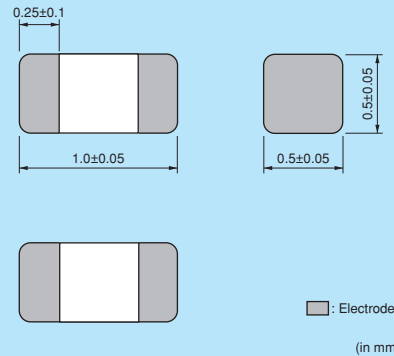

### ■ Equivalent Circuit

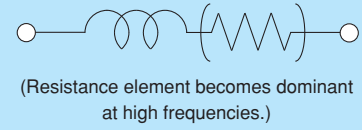

### ■ Packaging

Code	Packaging	Minimum Quantity
D	180mm Reel Paper Tape	10000
J	330mm Reel Paper Tape	50000
B	Bulk(Bag)	1000

Refer to pages from p.100 to p.103 for mounting information.

### ■ Rated Value (□: packaging code)

Part Number	Impedance (at 100MHz/20°C)	Impedance (at 1GHz/20°C)	Rated Current	DC Resistance	Operating Temperature Range	
BLM15HG601SN1□	600ohm ±25%	1000ohm ±40%	300mA	0.7ohm max.	-55°C to +125°C	Kit
BLM15HG102SN1□	1000ohm ±25%	1400ohm ±40%	250mA	1.1ohm max.	-55°C to +125°C	Kit
BLM15HD601SN1□	600ohm ±25%	1400ohm ±40%	300mA	0.85ohm max.	-55°C to +125°C	Kit
BLM15HD102SN1□	1000ohm ±25%	2000ohm ±40%	250mA	1.25ohm max.	-55°C to +125°C	Kit
BLM15HD182SN1□	1800ohm ±25%	2700ohm ±40%	200mA	2.2ohm max.	-55°C to +125°C	Kit
BLM15HB121SN1□	120ohm ±25%	500ohm ±40%	300mA	0.7ohm max.	-55°C to +125°C	Kit
BLM15HB221SN1□	220ohm ±25%	900ohm ±40%	250mA	1.0ohm max.	-55°C to +125°C	Kit

Number of Circuits: 1

### ■ Impedance-Frequency Characteristics

#### BLM15HG Series (For General Signal Lines)

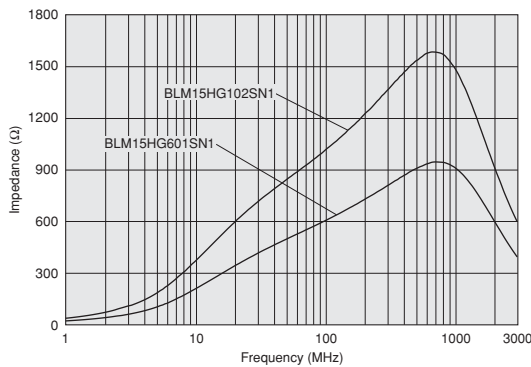

#### BLM15HD Series (For High Speed Signal Lines)

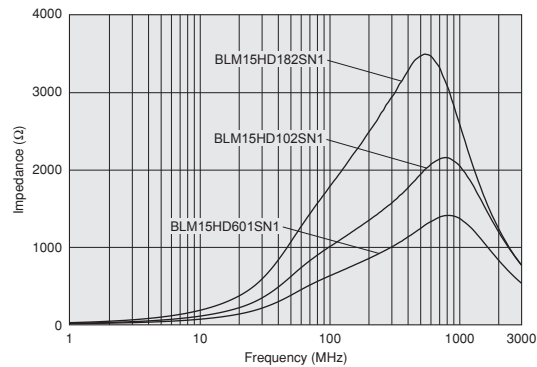

#### BLM15HB Series (For High Speed Signal Lines)

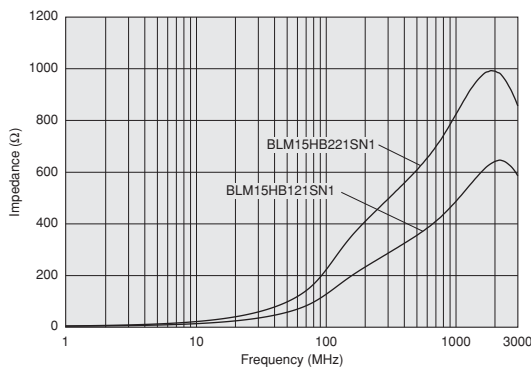

Continued on the following page.

△Note • Please read rating and △CAUTION (for storage, operating, rating, soldering, mounting and handling) in this catalog to prevent smoking and/or burning, etc.  
• This catalog has only typical specifications. Therefore, please approve our product specifications or transact the approval sheet for product specifications before ordering.

Chip EMIFIL®

Chip Common Mode Choke Coil

Block Type EMIFIL®

Microwave Absorber

Impedance-Frequency Characteristics

BLM15HG601SN1

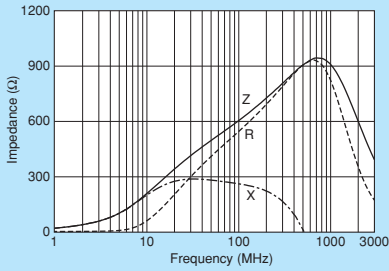

BLM15HG102SN1

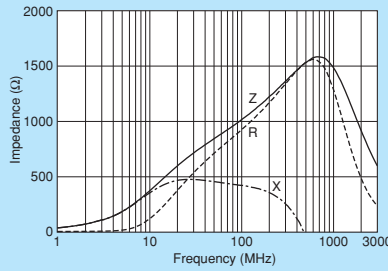

BLM15HD601SN1

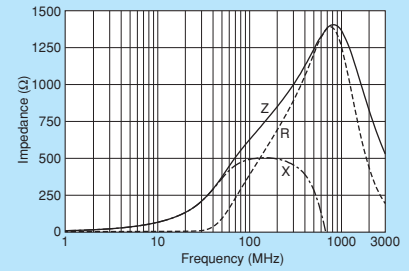

BLM15HD102SN1

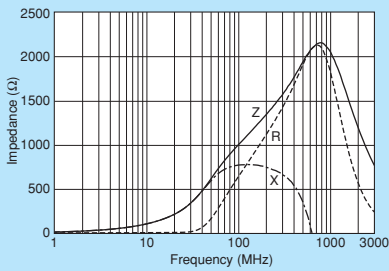

BLM15HD182SN1

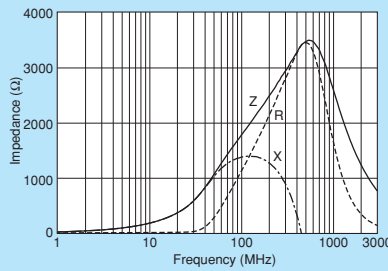

BLM15HB121SN1

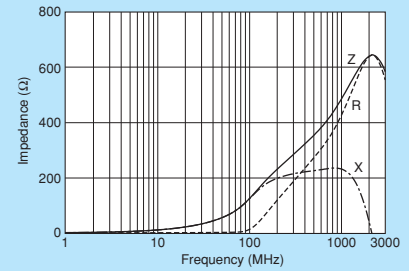

BLM15HB221SN1

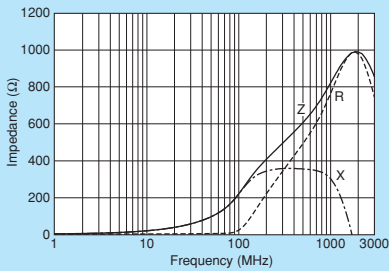

0402/1005 (inch/mm)  
Chip Ferrite Bead

Chip EMIFIL®

Chip Common Mode Choke Coil

Block Type EMIFIL®

Microwave Absorber

⚠Note • Please read rating and ⚠CAUTION (for storage, operating, rating, soldering, mounting and handling) in this catalog to prevent smoking and/or burning, etc.  
 • This catalog has only typical specifications. Therefore, please approve our product specifications or transact the approval sheet for product specifications before ordering.

# BLM15E Series 0402/1005 (inch/mm)



For GHz band noise, also capable to large current.

Chip Ferrite Bead 0402/1005 (inch/mm)



### ■ Dimensions

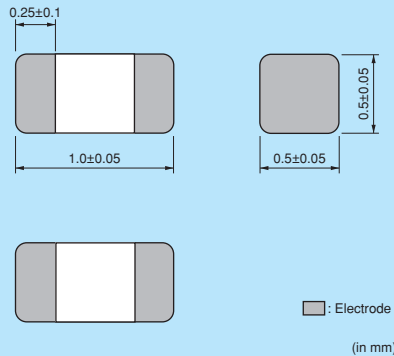

### ■ Equivalent Circuit

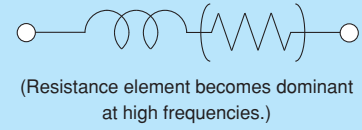

### ■ Packaging

Code	Packaging	Minimum Quantity
D	180mm Reel Paper Tape	10000
J	330mm Reel Paper Tape	50000
B	Bulk(Bag)	1000

Refer to pages from p.100 to p.103 for mounting information.

### ■ Rated Value (□: packaging code)

Part Number	Impedance (at 100MHz/20°C)	Impedance (at 1GHz/20°C)	Rated Current	DC Resistance	Operating Temperature Range	
BLM15EG121SN1□	120ohm ±25%	145ohm (Typ.)	1500mA	0.095ohm max.	-55°C to +125°C	Kit ≥1A
BLM15EG221SN1□	220ohm ±25%	270ohm (Typ.)	700mA	0.28ohm max.	-55°C to +125°C	Kit

Number of Circuits: 1

Chip EMIFIL®

Chip Common Mode Choke Coil

### ■ Impedance-Frequency Characteristics

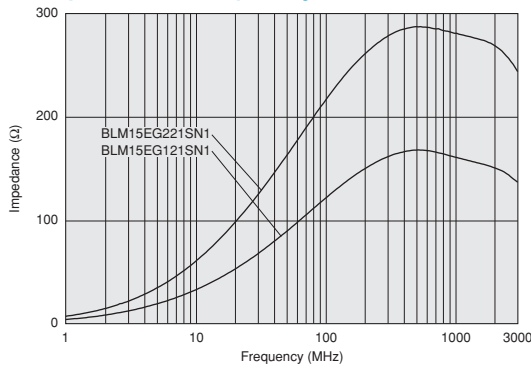

### ■ Notice (Rating)

In operating temperature exceeding +85°C, derating of current is necessary for BLM15E series. Please apply the derating curve shown in chart according to the operating temperature.

#### Derating of Rated Current

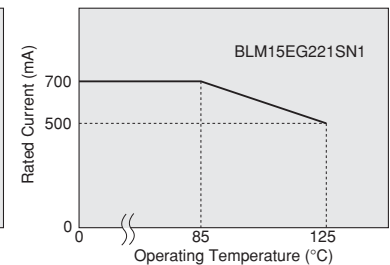
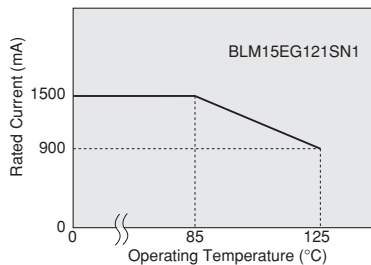

Block Type EMIFIL®

### ■ Impedance-Frequency Characteristics

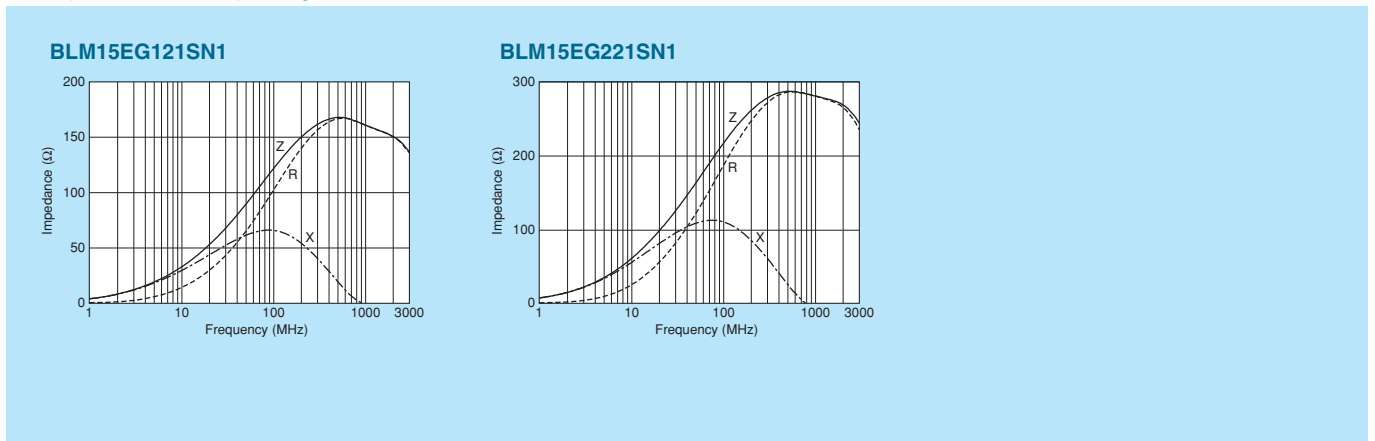

△Note • Please read rating and △CAUTION (for storage, operating, rating, soldering, mounting and handling) in this catalog to prevent smoking and/or burning, etc.  
• This catalog has only typical specifications. Therefore, please approve our product specifications or transact the approval sheet for product specifications before ordering.

Microwave Absorber

# BLM15G Series 0402/1005 (inch/mm)



Available up to high-GHz band noise.



### ■ Dimensions

(in mm)

### ■ Equivalent Circuit



(Resistance element becomes dominant at high frequencies.)

### ■ Packaging

Code	Packaging	Minimum Quantity
D	180mm Reel Paper Tape	10000
J	330mm Reel Paper Tape	50000
B	Bulk(Bag)	1000

Refer to pages from p.100 to p.103 for mounting information.

### ■ Rated Value (□: packaging code)

Part Number	Impedance (at 100MHz/20°C)	Impedance (at 1GHz/20°C)	Rated Current	DC Resistance	Operating Temperature Range	
BLM15GG221SN1□	220ohm ±25%	600ohm ±40%	300mA	0.7ohm max.	-55°C to +125°C	Kit
BLM15GG471SN1□	470ohm ±25%	1200ohm ±40%	200mA	1.3ohm max.	-55°C to +125°C	Kit
BLM15GA750SN1□	75ohm ±25%	1000ohm ±40%	200mA	1.3ohm max.	-55°C to +125°C	Kit

Number of Circuits: 1

### ■ Impedance-Frequency Characteristics

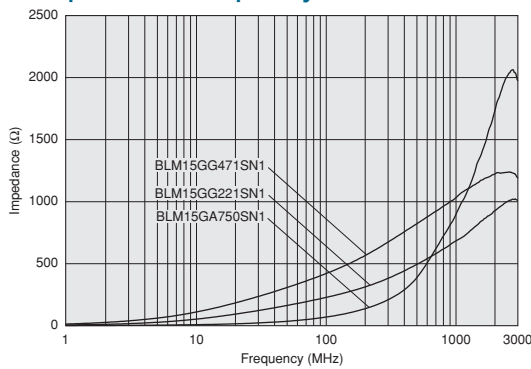

### ■ Impedance-Frequency Characteristics

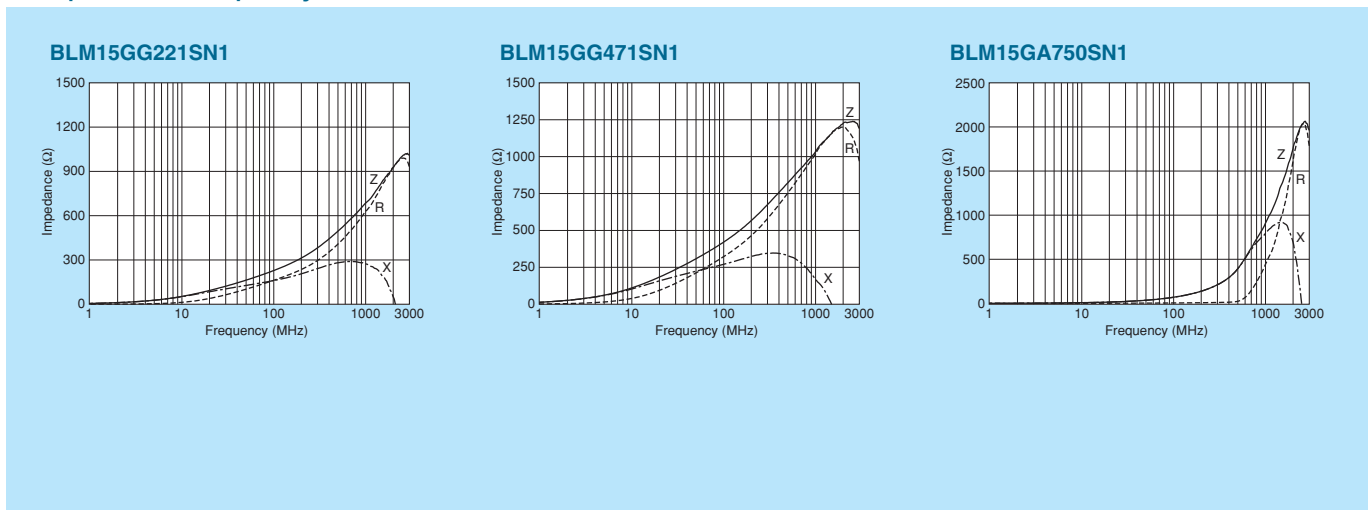

⚠Note • Please read rating and ⚠CAUTION (for storage, operating, rating, soldering, mounting and handling) in this catalog to prevent smoking and/or burning, etc.  
 • This catalog has only typical specifications. Therefore, please approve our product specifications or transact the approval sheet for product specifications before ordering.

# BLM18H Series 0603/1608 (inch/mm)



0603 size for GHz band noise. BLM18HE also supports power lines.

\*Please refer to BLM15H for downsizing.

Chip Ferrite Bead  
0603/1608 (inch/mm)

Chip EMIFIL®

Chip Common Mode Choke Coil

Block Type EMIFIL®

Microwave Absorber



### ■ Dimensions

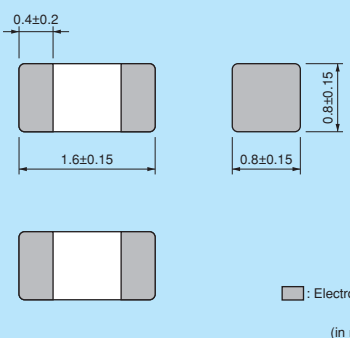

(in mm)

### ■ Equivalent Circuit



(Resistance element becomes dominant at high frequencies.)

### ■ Packaging

Code	Packaging	Minimum Quantity
D	180mm Reel Paper Tape	4000
J	330mm Reel Paper Tape	10000
B	Bulk(Bag)	1000

Refer to pages from p.100 to p.103 for mounting information.

### ■ Rated Value (□: packaging code)

Part Number	Impedance (at 100MHz/20°C)	Impedance (at 1GHz/20°C)	Rated Current	DC Resistance	Operating Temperature Range	
BLM18HG471SN1□	470ohm ±25%	600ohm (Typ.)	200mA	0.85ohm max.	-55°C to +125°C	Kit
BLM18HG601SN1□	600ohm ±25%	700ohm (Typ.)	200mA	1.00ohm max.	-55°C to +125°C	Kit
BLM18HG102SN1□	1000ohm ±25%	1000ohm (Typ.)	100mA	1.60ohm max.	-55°C to +125°C	Kit
BLM18HE601SN1□	600ohm ±25%	600ohm (Typ.)	800mA	0.25ohm max.	-55°C to +125°C	Kit
BLM18HE102SN1□	1000ohm ±25%	1000ohm (Typ.)	600mA	0.35ohm max.	-55°C to +125°C	Kit
BLM18HE152SN1□	1500ohm ±25%	1500ohm (Typ.)	500mA	0.50ohm max.	-55°C to +125°C	Kit
BLM18HD471SN1□	470ohm ±25%	1000ohm (Typ.)	100mA	1.20ohm max.	-55°C to +125°C	Kit
BLM18HD601SN1□	600ohm ±25%	1200ohm (Typ.)	100mA	1.50ohm max.	-55°C to +125°C	Kit
BLM18HD102SN1□	1000ohm ±25%	1700ohm (Typ.)	50mA	1.80ohm max.	-55°C to +125°C	Kit
BLM18HB121SN1□	120ohm ±25%	500ohm ±40%	200mA	0.50ohm max.	-55°C to +125°C	Kit
BLM18HB221SN1□	220ohm ±25%	1100ohm ±40%	100mA	0.80ohm max.	-55°C to +125°C	Kit
BLM18HB331SN1□	330ohm ±25%	1600ohm ±40%	50mA	1.20ohm max.	-55°C to +125°C	Kit
BLM18HK331SN1□	330ohm ±25%	400ohm ±40%	200mA	0.50ohm max.	-55°C to +125°C	Kit
BLM18HK471SN1□	470ohm ±25%	600ohm ±40%	200mA	0.70ohm max.	-55°C to +125°C	Kit
BLM18HK601SN1□	600ohm ±25%	700ohm ±40%	100mA	0.90ohm max.	-55°C to +125°C	Kit
BLM18HK102SN1□	1000ohm ±25%	1200ohm ±40%	50mA	1.50ohm max.	-55°C to +125°C	Kit

Number of Circuits: 1

### ■ Impedance-Frequency Characteristics BLM18HG Series (For General Signal Lines)

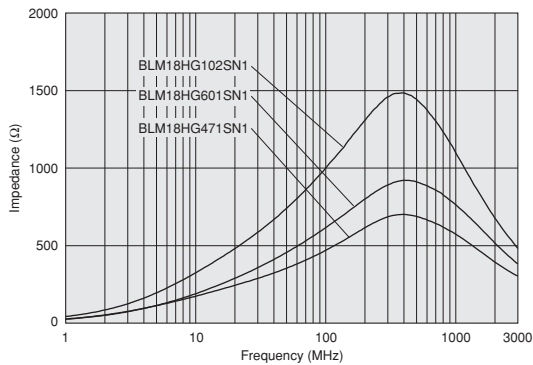

### ■ Impedance-Frequency Characteristics BLM18HE Series (For High Speed Signal Lines)

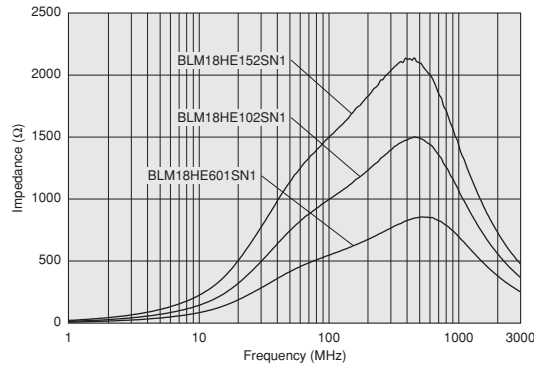

Continued on the following page. ↗

△Note • Please read rating and △CAUTION (for storage, operating, rating, soldering, mounting and handling) in this catalog to prevent smoking and/or burning, etc.  
• This catalog has only typical specifications. Therefore, please approve our product specifications or transact the approval sheet for product specifications before ordering.

**Impedance-Frequency Characteristics**  
**BLM18HD Series (For High Speed Signal Lines)**

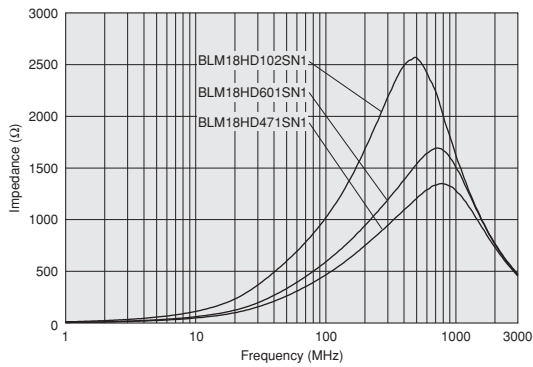

**BLM18HB Series (For High Speed Signal Lines)**

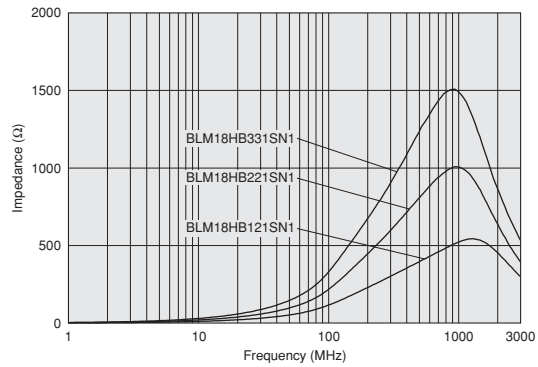

**BLM18HK Series (For Digital Interface Lines)**

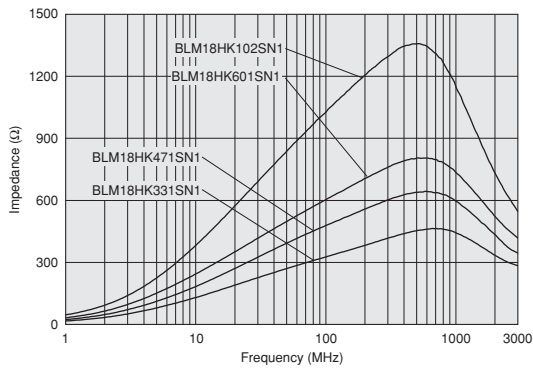

**Notice (Rating)**

In operating temperature exceeding +85°C, derating of current is necessary for BLM18HE series.

Please apply the derating curve shown in chart according to the operating temperature.

Derating of Rated Current

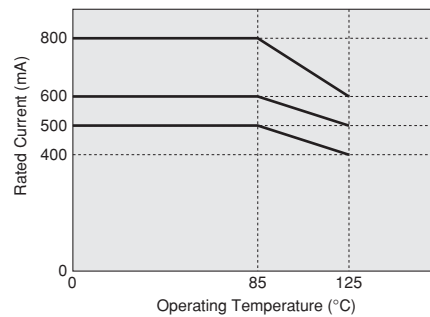

**Impedance-Frequency Characteristics**

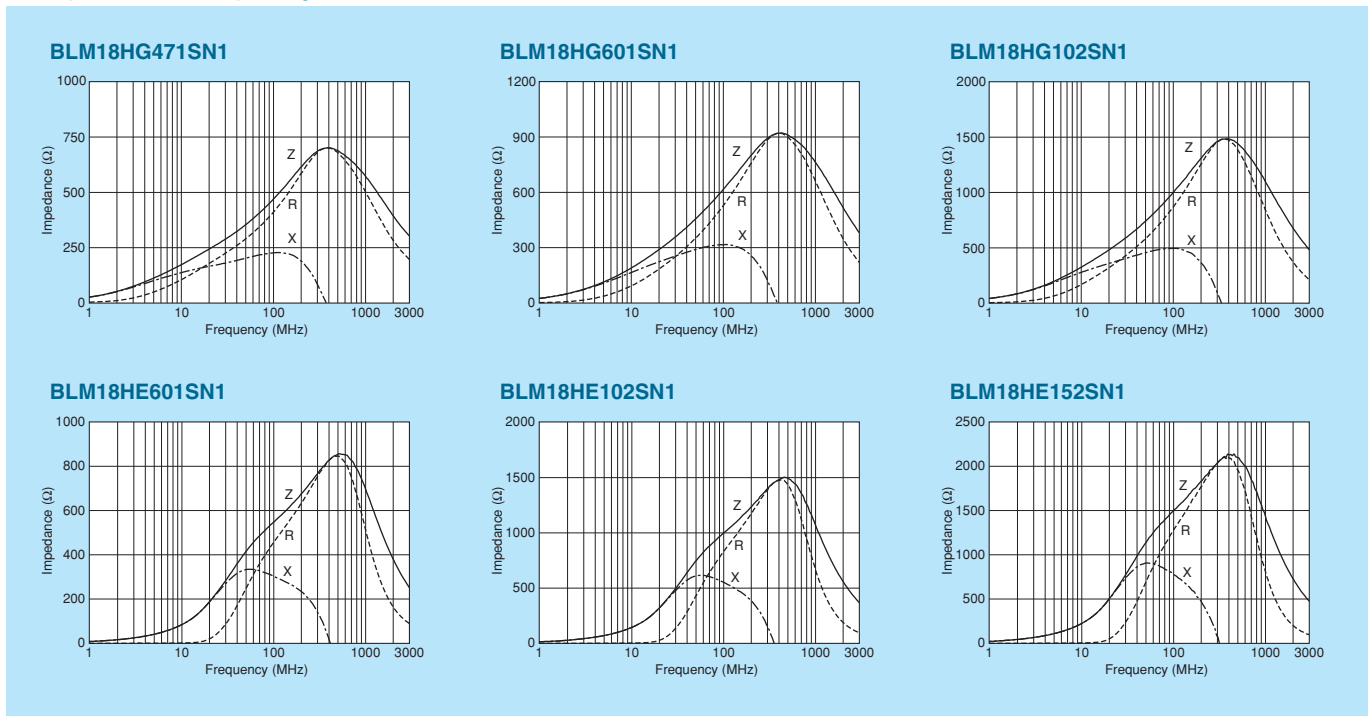

Continued on the following page.

**Note** • Please read rating and **CAUTION** (for storage, operating, rating, soldering, mounting and handling) in this catalog to prevent smoking and/or burning, etc.  
 • This catalog has only typical specifications. Therefore, please approve our product specifications or transact the approval sheet for product specifications before ordering.

Impedance-Frequency Characteristics

BLM18HD471SN1

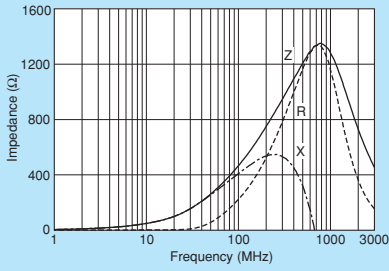

BLM18HD601SN1

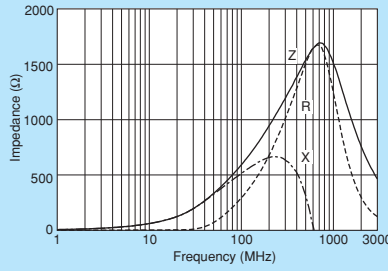

BLM18HD102SN1

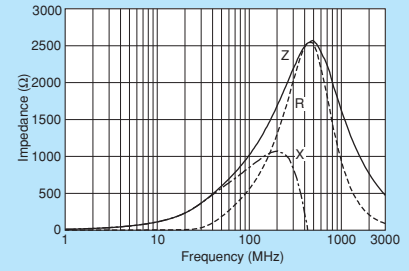

BLM18HB121SN1

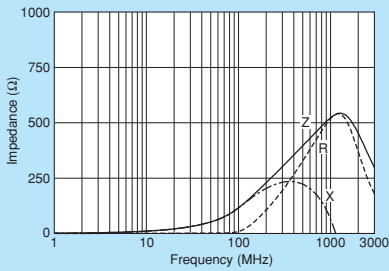

BLM18HB221SN1

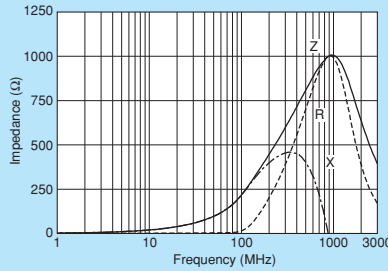

BLM18HB331SN1

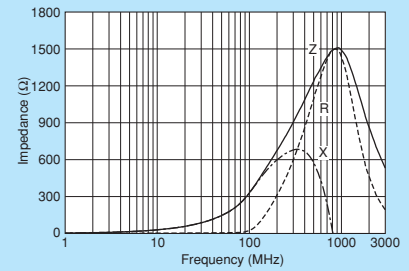

BLM18HK331SN1

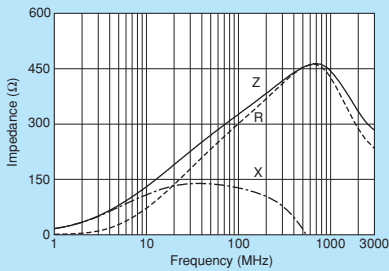

BLM18HK471SN1

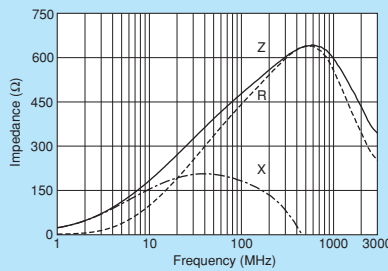

BLM18HK601SN1

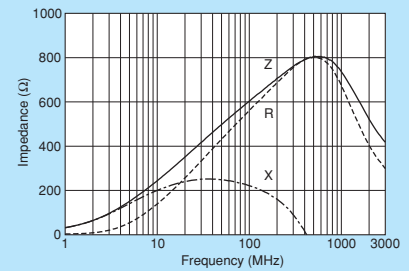

BLM18HK102SN1

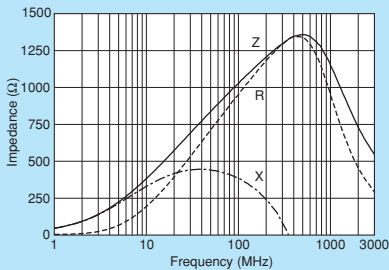

⚠ Note • Please read rating and ⚠ CAUTION (for storage, operating, rating, soldering, mounting and handling) in this catalog to prevent smoking and/or burning, etc.  
 • This catalog has only typical specifications. Therefore, please approve our product specifications or transact the approval sheet for product specifications before ordering.

Chip Ferrite Bead  
 0603/1608 (inch/mm)

Chip EMIFIL®

Chip Common Mode Choke Coil

Block Type EMIFIL®

Microwave Absorber



# Noise Suppression of BLM18H in UHF Range

Testing Circuit

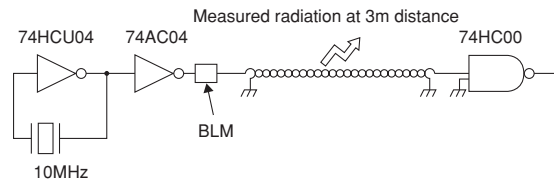

Type of Filter	EMI Suppression Effect / Description
Initial (No filter)	
Conventional Type BLM18AG102SN1 (1000Ω at 100MHz)	<p>Current BLM18AG are effective in suppressing noise in the range between 300MHz and 700MHz.</p>
for GHz Noise Suppression BLM18HG102SN1 (1000Ω at 100MHz)	<p>In addition to the effectiveness of current BLM, BLM18HG suppresses noise in the range beyond 700MHz.</p>

Comparison between BLM18HG102SN1 and BLM18AG102SN1 (Current Item)

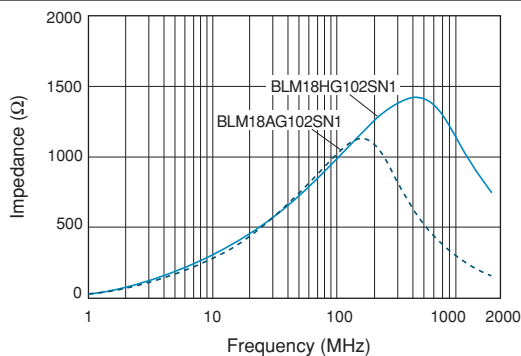

⚠Note • Please read rating and ⚠CAUTION (for storage, operating, rating, soldering, mounting and handling) in this catalog to prevent smoking and/or burning, etc.  
• This catalog has only typical specifications. Therefore, please approve our product specifications or transact the approval sheet for product specifications before ordering.

# BLM18E Series 0603/1608 (inch/mm)



For GHz band noise, also capable to large current.

Chip Ferrite Bead  
0603/1608 (inch/mm)

Chip EMIFIL®

Chip Common Mode Choke Coil

Block Type EMIFIL®

Microwave Absorber



### ■ Dimensions

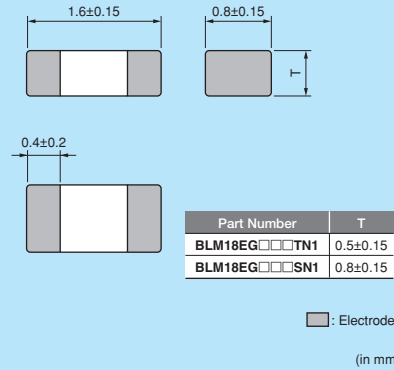

### ■ Equivalent Circuit

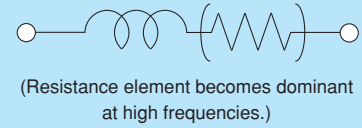

### ■ Packaging

Code	Packaging	Minimum Quantity
D	180mm Reel Paper Tape	4000
J	330mm Reel Paper Tape	10000
B	Bulk(Bag)	1000

Refer to pages from p.100 to p.103 for mounting information.

### ■ Rated Value (□: packaging code)

Part Number	Impedance (at 100MHz/20°C)	Impedance (at 1GHz/20°C)	Rated Current	DC Resistance	Operating Temperature Range	Kit
BLM18EG101TN1□	100ohm ±25%	140ohm (Typ.)	2000mA	0.045ohm max.	-55°C to +125°C	Kit ≥1A
BLM18EG121SN1□	120ohm ±25%	145ohm (Typ.)	2000mA	0.04ohm max.	-55°C to +125°C	Kit ≥1A
BLM18EG221SN1□	220ohm ±25%	260ohm (Typ.)	2000mA	0.05ohm max.	-55°C to +125°C	Kit ≥1A
BLM18EG221TN1□	220ohm ±25%	300ohm (Typ.)	1000mA	0.15ohm max.	-55°C to +125°C	Kit ≥1A
BLM18EG331TN1□	330ohm ±25%	450ohm (Typ.)	500mA	0.21ohm max.	-55°C to +125°C	Kit
BLM18EG391TN1□	390ohm ±25%	520ohm (Typ.)	500mA	0.3ohm max.	-55°C to +125°C	Kit
BLM18EG471SN1□	470ohm ±25%	550ohm (Typ.)	500mA	0.21ohm max.	-55°C to +125°C	Kit
BLM18EG601SN1□	600ohm ±25%	700ohm (Typ.)	500mA	0.35ohm max.	-55°C to +125°C	Kit

Number of Circuits: 1

### ■ Impedance-Frequency Characteristics BLM18EG\_TN1 Series

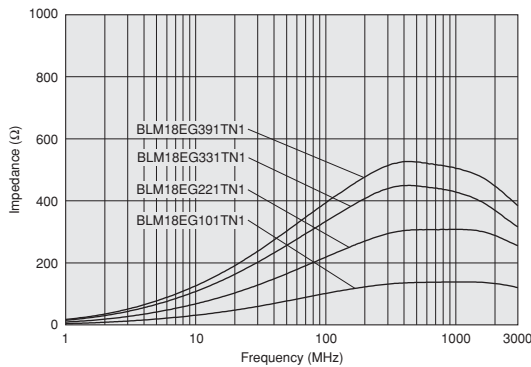

### ■ Impedance-Frequency Characteristics BLM18EG\_SN1 Series

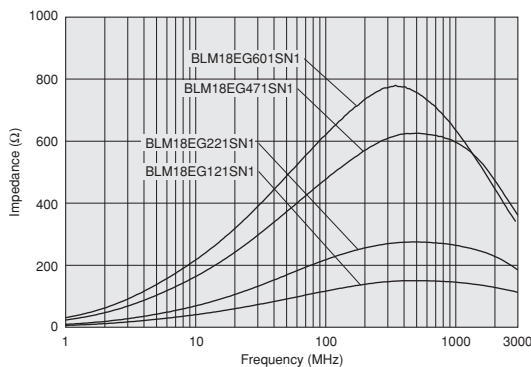

### ■ Notice (Rating)

In operating temperature exceeding +85°C, derating of current is necessary for BLM18EG series. Please apply the derating curve shown in chart according to the operating temperature.

Derating of Rated Current

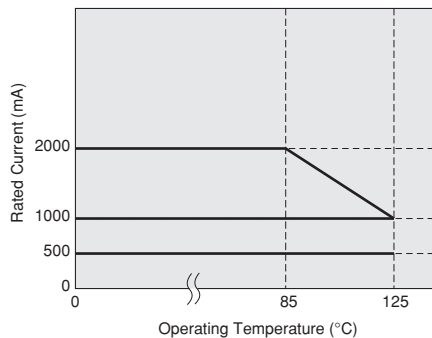

Continued on the following page.

△Note • Please read rating and △CAUTION (for storage, operating, rating, soldering, mounting and handling) in this catalog to prevent smoking and/or burning, etc.  
 • This catalog has only typical specifications. Therefore, please approve our product specifications or transact the approval sheet for product specifications before ordering.

Impedance-Frequency Characteristics

BLM18EG101TN1

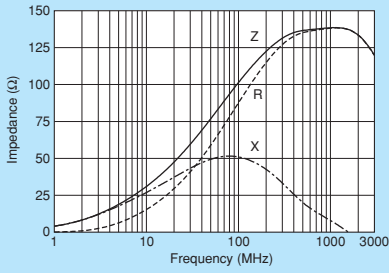

BLM18EG121SN1

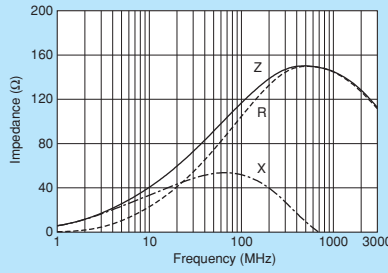

BLM18EG221SN1

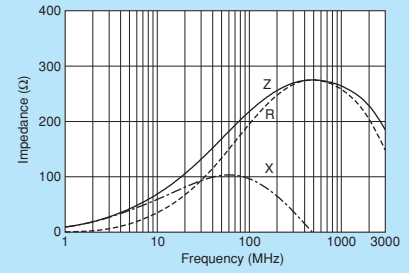

BLM18EG221TN1

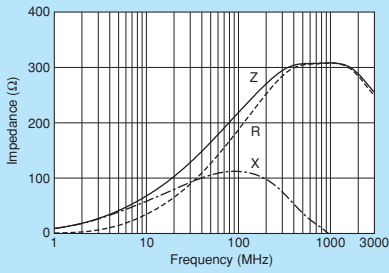

BLM18EG331TN1

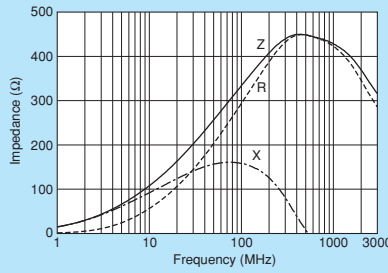

BLM18EG391TN1

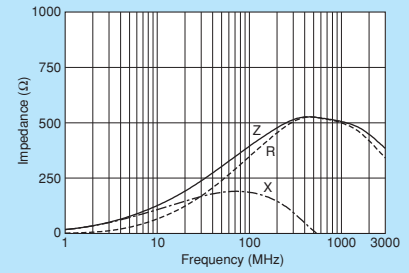

BLM18EG471SN1

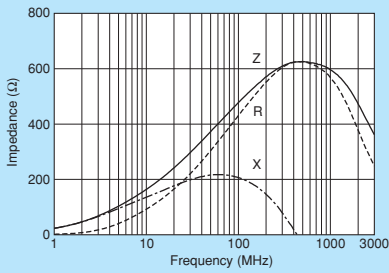

BLM18EG601SN1

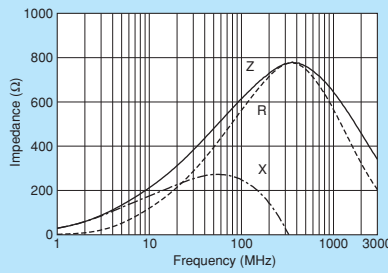

0603/1608 (inch/mm)  
Chip Ferrite Bead

Chip EMIFIL®

Chip Common Mode Choke Coil

Block Type EMIFIL®

Microwave Absorber

⚠Note • Please read rating and ⚠CAUTION (for storage, operating, rating, soldering, mounting and handling) in this catalog to prevent smoking and/or burning, etc.  
 • This catalog has only typical specifications. Therefore, please approve our product specifications or transact the approval sheet for product specifications before ordering.

# BLM18G Series 0603/1608 (inch/mm)



Available up to high-GHz band noise.

Chip Ferrite Bead  
0603/1608 (inch/mm)



### ■ Dimensions

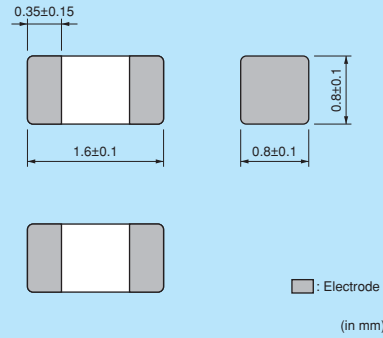

### ■ Equivalent Circuit

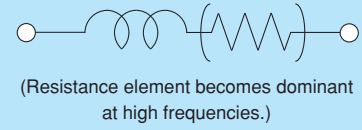

### ■ Packaging

Code	Packaging	Minimum Quantity
D	180mm Reel Paper Tape	4000
J	330mm Reel Paper Tape	10000
B	Bulk(Bag)	1000

Refer to pages from p.100 to p.103 for mounting information.

### ■ Rated Value (□: packaging code)

Part Number	Impedance (at 100MHz/20°C)	Impedance (at 1GHz/20°C)	Rated Current	DC Resistance	Operating Temperature Range	
BLM18GG471SN1□	470ohm ±25%	1800ohm ±30%	200mA	1.0ohm ±0.3ohm	-55°C to +125°C	Kit

Number of Circuits: 1

Chip EMIFIL®

Chip Common Mode Choke Coil

### ■ Impedance-Frequency Characteristics

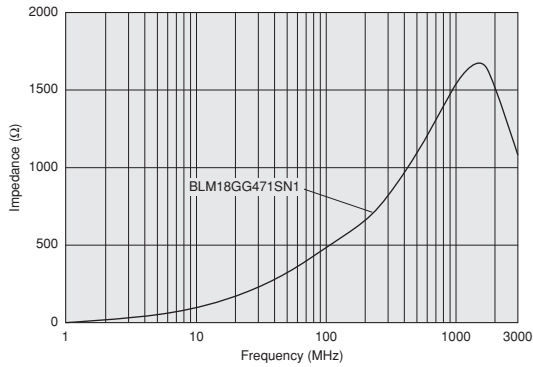

Block Type EMIFIL®

### ■ Impedance-Frequency Characteristics

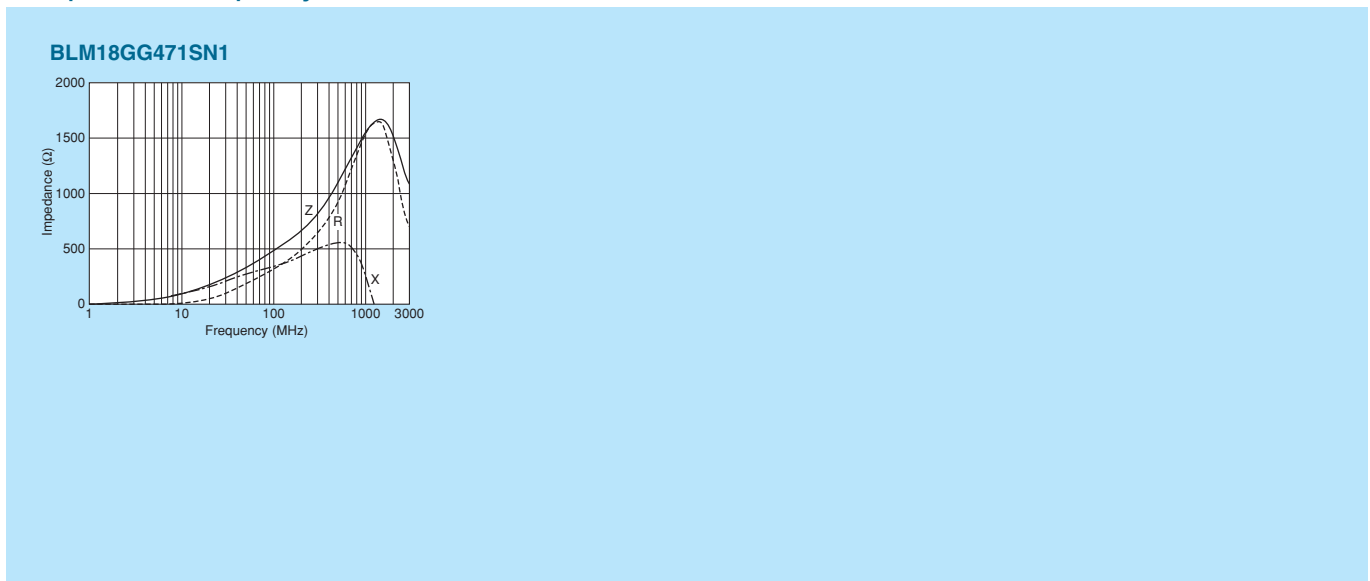

△Note • Please read rating and △CAUTION (for storage, operating, rating, soldering, mounting and handling) in this catalog to prevent smoking and/or burning, etc.  
• This catalog has only typical specifications. Therefore, please approve our product specifications or transact the approval sheet for product specifications before ordering.

Microwave Absorber

## ⚠ Caution

## ● Rating

1. About the Rated Current  
Do not use products beyond the rated current as this may create excessive heat and deteriorate the insulation resistance.
2. About the Excessive Surge Current  
Excessive surge current ( pulse current or rush current) than specified rated current applied to the product may cause a critical failure, such as an open circuit, burnout caused by excessive temperature rise. Please contact us in advance in case of applying the surge current.

## ● Soldering and Mounting

- Self-heating  
Please pay special attention when mounting chip ferrite beads BLM\_AX/P/K/S series bead inductor BLE series in close proximity to other products that radiate heat.  
The heat generated by other products may deteriorate the insulation resistance and cause excessive heat in this component.

## Notice

## ● Storage and Operating Conditions

## &lt;Operating Environment&gt;

Do not use products in a chemical atmosphere such as chlorine gas, acid or sulfide gas.

Do not use products in the environment close to the organic solvent.

## &lt;Storage and Handling Requirements&gt;

1. Storage Period  
BLM15E/15H/15G series should be used within 12 months, the other series should be used within 6 months.  
Solderability should be checked if this period is exceeded.
2. Storage Conditions
  - (1) Storage temperature: -10 to +40°C  
Relative humidity: 15 to 85%  
Avoid sudden changes in temperature and humidity.
  - (2) Do not store products in a chemical atmosphere such as chlorine gas, acid or sulfide gas.

## ● Notice (Soldering and Mounting)

1. Cleaning  
Failure and degradation of a product are caused by the cleaning method. When you clean in conditions that are not in mounting information, please contact Murata engineering.
2. Soldering  
Reliability decreases with improper soldering methods. Please solder by the standard soldering conditions shown in mounting information.
3. Other  
Noise suppression levels resulting from Murata's EMI suppression filters EMIFIL® may vary, depending on the circuits and ICs used, type of noise, mounting pattern, mounting location, and other operating conditions. Be sure to check and confirm in advance the noise suppression effect of each filter, in actual circuits, etc. before applying the filter in a commercial-purpose equipment design.

## ● Handling

1. Resin Coating  
Using resin for coating/molding products may affect the products performance.  
So please pay careful attention in selecting resin.  
Prior to use, please make the reliability evaluation with the product mounted in your application set.
2. Handling of a Substrate  
After mounting products on a substrate, do not apply any stress to the product caused by bending or twisting to the substrate when cropping the substrate, inserting and removing a connector from the substrate or tightening screw to the substrate.  
Excessive mechanical stress may cause cracking in the Product.

Bending

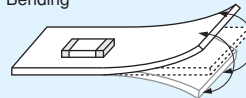

Twisting

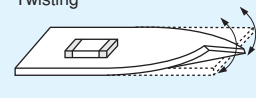

⚠ Note • Please read rating and ⚠ CAUTION (for storage, operating, rating, soldering, mounting and handling) in this catalog to prevent smoking and/or burning, etc.  
• This catalog has only typical specifications. Therefore, please approve our product specifications or transact the approval sheet for product specifications before ordering.

### 1. Standard Land Pattern Dimensions

  
 Land Pattern + Solder Resist
   
 Land Pattern
   
 Solder Resist

(in mm)

**BLE32**  
**BLM02**  
**BLM03**  
**BLM15**  
**BLM18**  
**BLM21**  
**BLM31**  
**BLM41**

●Reflow and Flow  
BLM Series

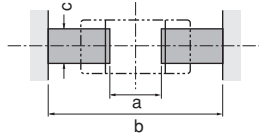

Type	Soldering	a	b	c
<b>BLM02</b>	Reflow	0.16-0.2	0.4-0.56	0.2-0.23
<b>BLM03</b>	Reflow	0.2-0.3	0.6-0.9	0.3
<b>BLM15</b>	Reflow	0.4	1.2-1.4	0.5
<b>BLM18</b> (except 18G)	Flow	0.7	2.2-2.6	0.7
	Reflow		1.8-2.0	
<b>BLM21</b>	Flow/ Reflow	1.2	3.0-4.0	1.0

• Except for BLM03PG·PX·EB/15AX·PD·PG·PX/18PG·KG·SG/21PG. And BLM02/03/15/18G is specially adapted for reflow soldering.

BLE32PN·BLM□□AX/P/K/S/E

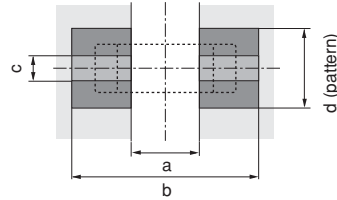

Type	Rated Current (A)	Soldering	a	b	c	Land Pad Thickness and Dimension d		
						18μm	35μm	70μm
<b>BLE32PN</b>	10	Flow/ Reflow	1.9	3.6	2.7	-	4.0 (Temperature 85°C or less)	-
						-	8.0 (Temperature 125°C or less)	-
<b>BLM03AX</b>	0.9max.	Reflow	0.2-0.3	0.6-0.9	0.3	0.3	0.3	0.3
<b>BLM03P□</b>	1.8max.					1.2	0.7	0.3
<b>BLM03EB</b>	1.5max.	Reflow	0.4	1.2-1.4	0.5	0.5	0.5	0.5
<b>BLM15AX</b>	2.2max.					1.2	0.7	0.5
<b>BLM15PD</b>	3.0max.					2.4	1.2	0.5
<b>BLM15PG</b>								
<b>BLM15PX</b>								
<b>BLM18PG</b>	0.5-1.5	Flow/ Reflow	0.7	Flow 2.2-2.6 Reflow 1.8-2.0	0.7	0.7	0.7	0.7
	1.7-2.5					1.2	0.7	0.7
	3-4					2.4	1.2	0.7
	5-6					6.4	3.3	1.65
<b>BLM21PG</b>	1.5	Flow/ Reflow	1.2	3.0-4.0	1.0	1.0	1.0	1.0
	2					1.2	1.0	1.0
	3-4					2.4	1.2	1.0
	6					6.4	3.3	1.65
<b>BLM31PG</b>	1.5-2	Flow/ Reflow	2.0	4.2-5.2	1.2	1.2	1.2	1.2
	3.5					2.4	1.2	1.2
	6					6.4	3.3	1.65
<b>BLM41PG</b>	1.5-2	Flow/ Reflow	3.0	5.5-6.5	1.2	1.2	1.2	1.2
	3.5					2.4	1.2	1.2
	6					6.4	3.3	1.65

• About land pad thickness of BLE32PN, please note the upper limit of the temperature.  
 • Do not apply narrower pattern than listed above to BLM□□AX/P/K/S. Narrow pattern can cause excessive heat or open circuit.

**BLA2A**  
**BLA31**

●Reflow Soldering  
BLA2A

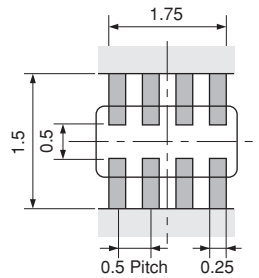

●Reflow and Flow  
BLA31

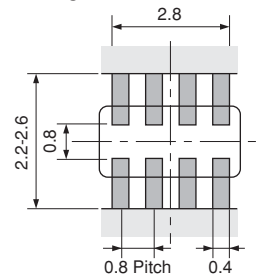

• If there are high amounts of self-heating on pattern, the contact points of PCB and part may become damaged.

⚠Note • Please read rating and ⚠CAUTION (for storage, operating, rating, soldering, mounting and handling) in this catalog to prevent smoking and/or burning, etc.  
 • This catalog has only typical specifications. Therefore, please approve our product specifications or transact the approval sheet for product specifications before ordering.

Soldering and Mounting  
 Chip Ferrite Bead  
 Chip EMIFIL®  
 Chip Common Mode Choke Coil  
 Block Type EMIFIL®  
 Microwave Absorber

● PCB Warping

PCB should be designed so that products are not subjected to the mechanical stress caused by warping the board.

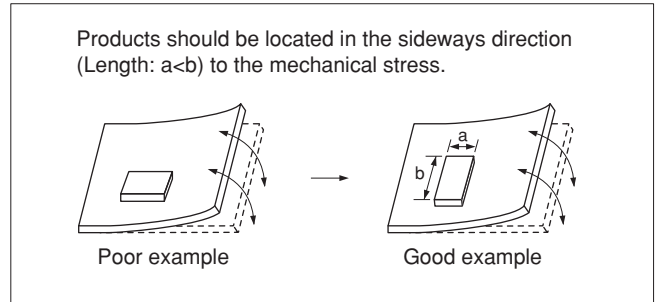

2. Solder Paste Printing and Adhesive Application

When reflow soldering the chip ferrite beads and bead inductor the printing must be conducted in accordance with the following cream solder printing conditions. If too much solder is applied, the chip will be prone to damage by mechanical and thermal stress from the PCB and may crack. Standard land dimensions should be used for resist and copper foil patterns.

When flow soldering the chip ferrite beads and bead inductor apply the adhesive in accordance with the following conditions. If too much adhesive is applied, then it may overflow into the land or termination areas and yield poor solderability. In contrast, if insufficient adhesive is applied, or if the adhesive is not sufficiently hardened, then the chip may become detached during flow soldering process.

(in mm)

Series	Solder Paste Printing	Adhesive Application
BLM BLE	<ul style="list-style-type: none"> <li>● Ensure that solder is applied smoothly to a minimum height of 0.2mm to 0.3mm at the end surface of the part.</li> <li>● Guideline of solder paste thickness: 50-80μm: BLM02 100-150μm: BLM03 100-200μm: BLM15/18/21/31/41/BLE32</li> </ul>	<ul style="list-style-type: none"> <li>■ BLM18/21/31/41 Series (Except for BLM18G Series) Coating amount is illustrated in the following diagram.</li> </ul> <p>a: 20-70μm b: 30-35μm c: 50-105μm</p>
BLA	<ul style="list-style-type: none"> <li>● Guideline of solder paste thickness: 100-150μm: BLA2A 150-200μm: BLA31</li> </ul>	<ul style="list-style-type: none"> <li>■ BLA31 Series Coating amount is illustrated in the following diagram.</li> </ul> <p>a: 20-70μm b: 30-35μm c: 50-105μm</p>

⚠Note • Please read rating and ⚠CAUTION (for storage, operating, rating, soldering, mounting and handling) in this catalog to prevent smoking and/or burning, etc.  
• This catalog has only typical specifications. Therefore, please approve our product specifications or transact the approval sheet for product specifications before ordering.

**3. Standard Soldering Conditions**

(1) Soldering Methods

Use flow and reflow soldering methods only.  
 Use standard soldering conditions when soldering chip ferrite beads and bead inductor.  
 In cases where several different parts are soldered, each having different soldering conditions, use those conditions requiring the least heat and minimum time.

Solder: Use Sn-3.0Ag-0.5Cu solder. Use of Sn-Zn based solder will deteriorate performance of products.  
 If using BLA series with Sn-Zn based solder, please contact Murata in advance.

Flux:

- Use Rosin-based flux.  
 In case of using RA type solder, products should be cleaned completely with no residual flux.
- Do not use strong acidic flux (with chlorine content exceeding 0.20wt%)
- Do not use water-soluble flux.

For additional mounting methods, please contact Murata.

(2) Soldering Profile

● Flow Soldering Profile  
 ( Sn-3.0Ag-0.5Cu Solder)

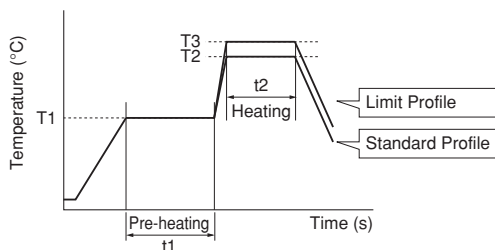

Series	Pre-heating		Standard Profile			Limit Profile		
	Temp. (T1)	Time. (t1)	Heating		Cycle of Flow	Heating		Cycle of Flow
			Temp. (T2)	Time. (t2)		Temp. (T3)	Time. (t2)	
<b>BLM</b> (Except for <b>BLM02/03/15/18G</b> ) <b>BLE</b> <b>BLA31</b>	150°C	60s min.	250°C	4 to 6s	2 times max.	265±3°C	5s max.	2 times max.

● Reflow Soldering Profile  
 (Sn-3.0Ag-0.5Cu Solder)

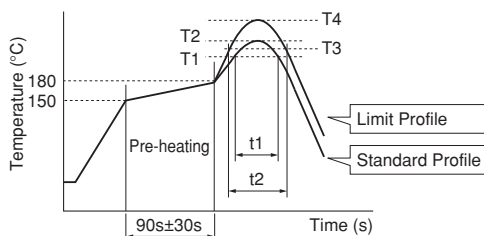

Series	Standard Profile				Limit Profile			
	Heating		Peak Temperature (T2)	Cycle of Reflow	Heating		Peak Temperature (T4)	Cycle of Reflow
	Temp. (T1)	Time. (t1)			Temp. (T3)	Time. (t2)		
<b>BLM</b> <b>BLE</b> <b>BLA</b>	220°C min.	30 to 60s	245±3°C	2 times max.	230°C min.	60s max.	260°C/10s	2 times max.

△Note • Please read rating and △CAUTION (for storage, operating, rating, soldering, mounting and handling) in this catalog to prevent smoking and/or burning, etc.  
 • This catalog has only typical specifications. Therefore, please approve our product specifications or transact the approval sheet for product specifications before ordering.

Soldering and Mounting  
Chip Ferrite Bead

Chip EMIFIL®

Chip Common Mode Choke Coil

Block Type EMIFIL®

Microwave Absorber



## (3) Reworking with Solder Iron

The following conditions must be strictly followed when using a soldering iron. (Except for BLM02 Series)

Pre-heating: 150°C 60s min.

Soldering iron power output / Tip diameter:

80W max. / ø3mm max.

Temperature of soldering iron tip / Soldering time / Times:  
350°C max. / 3-4s / 2 times

Do not allow the tip of the soldering iron to directly contact the chip.

For additional methods of reworking with a soldering iron, please contact Murata engineering.

#### 4. Cleaning

Following conditions should be observed when cleaning chip ferrite beads.

(1) Cleaning Temperature: 60°C max. (40°C max. for alcohol type cleaner)

(2) Ultrasonic

Output: 20W/liter max.

Duration: 5 minutes max.

Frequency: 28 to 40kHz

(3) Cleaning Agent

The following list of cleaning agents have been tested on the individual components. Evaluation of final assembly should be completed prior to production.

(a) Alcohol cleaning agent

Isopropyl alcohol (IPA)

(b) Aqueous cleaning agent

Pine Alpha ST-100S

(4) Ensure that flux residue is completely removed.

Component should be thoroughly dried after aqueous agent has been removed with deionized water.

(5) BLM\_G type is processed with resin. On rinsing the product, using water for ultrasonic cleaning may affect the resin quality used for the product by water element. In case of set cleaning conditions, please make sure the reliability according to the cleaning conditions.

⚠Note • Please read rating and ⚠CAUTION (for storage, operating, rating, soldering, mounting and handling) in this catalog to prevent smoking and/or burning, etc.  
• This catalog has only typical specifications. Therefore, please approve our product specifications or transact the approval sheet for product specifications before ordering.

## ■ Minimum Quantity and Dimensions of 8mm Width Paper / Embossed Tape

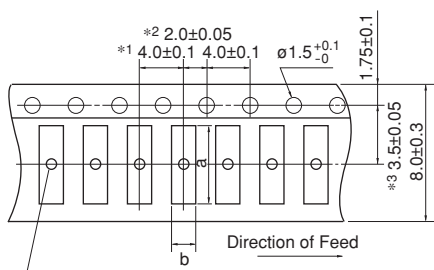

<Embossed>

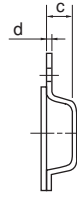

c: Depth of Cavity (Embossed Tape)

<Paper>

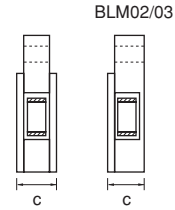

c: Total Thickness of Tape (Paper Tape)

There are holes in the cavities of the BLM21BD222SN1/BD272SN1 and BLM31 only.  $\phi 1.0 +0.3 -0$ . BLE32 only.  $\phi 1.0 +0.2 -0$ .

- \*1 BLM02/03/15:  $2.0 \pm 0.05$   
BLM18S/18T/BLA2A:  $2.0 \pm 0.1$
- \*2 BLA2A/31:  $2.0 \pm 0.1$
- \*3 BLA2A/31:  $3.5 \pm 0.1$

Dimension of the cavity of embossed tape is measured at the bottom side.

Part Number	Dimensions				Minimum Qty. (pcs.)				Bulk
					ø180mm Reel		ø330mm Reel		
	a	b	c	d	Paper Tape	Embossed Tape	Paper Tape	Embossed Tape	
BLM02	0.45	0.25	0.40 max.	-	20000	-	-	-	1000
BLM03	0.70	0.40	0.55 max.	-	15000	-	50000	-	1000
BLM15	1.15	0.65	0.8 max.	-	10000	-	50000	-	1000
BLM18A/B/P/R/H/G	1.85	1.05	1.1 max.	-	4000	-	10000	-	1000
BLM18EG/KG_TN	1.85	1.05	0.85 max.	-	4000	-	10000	-	1000
BLM18EG/KG_SN			1.1 max.						
BLM18S	1.85	1.05	0.90 max.	-	10000	-	30000	-	1000
BLM18T	1.85	1.05	0.90 max.	-	10000	-	-	-	1000
BLM21	2.25	1.45	1.1 max.	-	4000	-	10000	-	1000
BLM31	3.5	1.9	1.3	0.2	-	3000	-	10000	1000
BLM21BD222SN1/272SN1	2.25	1.45	1.3	0.2	-	3000	-	10000	1000
BLE32	3.2	2.8	2.3	0.25	-	1500	-	7000	1000
BLA2A	2.2	1.2	0.8 max.	-	10000	-	50000	-	1000
BLA31	3.4	1.8	1.1 max.	-	4000	-	10000	-	1000

(in mm)

## ■ Minimum Quantity and Dimensions of 12mm Width Embossed Tape

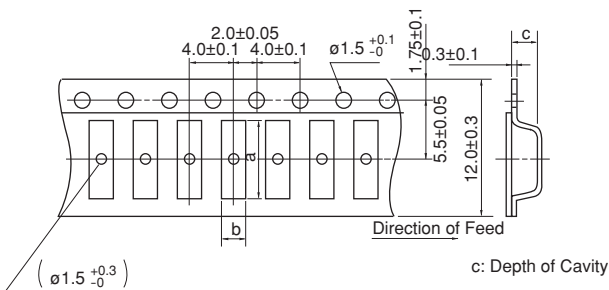

Part Number	Dimensions			Minimum Qty. (pcs.)		
	a	b	c	ø180mm Reel	ø330mm Reel	Bulk
BLM41	4.8	1.9	1.75	2500	8000	1000

Dimension of the cavity is measured at the bottom side.

(in mm)

"Minimum Quantity" means the number of units of each delivery or order. The quantity should be an integral multiple of the "Minimum Quantity."

△Note • Please read rating and △CAUTION (for storage, operating, rating, soldering, mounting and handling) in this catalog to prevent smoking and/or burning, etc.  
• This catalog has only typical specifications. Therefore, please approve our product specifications or transact the approval sheet for product specifications before ordering.

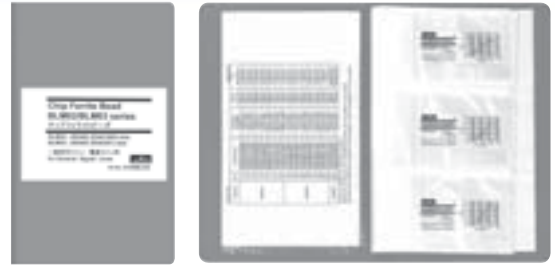

●EKEMBL03AL-KIT (Chip Ferrite Beads)

No.	Part Number	Quantity (pcs.)	Impedance typ. (at 100MHz, 20 degrees C)	Rated Current (mA)	DC Resistance (Ω) max.
1	BLM02AX100SN1	20	10Ω±5Ω	750	0.07
2	BLM02AX700SN1	20	70Ω±25%	300	0.4
3	BLM02AX121SN1	20	120Ω±25%	250	0.5
4	BLM03AG100SN1	20	10Ω (Typ.)	500	0.1
5	BLM03AG700SN1	20	70Ω (Typ.)	200	0.4
6	BLM03AG800SN1	20	80Ω±25%	200	0.4
7	BLM03AG121SN1	20	120Ω±25%	200	0.5
8	BLM03AG241SN1	20	240Ω±25%	200	0.8
9	BLM03AG601SN1	20	600Ω±25%	100	1.5
10	BLM03AG102SN1	20	1000Ω±25%	100	2.5
11	BLM03AX100SN1	20	10Ω (Typ.)	1000	0.05
12	BLM03AX800SN1	20	80Ω±25%	500	0.18
13	BLM03AX121SN1	20	120Ω±25%	450	0.23
14	BLM03AX241SN1	20	240Ω±25%	350	0.38
15	BLM03AX601SN1	20	600Ω±25%	250	0.85
16	BLM03AX102SN1	20	1000Ω±25%	200	1.25
17	BLM03BB100SN1	20	10Ω±25%	300	0.4
18	BLM03BB220SN1	20	22Ω±25%	200	0.5
19	BLM03BB470SN1	20	47Ω±25%	200	0.7
20	BLM03BB750SN1	20	75Ω±25%	200	1.0
21	BLM03BB121SN1	20	120Ω±25%	100	1.5
22	BLM03BD750SN1	20	75Ω±25%	300	0.4
23	BLM03BD121SN1	20	120Ω±25%	250	0.5
24	BLM03BD241SN1	20	240Ω±25%	200	0.8
25	BLM03BD471SN1	20	470Ω±25%	215	1.5
26	BLM03BD601SN1	20	600Ω±25%	200	1.7
27	BLM03BC330SN1	20	33Ω±25%	150	0.85
28	BLM03BC560SN1	20	56Ω±25%	100	1.05
29	BLM03BC800SN1	20	80Ω±25%	100	1.40
30	BLM03EB250SN1	20	25Ω±25%	600	0.26
31	BLM03EB500SN1	20	50Ω±25%	400	0.58
32	BLM03HG601SN1	20	600Ω±25%	150	1.6
33	BLM03HG102SN1	20	1000Ω±25%	125	2.6
34	BLM03HB191SN1	20	190Ω±25%	150	2.0
35	BLM03HD331SN1	20	330Ω±25%	200	1.0
36	BLM03HD471SN1	20	470Ω±25%	175	1.3
37	BLM03HD601SN1	20	600Ω±25%	150	1.7
38	BLM03HD102SN1	20	1000Ω±25%	120	2.9
39	BLM03PG220SN1	20	22Ω±25%	900	0.065
40	BLM03PG330SN1	20	33Ω±25%	750	0.090
41	BLM03PX220SN1	20	22Ω±25%	1800	0.040
42	BLM03PX330SN1	20	33Ω±25%	1500	0.055
43	BLM03PX800SN1	20	80Ω±25%	1000	0.130

●EKEMBL15AR-KIT (Chip Ferrite Beads)

No.	Part Number	Quantity (pcs.)	Impedance typ. (at 100MHz, 20 degrees C)	Rated Current (mA)	DC Resistance (Ω) max.
1	BLM15AG100SN1	20	10Ω (Typ.)	1000	0.025
2	BLM15AG700SN1	20	70Ω (Typ.)	600	0.15
3	BLM15AG121SN1	20	120Ω±25%	550	0.19
4	BLM15AG221SN1	20	220Ω±25%	450	0.29
5	BLM15AG601SN1	20	600Ω±25%	300	0.52
6	BLM15AG102SN1	20	1000Ω±25%	300	0.65
7	BLM15AX100SN1	20	10Ω±5Ω	1740	0.015
8	BLM15AX300SN1	20	30Ω±25%	1100	0.06

Continued on the following page.

⚠Note • Please read rating and ⚠CAUTION (for storage, operating, rating, soldering, mounting and handling) in this catalog to prevent smoking and/or burning, etc.  
 • This catalog has only typical specifications. Therefore, please approve our product specifications or transact the approval sheet for product specifications before ordering.

Continued from the preceding page.

No.	Part Number	Quantity (pcs.)	Impedance typ. (at 100MHz, 20 degrees C)	Rated Current (mA)	DC Resistance (Ω) max.
9	BLM15AX700SN1	20	70Ω±25%	780	0.10
10	BLM15AX121SN1	20	120Ω±25%	700	0.13
11	BLM15AX221SN1	20	220Ω±25%	600	0.18
12	BLM15AX601SN1	20	600Ω±25%	500	0.34
13	BLM15AX102SN1	20	1000Ω±25%	350	0.49
14	BLM15BA050SN1	20	5Ω±25%	300	0.10
15	BLM15BA100SN1	20	10Ω±25%	300	0.20
16	BLM15BA220SN1	20	22Ω±25%	300	0.30
17	BLM15BA330SN1	20	33Ω±25%	300	0.40
18	BLM15BA470SN1	20	47Ω±25%	200	0.60
19	BLM15BA750SN1	20	75Ω±25%	200	0.80
20	BLM15BB050SN1	20	5Ω±25%	500	0.08
21	BLM15BB100SN1	20	10Ω±25%	300	0.10
22	BLM15BB220SN1	20	22Ω±25%	300	0.20
23	BLM15BB470SN1	20	47Ω±25%	300	0.35
24	BLM15BB750SN1	20	75Ω±25%	300	0.40
25	BLM15BB121SN1	20	120Ω±25%	300	0.55
26	BLM15BB221SN1	20	220Ω±25%	200	0.80
27	BLM15BC121SN1	20	120Ω±25%	350	0.45
28	BLM15BC241SN1	20	240Ω±25%	250	0.70
29	BLM15BD750SN1	20	75Ω±25%	300	0.20
30	BLM15BD121SN1	20	120Ω±25%	300	0.30
31	BLM15BD221SN1	20	220Ω±25%	300	0.40
32	BLM15BD471SN1	20	470Ω±25%	200	0.60
33	BLM15BD601SN1	20	600Ω±25%	200	0.65
34	BLM15BD102SN1	20	1000Ω±25%	200	0.90
35	BLM15BD182SN1	20	1800Ω±25%	100	1.40
36	BLM15BX750SN1	20	75Ω±25%	600	0.15
37	BLM15BX121SN1	20	120Ω±25%	600	0.17
38	BLM15BX221SN1	20	220Ω±25%	450	0.27
39	BLM15BX471SN1	20	470Ω±25%	350	0.41
40	BLM15BX601SN1	20	600Ω±25%	350	0.46
41	BLM15BX102SN1	20	1000Ω±25%	300	0.65
42	BLM15BX182SN1	20	1800Ω±25%	250	0.90
43	BLM15HD601SN1	20	600Ω±25%	300	0.85
44	BLM15HD102SN1	20	1000Ω±25%	250	1.25
45	BLM15HD182SN1	20	1800Ω±25%	200	2.20
46	BLM15HG601SN1	20	600Ω±25%	300	0.70
47	BLM15HG102SN1	20	1000Ω±25%	250	1.10
48	BLM15HB121SN1	20	120Ω±25%	300	0.70
49	BLM15HB221SN1	20	220Ω±25%	250	1.00
50	BLM15EG121SN1	20	120Ω±25%	1500	0.095
51	BLM15EG221SN1	20	220Ω±25%	700	0.28
52	BLM15GG221SN1	20	220Ω±25%	300	0.70
53	BLM15GG471SN1	20	470Ω±25%	200	1.30
54	BLM15GA750SN1	20	75Ω±25%	200	1.30
55	BLM15PG100SN1	20	10Ω (Typ.)	1000	0.025
56	BLM15PD300SN1	20	30Ω±25%	2200	0.035
57	BLM15PD600SN1	20	60Ω±25%	1700	0.06
58	BLM15PD800SN1	20	80Ω±25%	1500	0.07
59	BLM15PD121SN1	20	120Ω±25%	1300	0.09
60	BLM15PX330SN1	20	33Ω±25%	3000	0.022
61	BLM15PX600SN1	20	60Ω±25%	2500	0.032
62	BLM15PX800SN1	20	80Ω±25%	2300	0.038
63	BLM15PX121SN1	20	120Ω±25%	2000	0.055
64	BLM15PX181SN1	20	180Ω±25%	1500	0.090
65	BLM15PX221SN1	20	220Ω±25%	1400	0.10
66	BLM15PX331SN1	20	330Ω±25%	1200	0.15
67	BLM15PX471SN1	20	470Ω±25%	1000	0.20
68	BLM15PX601SN1	20	600Ω±25%	900	0.23

△Note • Please read rating and △CAUTION (for storage, operating, rating, soldering, mounting and handling) in this catalog to prevent smoking and/or burning, etc.  
 • This catalog has only typical specifications. Therefore, please approve our product specifications or transact the approval sheet for product specifications before ordering.

Design Kits  
Chip Ferrite Bead

Chip EMIFIL®

Chip Common Mode Choke Coil

Block Type EMIFIL®

Microwave Absorber

## ●EKEMBL18AJ-KIT (Chip Ferrite Beads)

No.	Part Number	Quantity (pcs.)	Impedance typ. (at 100MHz, 20 degrees C)	Rated Current (mA)	DC Resistance (Ω) max.
1	BLM18AG121SN1	20	120Ω±25%	500	0.18
2	BLM18AG151SN1	20	150Ω±25%	500	0.25
3	BLM18AG221SN1	20	220Ω±25%	500	0.25
4	BLM18AG331SN1	20	330Ω±25%	500	0.30
5	BLM18AG471SN1	20	470Ω±25%	500	0.35
6	BLM18AG601SN1	20	600Ω±25%	500	0.38
7	BLM18AG102SN1	20	1000Ω±25%	400	0.50
8	BLM18BA050SN1	20	5Ω±25%	500	0.20
9	BLM18BA100SN1	20	10Ω±25%	500	0.25
10	BLM18BA470SN1	20	47Ω±25%	300	0.55
11	BLM18BA750SN1	20	75Ω±25%	300	0.70
12	BLM18BA121SN1	20	120Ω±25%	200	0.90
13	BLM18BB050SN1	20	5Ω±25%	700	0.05
14	BLM18BB100SN1	20	10Ω±25%	700	0.10
15	BLM18BB220SN1	20	22Ω±25%	600	0.20
16	BLM18BB470SN1	20	47Ω±25%	550	0.25
17	BLM18BB600SN1	20	60Ω±25%	550	0.25
18	BLM18BB750SN1	20	75Ω±25%	500	0.30
19	BLM18BB121SN1	20	120Ω±25%	500	0.30
20	BLM18BB151SN1	20	150Ω±25%	450	0.37
21	BLM18BB221SN1	20	220Ω±25%	450	0.45
22	BLM18BB331SN1	20	330Ω±25%	400	0.58
23	BLM18BB471SN1	20	470Ω±25%	300	0.85
24	BLM18BD470SN1	20	47Ω±25%	500	0.30
25	BLM18BD121SN1	20	120Ω±25%	200	0.40
26	BLM18BD151SN1	20	150Ω±25%	200	0.40
27	BLM18BD221SN1	20	220Ω±25%	200	0.45
28	BLM18BD331SN1	20	330Ω±25%	200	0.50
29	BLM18BD421SN1	20	420Ω±25%	200	0.55
30	BLM18BD471SN1	20	470Ω±25%	200	0.55
31	BLM18BD601SN1	20	600Ω±25%	200	0.65
32	BLM18BD102SN1	20	1000Ω±25%	100	0.85
33	BLM18BD152SN1	20	1500Ω±25%	50	1.20
34	BLM18BD182SN1	20	1800Ω±25%	50	1.50
35	BLM18BD222SN1	20	2200Ω±25%	50	1.50
36	BLM18BD252SN1	20	2500Ω±25%	50	1.50
37	BLM18PG300SN1	20	30Ω (Typ.)	1000	0.05
38	BLM18PG330SN1	20	33Ω±25%	3000	0.025
39	BLM18PG600SN1	20	60Ω (Typ.)	500	0.10
40	BLM18PG121SN1	20	120Ω±25%	2000	0.05
41	BLM18PG181SN1	20	180Ω±25%	1500	0.09
42	BLM18PG221SN1	20	220Ω±25%	1400	0.10
43	BLM18PG331SN1	20	330Ω±25%	1200	0.15
44	BLM18PG471SN1	20	470Ω±25%	1000	0.20
45	BLM18KG260TN1	20	26Ω±25%	6000	0.007
46	BLM18KG300TN1	20	30Ω±25%	5000	0.010
47	BLM18KG700TN1	20	70Ω±25%	3500	0.022
48	BLM18KG101TN1	20	100Ω±25%	3000	0.030
49	BLM18KG121TN1	20	120Ω±25%	3000	0.030
50	BLM18KG221SN1	20	220Ω±25%	2200	0.050
51	BLM18KG331SN1	20	330Ω±25%	1700	0.080
52	BLM18KG471SN1	20	470Ω±25%	1500	0.130
53	BLM18KG601SN1	20	600Ω±25%	1300	0.150
54	BLM18SG260TN1	20	26Ω±25%	6000	0.007
55	BLM18SG700TN1	20	70Ω±25%	4000	0.020
56	BLM18SG121TN1	20	120Ω±25%	3000	0.025
57	BLM18SG221TN1	20	220Ω±25%	2500	0.040
58	BLM18SG331TN1	20	330Ω±25%	1500	0.070

## ●EKEMBL8GAB-KIT (Chip Ferrite Beads / for High Frequency Type)

No.	Part Number	Quantity (pcs.)	Impedance (at 100MHz, 20 degrees C)	Impedance (at 1GHz, 20 degrees C)	Rated Current (mA)	DC Resistance (Ω) max.
1	BLM18HG471SN1	20	470Ω±25%	600Ω (Typ.)	200	0.85
2	BLM18HG601SN1	20	600Ω±25%	700Ω (Typ.)	200	1.00
3	BLM18HG102SN1	20	1000Ω±25%	1000Ω (Typ.)	100	1.60

Continued on the following page. 

⚠Note • Please read rating and ⚠CAUTION (for storage, operating, rating, soldering, mounting and handling) in this catalog to prevent smoking and/or burning, etc.  
 • This catalog has only typical specifications. Therefore, please approve our product specifications or transact the approval sheet for product specifications before ordering.

Continued from the preceding page.

No.	Part Number	Quantity (pcs.)	Impedance (at 100MHz, 20 degrees C)	Impedance (at 1GHz, 20 degrees C)	Rated Current (mA)	DC Resistance (Ω) max.
4	BLM18HB121SN1	20	120Ω±25%	500Ω±40%	200	0.50
5	BLM18HB221SN1	20	220Ω±25%	1100Ω±40%	100	0.80
6	BLM18HB331SN1	20	330Ω±25%	1600Ω±40%	50	1.20
7	BLM18HD471SN1	20	470Ω±25%	1000Ω (Typ.)	100	1.20
8	BLM18HD601SN1	20	600Ω±25%	1200Ω (Typ.)	100	1.50
9	BLM18HD102SN1	20	1000Ω±25%	1700Ω (Typ.)	50	1.80
10	BLM18HE601SN1	20	600Ω±25%	600Ω (Typ.)	800	0.25
11	BLM18HE102SN1	20	1000Ω±25%	1000Ω (Typ.)	600	0.35
12	BLM18HE152SN1	20	1500Ω±25%	1500Ω (Typ.)	500	0.50
13	BLM18HK331SN1	20	330Ω±25%	400Ω (Typ.)	200	0.50
14	BLM18HK471SN1	20	470Ω±25%	600Ω (Typ.)	200	0.70
15	BLM18HK601SN1	20	600Ω±25%	700Ω (Typ.)	100	0.90
16	BLM18HK102SN1	20	1000Ω±25%	1200Ω (Typ.)	50	1.50
17	BLM18EG101TN1	20	100Ω±25%	140Ω (Typ.)	2000	0.045
18	BLM18EG121SN1	20	120Ω±25%	145Ω (Typ.)	2000	0.04
19	BLM18EG221TN1	20	220Ω±25%	300Ω (Typ.)	1000	0.15
20	BLM18EG221SN1	20	220Ω±25%	260Ω (Typ.)	2000	0.05
21	BLM18EG331TN1	20	330Ω±25%	450Ω (Typ.)	500	0.21
22	BLM18EG391TN1	20	390Ω±25%	520Ω (Typ.)	500	0.30
23	BLM18EG471SN1	20	470Ω±25%	550Ω (Typ.)	500	0.21
24	BLM18EG601SN1	20	600Ω±25%	700Ω (Typ.)	500	0.35
25	BLM18GG471SN1	20	470Ω±25%	1800Ω±30%	200	1.30

●EKEMBL21AF-KIT (Chip Ferrite Beads / for Large-current P Type)

No.	Part Number	Quantity (pcs.)	Impedance typ. (at 100MHz, 20 degrees C)	Rated Current (mA)	DC Resistance (Ω) max.
1	BLM21AG121SN1	20	120Ω±25%	800	0.10
2	BLM21AG151SN1	20	150Ω±25%	800	0.10
3	BLM21AG221SN1	20	220Ω±25%	800	0.13
4	BLM21AG331SN1	20	330Ω±25%	700	0.16
5	BLM21AG471SN1	20	470Ω±25%	700	0.19
6	BLM21AG601SN1	20	600Ω±25%	600	0.21
7	BLM21AG102SN1	20	1000Ω±25%	500	0.28
8	BLM21BB050SN1	20	5Ω±25%	1000	0.02
9	BLM21BB600SN1	20	60Ω±25%	800	0.13
10	BLM21BB750SN1	20	75Ω±25%	700	0.16
11	BLM21BB121SN1	20	120Ω±25%	600	0.19
12	BLM21BB221SN1	20	220Ω±25%	500	0.26
13	BLM21BB331SN1	20	330Ω±25%	400	0.33
14	BLM21BB471SN1	20	470Ω±25%	400	0.40
15	BLM21BD121SN1	20	120Ω±25%	200	0.25
16	BLM21BD221SN1	20	220Ω±25%	200	0.25
17	BLM21BD421SN1	20	420Ω±25%	200	0.30
18	BLM21BD471SN1	20	470Ω±25%	200	0.35
19	BLM21BD601SN1	20	600Ω±25%	200	0.35
20	BLM21BD102SN1	20	1000Ω±25%	200	0.40
21	BLM21BD152SN1	20	1500Ω±25%	200	0.45
22	BLM21BD182SN1	20	1800Ω±25%	200	0.50
23	BLM21BD222SN1	20	2250Ω (Typ.)	200	0.60
24	BLM21BD222TN1	20	2200Ω±25%	200	0.60
25	BLM21BD272SN1	20	2700Ω±25%	200	0.80
26	BLM21PG220SN1	20	22Ω±25%	6000	0.009
27	BLM21PG300SN1	20	30Ω (Typ.)	4000	0.014
28	BLM21PG600SN1	20	60Ω±25%	3500	0.02
29	BLM21PG121SN1	20	120Ω±25%	3000	0.03
30	BLM21PG221SN1	20	220Ω±25%	2000	0.045
31	BLM21PG331SN1	20	330Ω±25%	1500	0.07
32	BLM31PG330SN1	20	33Ω±25%	6000	0.009
33	BLM31PG500SN1	20	50Ω (Typ.)	3500	0.015
34	BLM31PG121SN1	20	120Ω±25%	3500	0.02
35	BLM31PG391SN1	20	390Ω±25%	2000	0.05
36	BLM31PG601SN1	20	600Ω±25%	1500	0.08
37	BLM41PG600SN1	20	60Ω (Typ.)	6000	0.009
38	BLM41PG750SN1	20	75Ω (Typ.)	3500	0.015
39	BLM41PG181SN1	20	180Ω±25%	3500	0.02

Continued on the following page.

**Note** • Please read rating and **CAUTION** (for storage, operating, rating, soldering, mounting and handling) in this catalog to prevent smoking and/or burning, etc.  
 • This catalog has only typical specifications. Therefore, please approve our product specifications or transact the approval sheet for product specifications before ordering.

Design Kits  
Chip Ferrite Bead

Chip EMIFIL®

Chip Common Mode Choke Coil

Block Type EMIFIL®

Microwave Absorber

Continued from the preceding page.

No.	Part Number	Quantity (pcs.)	Impedance typ. (at 100MHz, 20 degrees C)	Rated Current (mA)	DC Resistance (Ω) max.
40	<b>BLM41PG471SN1</b>	20	470Ω±25%	2000	0.05
41	<b>BLM41PG102SN1</b>	20	1000Ω±25%	1500	0.09

⚠Note • Please read rating and ⚠CAUTION (for storage, operating, rating, soldering, mounting and handling) in this catalog to prevent smoking and/or burning, etc.  
 • This catalog has only typical specifications. Therefore, please approve our product specifications or transact the approval sheet for product specifications before ordering.

# Memo

---

⚠Note • Please read rating and ⚠CAUTION (for storage, operating, rating, soldering, mounting and handling) in this catalog to prevent smoking and/or burning, etc.  
• This catalog has only typical specifications. Therefore, please approve our product specifications or transact the approval sheet for product specifications before ordering.



# NF<sub>□</sub>

## Chip EMIFIL<sup>®</sup>

Series Introduction .....	112
Part Numbering .....	114
Series Line Up .....	117
Product Detail .....	121
⚠Caution/Notice .....	154
Soldering and Mounting .....	156
Packaging .....	163
Design Kits .....	165

Chip Ferrite Bead

Chip EMIFIL<sup>®</sup>

Chip Common Mode Choke Coil

Block Type EMIFIL<sup>®</sup>

Microwave Absorber

⚠Note • Please read rating and ⚠CAUTION (for storage, operating, rating, soldering, mounting and handling) in this catalog to prevent smoking and/or burning, etc.  
• This catalog has only typical specifications. Therefore, please approve our product specifications or transact the approval sheet for product specifications before ordering.

# NF□ Series Introduction

Chip Ferrite Bead

Chip EMIFIL®

Chip Common Mode Choke Coil

Block Type EMIFIL®

Microwave Absorber

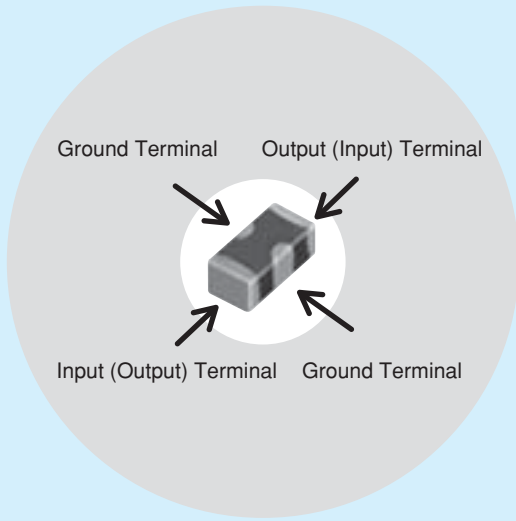

## Example of 3-Terminal Capacitor Structure

Chip 3-terminal capacitor is a chip-shaped 3-terminal capacitor designed for noise suppression. Its inner structure, like a feed-through capacitor, makes its ground impedance quite low. Owing to this structure, the 3-terminal capacitor has a good noise suppression effect at a high frequency range up to several hundred MHz.

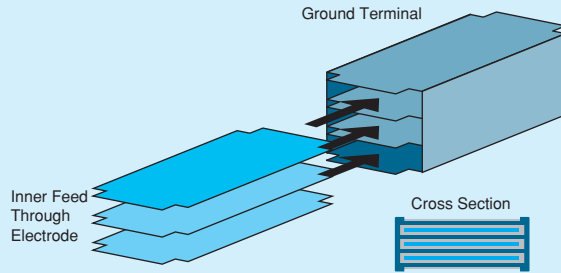

Series	Equivalent Circuit	Part Number
<b>NFM Series</b> (3-terminal capacitor)		<b>NFM18CC</b>
		<b>NFM21CC</b>
		<b>NFM18PC</b>
		<b>NFM18PS</b>
		<b>NFM21PC</b>
<b>NFL / NFW Series</b> (LC filter)		<b>NFL15ST</b>
		<b>NFL18ST</b>
		<b>NFL18SP</b> <b>NFL21SP</b> <b>NFW31SP</b>
<b>NFA Series</b> (RC filter)		<b>NFA21SL</b>
		<b>NFA18SL</b>
		<b>NFA18SD</b>
<b>NFR Series</b> (RC filter)		<b>NFR21GD</b>
		<b>NFA31GD</b>
<b>NFE Series</b> (Feed through capacitor with ferrite cores)		<b>NFE31PT</b>
		<b>NFE61PT</b>

△Note • Please read rating and △CAUTION (for storage, operating, rating, soldering, mounting and handling) in this catalog to prevent smoking and/or burning, etc.  
• This catalog has only typical specifications. Therefore, please approve our product specifications or transact the approval sheet for product specifications before ordering.

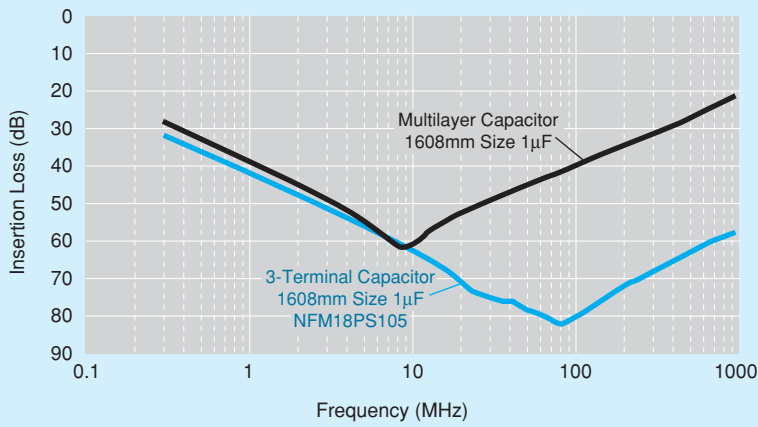

Insertion Loss Sample	Features	Classification		Applications	Example
		Code	Description		
	Standard of 3-terminal capacitor	<b>NFM_CC</b>	Standard type with varied capacitance	Noise suppression in low speed signal lines	· Low speed interface lines · Sensor
		<b>NFM_PC</b>	Meet large current, high capacitance available, for power lines	Noise suppression in power lines	· Individual IC power lines
	Sharp insertion loss curve enables low damage to signal waveform	<b>NFL_ST</b>	T-type filter, effective in low impedance circuits	Noise suppression in high speed signal lines	· High speed interface lines · Bus lines · LCD lines · Camera I/Fs · High speed analog lines · RGB / D terminal
		<b>NFL_SP</b>	$\pi$ -type filter, effective in high impedance circuits		
		<b>NFW_SP</b>	$\pi$ -type filter, designed for low impedance circuits		
		<b>NFA_SL</b>	4-line array, suitable for bus lines or flat cables		
	Limit noise using resistor, also loop back to ground			Noise suppression in signal line with unstable ground	· Interface lines · Clock lines
	Meets large current, good high frequency performance because of its feed through structure			Noise suppression in power lines / low impedance lines	· Various power lines · Sensor

⚠Note • Please read rating and ⚠CAUTION (for storage, operating, rating, soldering, mounting and handling) in this catalog to prevent smoking and/or burning, etc.  
• This catalog has only typical specifications. Therefore, please approve our product specifications or transact the approval sheet for product specifications before ordering.

# NF   Chip EMIFIL<sup>®</sup> Part Numbering

## Capacitor

(Part Number)

<b>NF</b>	<b>M</b>	<b>3D</b>	<b>CC</b>	<b>102</b>	<b>R</b>	<b>1H</b>	<b>3</b>	<b>L</b>
①	②	③	④	⑤	⑥	⑦	⑧	⑨

\*NFA□□SL/SD Series, please refer to p.116 (LC Combined (2)).

\*NFA□□GD Series, please refer to p.116 (RC Combined).

### ① Product ID

Product ID	
<b>NF</b>	Chip EMIFIL <sup>®</sup>

### ② Structure

Code	Structure
<b>M</b>	Capacitor Type
<b>A</b>	Capacitor Array Type

### ③ Dimensions (L×W)

Code	Dimensions (L×W)	EIA
<b>15</b>	1.0×0.5mm	0402
<b>18</b>	1.6×0.8mm	0603
<b>21</b>	2.0×1.25mm	0805
<b>3D</b>	3.2×1.25mm	1205
<b>31</b>	3.2×1.6mm	1206
<b>41</b>	4.5×1.6mm	1806

### ④ Features

Code	Features
<b>CC</b>	Capacitor Type for Signal Lines
<b>PC</b>	Capacitor Type for Large Current
<b>PS</b>	High Insertion Loss Type for Large Current
<b>KC</b>	Capacitor Type for Very Large Current

### ⑤ Capacitance

Expressed by three figures. The unit is in pico-farad (pF). The first and second figures are significant digits, and the third figure expresses the number of zeros that follow the two figures.

### ⑨ Packaging

Code	Packaging	Series
<b>L</b>	Embossed Taping (ø180mm Reel)	<b>NFM3D/NFM31/NFM41</b>
<b>B</b>	Bulk	All series
<b>D</b>	Paper Taping (ø180mm Reel)	<b>NFM15/NFM18/NFM21/NFA□□CC</b>

### ⑥ Characteristics

Code	Capacitance Temperature Characteristics
<b>B</b>	±10%, ±12.5%, +10/-13%
<b>C</b>	±22%
<b>D</b>	+22/-33%
<b>F</b>	+30/-80%, +30/-84%
<b>R</b>	±15%, +15/-18%
<b>U</b>	-750 ±120ppm/°C
<b>S</b>	+350 to -1000ppm/°C

### ⑦ Rated Voltage

Code	Rated Voltage
<b>0E</b>	2.5V
<b>0G</b>	4V
<b>0J</b>	6.3V
<b>1A</b>	10V
<b>1C</b>	16V
<b>1E</b>	25V
<b>1H</b>	50V
<b>2A</b>	100V

### ⑧ Electrode/Others (NFM Series)

Code	Electrode	Series
<b>3</b>	Sn Plating	<b>NFM</b>

### ⑧ Number of Circuits (NFA□□CC Series)

Code	Number of Circuits
<b>4</b>	4 Circuits

△Note • Please read rating and △CAUTION (for storage, operating, rating, soldering, mounting and handling) in this catalog to prevent smoking and/or burning, etc.  
• This catalog has only typical specifications. Therefore, please approve our product specifications or transact the approval sheet for product specifications before ordering.

## LC Combined (1)

(Part Number)

NF	L	18	ST	107	X	1C	3	L
①	②	③	④	⑤	⑥	⑦	⑧	⑨

### ① Product ID

Product ID	
NF	Chip EMIFIL®

### ② Structure

Code	Structure
W	Wire Wound, LC Combined Type
L	Multilayer, LC Combined Type
E	Block, LC Combined Type

### ③ Dimensions (L×W)

Code	Dimensions (L×W)	EIA
15	1.0×0.5mm	0402
18	1.6×0.8mm	0603
21	2.0×1.25mm	0805
31	3.2×1.6mm	1206
61	6.8×1.6mm	2706

### ④ Features

Code	Features
SP	π Circuit for Signal Lines
ST	T Circuit for Signal Lines
PT	T Circuit for Large Current

### ⑤ Cut-off Frequency (NFL/NFW Series)

Expressed by three figures. The unit is in hertz (Hz). The first and second figures are significant digits, and the third figure expresses the number of zeros that follow the two figures.

### ⑤ Capacitance (NFE Series)

Expressed by three figures. The unit is in pico-farad (pF). The first and second figures are significant digits, and the third figure expresses the number of zeros that follow the two figures.

### ⑨ Packaging

Code	Packaging	Series
K	Embossed Taping (ø330mm Reel)	NFW31/NFE
L	Embossed Taping (ø180mm Reel)	NFW31/NFE
B	Bulk	NFL18/NFL21/NFE
D	Paper Taping (ø180mm Reel)	NFL15/NFL18/NFL21

### ⑥ Characteristics (NFL/NFW Series)

Code	Characteristics
H/X	Cut-off Frequency

### ⑥ Characteristics (NFE Series)

Code	Capacitance Temperature Characteristics
B	±10%
C	±20%, ±22%
D	+20/-30%, +22/-33%
E	+20/-55%, +22/-56%
F	+30/-80%, +22/-82%
R	±15%
U	-750 ±120ppm/ °C
Z	Other

### ⑦ Rated Voltage

Code	Rated Voltage
1A	10V
1C	16V
1E	25V
1H	50V
2A	100V

### ⑧ Electrode

Code	Electrode	Series
3/7	Sn Plating	NFL
4	Lead Free Solder Coating	NFW
9	Others	NFE

△Note • Please read rating and △CAUTION (for storage, operating, rating, soldering, mounting and handling) in this catalog to prevent smoking and/or burning, etc.  
• This catalog has only typical specifications. Therefore, please approve our product specifications or transact the approval sheet for product specifications before ordering.

## LC Combined (2)

(Part Number)

NF	A	21	SL	207	X	1A	4	5	L
①	②	③	④	⑤	⑥	⑦	⑧	⑨	⑩

\*NFA□□CC Series, please refer to p.114.

\*NFA□□GD Series, please refer to p.116 (RC Combined).

### ① Product ID

Product ID	
NF	Chip EMIFIL®

### ② Structure

Code	Structure
A	Array Type

### ③ Dimensions (L×W)

Code	Dimensions (L×W)	EIA
18	1.6×0.8mm	0603
21	2.0×1.25mm	0805

### ④ Features (1)

Code	Features
SL	L Circuit for Signal Lines
SD	L Circuit for Differential Signal

### ⑤ Cut-off Frequency

Expressed by three figures. The unit is in hertz (Hz). The first and second figures are significant digits, and the third figure expresses the number of zeros that follow the two figures.

### ⑥ Features (2)

Code	Features
X	Expressed by a letter
V	

### ⑦ Rated Voltage

Code	Rated Voltage
1A	10V

### ⑧ Number of Circuits

Code	Number of Circuits
4	4 Circuits

### ⑨ Dimensions (T)

Code	Dimensions (T)
5	Low Profile
8	Standard

### ⑩ Packaging

Code	Packaging
B	Bulk
L	Embossed Taping (ø180mm Reel)

## RC Combined

(Part Number)

NF	R	21	GD	470	470	2	L
①	②	③	④	⑤	⑥	⑦	⑧

\*NFA□□CC Series, please refer to p.114.

\*NFA□□SL/SD Series, please refer to p.116 (LC Combined (2)).

### ① Product ID

Product ID	
NF	Chip EMIFIL®

### ② Structure

Code	Structure
R	RC Combined Type
A	RC Combined Array Type

### ③ Dimensions (L×W)

Code	Dimensions (L×W)	EIA
21	2.0×1.25mm	0805
31	3.2×1.6mm	1206

### ④ Features

Code	Features
GD	RC Combined Type for Signal Lines

### ⑧ Packaging

Code	Packaging	Series
L	Embossed Taping (ø180mm Reel)	NFR
B	Bulk	All Series
D	Paper Taping (ø180mm Reel)	NFA□□GD

### ⑤ Capacitance

Expressed by three figures. The unit is in pico-farad (pF). The first and second figures are significant digits, and the third figure expresses the number of zeros that follow the two figures.

### ⑥ Resistance

Expressed by three-digit alphanumerics. The unit is in ohm (Ω). The first and second figures are significant digits, and the third figure expresses the number of zeros that follow the two figures. If there is a decimal point, it is expressed by the capital letter "R." In this case, all figures are significant digits.

### ⑦ Electrode/Others (NFR Series)

Code	Electrode
2	Sn Plating

### ⑦ Number of Circuits (NFA□□GD Series)

Code	Number of Circuits
4	4 Circuits

△Note • Please read rating and △CAUTION (for storage, operating, rating, soldering, mounting and handling) in this catalog to prevent smoking and/or burning, etc.  
• This catalog has only typical specifications. Therefore, please approve our product specifications or transact the approval sheet for product specifications before ordering.

Type	Size Code in nch (in mm)	Thickness (mm)	Part Number	Rated Voltage	Capacitance	Nominal Cut-off Frequency	Rated Current	New	Kit	≥1A	≥3A	≥10A	DTV	F <sub>low</sub>	R <sub>ef</sub> F <sub>low</sub>
Capacitor Type for Signal Lines	0402 (1005)	0.4	NFM15CC222D1A3	10Vdc	2200pF+20%-20%	-	1A	New	Kit	≥1A					R <sub>ef</sub> F <sub>low</sub>
			NFM15CC222D1C3	16Vdc	2200pF+20%-20%	-	1A	New	Kit	≥1A					R <sub>ef</sub> F <sub>low</sub>
			NFM15CC223C1A3	10Vdc	22000pF+20%-20%	-	1A	New	Kit	≥1A					R <sub>ef</sub> F <sub>low</sub>
			NFM15CC223C1C3	16Vdc	22000pF+20%-20%	-	1A	New	Kit	≥1A					R <sub>ef</sub> F <sub>low</sub>
	0603 (1608)	0.6	NFM18CC220U1C3	16Vdc	22pF+20%-20%	-	400mA		Kit						R <sub>ef</sub> F <sub>low</sub>
			NFM18CC470U1C3	16Vdc	47pF+20%-20%	-	400mA		Kit						R <sub>ef</sub> F <sub>low</sub>
			NFM18CC101R1C3	16Vdc	100pF+20%-20%	-	500mA		Kit						R <sub>ef</sub> F <sub>low</sub>
			NFM18CC221R1C3	16Vdc	220pF+20%-20%	-	500mA		Kit						R <sub>ef</sub> F <sub>low</sub>
			NFM18CC471R1C3	16Vdc	470pF+20%-20%	-	500mA		Kit						R <sub>ef</sub> F <sub>low</sub>
			NFM18CC102R1C3	16Vdc	1000pF+20%-20%	-	600mA		Kit						R <sub>ef</sub> F <sub>low</sub>
			NFM18CC222R1C3	16Vdc	2200pF+20%-20%	-	700mA		Kit						R <sub>ef</sub> F <sub>low</sub>
			NFM18CC223R1C3	16Vdc	22000pF+20%-20%	-	1000mA		Kit	≥1A					R <sub>ef</sub> F <sub>low</sub>
	0805 (2012)	0.85	NFM21CC220U1H3	50Vdc	22pF+20%-20%	-	700mA		Kit						R <sub>ef</sub> F <sub>low</sub>
			NFM21CC470U1H3	50Vdc	47pF+20%-20%	-	700mA		Kit						R <sub>ef</sub> F <sub>low</sub>
			NFM21CC101U1H3	50Vdc	100pF+20%-20%	-	700mA		Kit						R <sub>ef</sub> F <sub>low</sub>
			NFM21CC221R1H3	50Vdc	220pF+20%-20%	-	700mA		Kit						R <sub>ef</sub> F <sub>low</sub>
			NFM21CC471R1H3	50Vdc	470pF+20%-20%	-	1000mA		Kit	≥1A					R <sub>ef</sub> F <sub>low</sub>
			NFM21CC102R1H3	50Vdc	1000pF+20%-20%	-	1000mA		Kit	≥1A					R <sub>ef</sub> F <sub>low</sub>
			NFM21CC222R1H3	50Vdc	2200pF+20%-20%	-	1000mA		Kit	≥1A					R <sub>ef</sub> F <sub>low</sub>
			NFM21CC223R1H3	50Vdc	22000pF+20%-20%	-	2000mA		Kit	≥1A					R <sub>ef</sub> F <sub>low</sub>
	1205 (3212)	0.7	NFM3DCC220U1H3	50Vdc	22pF+50%-20%	-	300mA							F <sub>low</sub>	R <sub>ef</sub> F <sub>low</sub>
			NFM3DCC470U1H3	50Vdc	47pF+50%-20%	-	300mA							F <sub>low</sub>	R <sub>ef</sub> F <sub>low</sub>
			NFM3DCC101U1H3	50Vdc	100pF+50%-20%	-	300mA							F <sub>low</sub>	R <sub>ef</sub> F <sub>low</sub>
			NFM3DCC221R1H3	50Vdc	220pF+50%-20%	-	300mA							F <sub>low</sub>	R <sub>ef</sub> F <sub>low</sub>
			NFM3DCC471R1H3	50Vdc	470pF+50%-20%	-	300mA							F <sub>low</sub>	R <sub>ef</sub> F <sub>low</sub>
			NFM3DCC102R1H3	50Vdc	1000pF+50%-20%	-	300mA							F <sub>low</sub>	R <sub>ef</sub> F <sub>low</sub>
			NFM3DCC222R1H3	50Vdc	2200pF+50%-20%	-	300mA							F <sub>low</sub>	R <sub>ef</sub> F <sub>low</sub>
			NFM3DCC223R1H3	50Vdc	22000pF+50%-20%	-	300mA							F <sub>low</sub>	R <sub>ef</sub> F <sub>low</sub>
	1806 (4516)	1.0	NFM41CC220U2A3	100Vdc	22pF+50%-20%	-	300mA							F <sub>low</sub>	R <sub>ef</sub> F <sub>low</sub>
			NFM41CC470U2A3	100Vdc	47pF+50%-20%	-	300mA							F <sub>low</sub>	R <sub>ef</sub> F <sub>low</sub>
			NFM41CC101U2A3	100Vdc	100pF+50%-20%	-	300mA							F <sub>low</sub>	R <sub>ef</sub> F <sub>low</sub>
			NFM41CC221U2A3	100Vdc	220pF+50%-20%	-	300mA							F <sub>low</sub>	R <sub>ef</sub> F <sub>low</sub>
NFM41CC471R2A3			100Vdc	470pF+50%-20%	-	300mA							F <sub>low</sub>	R <sub>ef</sub> F <sub>low</sub>	
NFM41CC102R2A3			100Vdc	1000pF+50%-20%	-	300mA							F <sub>low</sub>	R <sub>ef</sub> F <sub>low</sub>	
NFM41CC222R2A3			100Vdc	2200pF+50%-20%	-	300mA							F <sub>low</sub>	R <sub>ef</sub> F <sub>low</sub>	
NFM41CC223R2A3			100Vdc	22000pF+50%-20%	-	300mA							F <sub>low</sub>	R <sub>ef</sub> F <sub>low</sub>	
Capacitor Array Type for Signal Lines	1206 (3216)	0.8	NFA31CC220S1E4	25Vdc	22pF+20%-20%	-	200mA		Kit					R <sub>ef</sub> F <sub>low</sub>	
			NFA31CC470S1E4	25Vdc	47pF+20%-20%	-	200mA		Kit					R <sub>ef</sub> F <sub>low</sub>	
			NFA31CC101S1E4	25Vdc	100pF+20%-20%	-	200mA		Kit					R <sub>ef</sub> F <sub>low</sub>	
			NFA31CC221S1E4	25Vdc	220pF+20%-20%	-	200mA		Kit					R <sub>ef</sub> F <sub>low</sub>	
			NFA31CC471R1E4	25Vdc	470pF+20%-20%	-	200mA		Kit					R <sub>ef</sub> F <sub>low</sub>	
			NFA31CC102R1E4	25Vdc	1000pF+20%-20%	-	200mA		Kit					R <sub>ef</sub> F <sub>low</sub>	
			NFA31CC222R1E4	25Vdc	2200pF+20%-20%	-	200mA		Kit					R <sub>ef</sub> F <sub>low</sub>	
			NFA31CC223R1C4	16Vdc	22000pF+20%-20%	-	200mA		Kit					R <sub>ef</sub> F <sub>low</sub>	

Continued on the following page.

⚠Note • Please read rating and ⚠CAUTION (for storage, operating, rating, soldering, mounting and handling) in this catalog to prevent smoking and/or burning, etc.  
• This catalog has only typical specifications. Therefore, please approve our product specifications or transact the approval sheet for product specifications before ordering.

NF Chip EMIFIL® Series Line Up

Type	Size Code in nch (in mm)	Thickness (mm)	Part Number	Rated Voltage	Capacitance	Nominal Cut-off Frequency	Rated Current	New Kit			Dtv	Flow	ReFlow	
								$\geq 1A$	$\geq 3A$	$\geq 10A$				
Capacitor Type for Power Lines	0402 (1005)	p123	0.4	NFM15PC473C1A3	10Vdc	0.047 $\mu$ F+20%-20%	-	1A	New	Kit	$\geq 1A$		ReFlow	
			0.4	NFM15PC473C1C3	16Vdc	0.047 $\mu$ F+20%-20%	-	1A	New	Kit	$\geq 1A$		ReFlow	
			0.4	NFM15PC104D0J3	6.3Vdc	0.1 $\mu$ F+20%-20%	-	2A	New	Kit	$\geq 1A$		ReFlow	
			0.4	NFM15PC104R1A3	10Vdc	0.1 $\mu$ F+20%-20%	-	2A	New	Kit	$\geq 1A$		ReFlow	
			0.4	NFM15PC224D0J3	6.3Vdc	0.22 $\mu$ F+20%-20%	-	2A	New	Kit	$\geq 1A$		ReFlow	
			0.4	NFM15PC224R1A3	10Vdc	0.22 $\mu$ F+20%-20%	-	2A	New	Kit	$\geq 1A$		ReFlow	
			0.3	NFM15PC474D0G3	4Vdc	0.47 $\mu$ F+20%-20%	-	2A	New	Kit	$\geq 1A$		ReFlow	
			0.3	NFM15PC474R0J3	6.3Vdc	0.47 $\mu$ F+20%-20%	-	2A	New	Kit	$\geq 1A$		ReFlow	
				0.3	NFM15PC105R0G3	4Vdc	1 $\mu$ F+20%-20%	-	2A	New	Kit	$\geq 1A$		ReFlow
				0.4	NFM15PC435R0E3	2.5Vdc	4.3 $\mu$ F+20%-20%	-	2A	New	Kit	$\geq 1A$		ReFlow
		0603 (1608)	p125	0.6	NFM18PS474R0J3	6.3Vdc	0.47 $\mu$ F+20%-20%	-	2A		Kit	$\geq 1A$		ReFlow
	0.6			NFM18PS105D0J3	6.3Vdc	1.0 $\mu$ F+20%-20%	-	2A	New	Kit	$\geq 1A$		ReFlow	
	0.6			NFM18PS105R0J3	6.3Vdc	1.0 $\mu$ F+20%-20%	-	2A		Kit	$\geq 1A$		ReFlow	
		0603 (1608)	p126	0.6	NFM18PC104R1C3	16Vdc	0.1 $\mu$ F+20%-20%	-	2A		Kit	$\geq 1A$		ReFlow
				0.6	NFM18PC224R0J3	6.3Vdc	0.22 $\mu$ F+20%-20%	-	2A		Kit	$\geq 1A$		ReFlow
				0.6	NFM18PC474R0J3	6.3Vdc	0.47 $\mu$ F+20%-20%	-	2A		Kit	$\geq 1A$		ReFlow
				0.8	NFM18PC105R0J3	6.3Vdc	1.0 $\mu$ F+20%-20%	-	4A		Kit	$\geq 1A$		ReFlow
				0.6	NFM18PC225B0J3	6.3Vdc	2.2 $\mu$ F+20%-20%	-	2A		Kit	$\geq 1A$		ReFlow
				0.8	NFM18PC225B1A3	10Vdc	2.2 $\mu$ F+20%-20%	-	4A		Kit	$\geq 3A$		ReFlow
		0805 (2012)	p128	0.85	NFM21PS106B0J3	6.3Vdc	10 $\mu$ F+20%-20%	-	4A		Kit	$\geq 3A$		ReFlow
				0.85	NFM21PC104R1E3	25Vdc	0.1 $\mu$ F+20%-20%	-	2A		Kit	$\geq 1A$		ReFlow
			p129	0.85	NFM21PC224R1C3	16Vdc	0.22 $\mu$ F+20%-20%	-	2A		Kit	$\geq 1A$		ReFlow
				0.85	NFM21PC474R1C3	16Vdc	0.47 $\mu$ F+20%-20%	-	2A		Kit	$\geq 1A$		ReFlow
				0.85	NFM21PC105B1A3	10Vdc	1.0 $\mu$ F+20%-20%	-	4A		Kit	$\geq 3A$		ReFlow
				0.85	NFM21PC105B1C3	16Vdc	1.0 $\mu$ F+20%-20%	-	4A		Kit	$\geq 3A$		ReFlow
				0.85	NFM21PC225B0J3	6.3Vdc	2.2 $\mu$ F+20%-20%	-	4A		Kit	$\geq 3A$		ReFlow
				0.85	NFM21PC475B1A3	10Vdc	4.7 $\mu$ F+20%-20%	-	6A		Kit	$\geq 3A$		ReFlow
		1206 (3216)	1205 (3212)	p130	0.7	NFM3DPC223R1H3	50Vdc	0.022 $\mu$ F+20%-20%	-	2A		$\geq 1A$		Flow ReFlow
	p131			1.3	NFM31PC276B0J3	6.3Vdc	27 $\mu$ F+20%-20%	-	6A		Kit	$\geq 3A$		Flow ReFlow
	p132		1.3	NFM31KC103R1H3	50Vdc	10000pF+20%-20%	-	10A		Kit	$\geq 10A$		Flow ReFlow	
			1.3	NFM31KC103R2A3	100Vdc	10000pF+20%-20%	-	10A		Kit	$\geq 10A$		Flow ReFlow	
			1.3	NFM31KC153R1H3	50Vdc	15000pF+20%-20%	-	10A		Kit	$\geq 10A$		Flow ReFlow	
			1.3	NFM31KC153R2A3	100Vdc	15000pF+20%-20%	-	10A		Kit	$\geq 10A$		Flow ReFlow	
			1.3	NFM31KC223R1H3	50Vdc	22000pF+20%-20%	-	10A		Kit	$\geq 10A$		Flow ReFlow	
			1.3	NFM31KC223R2A3	100Vdc	22000pF+20%-20%	-	10A		Kit	$\geq 10A$		Flow ReFlow	
			1.3	NFM31KC104R1H3	50Vdc	100000pF+20%-20%	-	6A		Kit	$\geq 3A$		Flow ReFlow	
			1.3	NFM31KC104R2A3	100Vdc	100000pF+20%-20%	-	6A		Kit	$\geq 3A$		Flow ReFlow	
	1806 (4516)	p133	1.0	NFM41PC204F1H3	50Vdc	0.2 $\mu$ F+80%-20%	-	2A		Kit	$\geq 1A$		Flow ReFlow	
			1.0	NFM41PC155B1E3	25Vdc	1.5 $\mu$ F+20%-20%	-	6A		Kit	$\geq 3A$		Flow ReFlow	
			1.0	NFM41PC155B1H3	50Vdc	1.5 $\mu$ F+20%-20%	-	6A	New		$\geq 3A$		Flow ReFlow	
	1206 (3216)	p121	1.6	NFE31PT220R1E9	25Vdc	22pF+30%-30%	-	6A			$\geq 3A$		ReFlow	
			1.6	NFE31PT470C1E9	25Vdc	47pF+50%-20%	-	6A			$\geq 3A$		ReFlow	
			1.6	NFE31PT101C1E9	25Vdc	100pF+80%-20%	-	6A			$\geq 3A$		ReFlow	
			1.6	NFE31PT221D1E9	25Vdc	220pF+50%-20%	-	6A			$\geq 3A$		ReFlow	
			1.6	NFE31PT471F1E9	25Vdc	470pF+50%-20%	-	6A			$\geq 3A$		ReFlow	
			1.6	NFE31PT152Z1E9	25Vdc	1500pF+50%-20%	-	6A		Kit	$\geq 3A$		ReFlow	
		2706 (6816)	p122	1.6	NFE61PT330B1H9	50Vdc	33pF+30%-30%	-	2A			$\geq 1A$		Flow ReFlow
				1.6	NFE61PT680B1H9	50Vdc	68pF+30%-30%	-	2A			$\geq 1A$		Flow ReFlow
				1.6	NFE61PT101Z1H9	50Vdc	100pF+30%-30%	-	2A			$\geq 1A$		Flow ReFlow
				1.6	NFE61PT181B1H9	50Vdc	180pF+30%-30%	-	2A			$\geq 1A$		Flow ReFlow
	2706 (6816)	p122	1.6	NFE61PT361B1H9	50Vdc	360pF+20%-20%	-	2A			$\geq 1A$		Flow ReFlow	
			1.6	NFE61PT681B1H9	50Vdc	680pF+30%-30%	-	2A			$\geq 1A$		Flow ReFlow	
			1.6	NFE61PT102E1H9	50Vdc	1000pF+80%-20%	-	2A		Kit	$\geq 1A$		Flow ReFlow	
			1.6	NFE61PT472C1H9	50Vdc	4700pF+80%-20%	-	2A		Kit	$\geq 1A$		Flow ReFlow	

Continued on the following page. ↗

△Note • Please read rating and △CAUTION (for storage, operating, rating, soldering, mounting and handling) in this catalog to prevent smoking and/or burning, etc.  
• This catalog has only typical specifications. Therefore, please approve our product specifications or transact the approval sheet for product specifications before ordering.



Type	Size Code in nch (in mm)	Thickness (mm)	Part Number	Rated Voltage	Capacitance	Nominal Cut-off Frequency	Rated Current	Performance							
								New	Kit	$\geq 1A$ $\geq 3A$ $\geq 10A$	D <sub>TV</sub>	F <sub>low</sub>	R <sub>eflow</sub>		
LC Combined Multilayer Type for Signal Lines	0402 (1005)	p140 0.3	NFL15ST157X0J3	6.3Vdc	22pF (Typ.)	150MHz	50mA	Kit		D <sub>TV</sub>	R <sub>eflow</sub>				
			NFL15ST207X0J3	6.3Vdc	17pF (Typ.)	200MHz	50mA	Kit		D <sub>TV</sub>	R <sub>eflow</sub>				
			NFL15ST307X0J3	6.3Vdc	12pF (Typ.)	300MHz	50mA	Kit			R <sub>eflow</sub>				
			NFL15ST507X0J3	6.3Vdc	7pF (Typ.)	500MHz	50mA	Kit			R <sub>eflow</sub>				
	0603 (1608)	p141 0.6	NFL18ST506H1A3	10Vdc	110pF (Typ.)	50MHz	75mA	Kit		D <sub>TV</sub>	R <sub>eflow</sub>				
			NFL18ST706H1A3	10Vdc	70pF (Typ.)	70MHz	75mA	Kit		D <sub>TV</sub>	R <sub>eflow</sub>				
			NFL18ST107H1A3	10Vdc	50pF (Typ.)	100MHz	75mA	Kit		D <sub>TV</sub>	R <sub>eflow</sub>				
			NFL18ST207H1A3	10Vdc	22pF (Typ.)	200MHz	100mA	Kit		D <sub>TV</sub>	R <sub>eflow</sub>				
			NFL18ST307H1A3	10Vdc	16pF (Typ.)	300MHz	100mA	Kit			R <sub>eflow</sub>				
			NFL18ST507H1A3	10Vdc	10pF (Typ.)	500MHz	100mA	Kit			R <sub>eflow</sub>				
		p142 0.8	NFL18ST207X1C3	16Vdc	25pF+20%-20%	200MHz	150mA	Kit			R <sub>eflow</sub>				
			NFL18ST307X1C3	16Vdc	18pF+20%-20%	300MHz	200mA	Kit			R <sub>eflow</sub>				
			NFL18ST507X1C3	16Vdc	10pF+20%-20%	500MHz	200mA	Kit			R <sub>eflow</sub>				
			p143 0.6	NFL18SP157X1A3	10Vdc	34pF+20%-20%	150MHz	100mA	Kit			R <sub>eflow</sub>			
	NFL18SP207X1A3	10Vdc		24pF+20%-20%	200MHz	100mA	Kit			R <sub>eflow</sub>					
	NFL18SP307X1A3	10Vdc		19pF+20%-20%	300MHz	100mA	Kit			R <sub>eflow</sub>					
	NFL18SP507X1A3	10Vdc		11pF+20%-20%	500MHz	100mA	Kit			R <sub>eflow</sub>					
	0805 (2012)	p144 0.85		NFL21SP106X1C3	16Vdc	670pF+20%-20%	10MHz	100mA	Kit			R <sub>eflow</sub>			
				NFL21SP206X1C7	16Vdc	240pF+20%-20%	20MHz	100mA	Kit			R <sub>eflow</sub>			
			NFL21SP506X1C3	16Vdc	84pF+20%-20%	50MHz	150mA	Kit			R <sub>eflow</sub>				
			NFL21SP706X1C3	16Vdc	76pF+20%-20%	70MHz	150mA	Kit			R <sub>eflow</sub>				
			NFL21SP107X1C3	16Vdc	44pF+20%-20%	100MHz	200mA	Kit			R <sub>eflow</sub>				
			NFL21SP157X1C3	16Vdc	28pF+20%-20%	150MHz	200mA	Kit			R <sub>eflow</sub>				
			NFL21SP207X1C3	16Vdc	22pF+20%-20%	200MHz	250mA	Kit			R <sub>eflow</sub>				
			NFL21SP307X1C3	16Vdc	19pF+10%-10%	300MHz	300mA	Kit			R <sub>eflow</sub>				
	p145 0.85	NFL21SP407X1C3	16Vdc	16pF+10%-10%	400MHz	300mA	Kit			R <sub>eflow</sub>					
		NFL21SP507X1C3	16Vdc	12pF+10%-10%	500MHz	300mA	Kit			R <sub>eflow</sub>					
	LC Combined Array Type for Signal Lines	0603 (1608)	p145 0.6	NFA18SL137V1A45	10Vdc	-	130MHz	50mA	Kit		D <sub>TV</sub>	R <sub>eflow</sub>			
				NFA18SL187V1A45	10Vdc	-	180MHz	50mA	Kit		D <sub>TV</sub>	R <sub>eflow</sub>			
				NFA18SL207V1A45	10Vdc	-	200MHz	50mA	Kit		D <sub>TV</sub>	R <sub>eflow</sub>			
				NFA18SL227V1A45	10Vdc	-	220MHz	25mA	Kit		D <sub>TV</sub>	R <sub>eflow</sub>			
			p146 0.5	NFA18SL307V1A45	10Vdc	-	300MHz	100mA	Kit			R <sub>eflow</sub>			
NFA18SL357V1A45				10Vdc	-	350MHz	35mA	Kit			R <sub>eflow</sub>				
NFA18SL407V1A45				10Vdc	-	400MHz	100mA	Kit			R <sub>eflow</sub>				
NFA18SL487V1A45				10Vdc	-	480MHz	100mA	Kit			R <sub>eflow</sub>				
p147 0.6				NFA18SD187X1A45	10Vdc	-	180MHz	25mA	Kit		D <sub>TV</sub>	R <sub>eflow</sub>			
				NFA18SD207X1A45	10Vdc	-	200MHz	25mA	Kit		D <sub>TV</sub>	R <sub>eflow</sub>			
0805 (2012)		p148 0.5	NFA21SL287V1A45	10Vdc	-	280MHz	100mA	Kit			R <sub>eflow</sub>				
			NFA21SL317V1A45	10Vdc	-	310MHz	100mA	Kit			R <sub>eflow</sub>				
			NFA21SL337V1A45	10Vdc	-	330MHz	100mA	Kit			R <sub>eflow</sub>				
			NFA21SL287V1A48	10Vdc	-	280MHz	100mA	Kit			R <sub>eflow</sub>				
			NFA21SL317V1A48	10Vdc	-	310MHz	100mA	Kit			R <sub>eflow</sub>				
			NFA21SL337V1A48	10Vdc	-	330MHz	100mA	Kit			R <sub>eflow</sub>				
			p149 0.5	NFA21SL207X1A45	10Vdc	-	200MHz	100mA	Kit			R <sub>eflow</sub>			
				NFA21SL307X1A45	10Vdc	-	300MHz	100mA	Kit			R <sub>eflow</sub>			
				NFA21SL506X1A48	10Vdc	-	50MHz	20mA	Kit			R <sub>eflow</sub>			
				NFA21SL806X1A48	10Vdc	-	80MHz	20mA	Kit			R <sub>eflow</sub>			
				NFA21SL207X1A48	10Vdc	-	200MHz	100mA	Kit			R <sub>eflow</sub>			
				NFA21SL307X1A48	10Vdc	-	300MHz	100mA	Kit			R <sub>eflow</sub>			
				LC Combined Wire Wound Type for Signal Lines	1206 (3216)	p150 1.8	NFW31SP106X1E4	25Vdc	-	10MHz	200mA	Kit		F <sub>low</sub>	R <sub>eflow</sub>
							NFW31SP206X1E4	25Vdc	-	20MHz	200mA	Kit		F <sub>low</sub>	R <sub>eflow</sub>
NFW31SP506X1E4	25Vdc	-	50MHz	200mA			Kit		F <sub>low</sub>	R <sub>eflow</sub>					
NFW31SP107X1E4	25Vdc	-	100MHz	200mA			Kit		F <sub>low</sub>	R <sub>eflow</sub>					
NFW31SP157X1E4	25Vdc	-	150MHz	200mA			Kit		F <sub>low</sub>	R <sub>eflow</sub>					
NFW31SP207X1E4	25Vdc	-	200MHz	200mA			Kit		F <sub>low</sub>	R <sub>eflow</sub>					
NFW31SP307X1E4	25Vdc	-	300MHz	200mA			Kit		F <sub>low</sub>	R <sub>eflow</sub>					
NFW31SP407X1E4	25Vdc	-	400MHz	200mA			Kit		F <sub>low</sub>	R <sub>eflow</sub>					
NFW31SP507X1E4	25Vdc	-	500MHz	200mA	Kit		F <sub>low</sub>	R <sub>eflow</sub>							

Continued on the following page.

⚠Note • Please read rating and ⚠CAUTION (for storage, operating, rating, soldering, mounting and handling) in this catalog to prevent smoking and/or burning, etc.  
• This catalog has only typical specifications. Therefore, please approve our product specifications or transact the approval sheet for product specifications before ordering.

Type	Size Code in nch (in mm)	Thickness (mm)	Part Number	Rated Voltage	Capacitance	Nominal Cut-off Frequency	Rated Current	New	Kit	$\geq 1A$	$\geq 3A$	$\geq 10A$	DTV	Flow	Reflow	
RC Combined Type for Signal Lines	0805 (2012)	p152	0.5	<b>NFR21GD1002202</b>	50Vdc	10pF+20%-20%	-	50mA								Reflow
		0.5	<b>NFR21GD1004702</b>	50Vdc	10pF+20%-20%	-	35mA									Reflow
		0.5	<b>NFR21GD4702202</b>	50Vdc	47pF+20%-20%	-	50mA									Reflow
		0.5	<b>NFR21GD4704702</b>	50Vdc	47pF+20%-20%	-	35mA									Reflow
		0.5	<b>NFR21GD4706802</b>	50Vdc	47pF+20%-20%	-	30mA									Reflow
		0.5	<b>NFR21GD4701012</b>	50Vdc	47pF+20%-20%	-	25mA									Reflow
		0.5	<b>NFR21GD1012202</b>	50Vdc	100pF+20%-20%	-	50mA									Reflow
		0.5	<b>NFR21GD1014702</b>	50Vdc	100pF+20%-20%	-	35mA									Reflow
		0.5	<b>NFR21GD1016802</b>	50Vdc	100pF+20%-20%	-	30mA									Reflow
RC Combined Array Type for Signal Lines	1206 (3216)	p153	0.8	<b>NFA31GD1006R84</b>	6Vdc	10pF+20%-20%	-	50mA								Reflow
		0.8	<b>NFA31GD1004704</b>	6Vdc	10pF+20%-20%	-	20mA									Reflow
		0.8	<b>NFA31GD1001014</b>	6Vdc	10pF+20%-20%	-	15mA									Reflow
		0.8	<b>NFA31GD4706R84</b>	6Vdc	47pF+20%-20%	-	50mA									Reflow
		0.8	<b>NFA31GD4703304</b>	6Vdc	47pF+20%-20%	-	20mA									Reflow
		0.8	<b>NFA31GD4704704</b>	6Vdc	47pF+20%-20%	-	20mA									Reflow
		0.8	<b>NFA31GD4701014</b>	6Vdc	47pF+20%-20%	-	15mA									Reflow
		0.8	<b>NFA31GD1016R84</b>	6Vdc	100pF+20%-20%	-	50mA									Reflow
		0.8	<b>NFA31GD1014704</b>	6Vdc	100pF+20%-20%	-	20mA									Reflow
0.8	<b>NFA31GD1011014</b>	6Vdc	100pF+20%-20%	-	15mA									Reflow		

△Note • Please read rating and △CAUTION (for storage, operating, rating, soldering, mounting and handling) in this catalog to prevent smoking and/or burning, etc.  
• This catalog has only typical specifications. Therefore, please approve our product specifications or transact the approval sheet for product specifications before ordering.

Chip Ferrite Bead

Chip EMIFIL®

Chip Common Mode Choke Coil

Block Type EMIFIL®

Microwave Absorber

# NFE31PT Series 1206/3216 (inch/mm)



Meets 6A, T-type filter with built-in ferrite bead.

### ■ Dimensions

(1) (2) (3)

1.6±0.15

3.2±0.35

1.6±0.15

□: Electrode  
(in mm)

### ■ Equivalent Circuit

GND  
(2)  
No polarity.

### ■ Packaging

Code	Packaging	Minimum Quantity
L	180mm Reel Embossed Tape	2000
K	330mm Reel Embossed Tape	8000
B	Bulk(Bag)	500

Refer to pages from p.156 to p.162 for mounting information.

### ■ Rated Value (□: packaging code)

Part Number	Capacitance	Rated Current	Rated Voltage	Insulation Resistance (min.)	Operating Temperature Range	
NFE31PT220R1E9□	22pF ±30%	6A	25Vdc	1000M ohm	-40°C to +85°C	≥3A
NFE31PT470C1E9□	47pF 50/-20%	6A	25Vdc	1000M ohm	-40°C to +85°C	≥3A
NFE31PT101C1E9□	100pF 80/-20%	6A	25Vdc	1000M ohm	-40°C to +85°C	≥3A
NFE31PT221D1E9□	220pF 50/-20%	6A	25Vdc	1000M ohm	-40°C to +85°C	≥3A
NFE31PT471F1E9□	470pF 50/-20%	6A	25Vdc	1000M ohm	-40°C to +85°C	≥3A
NFE31PT152Z1E9□	1500pF 50/-20%	6A	25Vdc	1000M ohm	-40°C to +85°C	Kit ≥3A
NFE31PT222Z1E9□	2200pF ±50%	6A	25Vdc	1000M ohm	-40°C to +85°C	Kit ≥3A

Number of Circuit: 1

### ■ Insertion Loss Characteristics

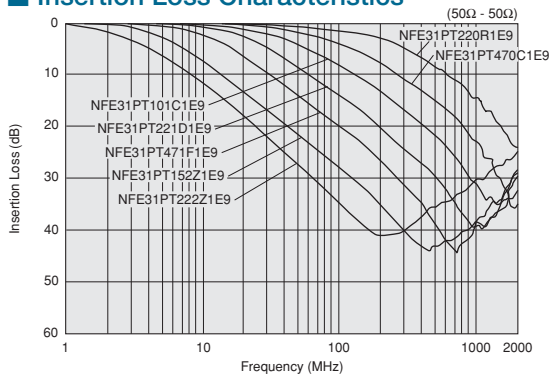

△Note • Please read rating and △CAUTION (for storage, operating, rating, soldering, mounting and handling) in this catalog to prevent smoking and/or burning, etc.  
• This catalog has only typical specifications. Therefore, please approve our product specifications or transact the approval sheet for product specifications before ordering.

Chip Ferrite Bead  
Universal Type [Power Lines/Signal Lines] Chip EMIFIL®  
Chip Common Mode Choke Coil  
Block Type EMIFIL®  
Microwave Absorber

# NFE61PT Series 2706/6816 (inch/mm)



## T-type filter with built-in ferrite bead.



### Dimensions

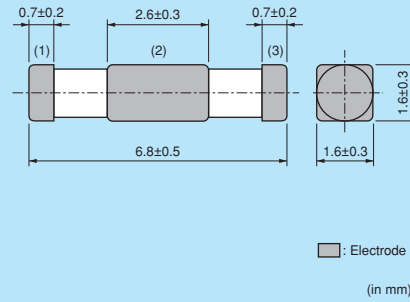

### Equivalent Circuit

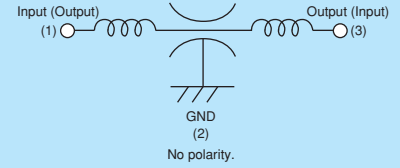

### Packaging

Code	Packaging	Minimum Quantity
L	180mm Reel Embossed Tape	2500
K	330mm Reel Embossed Tape	8000
B	Bulk(Bag)	500

Refer to pages from p.156 to p.162 for mounting information.

### Rated Value (□: packaging code)

Part Number	Capacitance	Rated Current	Rated Voltage	Insulation Resistance (min.)	Operating Temperature Range	
NFE61PT330B1H9□	33pF ±30%	2A	50Vdc	1000M ohm	-40°C to +85°C	≥1A
NFE61PT680B1H9□	68pF ±30%	2A	50Vdc	1000M ohm	-40°C to +85°C	≥1A
NFE61PT101Z1H9□	100pF ±30%	2A	50Vdc	1000M ohm	-40°C to +85°C	≥1A
NFE61PT181B1H9□	180pF ±30%	2A	50Vdc	1000M ohm	-40°C to +85°C	≥1A
NFE61PT361B1H9□	360pF ±20%	2A	50Vdc	1000M ohm	-40°C to +85°C	≥1A
NFE61PT681B1H9□	680pF ±30%	2A	50Vdc	1000M ohm	-40°C to +85°C	≥1A
NFE61PT102E1H9□	1000pF 80/-20%	2A	50Vdc	1000M ohm	-40°C to +85°C	Kit ≥1A
NFE61PT472C1H9□	4700pF 80/-20%	2A	50Vdc	1000M ohm	-40°C to +85°C	Kit ≥1A

Number of Circuit: 1

### Insertion Loss Characteristics

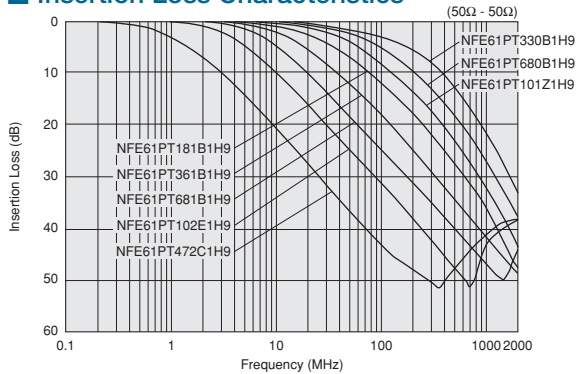

△Note • Please read rating and △CAUTION (for storage, operating, rating, soldering, mounting and handling) in this catalog to prevent smoking and/or burning, etc.  
 • This catalog has only typical specifications. Therefore, please approve our product specifications or transact the approval sheet for product specifications before ordering.

Chip Ferrite Bead  
Chip EMIFIL® Universal Type [Power Lines/Signal Lines]  
Chip Common Mode Choke Coil  
Block Type EMIFIL®  
Microwave Absorber

# NFM15PC Series 0402/1005 (inch/mm)



0402 size chip 3-terminal capacitor for power lines.

**NFM15PC (0.047, 0.1, 0.22, 4.3μF)**

**■ Dimensions**

(in mm)

**■ Equivalent Circuit**

No polarity.

**■ Packaging**

Code	Packaging	Minimum Quantity
D	180mm Reel Paper Tape	10000
B	Bulk(Bag)	500

**NFM15PCC (0.47 to 1μF)**

**■ Dimensions**

(in mm)

**■ Equivalent Circuit**

No polarity.

**■ Packaging**

Code	Packaging	Minimum Quantity
D	180mm Reel Paper Tape	10000
B	Bulk(Bag)	500

Refer to pages from p.156 to p.162 for mounting information.

**■ Rated Value** (□: packaging code)

Part Number	Capacitance	Rated Current	Rated Voltage	Insulation Resistance (min.)	Operating Temperature Range	
NFM15PC473C1A3□	0.047μF ±20%	1A	10Vdc	1000M ohm	-55°C to +105°C	New Kit ≥1A
NFM15PC473C1C3□	0.047μF ±20%	1A	16Vdc	1000M ohm	-55°C to +85°C	New Kit ≥1A
NFM15PC104D0J3□	0.1μF ±20%	2A	6.3Vdc	1000M ohm	-55°C to +105°C	New Kit ≥1A
NFM15PC104R1A3□	0.1μF ±20%	2A	10Vdc	1000M ohm	-55°C to +85°C	New Kit ≥1A
NFM15PC224D0J3□	0.22μF ±20%	2A	6.3Vdc	1000M ohm	-55°C to +105°C	New Kit ≥1A
NFM15PC224R1A3□	0.22μF ±20%	2A	10Vdc	1000M ohm	-55°C to +85°C	New Kit ≥1A
NFM15PC474D0G3□	0.47μF ±20%	2A	4Vdc	1000M ohm	-55°C to +105°C	New Kit ≥1A
NFM15PC474R0J3□	0.47μF ±20%	2A	6.3Vdc	1000M ohm	-55°C to +85°C	New Kit ≥1A
NFM15PC105R0G3□	1μF ±20%	2A	4Vdc	500M ohm	-55°C to +85°C	New Kit ≥1A
NFM15PC435R0E3□	4.3μF ±20%	2A	2.5Vdc	25M ohm	-55°C to +85°C	New Kit ≥1A

Number of Circuit: 1

Continued on the following page.

△Note • Please read rating and △CAUTION (for storage, operating, rating, soldering, mounting and handling) in this catalog to prevent smoking and/or burning, etc.  
 • This catalog has only typical specifications. Therefore, please approve our product specifications or transact the approval sheet for product specifications before ordering.

■ Insertion Loss Characteristics

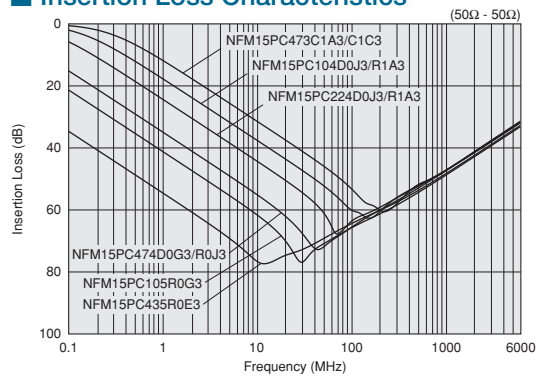

Chip Ferrite Bead

Chip EMIFIL®  
 Power Lines Type

Chip Common Mode Choke Coil

Block Type EMIFIL®

Microwave Absorber

⚠Note • Please read rating and ⚠CAUTION (for storage, operating, rating, soldering, mounting and handling) in this catalog to prevent smoking and/or burning, etc.  
 • This catalog has only typical specifications. Therefore, please approve our product specifications or transact the approval sheet for product specifications before ordering.

# NFM18PS Series 0603/1608 (inch/mm)



## 3-terminal capacitor for power lines whose ground impedance has reduced.

\*Please refer to the products designed for both power lines and signal lines.



### ■ Dimensions

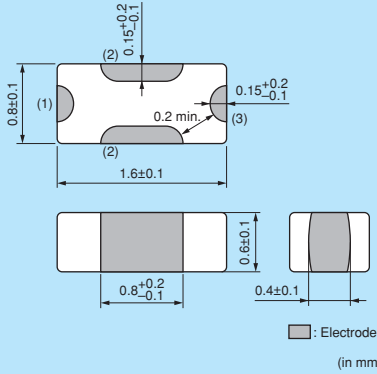

(in mm)

### ■ Equivalent Circuit

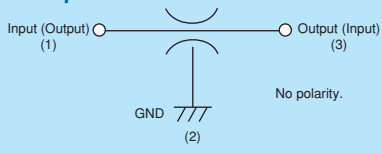

No polarity.

### ■ Packaging

Code	Packaging	Minimum Quantity
D	180mm Reel Paper Tape	4000
B	Bulk(Bag)	500

Refer to pages from p.156 to p.162 for mounting information.

### ■ Rated Value (□: packaging code)

Part Number	Capacitance	Rated Current	Rated Voltage	Insulation Resistance (min.)	Operating Temperature Range	
NFM18PS474R0J3□	0.47μF ±20%	2A	6.3Vdc	1000M ohm	-55°C to +125°C	Kit ≥1A
NFM18PS105D0J3□	1.0μF ±20%	2A	6.3Vdc	500M ohm	-55°C to +125°C	New Kit ≥1A
NFM18PS105R0J3□	1.0μF ±20%	2A	6.3Vdc	500M ohm	-55°C to +105°C	Kit ≥1A

Number of Circuit: 1

### ■ Insertion Loss Characteristics

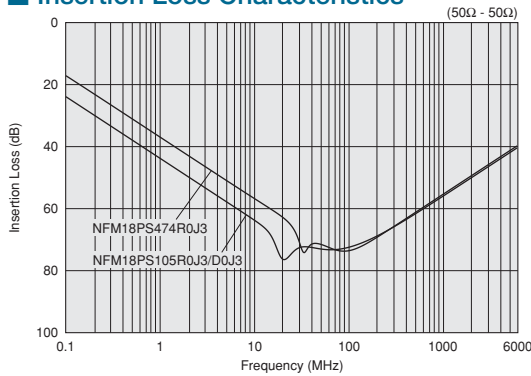

⚠Note • Please read rating and ⚠CAUTION (for storage, operating, rating, soldering, mounting and handling) in this catalog to prevent smoking and/or burning, etc.  
 • This catalog has only typical specifications. Therefore, please approve our product specifications or transact the approval sheet for product specifications before ordering.

# NFM18PC Series 0603/1608 (inch/mm)



## 4A max., 0603 size chip 3-terminal capacitor for power lines.

\*Please refer to the products designed for both power lines and signal lines.

Chip Ferrite Bead

Chip EMIFIL® Power Lines Type

Chip Common Mode Choke Coil

Block Type EMIFIL®

Microwave Absorber

### NFM18PC (0.1 to 0.47μF, 2.2μF - 6.3V)



#### ■ Dimensions

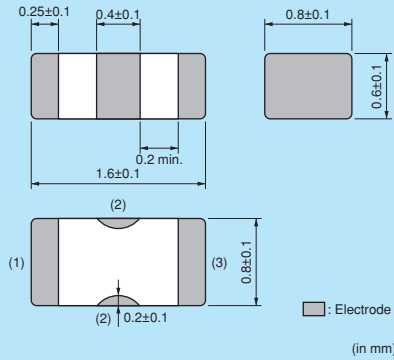

#### ■ Equivalent Circuit

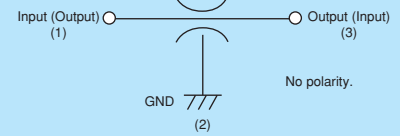

#### ■ Packaging

Code	Packaging	Minimum Quantity
D	180mm Reel Paper Tape	4000
B	Bulk(Bag)	500

### NFM18PC (1μF, 2.2μF - 10V)



#### ■ Dimensions

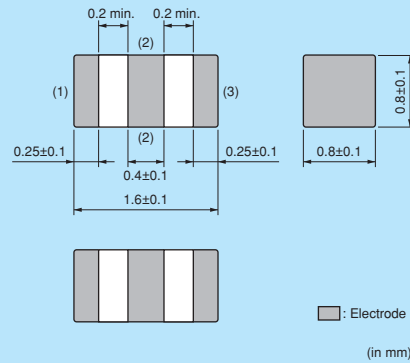

#### ■ Equivalent Circuit

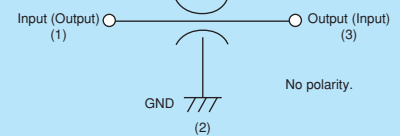

#### ■ Packaging

Code	Packaging	Minimum Quantity
D	180mm Reel Paper Tape	4000
B	Bulk(Bag)	500

Refer to pages from p.156 to p.162 for mounting information.

### ■ Rated Value (□: packaging code)

Part Number	Capacitance	Rated Current	Rated Voltage	Insulation Resistance (min.)	Operating Temperature Range	
NFM18PC104R1C3□	0.1μF ±20%	2A	16Vdc	1000M ohm	-55°C to +125°C	Kit ≥1A
NFM18PC224R0J3□	0.22μF ±20%	2A	6.3Vdc	1000M ohm	-55°C to +125°C	Kit ≥1A
NFM18PC474R0J3□	0.47μF ±20%	2A	6.3Vdc	1000M ohm	-55°C to +125°C	Kit ≥1A
NFM18PC105R0J3□	1.0μF ±20%	4A	6.3Vdc	500M ohm	-55°C to +105°C	Kit ≥1A
NFM18PC225B0J3□	2.2μF ±20%	2A	6.3Vdc	200M ohm	-40°C to +85°C	Kit ≥1A
NFM18PC225B1A3□	2.2μF ±20%	4A	10Vdc	200M ohm	-40°C to +85°C	Kit ≥3A

Number of Circuit: 1

### ■ Insertion Loss Characteristics

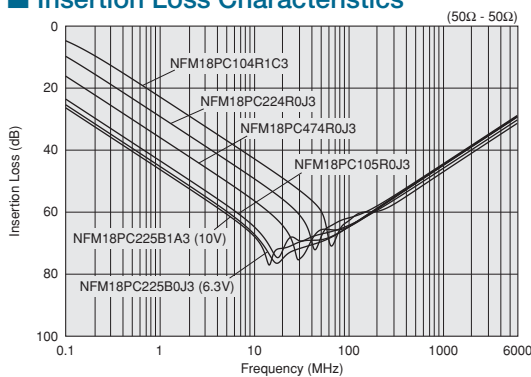

△Note • Please read rating and △CAUTION (for storage, operating, rating, soldering, mounting and handling) in this catalog to prevent smoking and/or burning, etc.  
 • This catalog has only typical specifications. Therefore, please approve our product specifications or transact the approval sheet for product specifications before ordering.



• High frequency performance of NFM18PS series

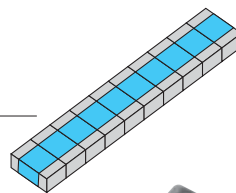
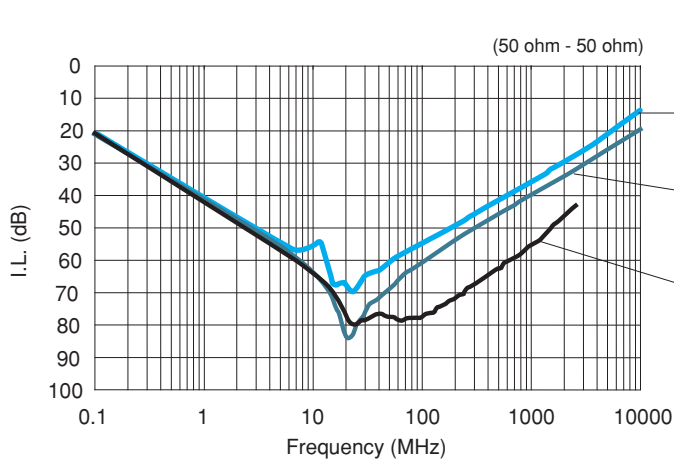

Chip 3-terminal capacitor

2 terminal MLCC: 2012mm size  
(0.1μF×10pcs parallel)

NFM18PC105R0J3 1pc  
: 1608mm size (1.0μF×1)

NFM18PS105R0J3 1pc  
: 1608mm size (1.0μF×1)

NFM18PS series has better high-frequency performance compared to normal chip 3 terminal capacitors.

• Optimize of bypass capacitors using chip 3-terminal capacitor

Number of parts can be reduced.  
⇒ • Reduce PCB space  
• Reduce mount cost

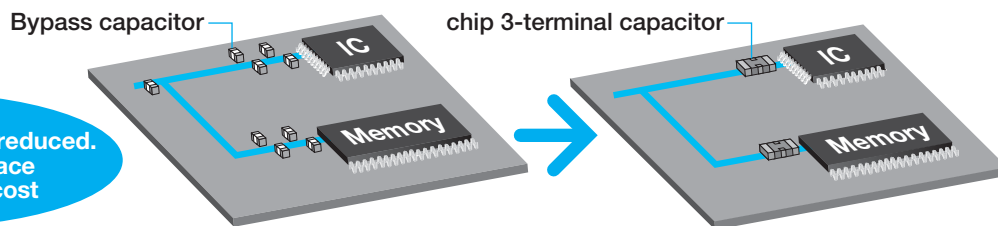

Comparison of performance as a bypass capacitor

Without capacitor

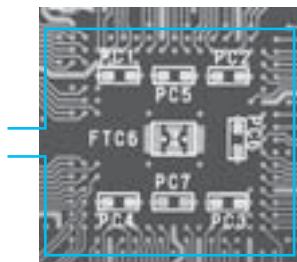

Micro computer

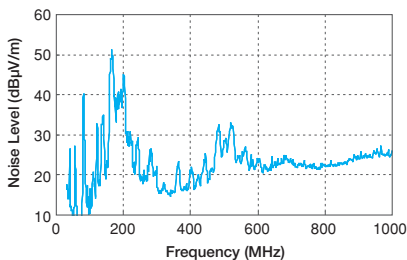

With MLCC 0.22μF×4

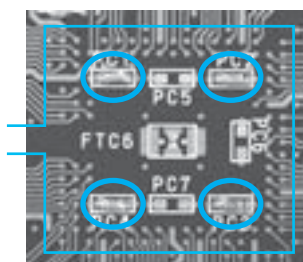

Micro computer

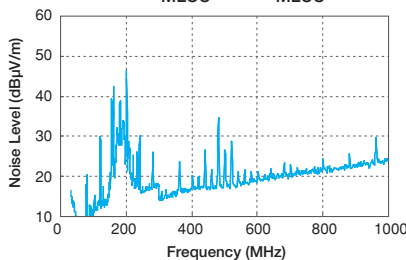
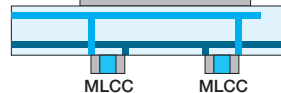

With chip 3-terminal capacitor (NFM) 1μF×1

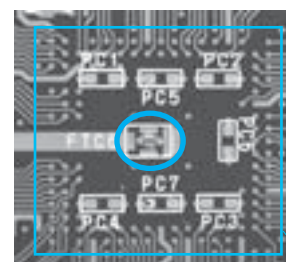

Micro computer

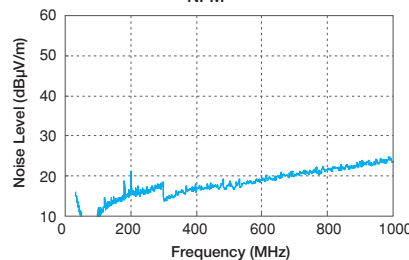
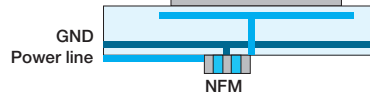

Noise suppression effect of NFM series is better than MLCCs (1 NFM is better than 4 MLCCs).

△Note • Please read rating and △CAUTION (for storage, operating, rating, soldering, mounting and handling) in this catalog to prevent smoking and/or burning, etc.  
• This catalog has only typical specifications. Therefore, please approve our product specifications or transact the approval sheet for product specifications before ordering.

# NFM21PS Series 0805/2012 (inch/mm)



0805 size 3-terminal capacitor with very low ground impedance.



### ■ Dimensions

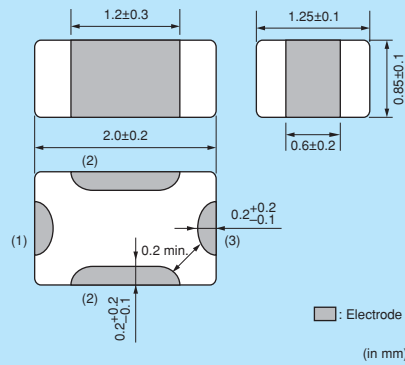

### ■ Equivalent Circuit

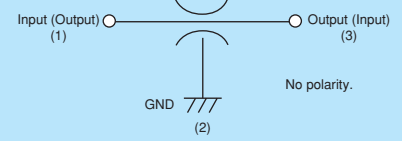

### ■ Packaging

Code	Packaging	Minimum Quantity
D	180mm Reel Paper Tape	4000
B	Bulk(Bag)	500

Refer to pages from p.156 to p.162 for mounting information.

### ■ Rated Value (□: packaging code)

Part Number	Capacitance	Rated Current	Rated Voltage	Insulation Resistance (min.)	Operating Temperature Range	
NFM21PS106B0J3□	10μF ±20%	4A	6.3Vdc	50M ohm	-40°C to +85°C	Kit ≥3A

Number of Circuit: 1

### ■ Insertion Loss Characteristics

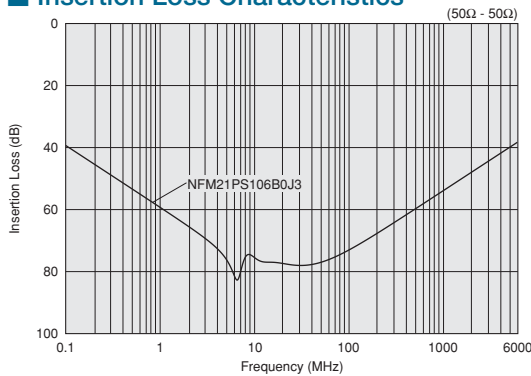

⚠Note • Please read rating and ⚠CAUTION (for storage, operating, rating, soldering, mounting and handling) in this catalog to prevent smoking and/or burning, etc.  
 • This catalog has only typical specifications. Therefore, please approve our product specifications or transact the approval sheet for product specifications before ordering.

Chip Ferrite Bead  
Chip EMIFIL® Power Lines Type  
Chip Common Mode Choke Coil  
Block Type EMIFIL®  
Microwave Absorber

# NFM21PC Series 0805/2012 (inch/mm)



## 6A max., 0805 size chip 3-terminal capacitor for power lines.

\*Please refer to the products designed for both power lines and signal lines.



### ■ Dimensions

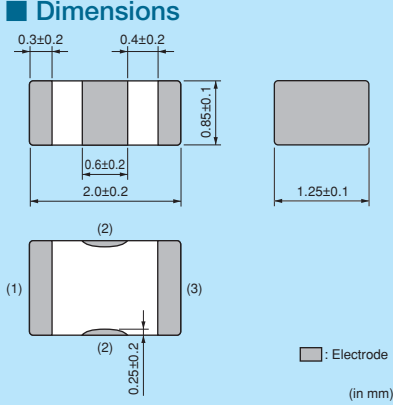

(in mm)

### ■ Equivalent Circuit

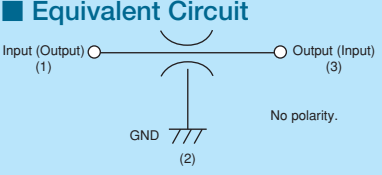

No polarity.

### ■ Packaging

Code	Packaging	Minimum Quantity
D	180mm Reel Paper Tape	4000
B	Bulk(Bag)	500

Refer to pages from p.156 to p.162 for mounting information.

### ■ Rated Value (□: packaging code)

Part Number	Capacitance	Rated Current	Rated Voltage	Insulation Resistance (min.)	Operating Temperature Range	
NFM21PC104R1E3□	0.1μF ±20%	2A	25Vdc	1000M ohm	-55°C to +125°C	Kit ≥1A
NFM21PC224R1C3□	0.22μF ±20%	2A	16Vdc	1000M ohm	-55°C to +125°C	Kit ≥1A
NFM21PC474R1C3□	0.47μF ±20%	2A	16Vdc	1000M ohm	-55°C to +125°C	Kit ≥1A
NFM21PC105B1A3□	1.0μF ±20%	4A	10Vdc	500M ohm	-40°C to +85°C	Kit ≥3A
NFM21PC105B1C3□	1.0μF ±20%	4A	16Vdc	500M ohm	-40°C to +85°C	Kit ≥3A
NFM21PC225B0J3□	2.2μF ±20%	4A	6.3Vdc	200M ohm	-40°C to +85°C	Kit ≥3A
NFM21PC475B1A3□	4.7μF ±20%	6A	10Vdc	100M ohm	-40°C to +85°C	Kit ≥3A

Number of Circuit: 1

### ■ Insertion Loss Characteristics

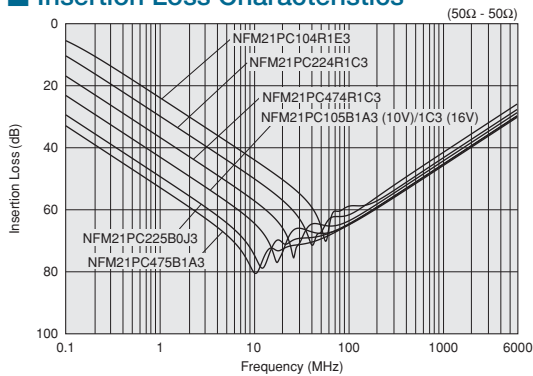

⚠Note • Please read rating and ⚠CAUTION (for storage, operating, rating, soldering, mounting and handling) in this catalog to prevent smoking and/or burning, etc.  
 • This catalog has only typical specifications. Therefore, please approve our product specifications or transact the approval sheet for product specifications before ordering.

# NFM3DPC Series 1205/3212 (inch/mm)



## 1205 size 3-terminal capacitor for power lines.

\*Please refer to the products designed for both power lines and signal lines.



### ■ Dimensions

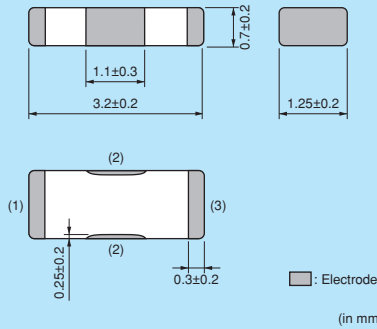

### ■ Equivalent Circuit

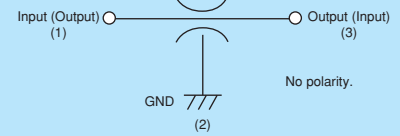

### ■ Packaging

Code	Packaging	Minimum Quantity
L	180mm Reel Embossed Tape	4000
B	Bulk(Bag)	500

Refer to pages from p.156 to p.162 for mounting information.

### ■ Rated Value (□: packaging code)

Part Number	Capacitance	Rated Current	Rated Voltage	Insulation Resistance (min.)	Operating Temperature Range	
NFM3DPC223R1H3□	0.022μF ±20%	2A	50Vdc	1000M ohm	-55°C to +125°C	≥1A

Number of Circuit: 1

### ■ Insertion Loss Characteristics

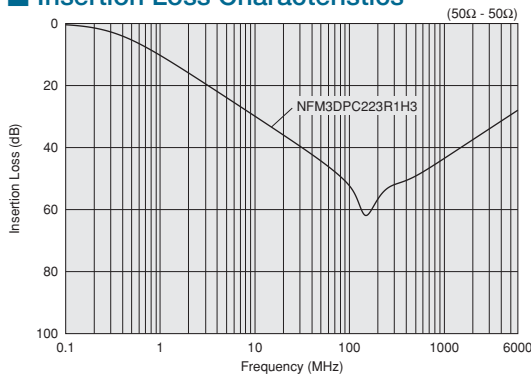

### ■ Notice (Rating)

When NFM3DPC series is used in operating temperature exceeding +85°C, derating of current is necessary. Please apply the derating curve shown in chart according to the operating temperature.

#### Derating of Rated Current

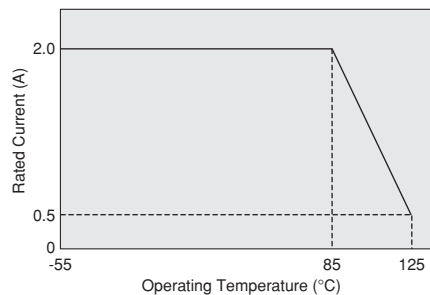

⚠Note • Please read rating and ⚠CAUTION (for storage, operating, rating, soldering, mounting and handling) in this catalog to prevent smoking and/or burning, etc.  
 • This catalog has only typical specifications. Therefore, please approve our product specifications or transact the approval sheet for product specifications before ordering.

Chip Ferrite Bead

Chip EMIFIL®  
Power Lines Type

Chip Common Mode Choke Coil

Block Type EMIFIL®

Microwave Absorber

# NFM31PC Series 1206/3216 (inch/mm)



6A/27microF, 1206 size chip 3-terminal capacitor for power lines.

\*Please refer to the products designed for both power lines and signal lines.

### ■ Dimensions

0.4±0.3, 1.1±0.3, 0.4±0.3, 3.2±0.2, 1.6±0.2, 1.3±0.2, 1.6±0.2, 0.3±0.2

Legend:  Electrode (in mm)

### ■ Equivalent Circuit

Input (Output) (1) — Capacitor — Output (Input) (3)  
GND (2)

No polarity.

### ■ Packaging

Code	Packaging	Minimum Quantity
L	180mm Reel Embossed Tape	3000
B	Bulk(Bag)	500

Refer to pages from p.156 to p.162 for mounting information.

### ■ Rated Value (□: packaging code)

Part Number	Capacitance	Rated Current	Rated Voltage	Insulation Resistance (min.)	Operating Temperature Range	
NFM31PC276B0J3□	27μF ±20%	6A	6.3Vdc	20M ohm	-40°C to +85°C	Kit ≥3A

Number of Circuit: 1

### ■ Insertion Loss Characteristics

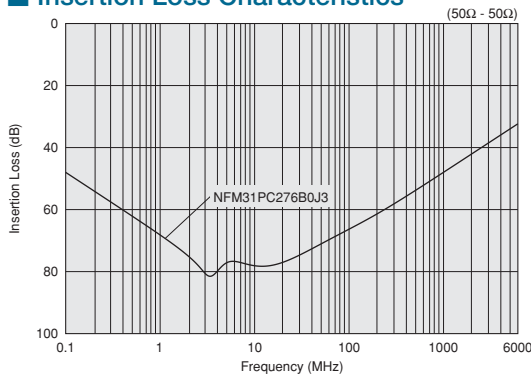

⚠Note • Please read rating and ⚠CAUTION (for storage, operating, rating, soldering, mounting and handling) in this catalog to prevent smoking and/or burning, etc.  
• This catalog has only typical specifications. Therefore, please approve our product specifications or transact the approval sheet for product specifications before ordering.

# NFM31KC Series 1206/3216 (inch/mm)



Capable for 10A max. Large current 3-terminal capacitor.



### Dimensions

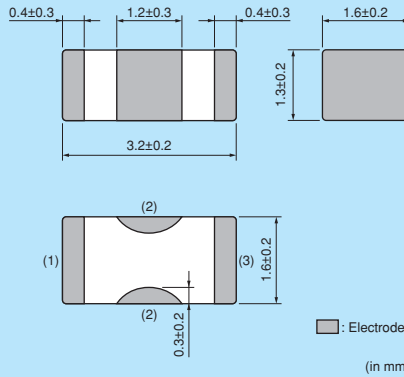

### Equivalent Circuit

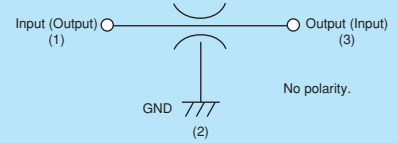

### Packaging

Code	Packaging	Minimum Quantity
L	180mm Reel Embossed Tape	3000
B	Bulk(Bag)	500

Refer to pages from p.156 to p.162 for mounting information.

### Rated Value (□: packaging code)

Part Number	Capacitance	Rated Current	Rated Voltage	Insulation Resistance (min.)	Operating Temperature Range	Kit	Current
NFM31KC103R1H3□	10000pF ±20%	10A	50Vdc	1000M ohm	-55°C to +125°C	Kit	≥10A
NFM31KC103R2A3□	10000pF ±20%	10A	100Vdc	1000M ohm	-55°C to +125°C	Kit	≥10A
NFM31KC153R1H3□	15000pF ±20%	10A	50Vdc	1000M ohm	-55°C to +125°C	Kit	≥10A
NFM31KC153R2A3□	15000pF ±20%	10A	100Vdc	1000M ohm	-55°C to +105°C	Kit	≥10A
NFM31KC223R1H3□	22000pF ±20%	10A	50Vdc	1000M ohm	-55°C to +125°C	Kit	≥10A
NFM31KC223R2A3□	22000pF ±20%	10A	100Vdc	1000M ohm	-55°C to +105°C	Kit	≥10A
NFM31KC104R1H3□	100000pF ±20%	6A	50Vdc	1000M ohm	-55°C to +125°C	Kit	≥3A
NFM31KC104R2A3□	100000pF ±20%	6A	100Vdc	1000M ohm	-55°C to +105°C	Kit	≥3A

Number of Circuit: 1

### Insertion Loss Characteristics

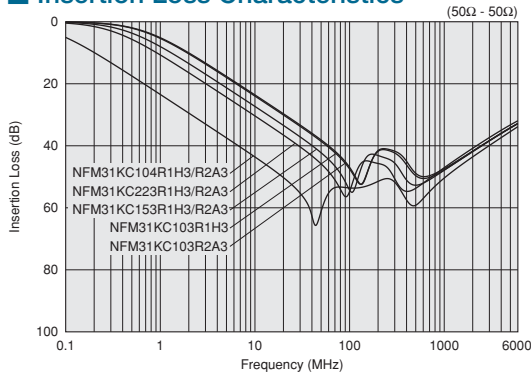

### Notice (Rating)

When NFM31KC series is used in operating temperatures exceeding +105°C, derating of current is necessary. Please apply the derating curve shown in chart according to the operating temperature.

Derating of Rated Current (Except for NFM31KC 153/223/104 R2A3, NFM31KC104R1H3)

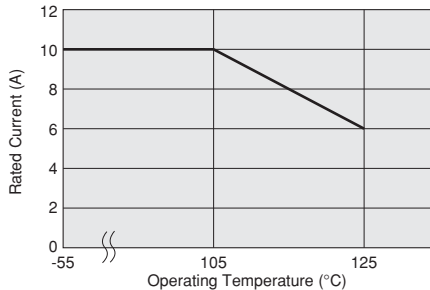

△Note • Please read rating and △CAUTION (for storage, operating, rating, soldering, mounting and handling) in this catalog to prevent smoking and/or burning, etc.  
 • This catalog has only typical specifications. Therefore, please approve our product specifications or transact the approval sheet for product specifications before ordering.

Chip Ferrite Bead  
 Chip EMIFIL® Power Lines Type  
 Chip Common Mode Choke Coil  
 Block Type EMIFIL®  
 Microwave Absorber

# NFM41PC Series 1806/4516 (inch/mm)



## 6A max., 1806 size chip 3-terminal capacitor for power lines.

\*Please refer to the products designed for both power lines and signal lines.



### ■ Dimensions

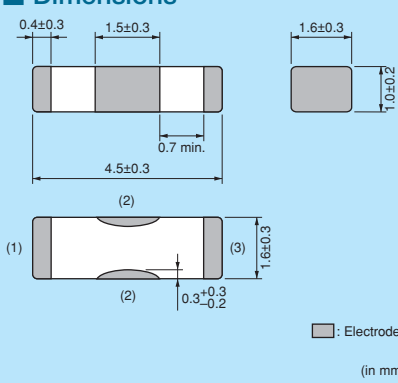

(in mm)

### ■ Equivalent Circuit

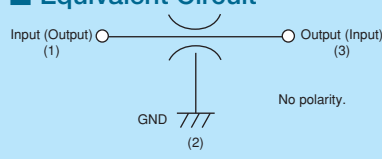

No polarity.

### ■ Packaging

Code	Packaging	Minimum Quantity
L	180mm Reel Embossed Tape	4000
B	Bulk(Bag)	500

Refer to pages from p.156 to p.162 for mounting information.

### ■ Rated Value (□: packaging code)

Part Number	Capacitance	Rated Current	Rated Voltage	Insulation Resistance (min.)	Operating Temperature Range	
NFM41PC204F1H3□	0.2μF 80/-20%	2A	50Vdc	1000M ohm	-55°C to +85°C	Kit ≥1A
NFM41PC155B1E3□	1.5μF ±20%	6A	25Vdc	300M ohm	-55°C to +85°C	Kit ≥3A
NFM41PC155B1H3□	1.5μF ±20%	6A	50Vdc	100M ohm	-55°C to +85°C	New ≥3A

Number of Circuit: 1

### ■ Insertion Loss Characteristics

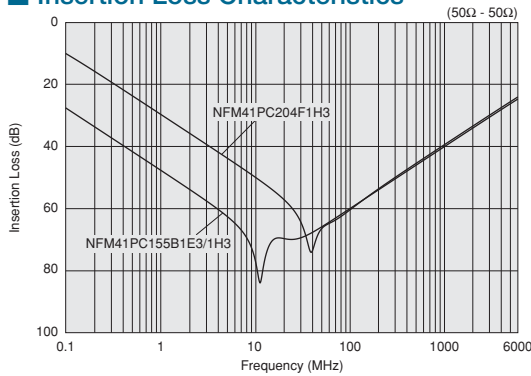

⚠Note • Please read rating and ⚠CAUTION (for storage, operating, rating, soldering, mounting and handling) in this catalog to prevent smoking and/or burning, etc.  
 • This catalog has only typical specifications. Therefore, please approve our product specifications or transact the approval sheet for product specifications before ordering.

# NFM15CC Series 0402/1005 (inch/mm)



0402 size chip 3-terminal capacitor for signal lines.

### ■ Dimensions

0.17±0.1, 0.35±0.1, 1.0±0.1, 0.5±0.2, 0.4±0.1, 0.5±0.2, 0.15±0.1

Legend:  Electrode (in mm)

### ■ Equivalent Circuit

Input (Output) (1) ———— Output (Input) (3)  
GND (2)

No polarity.

### ■ Packaging

Code	Packaging	Minimum Quantity
D	180mm Reel Paper Tape	10000
B	Bulk(Bag)	500

Refer to pages from p.156 to p.162 for mounting information.

### ■ Rated Value (□: packaging code)

Part Number	Capacitance	Rated Current	Rated Voltage	Insulation Resistance (min.)	Operating Temperature Range	
NFM15CC222D1A3□	2200pF ±20%	1A	10Vdc	1000M ohm	-55°C to +105°C	New Kit ≥1A
NFM15CC222D1C3□	2200pF ±20%	1A	16Vdc	1000M ohm	-55°C to +85°C	New Kit ≥1A
NFM15CC223C1A3□	22000pF ±20%	1A	10Vdc	1000M ohm	-55°C to +105°C	New Kit ≥1A
NFM15CC223C1C3□	22000pF ±20%	1A	16Vdc	1000M ohm	-55°C to +85°C	New Kit ≥1A

Number of Circuit: 1

### ■ Insertion Loss Characteristics

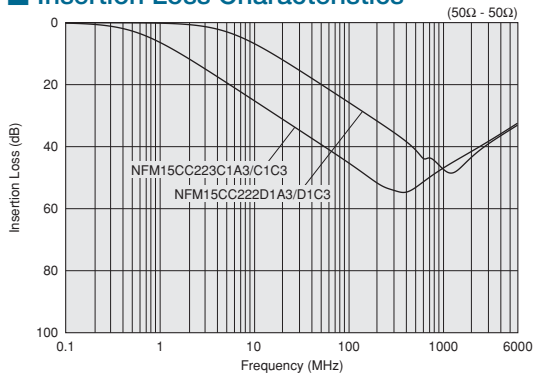

⚠Note • Please read rating and ⚠CAUTION (for storage, operating, rating, soldering, mounting and handling) in this catalog to prevent smoking and/or burning, etc.  
• This catalog has only typical specifications. Therefore, please approve our product specifications or transact the approval sheet for product specifications before ordering.

Chip Ferrite Bead

Chip EMIFIL®  
Signal Lines Type

Chip Common Mode Choke Coil

Block Type EMIFIL®

Microwave Absorber



# NFM18CC Series 0603/1608 (inch/mm)



## 0603 size general 3-terminal capacitor.

### ■ Dimensions

(in mm)

### ■ Equivalent Circuit

No polarity.

### ■ Packaging

Code	Packaging	Minimum Quantity
D	180mm Reel Paper Tape	4000
B	Bulk(Bag)	500

Refer to pages from p.156 to p.162 for mounting information.

### ■ Rated Value (□: packaging code)

Part Number	Capacitance	Rated Current	Rated Voltage	Insulation Resistance (min.)	Operating Temperature Range	
NFM18CC220U1C3□	22pF ±20%	400mA	16Vdc	1000M ohm	-55°C to +125°C	Kit
NFM18CC470U1C3□	47pF ±20%	400mA	16Vdc	1000M ohm	-55°C to +125°C	Kit
NFM18CC101R1C3□	100pF ±20%	500mA	16Vdc	1000M ohm	-55°C to +125°C	Kit
NFM18CC221R1C3□	220pF ±20%	500mA	16Vdc	1000M ohm	-55°C to +125°C	Kit
NFM18CC471R1C3□	470pF ±20%	500mA	16Vdc	1000M ohm	-55°C to +125°C	Kit
NFM18CC102R1C3□	1000pF ±20%	600mA	16Vdc	1000M ohm	-55°C to +125°C	Kit
NFM18CC222R1C3□	2200pF ±20%	700mA	16Vdc	1000M ohm	-55°C to +125°C	Kit
NFM18CC223R1C3□	22000pF ±20%	1000mA	16Vdc	1000M ohm	-55°C to +125°C	Kit ≥1A

Number of Circuit: 1

### ■ Insertion Loss Characteristics

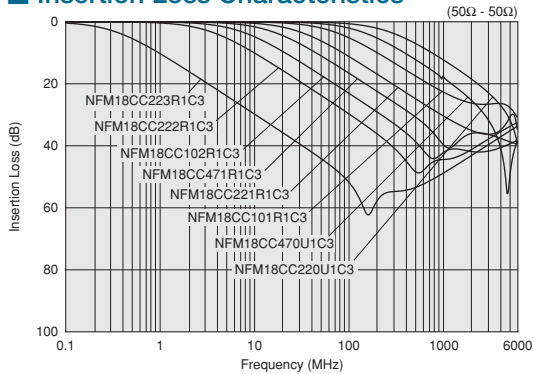

⚠Note • Please read rating and ⚠CAUTION (for storage, operating, rating, soldering, mounting and handling) in this catalog to prevent smoking and/or burning, etc.  
 • This catalog has only typical specifications. Therefore, please approve our product specifications or transact the approval sheet for product specifications before ordering.

# NFM21CC Series 0805/2012 (inch/mm)



## 0805 size general 3-terminal capacitor.



### ■ Dimensions

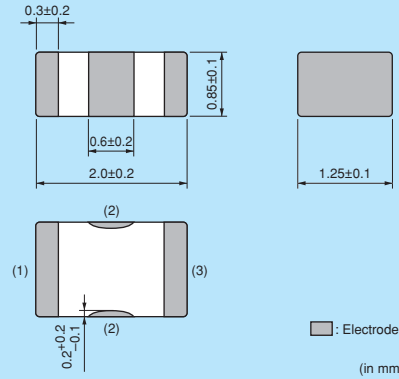

### ■ Equivalent Circuit

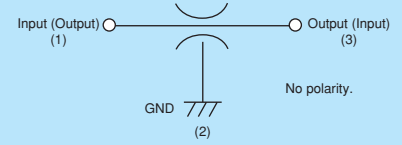

### ■ Packaging

Code	Packaging	Minimum Quantity
D	180mm Reel Paper Tape	4000
B	Bulk(Bag)	500

Refer to pages from p.156 to p.162 for mounting information.

### ■ Rated Value (□: packaging code)

Part Number	Capacitance	Rated Current	Rated Voltage	Insulation Resistance (min.)	Operating Temperature Range	
NFM21CC220U1H3□	22pF ±20%	700mA	50Vdc	1000M ohm	-55°C to +125°C	Kit
NFM21CC470U1H3□	47pF ±20%	700mA	50Vdc	1000M ohm	-55°C to +125°C	Kit
NFM21CC101U1H3□	100pF ±20%	700mA	50Vdc	1000M ohm	-55°C to +125°C	Kit
NFM21CC221R1H3□	220pF ±20%	700mA	50Vdc	1000M ohm	-55°C to +125°C	Kit
NFM21CC471R1H3□	470pF ±20%	1000mA	50Vdc	1000M ohm	-55°C to +125°C	Kit ≥1A
NFM21CC102R1H3□	1000pF ±20%	1000mA	50Vdc	1000M ohm	-55°C to +125°C	Kit ≥1A
NFM21CC222R1H3□	2200pF ±20%	1000mA	50Vdc	1000M ohm	-55°C to +125°C	Kit ≥1A
NFM21CC223R1H3□	22000pF ±20%	2000mA	50Vdc	1000M ohm	-55°C to +125°C	Kit ≥1A

Number of Circuit: 1

### ■ Insertion Loss Characteristics

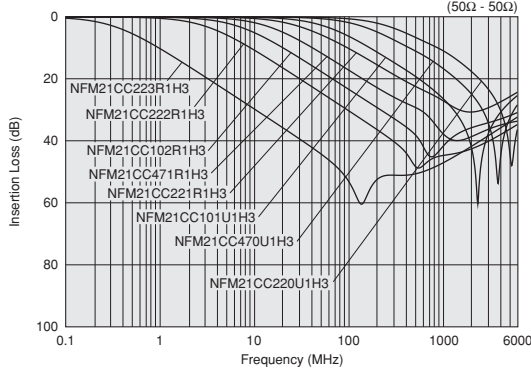

⚠Note • Please read rating and ⚠CAUTION (for storage, operating, rating, soldering, mounting and handling) in this catalog to prevent smoking and/or burning, etc.  
 • This catalog has only typical specifications. Therefore, please approve our product specifications or transact the approval sheet for product specifications before ordering.

Chip Ferrite Bead  
 Chip EMIFIL® Signal Lines Type  
 Chip Common Mode Choke Coil  
 Block Type EMIFIL®  
 Microwave Absorber

# NFM3DCC Series 1205/3212 (inch/mm)



## 1205 size general 3-terminal capacitor.



### ■ Dimensions

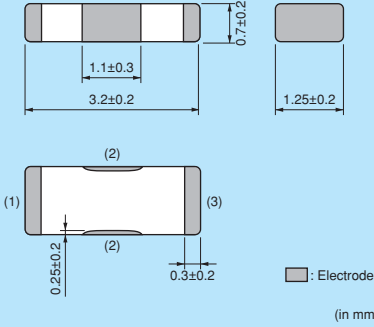

(in mm)

### ■ Equivalent Circuit

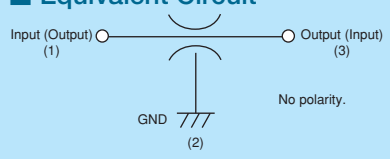

No polarity.

### ■ Packaging

Code	Packaging	Minimum Quantity
L	180mm Reel Embossed Tape	4000
B	Bulk(Bag)	500

Refer to pages from p.156 to p.162 for mounting information.

### ■ Rated Value (□: packaging code)

Part Number	Capacitance	Rated Current	Rated Voltage	Insulation Resistance (min.)	Operating Temperature Range
NFM3DCC220U1H3□	22pF +50/-20%	300mA	50Vdc	1000M ohm	-55°C to +125°C
NFM3DCC470U1H3□	47pF +50/-20%	300mA	50Vdc	1000M ohm	-55°C to +125°C
NFM3DCC101U1H3□	100pF +50/-20%	300mA	50Vdc	1000M ohm	-55°C to +125°C
NFM3DCC221R1H3□	220pF +50/-20%	300mA	50Vdc	1000M ohm	-55°C to +125°C
NFM3DCC471R1H3□	470pF +50/-20%	300mA	50Vdc	1000M ohm	-55°C to +125°C
NFM3DCC102R1H3□	1000pF +50/-20%	300mA	50Vdc	1000M ohm	-55°C to +125°C
NFM3DCC222R1H3□	2200pF +50/-20%	300mA	50Vdc	1000M ohm	-55°C to +125°C
NFM3DCC223R1H3□	22000pF +50/-20%	300mA	50Vdc	1000M ohm	-55°C to +125°C

Number of Circuit: 1

### ■ Insertion Loss Characteristics

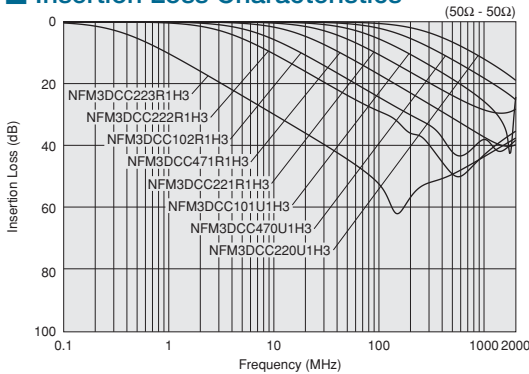

⚠Note • Please read rating and ⚠CAUTION (for storage, operating, rating, soldering, mounting and handling) in this catalog to prevent smoking and/or burning, etc.  
 • This catalog has only typical specifications. Therefore, please approve our product specifications or transact the approval sheet for product specifications before ordering.

# NFM41CC Series 1806/4516 (inch/mm)



## 1806 size general 3-terminal capacitor.



### ■ Dimensions

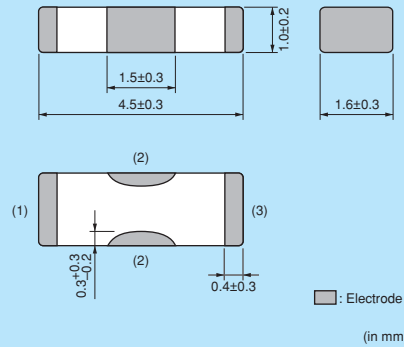

### ■ Equivalent Circuit

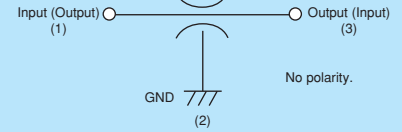

### ■ Packaging

Code	Packaging	Minimum Quantity
L	180mm Reel Embossed Tape	4000
B	Bulk(Bag)	500

Refer to pages from p.156 to p.162 for mounting information.

### ■ Rated Value (□: packaging code)

Part Number	Capacitance	Rated Current	Rated Voltage	Insulation Resistance (min.)	Operating Temperature Range
NFM41CC220U2A3□	22pF +50/-20%	300mA	100Vdc	10000M ohm	-55°C to +125°C
NFM41CC470U2A3□	47pF +50/-20%	300mA	100Vdc	10000M ohm	-55°C to +125°C
NFM41CC101U2A3□	100pF +50/-20%	300mA	100Vdc	10000M ohm	-55°C to +125°C
NFM41CC221U2A3□	220pF +50/-20%	300mA	100Vdc	10000M ohm	-55°C to +125°C
NFM41CC471R2A3□	470pF +50/-20%	300mA	100Vdc	10000M ohm	-55°C to +125°C
NFM41CC102R2A3□	1000pF +50/-20%	300mA	100Vdc	10000M ohm	-55°C to +125°C
NFM41CC222R2A3□	2200pF +50/-20%	300mA	100Vdc	10000M ohm	-55°C to +125°C
NFM41CC223R2A3□	22000pF +50/-20%	300mA	100Vdc	10000M ohm	-55°C to +125°C

Number of Circuit: 1

### ■ Insertion Loss Characteristics

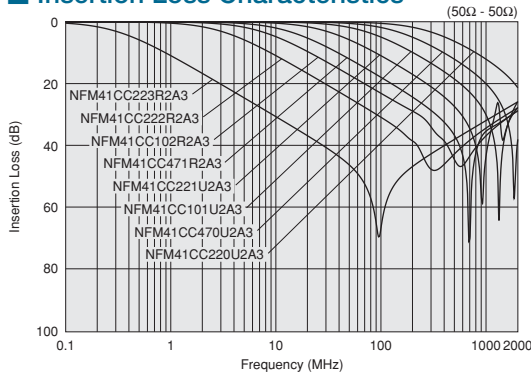

⚠ Note • Please read rating and ⚠ CAUTION (for storage, operating, rating, soldering, mounting and handling) in this catalog to prevent smoking and/or burning, etc.  
 • This catalog has only typical specifications. Therefore, please approve our product specifications or transact the approval sheet for product specifications before ordering.

Chip Ferrite Bead  
 Chip EMIFIL® Signal Lines Type  
 Chip Common Mode Choke Coil  
 Block Type EMIFIL®  
 Microwave Absorber

# NFA31CC Series 1206/3216 (inch/mm)



4-line chip 3-terminal capacitor array, 1206 size.

### ■ Dimensions

(in mm)

### ■ Equivalent Circuit

Output (Input)  
No polarity.

### ■ Packaging

Code	Packaging	Minimum Quantity
D	180mm Reel Paper Tape	4000
B	Bulk(Bag)	100

Refer to pages from p.156 to p.162 for mounting information.

### ■ Rated Value (□: packaging code)

Part Number	Capacitance	Rated Current	Rated Voltage	Insulation Resistance (min.)	Operating Temperature Range	
NFA31CC220S1E4□	22pF ±20%	200mA	25Vdc	1000M ohm	-40°C to +85°C	Kit
NFA31CC470S1E4□	47pF ±20%	200mA	25Vdc	1000M ohm	-40°C to +85°C	Kit
NFA31CC101S1E4□	100pF ±20%	200mA	25Vdc	1000M ohm	-40°C to +85°C	Kit
NFA31CC221S1E4□	220pF ±20%	200mA	25Vdc	1000M ohm	-40°C to +85°C	Kit
NFA31CC471R1E4□	470pF ±20%	200mA	25Vdc	1000M ohm	-40°C to +85°C	Kit
NFA31CC102R1E4□	1000pF ±20%	200mA	25Vdc	1000M ohm	-40°C to +85°C	Kit
NFA31CC222R1E4□	2200pF ±20%	200mA	25Vdc	1000M ohm	-40°C to +85°C	Kit
NFA31CC223R1C4□	22000pF ±20%	200mA	16Vdc	1000M ohm	-40°C to +85°C	Kit

Number of Circuit: 4

### ■ Insertion Loss Characteristics

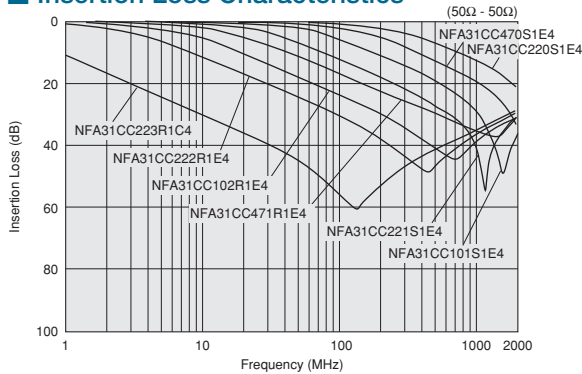

△Note • Please read rating and △CAUTION (for storage, operating, rating, soldering, mounting and handling) in this catalog to prevent smoking and/or burning, etc.  
• This catalog has only typical specifications. Therefore, please approve our product specifications or transact the approval sheet for product specifications before ordering.

# NFL15ST Series 0402/1005 (inch/mm)



T-type LC filter, ultra-compact size of 0402.



### ■ Dimensions

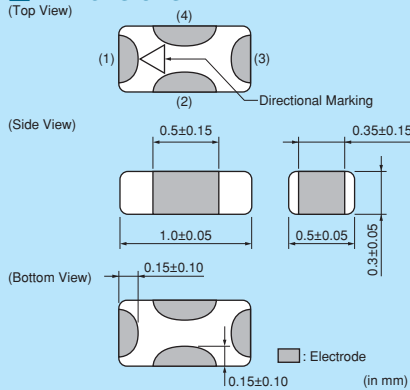

### ■ Equivalent Circuit

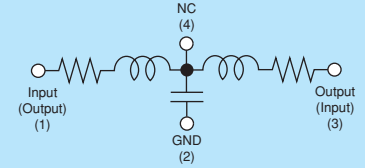

### ■ Packaging

Code	Packaging	Minimum Quantity
D	180mm Reel Paper Tape	10000
B	Bulk(Bag)	500

Refer to pages from p.156 to p.162 for mounting information.

### ■ Rated Value (□: packaging code)

Part Number	Nominal Cut-off Frequency	Capacitance	Inductance	Insertion Loss 1	Insertion Loss 2	Rated Current	Rated Voltage	
NFL15ST157X0J3□	150MHz	22pF (Typ.)	115nH (Typ.)	6dB max.(0 to 150MHz)	25dB min.(400 to 1000MHz)	50mA	6.3Vdc	Kit
NFL15ST207X0J3□	200MHz	17pF (Typ.)	105nH (Typ.)	6dB max.(0 to 200MHz)	25dB min.(600 to 1000MHz)	50mA	6.3Vdc	Kit
NFL15ST307X0J3□	300MHz	12pF (Typ.)	95nH (Typ.)	6dB max.(0 to 300MHz)	25dB min.(800 to 1000MHz)	50mA	6.3Vdc	Kit
NFL15ST507X0J3□	500MHz	7pF (Typ.)	60nH (Typ.)	6dB max.(0 to 500MHz)	25dB min.(1000MHz)	50mA	6.3Vdc	Kit

Insulation Resistance (min.): 1000M ohm    Withstand Voltage: 18.9Vdc    Operating Temperature Range: -40°C to +85°C    Number of Circuits: 1

### ■ Insertion Loss Characteristics

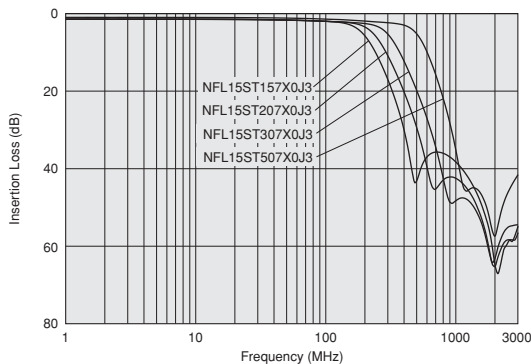

⚠Note • Please read rating and ⚠CAUTION (for storage, operating, rating, soldering, mounting and handling) in this catalog to prevent smoking and/or burning, etc.  
 • This catalog has only typical specifications. Therefore, please approve our product specifications or transact the approval sheet for product specifications before ordering.

Chip Ferrite Bead

Chip EMIFIL®  
Signal Lines Type

Chip Common Mode Choke Coil

Block Type EMIFIL®

Microwave Absorber

# NFL18ST Series 0603/1608 (inch/mm)



T-type LC filter. Reduces waveform distortion of high speed signal.

**NFL18ST\_H**

### ■ Dimensions

(Top View)

(Side View)

(Bottom View)

Legend:  Electrode (in mm)

\*1 There are no electrical polarity. But there is a directional marking on the top of product to identify inner physical direction.

### ■ Equivalent Circuit

No Polarity.

### ■ Packaging

Code	Packaging	Minimum Quantity
D	180mm Reel Paper Tape	4000
B	Bulk(Bag)	1000

**NFL18ST\_X**

### ■ Dimensions

Legend:  Electrode (in mm)

### ■ Equivalent Circuit

No Polarity.

### ■ Packaging

Code	Packaging	Minimum Quantity
D	180mm Reel Paper Tape	4000
B	Bulk(Bag)	1000

Refer to pages from p.156 to p.162 for mounting information.

### ■ Rated Value (□: packaging code)

Part Number	Nominal Cut-off Frequency	Capacitance	Inductance	Insertion Loss 1	Insertion Loss 2	Rated Current	Rated Voltage	Kit	DTV
NFL18ST506H1A3□	50MHz	110pF (Typ.)	350nH (Typ.)	6dB max.(0 to 50MHz)	30dB min.(200 to 1000MHz)	75mA	10Vdc	Kit	DTV
NFL18ST706H1A3□	70MHz	70pF (Typ.)	230nH (Typ.)	6dB max.(0 to 70MHz)	30dB min.(300 to 1000MHz)	75mA	10Vdc	Kit	DTV
NFL18ST107H1A3□	100MHz	50pF (Typ.)	150nH (Typ.)	6dB max.(0 to 100MHz)	30dB min.(400 to 1000MHz)	75mA	10Vdc	Kit	DTV
NFL18ST207H1A3□	200MHz	22pF (Typ.)	110nH (Typ.)	6dB max.(0 to 200MHz)	30dB min.(800 to 2000MHz)	100mA	10Vdc	Kit	DTV
NFL18ST307H1A3□	300MHz	16pF (Typ.)	74nH (Typ.)	6dB max.(0 to 300MHz)	30dB min.(1200 to 2000MHz)	100mA	10Vdc	Kit	
NFL18ST507H1A3□	500MHz	10pF (Typ.)	42nH (Typ.)	6dB max.(0 to 500MHz)	30dB min.(1700 to 2000MHz)	100mA	10Vdc	Kit	

Insulation Resistance (min.): 1000M ohm    Withstand Voltage: 30Vdc    Operating Temperature Range: -55°C to +125°C    Number of Circuits: 1

### ■ Insertion Loss Characteristics

#### NFL18ST\_H Series

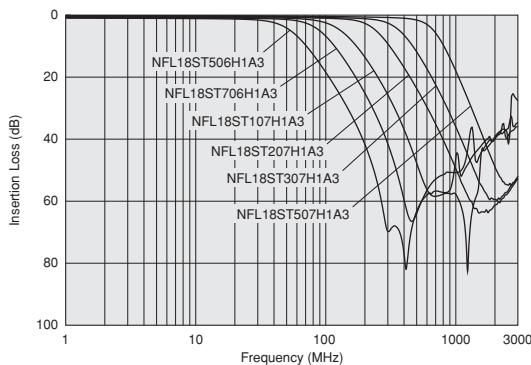

Continued on the following page.

⚠Note • Please read rating and ⚠CAUTION (for storage, operating, rating, soldering, mounting and handling) in this catalog to prevent smoking and/or burning, etc.  
• This catalog has only typical specifications. Therefore, please approve our product specifications or transact the approval sheet for product specifications before ordering.

■ Rated Value (□: packaging code)

Part Number	Nominal Cut-off Frequency	Capacitance	Inductance	Rated Current	Rated Voltage	Insulation Resistance (min.)	Withstand Voltage	Operating Temperature Range	
NFL18ST207X1C3□	200MHz	25pF±20%	110nH±20%	150mA	16Vdc	1000M ohm	50Vdc	-55°C to +125°C	Kit
NFL18ST307X1C3□	300MHz	18pF±20%	62nH±20%	200mA	16Vdc	1000M ohm	50Vdc	-55°C to +125°C	Kit
NFL18ST507X1C3□	500MHz	10pF±20%	43nH±20%	200mA	16Vdc	1000M ohm	50Vdc	-55°C to +125°C	Kit

Number of Circuits: 1

■ Insertion Loss Characteristics

NFL18ST\_X Series

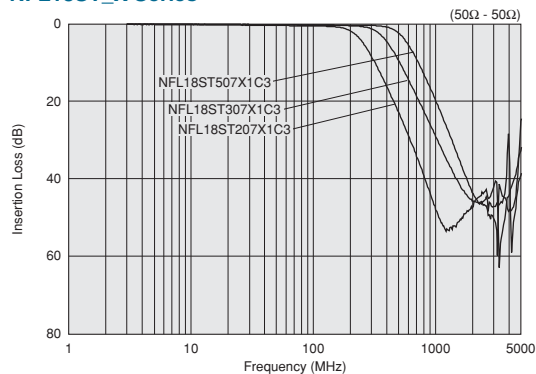

⚠Note • Please read rating and ⚠CAUTION (for storage, operating, rating, soldering, mounting and handling) in this catalog to prevent smoking and/or burning, etc.  
• This catalog has only typical specifications. Therefore, please approve our product specifications or transact the approval sheet for product specifications before ordering.



# NFL18SP Series 0603/1608 (inch/mm)



PI-type LC filter. Reduces waveform distortion of high speed signal.

### ■ Dimensions

0.15±0.1  
0.8±0.1  
1.6±0.1  
0.2 min.  
0.3±0.1 0.4±0.1 0.3±0.1 0.15±0.1 0.15±0.1 0.6±0.1

Legend:  Electrode (in mm)

### ■ Equivalent Circuit

Input (Output) (1) Output (Input) (3)  
GND (2)  
No polarity.

### ■ Packaging

Code	Packaging	Minimum Quantity
D	180mm Reel Paper Tape	4000
B	Bulk(Bag)	1000

Refer to pages from p.156 to p.162 for mounting information.

### ■ Rated Value (□: packaging code)

Part Number	Nominal Cut-off Frequency	Capacitance	Inductance	Rated Current	Rated Voltage	Insulation Resistance (min.)	Withstand Voltage	Operating Temperature Range	
NFL18SP157X1A3□	150MHz	34pF±20%	100nH±20%	100mA	10Vdc	1000M ohm	30Vdc	-55°C to +125°C	Kit
NFL18SP207X1A3□	200MHz	24pF±20%	80nH±20%	100mA	10Vdc	1000M ohm	30Vdc	-55°C to +125°C	Kit
NFL18SP307X1A3□	300MHz	19pF±20%	60nH±20%	100mA	10Vdc	1000M ohm	30Vdc	-55°C to +125°C	Kit
NFL18SP507X1A3□	500MHz	11pF±20%	38nH±20%	100mA	10Vdc	1000M ohm	30Vdc	-55°C to +125°C	Kit

Number of Circuits: 1

### ■ Insertion Loss Characteristics

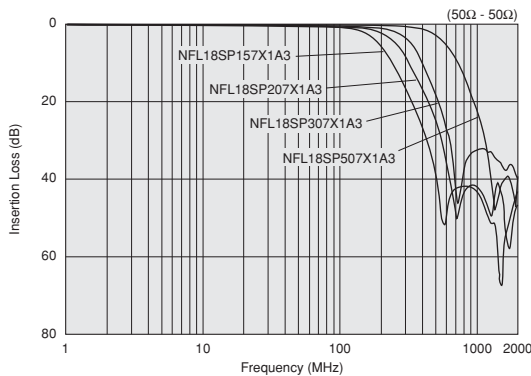

△Note • Please read rating and △CAUTION (for storage, operating, rating, soldering, mounting and handling) in this catalog to prevent smoking and/or burning, etc.  
• This catalog has only typical specifications. Therefore, please approve our product specifications or transact the approval sheet for product specifications before ordering.

# NFL21SP Series 0805/2012 (inch/mm)



PI-type LC filter. Reduces waveform distortion of high speed signal.

### ■ Dimensions

0.3±0.2    0.4±0.2  
0.85±0.1  
0.6±0.2  
2.0±0.2  
0.25±0.2  
1.25±0.1

Legend:  Electrode (in mm)

### ■ Equivalent Circuit

Input (Output) (1)    Output (Input) (3)  
GND (2)  
No polarity.

### ■ Packaging

Code	Packaging	Minimum Quantity
D	180mm Reel Paper Tape	4000
B	Bulk(Bag)	1000

Refer to pages from p.156 to p.162 for mounting information.

### ■ Rated Value (□: packaging code)

Part Number	Nominal Cut-off Frequency	Capacitance	Inductance	Rated Current	Rated Voltage	Insulation Resistance (min.)	Withstand Voltage	Operating Temperature Range	
NFL21SP106X1C3□	10MHz	670pF±20%	680nH±20%	100mA	16Vdc	1000M ohm	50Vdc	-55°C to +125°C	Kit
NFL21SP206X1C7□	20MHz	240pF±20%	700nH±20%	100mA	16Vdc	1000M ohm	50Vdc	-55°C to +125°C	Kit
NFL21SP506X1C3□	50MHz	84pF±20%	305nH±20%	150mA	16Vdc	1000M ohm	50Vdc	-55°C to +125°C	Kit
NFL21SP706X1C3□	70MHz	76pF±20%	185nH±20%	150mA	16Vdc	1000M ohm	50Vdc	-55°C to +125°C	Kit
NFL21SP107X1C3□	100MHz	44pF±20%	135nH±20%	200mA	16Vdc	1000M ohm	50Vdc	-55°C to +125°C	Kit
NFL21SP157X1C3□	150MHz	28pF±20%	128nH±20%	200mA	16Vdc	1000M ohm	50Vdc	-55°C to +125°C	Kit
NFL21SP207X1C3□	200MHz	22pF±20%	72nH±20%	250mA	16Vdc	1000M ohm	50Vdc	-55°C to +125°C	Kit
NFL21SP307X1C3□	300MHz	19pF±10%	45nH±10%	300mA	16Vdc	1000M ohm	50Vdc	-55°C to +125°C	Kit
NFL21SP407X1C3□	400MHz	16pF±10%	34nH±10%	300mA	16Vdc	1000M ohm	50Vdc	-55°C to +125°C	Kit
NFL21SP507X1C3□	500MHz	12pF±10%	31nH±10%	300mA	16Vdc	1000M ohm	50Vdc	-55°C to +125°C	Kit

Number of Circuits: 1

### ■ Insertion Loss Characteristics

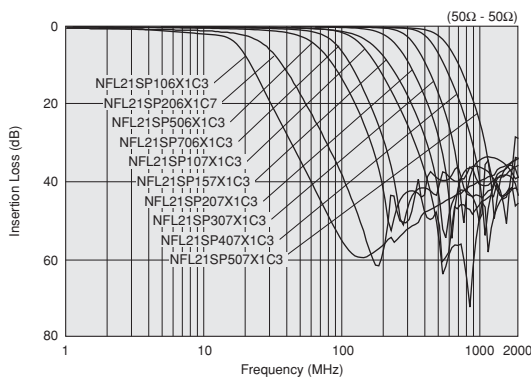

△Note • Please read rating and △CAUTION (for storage, operating, rating, soldering, mounting and handling) in this catalog to prevent smoking and/or burning, etc.  
• This catalog has only typical specifications. Therefore, please approve our product specifications or transact the approval sheet for product specifications before ordering.

Chip Ferrite Bead  
 Chip EMIFIL® Signal Lines Type  
 Chip Common Mode Choke Coil  
 Block Type EMIFIL®  
 Microwave Absorber

# NFA18SL Series 0603/1608 (inch/mm)



## LC filter 4-line array for mobile phones.

NFA18SL 137/187/207/357 V1A45  
NFA18SL506X1A45



### ■ Dimensions

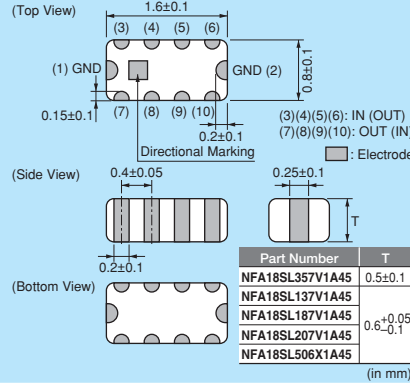

### ■ Equivalent Circuit

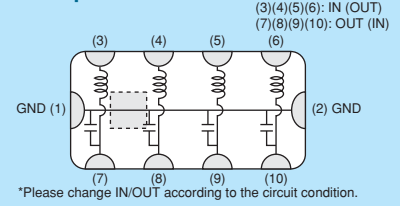

### ■ Packaging

Code	Packaging	Minimum Quantity
L	180mm Reel Embossed Tape	4000
B	Bulk(Bag)	1000

NFA18SL227V1A45



### ■ Dimensions

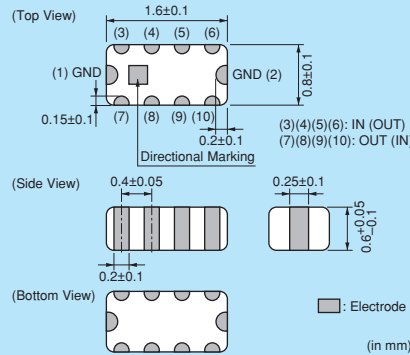

### ■ Equivalent Circuit

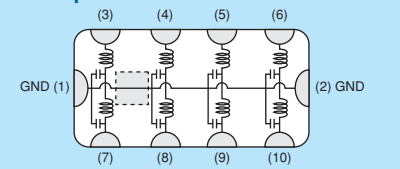

### ■ Packaging

Code	Packaging	Minimum Quantity
L	180mm Reel Embossed Tape	4000
B	Bulk(Bag)	1000

NFA18SL 307/407/487 V1A45



### ■ Dimensions

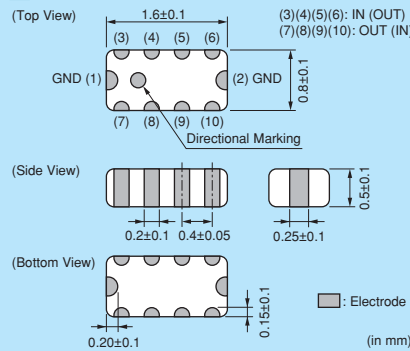

### ■ Equivalent Circuit

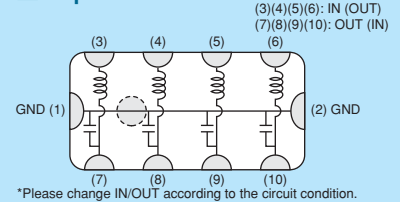

### ■ Packaging

Code	Packaging	Minimum Quantity
L	180mm Reel Embossed Tape	4000
B	Bulk(Bag)	1000

Refer to pages from p.156 to p.162 for mounting information.

### ■ Rated Value (□: packaging code)

Part Number	Nominal Cut-off Frequency	Insertion Loss (Cut-off Frequency)	Insertion Loss (470MHz) (min.)	Insertion Loss (800MHz) (min.)	Insertion Loss (900MHz) (min.)	Insertion Loss (2000MHz) (min.)	Rated Current	Rated Voltage	Insulation Resistance (min.)	Withstand Voltage	Kit	OTV
NFA18SL137V1A45□	130MHz	6dB max.	25dB	-	25dB	-	50mA	10Vdc	1000M ohm	30Vdc	Kit	OTV
NFA18SL187V1A45□	180MHz	6dB max.	20dB	-	20dB	-	50mA	10Vdc	1000M ohm	30Vdc	Kit	OTV
NFA18SL207V1A45□	200MHz	6dB max.	15dB	-	15dB	-	50mA	10Vdc	1000M ohm	30Vdc	Kit	OTV
NFA18SL227V1A45□	220MHz	6dB max.	-	-	30dB	30dB	25mA	10Vdc	1000M ohm	30Vdc	Kit	OTV
NFA18SL307V1A45□	300MHz	6dB max.	-	20dB	20dB	-	100mA	10Vdc	1000M ohm	30Vdc	Kit	
NFA18SL357V1A45□	350MHz	6dB max.	-	-	15dB	13dB	35mA	10Vdc	1000M ohm	30Vdc	Kit	
NFA18SL407V1A45□	400MHz	6dB max.	-	18dB	18dB	-	100mA	10Vdc	1000M ohm	30Vdc	Kit	
NFA18SL487V1A45□	480MHz	6dB max.	-	15dB	15dB	-	100mA	10Vdc	1000M ohm	30Vdc	Kit	

Operating Temperature Range: -40°C to +85°C (NFA18SL 137/187/207/227/357 V1A45), -55°C to +125°C (NFA18SL 307/407/487 V1A45) Number of Circuits: 4 Continued on the following page.

△Note • Please read rating and △CAUTION (for storage, operating, rating, soldering, mounting and handling) in this catalog to prevent smoking and/or burning, etc.  
• This catalog has only typical specifications. Therefore, please approve our product specifications or transact the approval sheet for product specifications before ordering.

■ Insertion Loss Characteristics

NFA18SL 137/187/207 V1A45

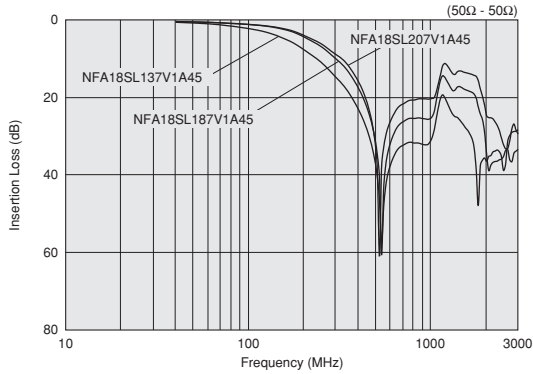

NFA18SL227V1A45

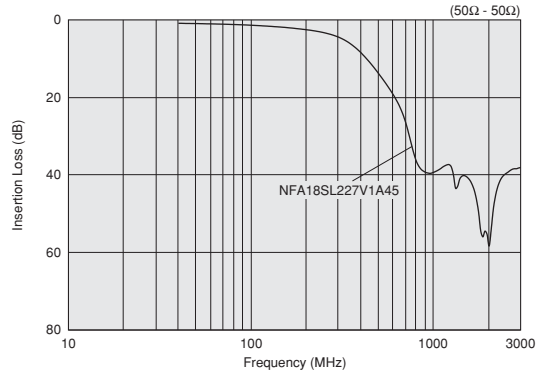

NFA18SL 307/407/487 V1A45

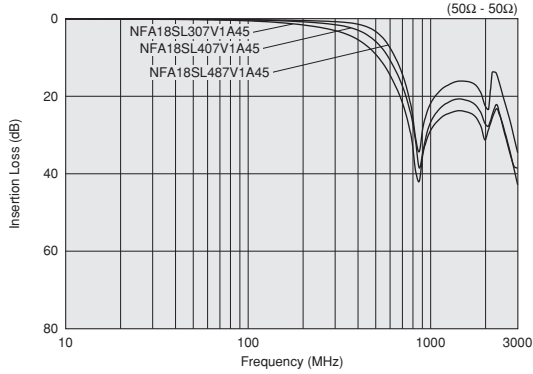

NFA18SL357V1A45

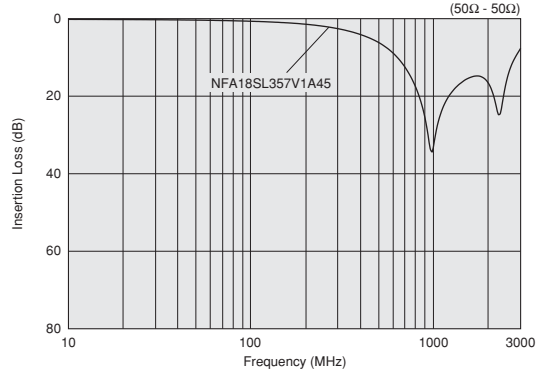

■ Rated Value (□: packaging code)

Part Number	Nominal Cut-off Frequency	Insertion Loss (Cut-off Frequency)	Insertion Loss (500MHz) (min.)	Insertion Loss (1000MHz) (min.)	Rated Current	Rated Voltage	Insulation Resistance (min.)	Withstand Voltage	
NFA18SL506X1A45□	50MHz	6dB max.	30dB	25dB	25mA	10Vdc	1000M ohm	30Vdc	Kit

Operating Temperature Range: -40°C to +85°C Number of Circuits: 4

■ Insertion Loss Characteristics

NFA18SL\_X

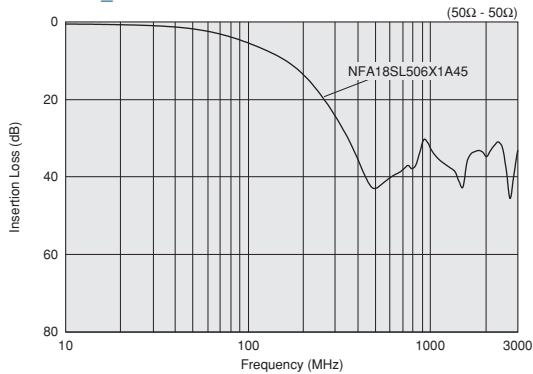

⚠Note • Please read rating and ⚠CAUTION (for storage, operating, rating, soldering, mounting and handling) in this catalog to prevent smoking and/or burning, etc.  
 • This catalog has only typical specifications. Therefore, please approve our product specifications or transact the approval sheet for product specifications before ordering.

Chip Ferrite Bead

Chip EMIFIL®  
 Signal Lines Type

Chip Common Mode Choke Coil

Block Type EMIFIL®

Microwave Absorber

# NFA18SD Series 0603/1608 (inch/mm)



For differential signal I/F of LCD or camera in mobile phones.

### ■ Dimensions

(Top View) 1.6±0.1 (3) (4) (5) (6)  
 (1) GND 0.8±0.1 GND (2)  
 0.15±0.1 (7) (8) (9) (10) 0.2±0.1  
 Directional Marking  
 (3)(4)(5)(6): IN (OUT)  
 (7)(8)(9)(10): OUT (IN)

(Side View) 0.4±0.05 0.25±0.1  
 0.6±0.06  
 0.2±0.1

(Bottom View)

■ Electrode (in mm)

### ■ Equivalent Circuit

### ■ Packaging

Code	Packaging	Minimum Quantity
L	180mm Reel Embossed Tape	4000
B	Bulk(Bag)	1000

Refer to pages from p.156 to p.162 for mounting information.

### ■ Rated Value (□: packaging code)

Part Number	Nominal Cut-off Frequency	Insertion Loss (Cut-off Frequency)	Insertion Loss (500MHz) (min.)	Insertion Loss (900MHz) (min.)	Insertion Loss (1500MHz) (min.)	Insertion Loss (2000MHz) (min.)	Rated Current	Rated Voltage	Insulation Resistance (min.)	Withstand Voltage	Kit	OTV
NFA18SD187X1A45□	180MHz	6dB max.	15dB	20dB	20dB	20dB	25mA	10Vdc	1000M ohm	30Vdc	Kit	OTV
NFA18SD207X1A45□	200MHz	6dB max.	13dB	20dB	20dB	20dB	25mA	10Vdc	1000M ohm	30Vdc	Kit	OTV

Operating Temperature Range: -40°C to +85°C Number of Circuits: 4

### ■ Insertion Loss Characteristics

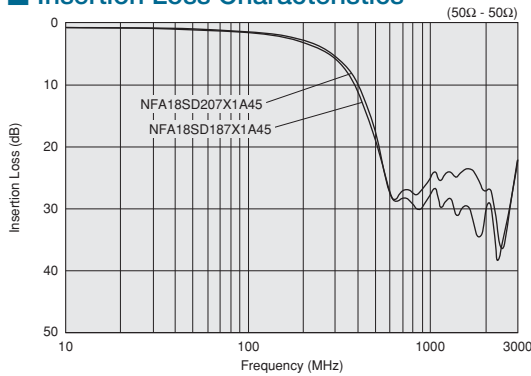

Chip Ferrite Bead

Signal Lines Type Chip EMIFIL®

Chip Common Mode Choke Coil

Block Type EMIFIL®

Microwave Absorber

△Note • Please read rating and △CAUTION (for storage, operating, rating, soldering, mounting and handling) in this catalog to prevent smoking and/or burning, etc.  
 • This catalog has only typical specifications. Therefore, please approve our product specifications or transact the approval sheet for product specifications before ordering.

# NFA21SL Series 0805/2012 (inch/mm)



L-type LC filter 4-line array for mobile phones.



### Dimensions

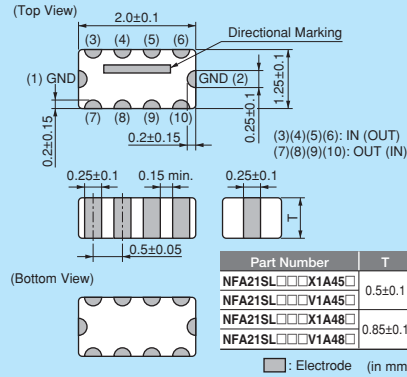

### Equivalent Circuit

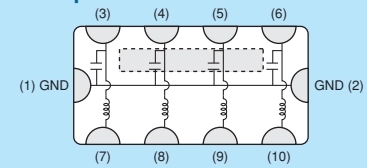

### Packaging

Code	Packaging	Minimum Quantity
L	180mm Reel Embossed Tape	4000
B	Bulk(Bag)	1000

Refer to pages from p.156 to p.162 for mounting information.

### Rated Value (□: packaging code)

Part Number	Nominal Cut-off Frequency	Insertion Loss (Cut-off Frequency)	Insertion Loss (800MHz) (min.)	Insertion Loss (900MHz) (min.)	Rated Current	Rated Voltage	Insulation Resistance (min.)	Withstand Voltage	
NFA21SL287V1A45□	280MHz	6dB max.	25dB	25dB	100mA	10Vdc	1000M ohm	30Vdc	Kit
NFA21SL317V1A45□	310MHz	6dB max.	20dB	20dB	100mA	10Vdc	1000M ohm	30Vdc	Kit
NFA21SL337V1A45□	330MHz	6dB max.	15dB	15dB	100mA	10Vdc	1000M ohm	30Vdc	Kit
NFA21SL287V1A48□	280MHz	6dB max.	25dB	25dB	100mA	10Vdc	1000M ohm	30Vdc	Kit
NFA21SL317V1A48□	310MHz	6dB max.	20dB	20dB	100mA	10Vdc	1000M ohm	30Vdc	Kit
NFA21SL337V1A48□	330MHz	6dB max.	20dB	20dB	100mA	10Vdc	1000M ohm	30Vdc	Kit

Operating Temperature Range: -55°C to +125°C Number of Circuits: 4

### Insertion Loss Characteristics

NFA21SL\_V1A45

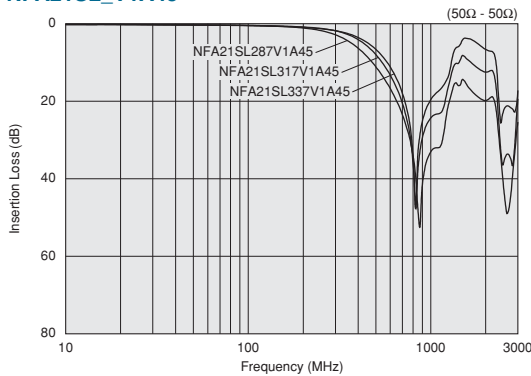

NFA21SL\_V1A48

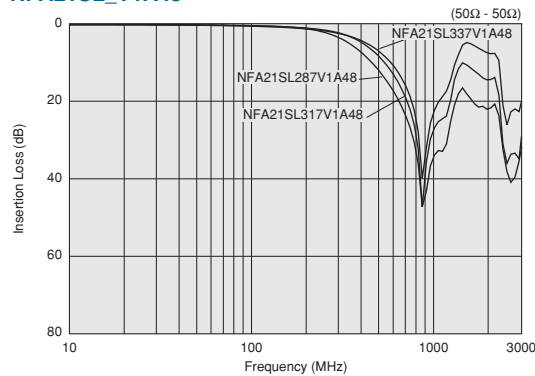

Continued on the following page. ↗

△Note • Please read rating and △CAUTION (for storage, operating, rating, soldering, mounting and handling) in this catalog to prevent smoking and/or burning, etc.  
• This catalog has only typical specifications. Therefore, please approve our product specifications or transact the approval sheet for product specifications before ordering.

Chip Ferrite Bead  
Chip EMIFIL® Signal Lines Type  
Chip Common Mode Choke Coil  
Block Type EMIFIL®  
Microwave Absorber

■ Rated Value (□: packaging code)

Part Number	Nominal Cut-off Frequency	Insertion Loss (Cut-off Frequency)	Insertion Loss (500MHz) (min.)	Insertion Loss (800MHz) (min.)	Insertion Loss (1000MHz) (min.)	Rated Current	Rated Voltage	Insulation Resistance (min.)	Withstand Voltage	
NFA21SL207X1A45□	200MHz	2dB to 7dB	13dB	25dB	25dB	100mA	10Vdc	1000M ohm	30Vdc	Kit
NFA21SL307X1A45□	300MHz	2dB to 7dB	7dB	20dB	25dB	100mA	10Vdc	1000M ohm	30Vdc	Kit
NFA21SL506X1A48□	50MHz	0dB to 6dB	30dB	-	20dB	20mA	10Vdc	1000M ohm	30Vdc	Kit
NFA21SL806X1A48□	80MHz	2dB to 7dB	25dB	-	25dB	20mA	10Vdc	1000M ohm	30Vdc	Kit
NFA21SL207X1A48□	200MHz	2dB to 7dB	13dB	25dB	25dB	100mA	10Vdc	1000M ohm	30Vdc	Kit
NFA21SL307X1A48□	300MHz	2dB to 7dB	7dB	20dB	25dB	100mA	10Vdc	1000M ohm	30Vdc	Kit

Operating Temperature Range: -55°C to +125°C Number of Circuits: 4

■ Insertion Loss Characteristics

NFA21SL\_X

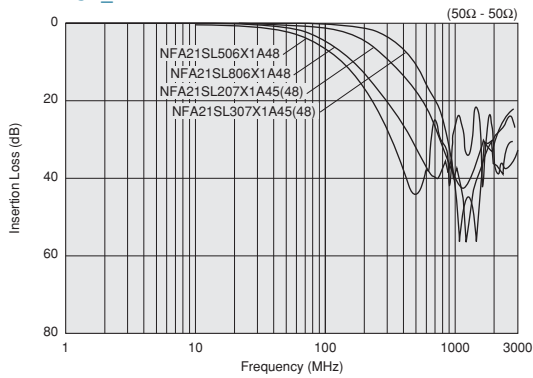

Chip Ferrite Bead

Signal Lines Type  
 Chip EMIFIL®

Chip Common Mode Choke Coil

Block Type EMIFIL®

Microwave Absorber

⚠Note • Please read rating and ⚠CAUTION (for storage, operating, rating, soldering, mounting and handling) in this catalog to prevent smoking and/or burning, etc.  
 • This catalog has only typical specifications. Therefore, please approve our product specifications or transact the approval sheet for product specifications before ordering.

# NFW31SP Series 1206/3216 (inch/mm)



## Wire-wound PI-type LC filter.



### ■ Dimensions

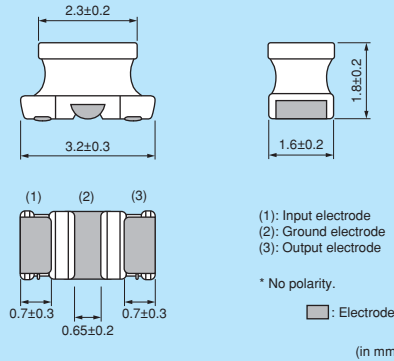

### ■ Equivalent Circuit

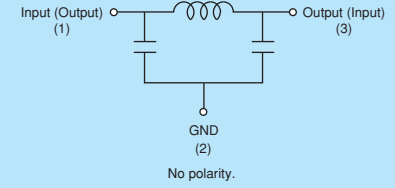

### ■ Packaging

Code	Packaging	Minimum Quantity
L	180mm Reel Embossed Tape	2000
K	330mm Reel Embossed Tape	7500

Refer to pages from p.156 to p.162 for mounting information.

### ■ Rated Value (□: packaging code)

Part Number	Nominal Cut-off Frequency	Insertion Loss at 10MHz	Insertion Loss at 20MHz	Insertion Loss at 50MHz	Insertion Loss at 100MHz	Insertion Loss at 150MHz	Insertion Loss at 200MHz	Insertion Loss at 300MHz	Insertion Loss at 400MHz	Insertion Loss at 500MHz	Insertion Loss at 1000MHz	Kit
NFW31SP106X1E4□	10MHz	6dB max.	5dB min.	25dB min.	25dB min.	-	25dB min.	-	-	30dB min.	30dB min.	Kit
NFW31SP206X1E4□	20MHz	-	6dB max.	5dB min.	25dB min.	-	25dB min.	-	-	30dB min.	30dB min.	Kit
NFW31SP506X1E4□	50MHz	-	-	6dB max.	10dB min.	-	30dB min.	-	-	30dB min.	30dB min.	Kit
NFW31SP107X1E4□	100MHz	-	-	-	6dB max.	-	5dB min.	-	-	20dB min.	30dB min.	Kit
NFW31SP157X1E4□	150MHz	-	-	-	-	6dB max.	-	10dB min.	20dB min.	30dB min.	30dB min.	Kit
NFW31SP207X1E4□	200MHz	-	-	-	-	-	6dB max.	-	-	10dB min.	30dB min.	Kit
NFW31SP307X1E4□	300MHz	-	-	-	-	-	-	6dB max.	-	5dB min.	15dB min.	Kit
NFW31SP407X1E4□	400MHz	-	-	-	-	-	-	-	6dB max.	-	10dB min.	Kit
NFW31SP507X1E4□	500MHz	-	-	-	-	-	-	-	-	6dB max.	10dB min.	Kit

Rated Current: 200mA    Rated Voltage: 25Vdc    Operating Temperature Range: -40°C to +85°C    Number of Circuit: 1

### ■ Insertion Loss Characteristics

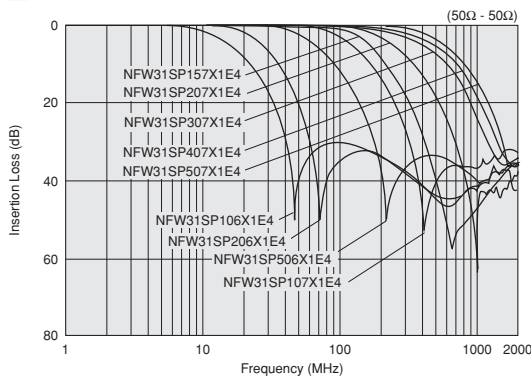

△Note • Please read rating and △CAUTION (for storage, operating, rating, soldering, mounting and handling) in this catalog to prevent smoking and/or burning, etc.  
• This catalog has only typical specifications. Therefore, please approve our product specifications or transact the approval sheet for product specifications before ordering.

Chip Ferrite Bead

Chip EMIFIL®  
Signal Lines Type

Chip Common Mode Choke Coil

Block Type EMIFIL®

Microwave Absorber



## Example of EMI Suppression in an Actual Circuit

Measuring Circuit

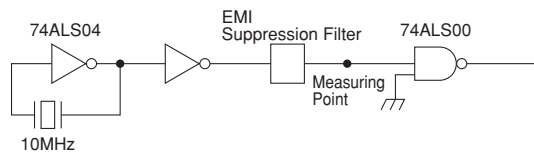

Type of Filter	Signal Wave Form (20ns/div / 1V/div) / EMI Suppression Effect / Description
Signal Waveform and Noise Spectrum before Filter Mounting	<p>Signal Waveform (20ns/div / 1V/div)</p> <p>Noise Spectrum (10:1 Active Probe)</p>
NFW31SP Series (Cut-off frequency 50MHz)	<p>NFW31SP's steep attenuation characteristic means excellent EMI suppression without waveform cornering.</p>
Conventional Chip Solid Type EMI Filter (NFM41CC 470pF)	<p>3-terminal capacitors suppress signal frequencies as EMI frequencies so the signal waveform is distorted.</p>
Filter Combined with Conventional LCs	<p>Combinations of inductors and capacitors can yield a steep attenuation characteristic, but they require a great deal more mounting space. Moreover, at high frequencies the EMI suppression is less than that obtained by NFW31S.</p>

△Note • Please read rating and △CAUTION (for storage, operating, rating, soldering, mounting and handling) in this catalog to prevent smoking and/or burning, etc.  
• This catalog has only typical specifications. Therefore, please approve our product specifications or transact the approval sheet for product specifications before ordering.

# NFR21GD Series 0805/2012 (inch/mm)



3-terminal RC filter, dampens the noise current and returns back to ground.

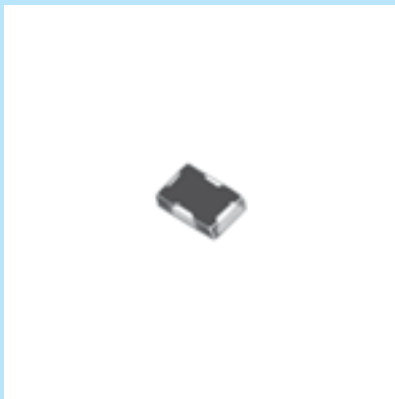

### Dimensions

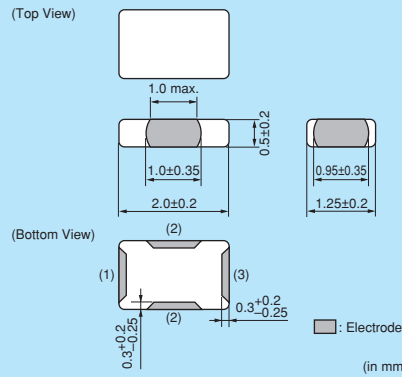

### Equivalent Circuit

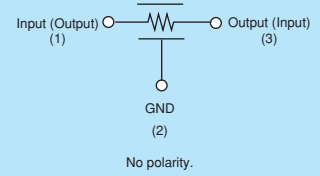

### Packaging

Code	Packaging	Minimum Quantity
L	180mm Reel Embossed Tape	4000
B	Bulk(Bag)	500

Refer to pages from p.156 to p.162 for mounting information.

### Rated Value (□: packaging code)

Part Number	Capacitance	Resistance	Rated Current	Rated Voltage	Insulation Resistance (min.)	Operating Temperature Range
NFR21GD1002202□	10pF ±20%	22ohm ±30%	50mA	50Vdc	1000M ohm	-40°C to +85°C
NFR21GD1004702□	10pF ±20%	47ohm ±30%	35mA	50Vdc	1000M ohm	-40°C to +85°C
NFR21GD4702202□	47pF ±20%	22ohm ±30%	50mA	50Vdc	1000M ohm	-40°C to +85°C
NFR21GD4704702□	47pF ±20%	47ohm ±30%	35mA	50Vdc	1000M ohm	-40°C to +85°C
NFR21GD4706802□	47pF ±20%	68ohm ±30%	30mA	50Vdc	1000M ohm	-40°C to +85°C
NFR21GD4701012□	47pF ±20%	100ohm ±30%	25mA	50Vdc	1000M ohm	-40°C to +85°C
NFR21GD1012202□	100pF ±20%	22ohm ±30%	50mA	50Vdc	1000M ohm	-40°C to +85°C
NFR21GD1014702□	100pF ±20%	47ohm ±30%	35mA	50Vdc	1000M ohm	-40°C to +85°C
NFR21GD1016802□	100pF ±20%	68ohm ±30%	30mA	50Vdc	1000M ohm	-40°C to +85°C
NFR21GD1011012□	100pF ±20%	100ohm ±30%	25mA	50Vdc	1000M ohm	-40°C to +85°C

Number of Circuit: 1

### Insertion Loss Characteristics

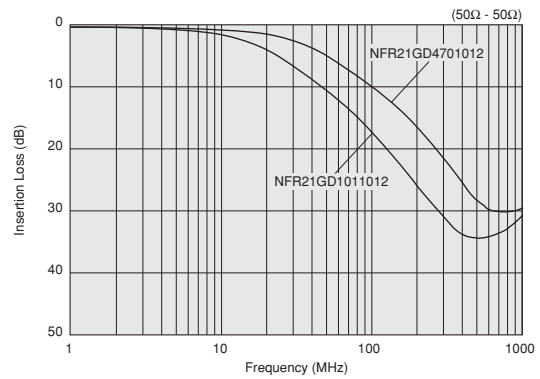
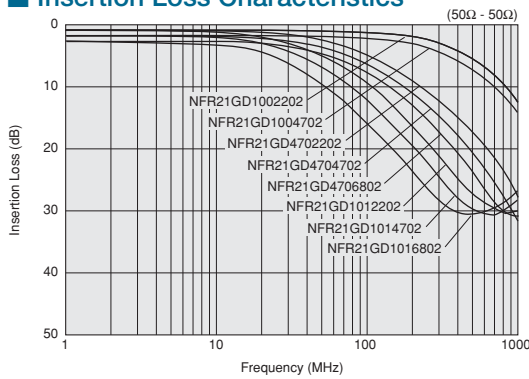

△Note • Please read rating and △CAUTION (for storage, operating, rating, soldering, mounting and handling) in this catalog to prevent smoking and/or burning, etc.  
• This catalog has only typical specifications. Therefore, please approve our product specifications or transact the approval sheet for product specifications before ordering.

Chip Ferrite Bead

Chip EMIFIL®  
Signal Lines Type

Chip Common Mode Choke Coil

Block Type EMIFIL®

Microwave Absorber

# NFA31GD Series 1206/3216 (inch/mm)



## 3-terminal RC filter array.

### ■ Dimensions

(Top View) (7) (8) (9) (10)

(Bottom View)

0.05 min. 0.05 min. (in mm)

■ Electrode

### ■ Equivalent Circuit

Input (Output)

Output (Input)  
No polarity.

### ■ Packaging

Code	Packaging	Minimum Quantity
D	180mm Reel Paper Tape	4000
B	Bulk(Bag)	100

Refer to pages from p.156 to p.162 for mounting information.

### ■ Rated Value (□: packaging code)

Part Number	Capacitance	Resistance	Rated Current	Rated Voltage	Insulation Resistance (min.)	Operating Temperature Range
NFA31GD1006R84□	10pF ±20%	6.8ohm ±40%	50mA	6Vdc	1000M ohm	-40°C to +85°C
NFA31GD1004704□	10pF ±20%	47ohm ±30%	20mA	6Vdc	1000M ohm	-40°C to +85°C
NFA31GD1001014□	10pF ±20%	100ohm ±30%	15mA	6Vdc	1000M ohm	-40°C to +85°C
NFA31GD4706R84□	47pF ±20%	6.8ohm ±40%	50mA	6Vdc	1000M ohm	-40°C to +85°C
NFA31GD4703304□	47pF ±20%	33ohm ±30%	20mA	6Vdc	1000M ohm	-40°C to +85°C
NFA31GD4704704□	47pF ±20%	47ohm ±30%	20mA	6Vdc	1000M ohm	-40°C to +85°C
NFA31GD4701014□	47pF ±20%	100ohm ±30%	15mA	6Vdc	1000M ohm	-40°C to +85°C
NFA31GD1016R84□	100pF ±20%	6.8ohm ±40%	50mA	6Vdc	1000M ohm	-40°C to +85°C
NFA31GD1014704□	100pF ±20%	47ohm ±30%	20mA	6Vdc	1000M ohm	-40°C to +85°C
NFA31GD1011014□	100pF ±20%	100ohm ±30%	15mA	6Vdc	1000M ohm	-40°C to +85°C

Number of Circuit: 4

### ■ Insertion Loss Characteristics

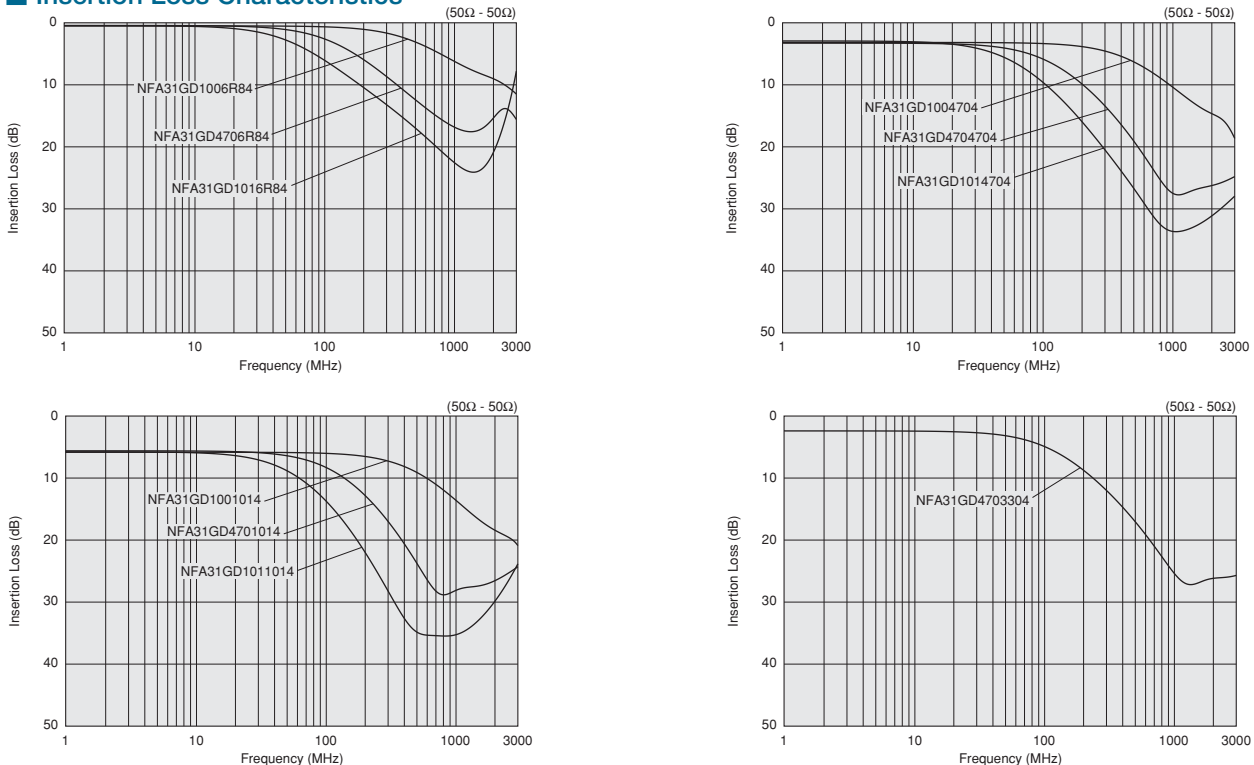

⚠ Note • Please read rating and ⚠ CAUTION (for storage, operating, rating, soldering, mounting and handling) in this catalog to prevent smoking and/or burning, etc.  
• This catalog has only typical specifications. Therefore, please approve our product specifications or transact the approval sheet for product specifications before ordering.

## ⚠ Caution

## ● Rating

Do not use products beyond the rated current and rated voltage as this may create excessive heat and deteriorate the insulation resistance.

## ● Soldering and Mounting

## 1. Self-heating

Please provide special attention when mounting chip EMIFIL® NFM□□P/K series in close proximity to other products that radiate heat.

The heat generated by other products may deteriorate the insulation resistance and cause excessive heat in this component.

## 2. NFL15ST\_X Series Mounting Direction

Mount products in right direction, because products have a direction. Wrong direction which is 180° rotated from right direction cause fuming or partial dispersion, because input or output signal terminals short-circuit to ground.

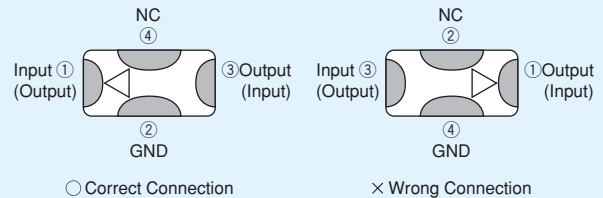

## Notice

## ● Storage and Operating Conditions

## &lt;Operating Environment&gt;

Do not use products in a chemical atmosphere such as chlorine gas, acid or sulfide gas.

Do not use products in the environment close to the organic solvent.

## &lt;Storage and Handling Requirements&gt;

## 1. Storage Period

Should be used within 12 months.

Solderability should be checked if this period is exceeded.

## 2. Storage Conditions

## (1) Storage temperature: -10 to +40°C

Relative humidity: 15 to 85%

Avoid sudden changes in temperature and humidity.

## (2) Do not store products in a chemical atmosphere such as chlorine gas, acid or sulfide gas.

## ● Notice (Soldering and Mounting)

## 1. Cleaning

Failure and degradation of a product are caused by the cleaning method. When you clean in conditions that are not in mounting information, please contact Murata engineering.

## 2. Soldering

Reliability decreases with improper soldering methods. Please solder by the standard soldering conditions shown in mounting information.

## 3. Points of Attention about NFM Pattern Forms

The loaded stresses are different to a chip depend on PCB materials and structures.

When the chip will be mounted on the metal PCB contained alumina material, PCB heat expansion/contraction will be a cause of chip cracks because the coefficients of thermal expressions are different between metal PCB and the chip itself.

In case of mounting 0402 or smaller size of NFM on single-layered glass epoxy board, chip cracks will be also occurred because of the same reason.

## 4. Component Mounting: 0402 size or smaller of NFM

If low bottom dead point of the pick-up nozzle is too low, chip cracks will be occurred because an extra power will be added to the chip during mounting. Therefore, the bottom dead point of pick-up nozzle must be set on/over the upper surface of the PCB. Adjusting is required when the bottom dead point will be set by correcting board warp. It is recommended that using the larger pick-up nozzle than chip length for avoiding what force impact will be centered to the middle point of components. Before assembling, please confirm its mounting accuracy under the best condition.

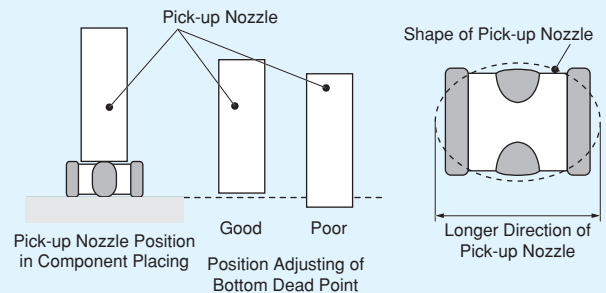

## 5. Other

Noise suppression levels resulting from Murata's EMI suppression filters EMIFIL® may vary, depending on the circuits and ICs used, type of noise, mounting pattern, mounting location, and other operating conditions. Be sure to check and confirm in advance the noise suppression effect of each filter, in actual circuits, etc. before applying the filter in a commercial-purpose equipment design.

Continued on the following page.

⚠ Note • Please read rating and ⚠ CAUTION (for storage, operating, rating, soldering, mounting and handling) in this catalog to prevent smoking and/or burning, etc.  
• This catalog has only typical specifications. Therefore, please approve our product specifications or transact the approval sheet for product specifications before ordering.

**● Handling****1. Resin Coating**

Using resin for coating/molding products may affect the products performance.

So please pay careful attention in selecting resin.

Prior to use, please make the reliability evaluation with the product mounted in your application set.

**2. Caution for Use (NFW Series)**

When you hold products with a tweezer, please hold by the sides. Sharp materials, such as a pair of tweezers or other material such as bristles of cleaning brush, should not touch the winding portion of this product to prevent breaking the wire. Mechanical shock should not be applied to the products mounted on the board to prevent breaking the core.

**3. Handling of a Substrate**

After mounting products on a substrate, do not apply any stress to the product caused by bending or twisting to the substrate when cropping the substrate, inserting and removing a connector from the substrate or tightening screw to the substrate.

Excessive mechanical stress may cause cracking in the Product.

Bending

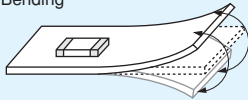

Twisting

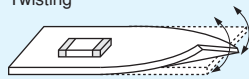

### 1. Standard Land Pattern Dimensions

NF□ series suppress noise by conducting the high-frequency noise element to ground. Therefore, to obtain maximum performance from these filters, the ground pattern should be made as large as possible during the PCB design stage. As shown below, one side of the PCB is used for chip mounting, and the other is used for grounding.

Small diameter feedthrough holes are then used to connect the grounds on each side of the PCB. This reduces the high-frequency impedance of the grounding and maximizes the filter's performance.

Land Pattern + Solder Resist  
 Land Pattern  
 Solder Resist  
 (in mm)

**NFA31CC**  
**NFA31GD**  
**NFM15CC**  
**NFM15PC**  
**NFM18CC**  
**NFM18PC**  
**NFM18PS**  
**NFM21CC**  
**NFM21PC**  
**NFM21PS**  
**NFR21GD**

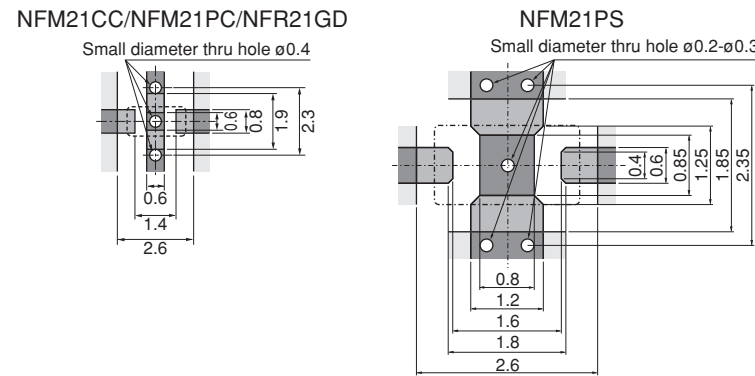
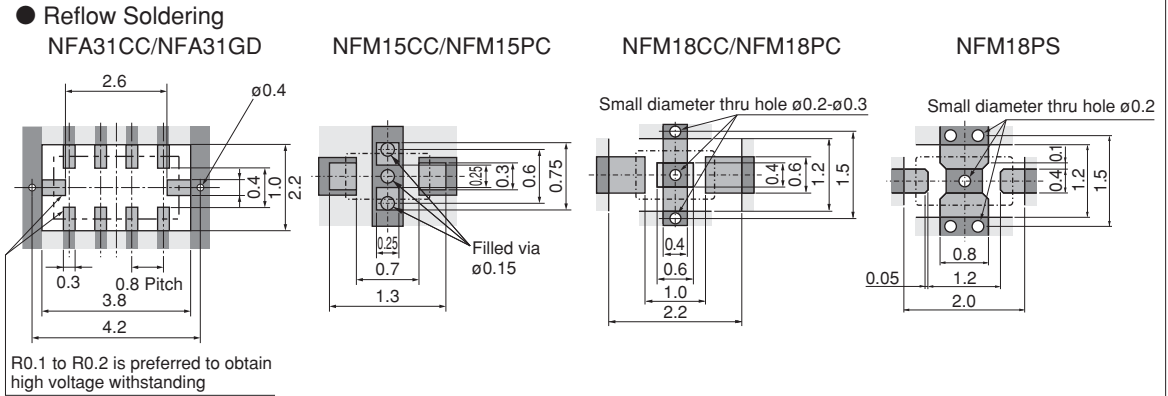

Please contact us if using thinner land pad than 18 $\mu$ m.

**NFM3DCC**  
**NFM3DPC**  
**NFM31PC**  
**NFM31KC**  
**NFM41CC**  
**NFM41PC**

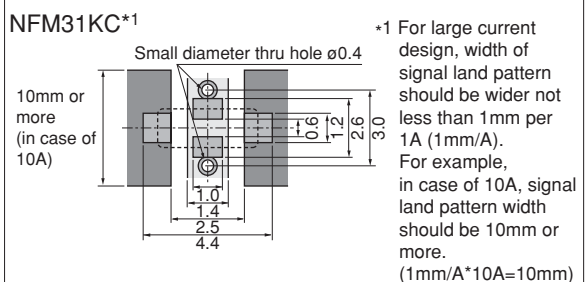
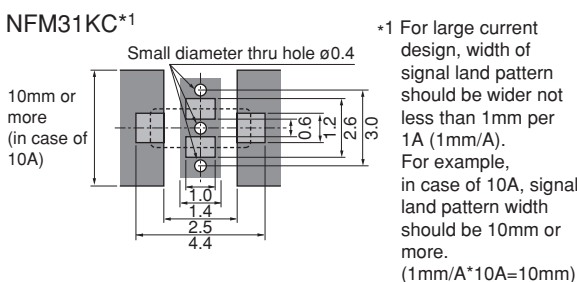
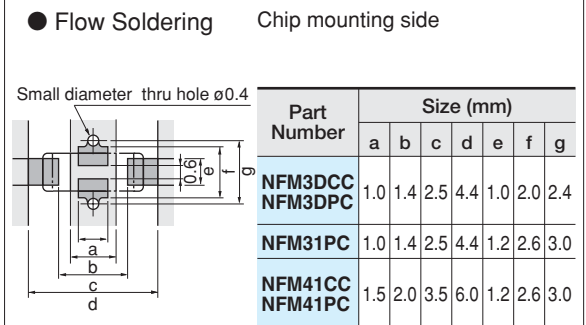
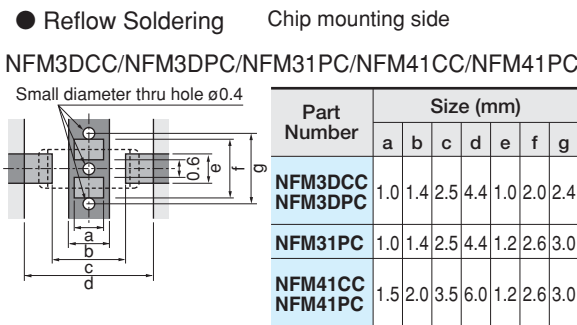

Continued on the following page.

⚠Note • Please read rating and ⚠CAUTION (for storage, operating, rating, soldering, mounting and handling) in this catalog to prevent smoking and/or burning, etc.  
 • This catalog has only typical specifications. Therefore, please approve our product specifications or transact the approval sheet for product specifications before ordering.

Land Pattern + Solder Resist  
 Land Pattern  
 Solder Resist (in mm)

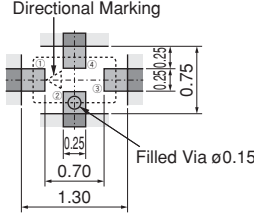
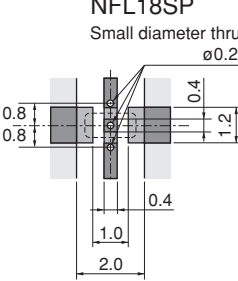
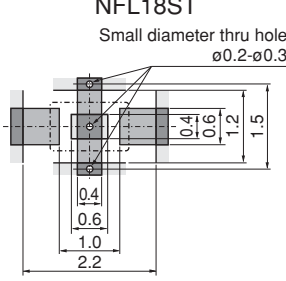
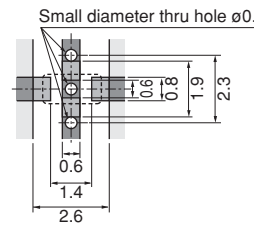
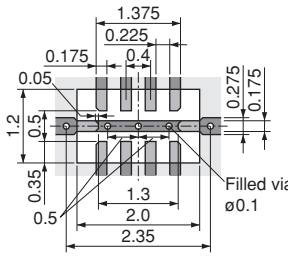
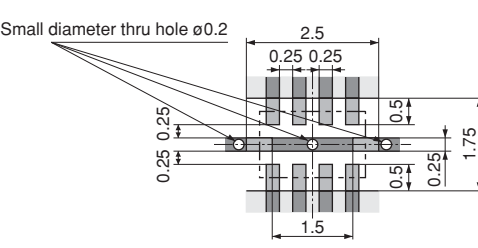
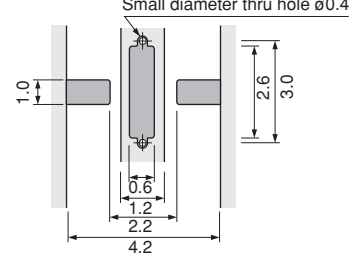
<p>NFL15ST NFL18SP NFL18ST NFL21SP</p>	<p>● Reflow Soldering NFL15ST</p>  <p>NFL18SP Small diameter thru hole ø0.2-ø0.3</p>  <p>NFL18ST Small diameter thru hole ø0.2-ø0.3</p>  <p>NFL21SP Small diameter thru hole ø0.4</p>  <p>Please contact us if using thinner land pad than 18µm.</p>
<p>NFA18SL NFA18SD NFA21SL</p>	<p>● Reflow Soldering NFA18SL/NFA18SD</p>  <p>NFA21SL Small diameter thru hole ø0.2</p> 
<p>NFW31SP NFE31PT</p>	<p>● Reflow and Flow NFW31SP ● Reflow Soldering NFE31PT</p> <p>Small diameter thru hole ø0.4</p> 

Continued on the following page.

⚠Note • Please read rating and ⚠CAUTION (for storage, operating, rating, soldering, mounting and handling) in this catalog to prevent smoking and/or burning, etc.  
 • This catalog has only typical specifications. Therefore, please approve our product specifications or transact the approval sheet for product specifications before ordering.

Land Pattern + Solder Resist  
 Land Pattern  
 Solder Resist (in mm)

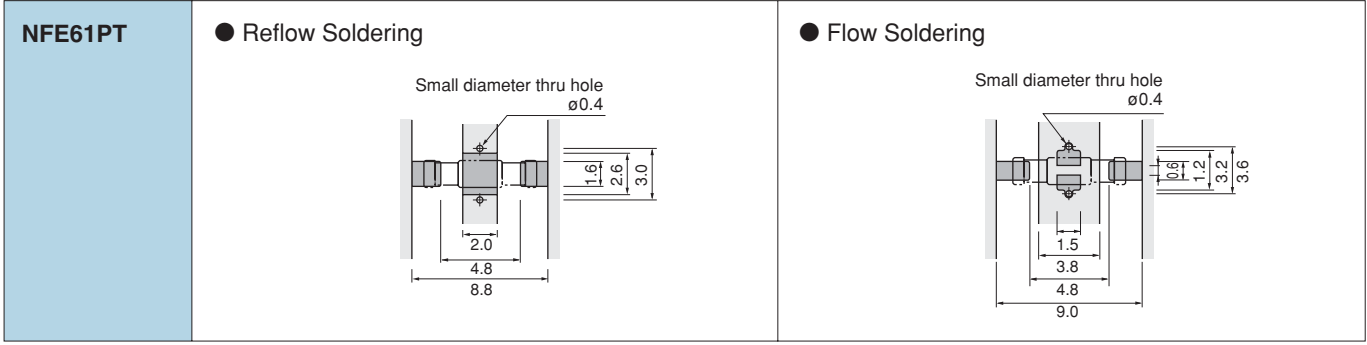

● PCB Warping  
 PCB should be designed so that products are not subjected to the mechanical stress caused by warping the board.

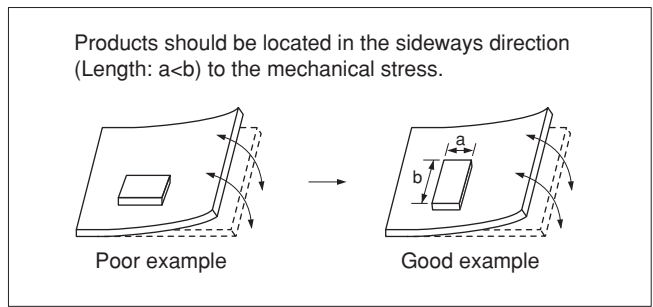

Chip Ferrite Bead

Soldering and Mounting  
Chip EMIFIL®

Chip Common Mode Choke Coil

Block Type EMIFIL®

Microwave Absorber

⚠Note • Please read rating and ⚠CAUTION (for storage, operating, rating, soldering, mounting and handling) in this catalog to prevent smoking and/or burning, etc.  
 • This catalog has only typical specifications. Therefore, please approve our product specifications or transact the approval sheet for product specifications before ordering.



2. Solder Paste Printing and Adhesive Application

When reflow soldering the chip EMI suppression filter, the printing must be conducted in accordance with the following cream solder printing conditions.

If too much solder is applied, the chip will be prone to damage by mechanical and thermal stress from the PCB and may crack.

Standard land dimensions should be used for resist and copper foil patterns.

When flow soldering the EMI suppression filter, apply the adhesive in accordance with the following conditions.

If too much adhesive is applied, then it may overflow into the land or termination areas and yield poor solderability. In contrast, if insufficient adhesive is applied, or if the adhesive is not sufficiently hardened, then the chip may become detached during flow soldering process.

(in mm)

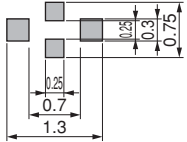
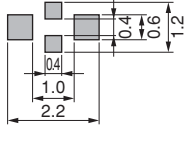
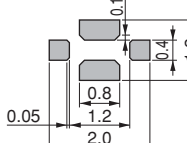
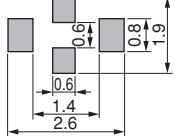
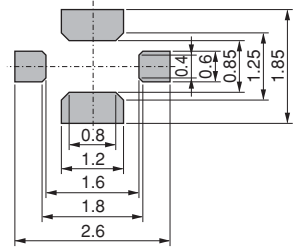
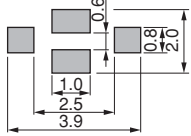
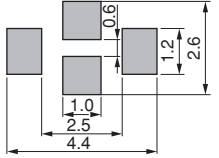
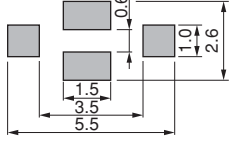
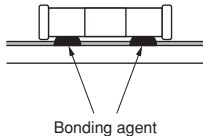
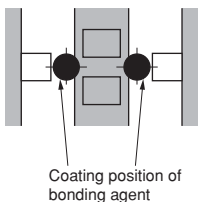
Series	Solder Paste Printing	Adhesive Application
<p><b>NFM15CC</b>  <b>NFM15PC</b>  <b>NFM18CC</b>  <b>NFM18PC</b>  <b>NFM18PS</b>  <b>NFM21CC</b>  <b>NFM21PC</b>  <b>NFM21PS</b>  <b>NFM3DCC</b>  <b>NFM3DPC</b>  <b>NFM31PC</b>  <b>NFM31KC</b>  <b>NFM41CC</b>  <b>NFM41PC</b>  <b>NFR21GD</b></p>	<p>● Guideline of solder paste thickness:                      100-150µm: NFM15/18/21/3D/31, NFR                      100-200µm: NFM41</p> <div style="display: flex; justify-content: space-around;"> <div style="text-align: center;"> <p>NFM15CC/15PC</p>  </div> <div style="text-align: center;"> <p>NFM18CC/18PC</p>  </div> </div> <div style="display: flex; justify-content: space-around; margin-top: 20px;"> <div style="text-align: center;"> <p>NFM18PS</p>  </div> <div style="text-align: center;"> <p>NFM21CC/21PC NFR21GD</p>  </div> </div> <div style="display: flex; justify-content: space-around; margin-top: 20px;"> <div style="text-align: center;"> <p>NFM21PS</p>  </div> <div style="text-align: center;"> <p>NFM3DCC/3DPC</p>  </div> </div> <div style="display: flex; justify-content: space-around; margin-top: 20px;"> <div style="text-align: center;"> <p>NFM31PC/31KC</p>  </div> <div style="text-align: center;"> <p>NFM41CC/41PC</p>  </div> </div>	<p>■ <b>NFM3D/31/41 Series</b>                      Apply 0.1mg for NFM41C/41 and 0.06mg for NFM3D/NFM31 of bonding agent at each chip. Do not cover electrodes.</p> <div style="display: flex; justify-content: space-around; align-items: center;">   </div>

Continued on the following page. ↗

⚠ Note • Please read rating and ⚠ CAUTION (for storage, operating, rating, soldering, mounting and handling) in this catalog to prevent smoking and/or burning, etc.  
 • This catalog has only typical specifications. Therefore, please approve our product specifications or transact the approval sheet for product specifications before ordering.

(in mm)

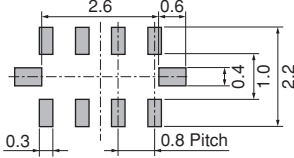
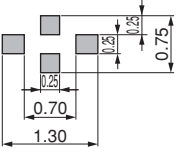
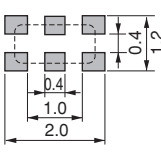
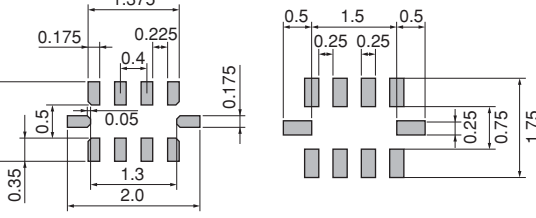
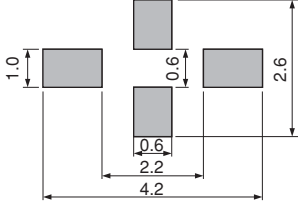
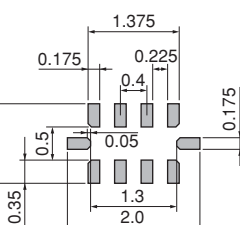
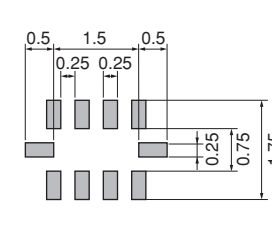
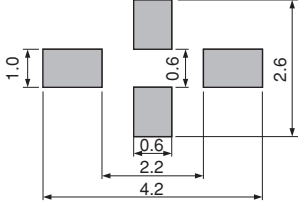
Series	Solder Paste Printing	Adhesive Application
<p><b>NFA31CC</b> <b>NFA31GD</b></p>	<p>●Guideline of solder paste thickness: 100-200µm: NFA31CC/31GD NFA31CC/31GD</p> 	
<p><b>NFL15ST</b> <b>NFL18SP</b> <b>NFL18ST</b> <b>NFL21SP</b> <b>NFA18SL</b> <b>NFA18SD</b> <b>NFA21SL</b></p>	<p>●Guideline of solder paste thickness: 100-150µm: NFL, NFA18SL/18SD/21SL</p> <p><b>NFL15ST</b>      <b>NFL18SP</b></p>  <p><b>NFL18ST</b>      <b>NFL21SP</b></p>  <p><b>NFA18SL/18SD</b>      <b>NFA21SL</b></p> 	
<p><b>NFW31SP</b> <b>NFE31PT</b></p>	<p>●Guideline of solder paste thickness: 150-200µm</p> 	<p>■ <b>NFW31SP Series</b> Apply 0.2mg of bonding agent at each chip.</p> 
<p><b>NFE61PT</b></p>	<p>●Guideline of solder paste thickness: 150-200µm</p> 	<p>Apply 1.0mg of bonding agent at each chip.</p> 

△Note • Please read rating and △CAUTION (for storage, operating, rating, soldering, mounting and handling) in this catalog to prevent smoking and/or burning, etc.  
• This catalog has only typical specifications. Therefore, please approve our product specifications or transact the approval sheet for product specifications before ordering.

Chip Ferrite Bead  
Soldering and Mounting  
Chip EMIFIL®  
Chip Common Mode Choke Coil  
Block Type EMIFIL®  
Microwave Absorber

3. Standard Soldering Conditions

(1) Soldering Methods

Use flow and reflow soldering methods only.  
 Use standard soldering conditions when soldering chip EMI suppression filters.  
 In cases where several different parts are soldered, each having different soldering conditions, use those conditions requiring the least heat and minimum time.

Solder: Use Sn-3.0Ag-0.5Cu solder. Use of Sn-Zn based solder will deteriorate performance of products.  
 If using NFM series with Sn-Zn based solder, please contact Murata in advance.

Flux:

- Use Rosin-based flux.  
 In case of using RA type solder, products should be cleaned completely with no residual flux.
- Do not use strong acidic flux (with chlorine content exceeding 0.20wt%)
- Do not use water-soluble flux.

For additional mounting methods, please contact Murata.

(2) Soldering Profile

● Flow Soldering Profile (Sn-3.0Ag-0.5Cu Solder)

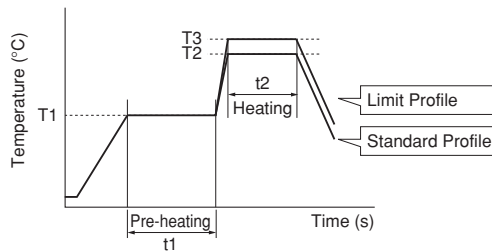

Series	Pre-heating		Standard Profile			Limit Profile		
	Temp. (T1)	Time. (t1)	Heating		Cycle of Flow	Heating		Cycle of Flow
			Temp. (T2)	Time. (t2)		Temp. (T3)	Time. (t2)	
NFM3D/31/41	150°C	60s min.	250°C	4 to 6s	2 times max.	265±3°C	5s max.	2 times max.
NFE61PT	150°C	60s min.	250°C	4 to 6s	2 times max.	265±3°C	5s max.	2 times max.
NFW31SP	150°C	60s min.	250°C	4 to 6s	2 times max.	265±3°C	5s max.	1 time max.

● Reflow Soldering Profile (Sn-3.0Ag-0.5Cu Solder)

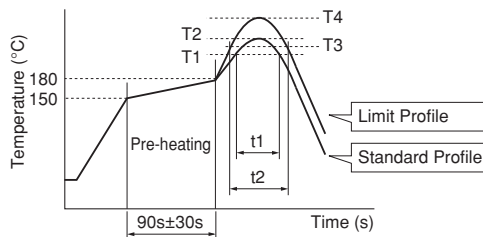

Series	Standard Profile				Limit Profile			
	Heating		Peak Temperature (T2)	Cycle of Reflow	Heating		Peak Temperature (T4)	Cycle of Reflow
	Temp. (T1)	Time. (t1)			Temp. (T3)	Time. (t2)		
NFM NFA31CC/31GD, NFR	220°C min.	30 to 60s	245±3°C	2 times max.	230°C min.	60s max.	260°C/10s	2 times max.
NFA18S/21S (Except for NFA31CC/31GD) NFE, NFL	220°C min.	30 to 60s	245±3°C	2 times max.	230°C min.	60s max.	260°C/10s	2 times max.
NFW31SP	220°C min.	30 to 60s	245±3°C	2 times max.	230°C min.	60s max.	260°C/10s	1 time max.

△Note • Please read rating and △CAUTION (for storage, operating, rating, soldering, mounting and handling) in this catalog to prevent smoking and/or burning, etc.  
 • This catalog has only typical specifications. Therefore, please approve our product specifications or transact the approval sheet for product specifications before ordering.

## (3) Reworking with Solder Iron

The following conditions must be strictly followed when using a soldering iron.

Pre-heating: 150°C 60s min.

Soldering iron power output / Tip diameter:

30W max. / ø3mm max.\*<sup>1</sup>

\*<sup>1</sup> NFM15: 30W max. / ø2mm max.

Temperature of soldering iron tip / Soldering time / Times:

350°C max. / 3-4s / 2 times\*<sup>2</sup>

\*<sup>2</sup> NFM15: 340°C max. / 3-4s / 1 time

NFE31PT152Z1E9: 280°C max. / 10s max. / 2 times

Do not allow the tip of the soldering iron to directly contact the chip.

For additional methods of reworking with a soldering iron, please contact Murata engineering.

## 4. Cleaning

Following conditions should be observed when cleaning chip EMI filter.

(1) Cleaning Temperature: 60°C max. (40°C max. for alcohol type cleaner)

(2) Ultrasonic

Output: 20W/liter max.

Duration: 5 minutes max.

Frequency: 28 to 40kHz

(3) Cleaning Agent

The following list of cleaning agents have been tested on the individual components. Evaluation of final assembly should be completed prior to production.

(a) Alcohol cleaning agent

Isopropyl alcohol (IPA)

(b) Aqueous cleaning agent

Pine Alpha ST-100S

(4) Ensure that flux residue is completely removed.

Component should be thoroughly dried after aqueous agent has been removed with deionized water.

⚠Note • Please read rating and ⚠CAUTION (for storage, operating, rating, soldering, mounting and handling) in this catalog to prevent smoking and/or burning, etc.  
• This catalog has only typical specifications. Therefore, please approve our product specifications or transact the approval sheet for product specifications before ordering.

## Minimum Quantity and Dimensions of 8mm Width Paper / Embossed Tape

(Paper Tape)

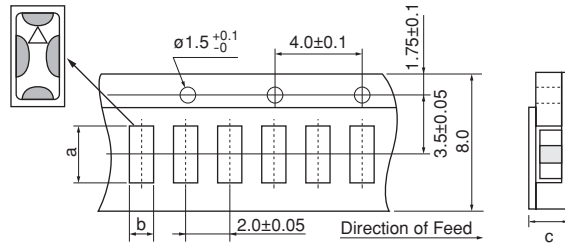

c: Total Thickness of Tape

Part Number	Dimensions				Minimum Qty. (pcs.)				Bulk
					ø180mm Reel		ø330mm Reel		
	a	b	c	d	Paper Tape	Embossed Tape	Paper Tape	Embossed Tape	
NFL15ST	1.12	0.62	0.8 max.	-	10000	-	-	-	500

(in mm)

(Common to Paper Tape / Embossed Tape)

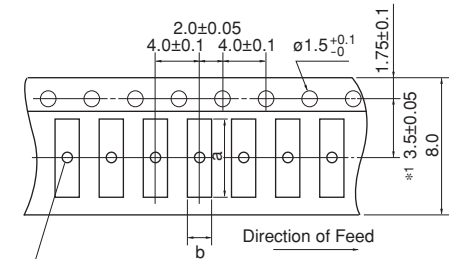

<Embossed>

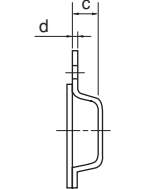

c: Depth of Cavity (Embossed Tape)

<Paper>



c: Total Thickness of Tape (Paper Tape)

(There are holes in the cavities of the NFM31, NFA18S and NFA21S\_48 only.  
NFA18S:  $\phi 0.8 \pm 0.1$ , NFA21S\_48:  $\phi 1.0 \pm 0.2$   
NFM31:  $\phi 1.0 \pm 0.2$ )

\*1 NFM31:  $3.5 \pm 0.1$

Dimension of the cavity of embossed tape is measured at the bottom side.

Part Number	Dimensions				Minimum Qty. (pcs.)				Bulk
					ø180mm Reel		ø330mm Reel		
	a	b	c	d	Paper Tape	Embossed Tape	Paper Tape	Embossed Tape	
NFM15CC/ NFM15PC (Except for 474/105)	1.15	0.75	0.75 max.	-	10000	-	-	-	500
NFM15PC474/105	1.15	0.65	0.6 max.	-	10000	-	-	-	500
NFM18CC/ NFM18PC (Except for 105R/225B1A) NFM18PS	1.85	1.05	0.9 max.	-	4000	-	-	-	500
NFM18PC105R/225B1A			1.1 max.	-	4000	-	-	-	500
NFL18SP/NFL18ST_H	1.85	1.05	0.9 max.	-	4000	-	-	-	1000
NFL18ST_X			1.1 max.						
NFL21SP	2.3	1.55	1.1 max.	-	4000	-	-	-	500
NFM21CC/21PC/21PS	2.3	1.55	1.1 max.	-	-	4000	-	-	500
NFM3DCC/3DPC	3.4	1.4	0.85	0.2	-	4000	-	-	500
NFM31PC/31KC	3.5	1.9	1.5	0.25	-	3000	-	-	500
NFA18SL/18SD	1.8	1.0	0.7	0.25	-	4000	-	-	1000
NFA21SL_45	2.30	1.55	0.7	0.25	-	4000	-	-	1000
NFA21SL_48	2.25	1.45	1.05	0.25	-	4000	-	-	1000
NFA31GD/31CC	3.5	2.0	1.1 max.	-	4000	-	-	-	100
NFE31PT	3.6	1.8	1.85	0.2	-	2000	-	8000	500
NFR21GD	2.3	1.55	0.7	0.25	-	4000	-	-	500
NFW31SP	3.6	1.9	2.0	0.2	-	2000	-	7500	-

(in mm)

"Minimum Quantity" means the number of units of each delivery or order. The quantity should be an integral multiple of the "Minimum Quantity."

Continued on the following page. 

**Note** • Please read rating and **CAUTION** (for storage, operating, rating, soldering, mounting and handling) in this catalog to prevent smoking and/or burning, etc.  
• This catalog has only typical specifications. Therefore, please approve our product specifications or transact the approval sheet for product specifications before ordering.

■ Minimum Quantity and Dimensions of 12mm Width Embossed Tape

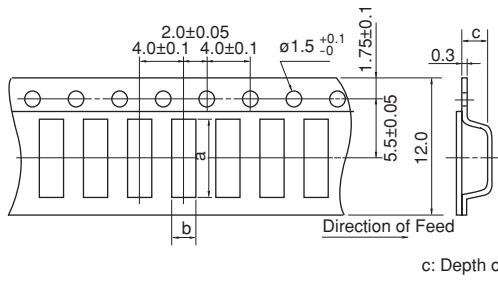

Part Number	Dimensions			Minimum Qty. (pcs.)		
	a	b	c	ø180mm Reel	ø330mm Reel	Bulk
NFM41CC/41PC	4.8	1.8	1.1	4000	-	500
NFE61PT	7.2	1.9	1.75	2500	8000	500

Dimension of the cavity is measured at the bottom side.

(in mm)

"Minimum Quantity" means the number of units of each delivery or order. The quantity should be an integral multiple of the "Minimum Quantity."

△Note • Please read rating and △CAUTION (for storage, operating, rating, soldering, mounting and handling) in this catalog to prevent smoking and/or burning, etc.  
 • This catalog has only typical specifications. Therefore, please approve our product specifications or transact the approval sheet for product specifications before ordering.

Chip Ferrite Bead  
Packaging Chip EMIFIL®  
Chip Common Mode Choke Coil  
Block Type EMIFIL®  
Microwave Absorber

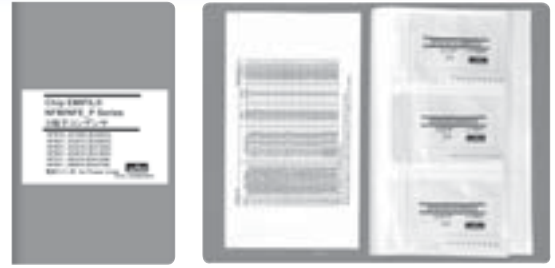

### ●EKEMNFMCC-KIT (Chip EMIFIL® Capacitor Type for Signal Lines)

No.	Part Number	Quantity (pcs.)	Capacitance	Rated Voltage (Vdc)	Rated Current (mA)
1	NFM15CC222D1A3	10	2200pF±20%	10	1000
2	NFM15CC222D1C3	10	2200pF±20%	16	1000
3	NFM15CC223C1A3	10	22000pF±20%	10	1000
4	NFM15CC223C1C3	10	22000pF±20%	16	1000
5	NFM18CC220U1C3	10	22pF±20%	16	400
6	NFM18CC470U1C3	10	47pF±20%	16	400
7	NFM18CC101R1C3	10	100pF±20%	16	500
8	NFM18CC221R1C3	10	220pF±20%	16	500
9	NFM18CC471R1C3	10	470pF±20%	16	500
10	NFM18CC102R1C3	10	1000pF±20%	16	600
11	NFM18CC222R1C3	10	2200pF±20%	16	700
12	NFM18CC223R1C3	10	22000pF±20%	16	1000
13	NFM21CC220U1H3	10	22pF±20%	50	700
14	NFM21CC470U1H3	10	47pF±20%	50	700
15	NFM21CC101U1H3	10	100pF±20%	50	700
16	NFM21CC221R1H3	10	220pF±20%	50	700
17	NFM21CC471R1H3	10	470pF±20%	50	1000
18	NFM21CC102R1H3	10	1000pF±20%	50	1000
19	NFM21CC222R1H3	10	2200pF±20%	50	1000
20	NFM21CC223R1H3	10	22000pF±20%	50	2000

### ●EKEMFA31E-KIT (Chip EMIFIL® Capacitor Array Type / RC Combined Array Type)

No.	Part Number	Quantity (pcs.)	Capacitance	Rated Voltage (Vdc)	Rated Current (mA)
1	NFA31CC220S1E4	10	22pF±20%	25	200
2	NFA31CC470S1E4	10	47pF±20%	25	200
3	NFA31CC101S1E4	10	100pF±20%	25	200
4	NFA31CC221S1E4	10	220pF±20%	25	200
5	NFA31CC471R1E4	10	470pF±20%	25	200
6	NFA31CC102R1E4	10	1000pF±20%	25	200
7	NFA31CC222R1E4	10	2200pF±20%	25	200
8	NFA31CC223R1C4	10	22000pF±20%	16	200

### ●EKEMFL18AG-KIT (Chip EMIFIL® LC Combined Type)

No.	Part Number	Quantity (pcs.)	Cut-off Frequency	Rated Voltage (Vdc)	Rated Current (mA)
1	NFL15ST157X0J3	10	150MHz	6.3	50
2	NFL15ST207X0J3	10	200MHz	6.3	50
3	NFL15ST307X0J3	10	300MHz	6.3	50
4	NFL15ST507X0J3	10	500MHz	6.3	50
5	NFL18ST506H1A3	10	50MHz	10	75
6	NFL18ST706H1A3	10	70MHz	10	75
7	NFL18ST107H1A3	10	100MHz	10	75
8	NFL18ST207H1A3	10	200MHz	10	100
9	NFL18ST307H1A3	10	300MHz	10	100
10	NFL18ST507H1A3	10	500MHz	10	100
11	NFL18ST207X1C3	10	200MHz	16	150
12	NFL18ST307X1C3	10	300MHz	16	200
13	NFL18ST507X1C3	10	500MHz	16	200
14	NFL18SP157X1A3	10	150MHz	10	100
15	NFL18SP207X1A3	10	200MHz	10	100
16	NFL18SP307X1A3	10	300MHz	10	100
17	NFL18SP507X1A3	10	500MHz	10	100
18	NFL21SP106X1C3	10	10MHz	16	100
19	NFL21SP206X1C7	10	20MHz	16	100

Continued on the following page.

⚠Note • Please read rating and ⚠CAUTION (for storage, operating, rating, soldering, mounting and handling) in this catalog to prevent smoking and/or burning, etc.  
• This catalog has only typical specifications. Therefore, please approve our product specifications or transact the approval sheet for product specifications before ordering.

Continued from the preceding page.

No.	Part Number	Quantity (pcs.)	Cut-off Frequency	Rated Voltage (Vdc)	Rated Current (mA)
20	NFL21SP506X1C3	10	50MHz	16	150
21	NFL21SP706X1C3	10	70MHz	16	150
22	NFL21SP107X1C3	10	100MHz	16	200
23	NFL21SP157X1C3	10	150MHz	16	200
24	NFL21SP207X1C3	10	200MHz	16	250
25	NFL21SP307X1C3	10	300MHz	16	300
26	NFL21SP407X1C3	10	400MHz	16	300
27	NFL21SP507X1C3	10	500MHz	16	300

No.	Part Number	Quantity (pcs.)	Cut-off Frequency	Attenuation (dB min.)										Rated Current	Rated Voltage
				10MHz	20MHz	50MHz	100MHz	150MHz	200MHz	300MHz	400MHz	500MHz	1GHz		
28	NFW31SP106X1E4	10	10MHz	6dB max.	5	25	25	-	25	-	-	30	30	200mA	25V
29	NFW31SP206X1E4	10	20MHz	-	6dB max.	5	25	-	25	-	-	30	30	200mA	25V
30	NFW31SP506X1E4	10	50MHz	-	-	6dB max.	10	-	30	-	-	30	30	200mA	25V
31	NFW31SP107X1E4	10	100MHz	-	-	-	6dB max.	-	5	-	-	20	30	200mA	25V
32	NFW31SP157X1E4	10	150MHz	-	-	-	-	6dB max.	-	10	20	30	30	200mA	25V
33	NFW31SP207X1E4	10	200MHz	-	-	-	-	-	6dB max.	-	-	10	30	200mA	25V
34	NFW31SP307X1E4	10	300MHz	-	-	-	-	-	-	6dB max.	-	5	15	200mA	25V
35	NFW31SP407X1E4	10	400MHz	-	-	-	-	-	-	-	6dB max.	-	10	200mA	25V
36	NFW31SP507X1E4	10	500MHz	-	-	-	-	-	-	-	-	6dB max.	10	200mA	25V

●EKEMFA20AH-KIT (Chip EMIFIL® LC Combined Array Type)

No.	Part Number	Quantity (pcs.)	Cut-off Frequency	Rated Voltage (Vdc)	Rated Current (mA)
1	NFA18SL506X1A45	10	50MHz	10	25
2	NFA18SL137V1A45	10	130MHz	10	50
3	NFA18SL187V1A45	10	180MHz	10	50
4	NFA18SL207V1A45	10	200MHz	10	50
5	NFA18SL227V1A45	10	220MHz	10	25
6	NFA18SL307V1A45	10	300MHz	10	100
7	NFA18SL357V1A45	10	350MHz	10	35
8	NFA18SL407V1A45	10	400MHz	10	100
9	NFA18SL487V1A45	10	480MHz	10	100
10	NFA18SD187X1A45	10	180MHz	10	25
11	NFA18SD207X1A45	10	200MHz	10	25
12	NFA21SL506X1A48	10	50MHz	10	20
13	NFA21SL806X1A48	10	80MHz	10	20
14	NFA21SL207X1A45	10	200MHz	10	100
15	NFA21SL207X1A48	10	200MHz	10	100
16	NFA21SL307X1A45	10	300MHz	10	100
17	NFA21SL307X1A48	10	300MHz	10	100
18	NFA21SL287V1A45	10	280MHz	10	100
19	NFA21SL287V1A48	10	280MHz	10	100
20	NFA21SL317V1A45	10	310MHz	10	100
21	NFA21SL317V1A48	10	310MHz	10	100
22	NFA21SL337V1A45	10	330MHz	10	100
23	NFA21SL337V1A48	10	330MHz	10	100

●EKEMNFPAN-KIT (Chip EMIFIL® for Large Current)

No.	Part Number	Quantity (pcs.)	Capacitance	Rated Voltage (Vdc)	Rated Current (A)
1	NFM15CC222D1A3	10	2200pF±20%	10	1
2	NFM15CC222D1C3	10	2200pF±20%	16	1
3	NFM15CC223C1A3	10	22000pF±20%	10	1
4	NFM15CC223C1C3	10	22000pF±20%	16	1
5	NFM15PC473C1A3	10	0.047μF±20%	10	1
6	NFM15PC473C1C3	10	0.047μF±20%	16	1
7	NFM15PC104D0J3	10	0.1μF±20%	6.3	2
8	NFM15PC104R1A3	10	0.1μF±20%	10	2
9	NFM15PC224D0J3	10	0.22μF±20%	6.3	2
10	NFM15PC224R1A3	10	0.22μF±20%	10	2
11	NFM15PC474D0G3	10	0.47μF±20%	4	2
12	NFM15PC474R0J3	10	0.47μF±20%	6.3	2
13	NFM15PC105R0G3	10	1μF±20%	4	2
14	NFM15PC435R0E3	10	4.3μF±20%	2.5	2

Continued on the following page.

△Note • Please read rating and △CAUTION (for storage, operating, rating, soldering, mounting and handling) in this catalog to prevent smoking and/or burning, etc.  
• This catalog has only typical specifications. Therefore, please approve our product specifications or transact the approval sheet for product specifications before ordering.

Chip Ferrite Bead

Design Kits  
Chip EMIFIL®

Chip Common Mode Choke Coil

Block Type EMIFIL®

Microwave Absorber



Continued from the preceding page.

No.	Part Number	Quantity (pcs.)	Capacitance	Rated Voltage (Vdc)	Rated Current (A)
15	NFM18PC104R1C3	10	0.1 $\mu$ F $\pm$ 20%	16	2
16	NFM18PC224R0J3	10	0.22 $\mu$ F $\pm$ 20%	6.3	2
17	NFM18PC474R0J3	10	0.47 $\mu$ F $\pm$ 20%	6.3	2
18	NFM18PC105R0J3	10	1 $\mu$ F $\pm$ 20%	6.3	4
19	NFM18PC225B0J3	10	2.2 $\mu$ F $\pm$ 20%	6.3	2
20	NFM18PC225B1A3	10	2.2 $\mu$ F $\pm$ 20%	10	4
21	NFM18PS474R0J3	10	0.47 $\mu$ F $\pm$ 20%	6.3	2
22	NFM18PS105R0J3	10	1 $\mu$ F $\pm$ 20%	6.3	2
23	NFM18PS105D0J3	10	1 $\mu$ F $\pm$ 20%	6.3	2
24	NFM21PC104R1E3	10	0.1 $\mu$ F $\pm$ 20%	25	2
25	NFM21PC224R1C3	10	0.22 $\mu$ F $\pm$ 20%	16	2
26	NFM21PC474R1C3	10	0.47 $\mu$ F $\pm$ 20%	16	2
27	NFM21PC105B1A3	10	1 $\mu$ F $\pm$ 20%	10	4
28	NFM21PC105B1C3	10	1 $\mu$ F $\pm$ 20%	16	4
29	NFM21PC225B0J3	10	2.2 $\mu$ F $\pm$ 20%	6.3	4
30	NFM21PC475B1A3	10	4.7 $\mu$ F $\pm$ 20%	10	6
31	NFM21PS106B0J3	10	10 $\mu$ F $\pm$ 20%	6.3	4
32	NFM31PC276B0J3	10	27 $\mu$ F $\pm$ 20%	6.3	6
33	NFM41PC204F1H3	10	0.2 $\mu$ F+80/-20%	50	2
34	NFM41PC155B1E3	10	1.5 $\mu$ F $\pm$ 20%	25	6
35	NFM31KC103R1H3	10	10000pF $\pm$ 20%	50	10
36	NFM31KC103R2A3	10	10000pF $\pm$ 20%	100	10
37	NFM31KC153R1H3	10	15000pF $\pm$ 20%	50	10
38	NFM31KC153R2A3	10	15000pF $\pm$ 20%	100	10
39	NFM31KC223R1H3	10	22000pF $\pm$ 20%	50	10
40	NFM31KC223R2A3	10	22000pF $\pm$ 20%	100	10
41	NFM31KC104R1H3	10	100000pF $\pm$ 20%	50	6
42	NFM31KC104R2A3	10	100000pF $\pm$ 20%	100	6
43	NFE31PT152Z1E9	10	1500pF+50/-20%	25	6
44	NFE31PT222Z1E9	10	2200pF $\pm$ 50%	25	6
45	NFE61PT102E1H9	10	1000pF+80/-20%	50	2
46	NFE61PT472C1H9	10	4700pF+80/-20%	50	2

⚠Note • Please read rating and ⚠CAUTION (for storage, operating, rating, soldering, mounting and handling) in this catalog to prevent smoking and/or burning, etc.  
 • This catalog has only typical specifications. Therefore, please approve our product specifications or transact the approval sheet for product specifications before ordering.

# Memo

# DL□/PL□

**Chip Common Mode Choke Coil**  
Large Current Common Mode Choke Coil for Automotive Available

Series Introduction .....	170
Part Numbering .....	172
Series Line Up .....	174
Product Detail .....	177
⚠Caution/Notice .....	203
Soldering and Mounting .....	205
Packaging .....	212
Design Kits .....	214

Chip Ferrite Bead

Chip EMIFIL®

Chip Common Mode Choke Coil

Block Type EMIFIL®

Microwave Absorber

⚠Note • Please read rating and ⚠CAUTION (for storage, operating, rating, soldering, mounting and handling) in this catalog to prevent smoking and/or burning, etc.  
• This catalog has only typical specifications. Therefore, please approve our product specifications or transact the approval sheet for product specifications before ordering.

# DL   Series Introduction

Common Mode Current

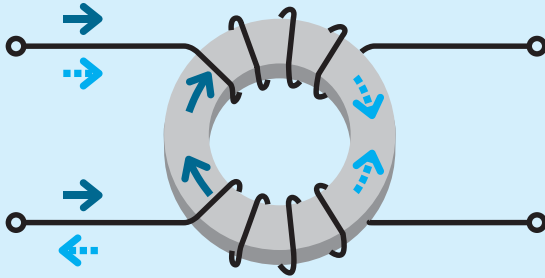

Differential Mode Current

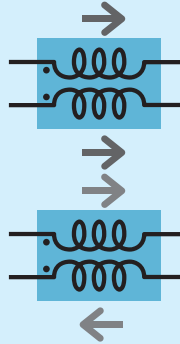

Magnetic flux caused by common mode current accumulates and works as an inductor.

Magnetic flux caused by differential mode current cancel each other and does not work as an inductor.

Category	Features, Classification	Structure	Part Number	Comments
High cut-off frequency High Coupling (For high speed differential signal lines)	Ultra high cut-off frequency for high speed differential signal lines	Film type	<ul style="list-style-type: none"> <li> DLP0QSA</li> <li> DLP0NSA</li> <li> DLP11SA</li> <li> DLP11RB</li> <li> DLP11TB</li> <li> DLP2ADA</li> </ul>	<ul style="list-style-type: none"> <li>· Low profile, small size, suitable for mobile equipment.</li> <li>· Tight terminal pitch enables high density layout.</li> <li>· Ultra high cut-off frequency and its matching to line impedance enables good transmission of high speed signal.</li> </ul>
		Wound type	<ul style="list-style-type: none"> <li> DLW21SN_HQ2</li> <li> DLW21HN_HQ2</li> </ul>	<ul style="list-style-type: none"> <li>· Ultra high self-resonance frequency enables high cut-off frequency.</li> <li>· Its matching to line impedance enables good transmission of high speed signal.</li> </ul>
	High cut-off frequency for high speed differential signal lines	Multilayer type	<ul style="list-style-type: none"> <li> DLM11SN</li> </ul>	<ul style="list-style-type: none"> <li>· Enables noise suppression for differential signal line without distortion in high-speed signal transmission.</li> </ul>
		Film type	<ul style="list-style-type: none"> <li> DLP0QSN</li> <li> DLP0NS</li> <li> DLP11SN</li> <li> DLP11RN</li> <li> DLP2AD</li> </ul>	<ul style="list-style-type: none"> <li>· Low profile, small size, suitable for mobile equipment.</li> <li>· Tight terminal pitch enables high density layout.</li> <li>· High cut-off frequency enables good transmission of high speed signal.</li> </ul>
		Wound type	<ul style="list-style-type: none"> <li> DLW21SN_SQ2</li> <li> DLW31S</li> <li> DLW21HN_SQ2</li> </ul>	<ul style="list-style-type: none"> <li>· Ultra high self-resonance frequency enables high cut-off frequency.</li> <li>· DLW21H is designed as low profile.</li> </ul>
	For general differential signal lines	Film type	<ul style="list-style-type: none"> <li> DLP31S</li> <li> DLP31D</li> </ul>	<ul style="list-style-type: none"> <li>· Low profile, small size, suitable for mobile equipment.</li> <li>· Tight terminal pitch enables high density layout.</li> </ul>
Large current High coupling (For power lines)		Wound type	<ul style="list-style-type: none"> <li> DLW5AH</li> <li> DLW5BS</li> <li> DLW5AT</li> <li> DLW5BT</li> </ul>	<ul style="list-style-type: none"> <li>· Large current (6A max.), suitable for input connector from an AC adaptor.</li> <li>· DLW5AT/DLW5BT is designed as low profile.</li> </ul>
Relative high differential mode impedance Low coupling (For audio lines)		Multilayer type	<ul style="list-style-type: none"> <li> DLM11G</li> </ul>	<ul style="list-style-type: none"> <li>· Modified differential mode impedance is higher than other common mode choke coils; this feature makes it possible to suppress both common mode and differential mode noise.</li> <li>· Ideal to keep low distortion audio signal.</li> </ul>
Large current Automotive Available (For power lines)	Available up to 18A	Winding type Cased structure	<ul style="list-style-type: none"> <li> PLT10HH</li> </ul>	<ul style="list-style-type: none"> <li>· Large current, high reliability, suitable for motors in automobiles.</li> </ul>

△Note • Please read rating and △CAUTION (for storage, operating, rating, soldering, mounting and handling) in this catalog to prevent smoking and/or burning, etc.  
• This catalog has only typical specifications. Therefore, please approve our product specifications or transact the approval sheet for product specifications before ordering.

## Skew Improvement Effect of Common Mode Choke Coil

Example of Skew Improvement by Common Mode Choke Coil  
(Tested using pulse generator waveform)

Waveform is equivalent to 1000Mbps signal

Waveform with intentionally made skew (skew: 100ps)

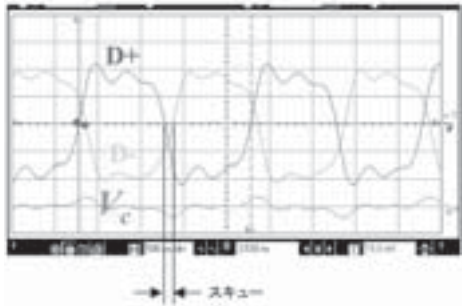

Skew is improved by common mode choke coil

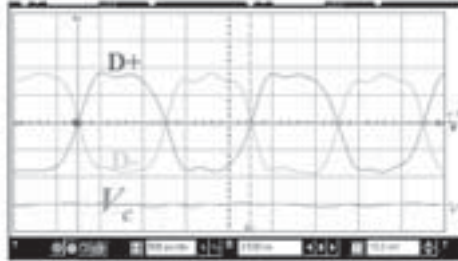

### Mechanism of Skew Improvement

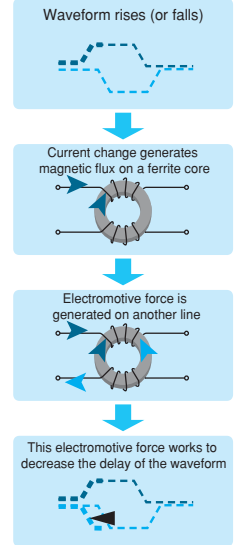

## Noise Suppression of Common Mode Choke Coil in HDMI Line

Device under test / Transmitter : game machine

/ Receiver : projector

/ Cable : HDMI category 2 3m cable

Test resolution / 1080p Deep color 12bit (Data 1.11GHz) DVD play mode

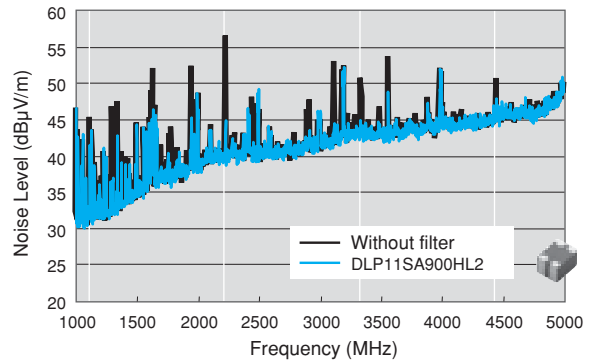
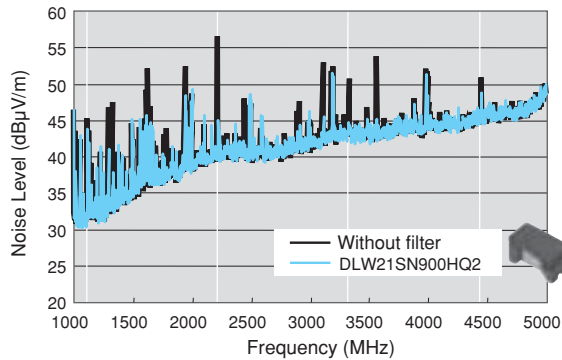

## Test Example of HDMI1.3 Waveform Transmission

~Using ESD protection device

LXES15AAA1-100 (0.05pF)~

Signal frequency : 1.11GHz (Deep color 12bit)

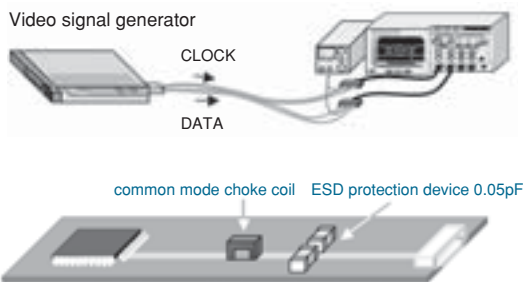

ESD protection device only

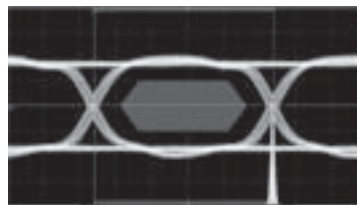

Film Type DLP11SN900HL2  
(Cut-off frequency is lowest in the table below)



	Wound Type DLW21SN900HQ2	Film Type DLP11SA900HL2	Film Type Array DLP2ADN900HL4
Cut-off Frequency	Over 10GHz	Around 6GHz	Around 4GHz
Judge	Specification satisfied	Specification satisfied	Specification satisfied
Transition Time	Rise time: 83.4ps Fall time: 77.4ps	Rise time: 90.4ps Fall time: 85.5ps	Rise time: 100ps Fall time: 97.4ps

Each common mode choke coil can keep the waveform and satisfy the specification.

△Note • Please read rating and △CAUTION (for storage, operating, rating, soldering, mounting and handling) in this catalog to prevent smoking and/or burning, etc.  
• This catalog has only typical specifications. Therefore, please approve our product specifications or transact the approval sheet for product specifications before ordering.

# DL □ Chip Common Mode Choke Coil Part Numbering

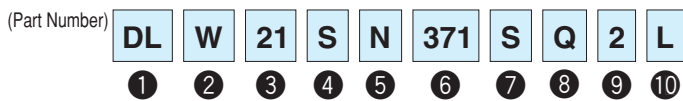

## ① Product ID

Product ID	
DL	Chip Common Mode Choke Coils

## ② Structure

Code	Structure
W	Wire Wound Type
M	Multilayer Type
P	Film Type

## ③ Dimensions (L×W)

Code	Dimensions (L×W)	EIA
0Q	0.65×0.5mm	025020
0N	0.85×0.65mm	03025
11	1.25×1.0mm	0504
1N	1.5×0.65mm	05025
21	2.0×1.2mm	0805
2A	2.0×1.0mm	0804
31	3.2×1.6mm	1206
43	4.5×3.2mm	1812
5A	5.0×3.6mm	2014
5B	5.0×5.0mm	2020

## ④ Features (1)

Code	Type
S	Magnetically Shielded One Circuit Type
D	Magnetically Shielded Two Circuit Type
H	Open Magnetic One Circuit Type
G	Magnetically Shielded Audio Type
R/T	One Circuit Low Profile Type

## ⑩ Packaging

Code	Packaging	Series
K	Embossed Taping (ø330mm Reel)	DLW5AH/DLW5BS/DLW5BT
L	Embossed Taping (ø180mm Reel)	All Series
B	Bulk	All Series
D	Paper Taping (ø180mm Reel)	DLP0QS/DLM11G

## ⑤ Category

Code	Category
A	Expressed by a letter.
B	
C	
H	
M	
N	
R	

## ⑥ Impedance

Typical impedance at 100MHz is expressed by three figures. The unit is in ohm ( $\Omega$ ). The first and second figures are significant digits, and the third figure expresses the number of zeros that follow the two figures.

## ⑥ Inductance (DLW43SH)

Expressed by three figures. The unit is micro-henry ( $\mu\text{H}$ ). The first and second figures are significant digits, and the third figure expresses the number of zeros which follow the two figures.

## ⑦ Circuit

Code	Circuit
S	Expressed by a letter.
M	
H	
U	
T	
X	

## ⑧ Features (2)

Code	Features
D	Expressed by a letter.
K	
P	
L	
Q	
Y	

## ⑨ Number of Signal Lines

Code	Number of Signal Lines
2	Two Lines
4	Four Lines

⚠Note • Please read rating and ⚠CAUTION (for storage, operating, rating, soldering, mounting and handling) in this catalog to prevent smoking and/or burning, etc.  
• This catalog has only typical specifications. Therefore, please approve our product specifications or transact the approval sheet for product specifications before ordering.

# PL    Common Mode Choke Coil Part Numbering

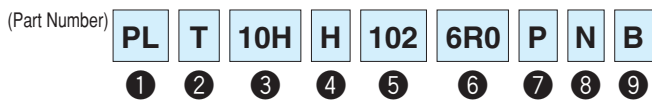

## ① Product ID

Product ID	
PL	Common Mode Choke Coils

## ② Type

Code	Type
T	DC Type

## ③ Applications

Code	Applications
10H	for DC Line High-frequency Type

## ④ Features

Code	Features
H	for Automotive

## ⑨ Packaging

Code	Packaging	Series
B	Bulk	PLT10H
L	Embossed Taping (ø178mm/ø180mm Reel)	PLT10H
K	Embossed Taping (ø330mm Reel)	PLT10H

## ⑤ Impedance

Expressed by three figures. The unit is ohm ( $\Omega$ ). The first and second figures are significant digits, and the third figure expresses the number of zeros that follow the two figures.

## ⑥ Rated Current

Expressed by three figures. The unit is ampere (A). The first and second figures are significant digits, and the third figure expresses the number of zeros that follow the two figures. A decimal point is expressed by the capital letter "R." In this case, all figures are significant digits.

## ⑦ Winding Mode

Code	Winding Mode
P	Aligned Winding Type

## ⑧ Lead Dimensions

Code	Lead Dimensions
N	No Lead Terminal (SMD)

⚠Note • Please read rating and ⚠CAUTION (for storage, operating, rating, soldering, mounting and handling) in this catalog to prevent smoking and/or burning, etc.  
• This catalog has only typical specifications. Therefore, please approve our product specifications or transact the approval sheet for product specifications before ordering.

Type	Size Code in inch (in mm)	Thickness (mm)	Part Number	Common Mode Impedance (at 100MHz/20°C)	Rated Current	New	Kit	$\geq 1A$	Hd	Z <sub>match</sub>	Flow	RefFlow
								$\geq 3A$	Uo			
Multilayer Type for Audio Lines	0504(1210) <i>p184</i>	0.5	DLM11GN601SD2	600ohm±25%	100mA							RefFlow
Multilayer Type for Differential Signal Lines	0504(1210) <i>p185</i>	0.5	DLM11SN450HY2	45ohm±25%	100mA		Kit		Hd	Z <sub>match</sub>		RefFlow
		0.5	DLM11SN900HY2	90ohm±25%	100mA		Kit		Hd	Z <sub>match</sub>		RefFlow
Chip Ferrite Bead	025020(0605) <i>p186</i>	0.3	DLP0QSN600HL2	60ohm±25%	50mA		Kit		Hd	Z <sub>match</sub>		RefFlow
		0.3	DLP0QSA070HL2	7ohm±2ohm	100mA		Kit		Uo	Z <sub>match</sub>		RefFlow
		0.3	DLP0QSA150HL2	15ohm±5ohm	100mA		Kit		Uo	Z <sub>match</sub>		RefFlow
		0.3	DLP0QSA350HL2	35ohm±10ohm	100mA		Kit		Uo	Z <sub>match</sub>		RefFlow
		0.45	DLP0NSC280HL2	28ohm±20%	100mA		Kit		Hd	Z <sub>match</sub>		RefFlow
	03025(0806) <i>p187</i>	0.45	DLP0NSN350HL2	35ohm±10ohm	100mA		Kit		Hd	Z <sub>match</sub>		RefFlow
		0.45	DLP0NSN670HL2	67ohm±20%	110mA		Kit		Hd	Z <sub>match</sub>		RefFlow
		0.45	DLP0NSN900HL2	90ohm±20%	100mA		Kit		Hd	Z <sub>match</sub>		RefFlow
		0.45	DLP0NSN121HL2	120ohm±20%	90mA		Kit		Hd	Z <sub>match</sub>		RefFlow
		0.45	DLP0NSA070HL2	7ohm±2ohm	100mA		Kit		Uo	Z <sub>match</sub>		RefFlow
Film Type for Differential Signal Lines	0504(1210) <i>p189</i>	0.82	DLP11SN670SL2	67ohm±20%	180mA		Kit		Hd			RefFlow
		0.82	DLP11SN121SL2	120ohm±20%	140mA		Kit		Hd			RefFlow
		0.82	DLP11SN161SL2	160ohm±20%	120mA		Kit		Hd			RefFlow
		0.82	DLP11SN900HL2	90ohm±20%	150mA		Kit		Hd	Z <sub>match</sub>		RefFlow
		0.82	DLP11SN201HL2	200ohm±20%	110mA		Kit		Hd	Z <sub>match</sub>		RefFlow
		0.82	DLP11SN241HL2	240ohm±20%	100mA		Kit		Hd	Z <sub>match</sub>		RefFlow
		0.82	DLP11SN281HL2	280ohm±20%	90mA		Kit		Hd	Z <sub>match</sub>		RefFlow
		0.82	DLP11SN331HL2	330ohm±20%	80mA		Kit		Hd	Z <sub>match</sub>		RefFlow
		0.82	DLP11SA350HL2	35ohm±20%	170mA		Kit		Uo	Z <sub>match</sub>		RefFlow
		0.82	DLP11SA670HL2	67ohm±20%	150mA		Kit		Uo	Z <sub>match</sub>		RefFlow
	1206(3216) <i>p190</i>	0.5	DLP11RN450UL2	45ohm±25%	100mA		Kit		Hd	Z <sub>match</sub>		RefFlow
		0.5	DLP11RB150UL2	15ohm±5ohm	100mA		Kit		Hd	Z <sub>match</sub>		RefFlow
		0.5	DLP11RB400UL2	40ohm±10ohm	100mA		Kit		Uo	Z <sub>match</sub>		RefFlow
		0.3	DLP11TB800UL2	80ohm±25%	100mA		Kit		Uo	Z <sub>match</sub>		RefFlow
		1.15	DLP31SN121ML2	120ohm±20%	100mA				Hd			RefFlow
Chip Common Mode Choke Coil	1206(3216) <i>p192</i>	1.15	DLP31SN221ML2	220ohm±20%	100mA				Hd			RefFlow
		1.15	DLP31SN551ML2	550ohm±20%	100mA				Hd			RefFlow
		0.45	DLP1NDN350HL4	35ohm±20%	100mA		Kit		Hd	Z <sub>match</sub>		RefFlow
	05025(1506) <i>p193</i>	0.45	DLP1NDN670HL4	67ohm±20%	80mA		Kit		Hd	Z <sub>match</sub>		RefFlow
		0.45	DLP1NDN900HL4	90ohm±20%	60mA		Kit		Hd	Z <sub>match</sub>		RefFlow
		0.82	DLP2ADA350HL4	35ohm±20%	150mA		Kit		Uo	Z <sub>match</sub>		RefFlow
	0804(2010) <i>p194</i>	0.82	DLP2ADA670HL4	67ohm±20%	130mA		Kit		Uo	Z <sub>match</sub>		RefFlow
		0.82	DLP2ADA900HL4	90ohm±20%	120mA		Kit		Uo	Z <sub>match</sub>		RefFlow
		0.82	DLP2ADN670HL4	67ohm±20%	140mA		Kit		Hd	Z <sub>match</sub>		RefFlow
		0.82	DLP2ADN900HL4	90ohm±20%	130mA		Kit		Hd	Z <sub>match</sub>		RefFlow
		0.82	DLP2ADN121HL4	120ohm±20%	120mA		Kit		Hd	Z <sub>match</sub>		RefFlow
		0.82	DLP2ADN161HL4	160ohm±20%	100mA		Kit		Hd	Z <sub>match</sub>		RefFlow
		0.82	DLP2ADN201HL4	200ohm±20%	90mA		Kit		Hd	Z <sub>match</sub>		RefFlow
		0.82	DLP2ADN241HL4	240ohm±20%	80mA		Kit		Hd	Z <sub>match</sub>		RefFlow
	1206(3216) <i>p196</i>	1.15	DLP31DN900ML4	90ohm±20%	160mA				Hd			RefFlow
1.15		DLP31DN131ML4	130ohm±20%	120mA				Hd			RefFlow	
1.15		DLP31DN201ML4	200ohm±20%	100mA				Hd			RefFlow	
1.15		DLP31DN321ML4	320ohm±20%	80mA				Hd			RefFlow	
1.15		DLP31DN441ML4	440ohm±20%	70mA				Hd			RefFlow	
Block Type EMIFIL®	0805(2012) <i>p197</i>	1.2	DLW21SN670SQ2	67ohm±25%	400mA		Kit		Hd			RefFlow
		1.2	DLW21SN900SQ2	90ohm±25%	330mA		Kit		Hd			RefFlow
		1.2	DLW21SN121SQ2	120ohm±25%	370mA		Kit		Hd			RefFlow
		1.2	DLW21SN181SQ2	180ohm±25%	330mA		Kit		Hd			RefFlow
		1.2	DLW21SN261SQ2	260ohm±25%	300mA		Kit		Hd			RefFlow
		1.2	DLW21SN371SQ2	370ohm±25%	280mA		Kit		Hd			RefFlow
		1.2	DLW21SN501SK2	500ohm±25%	250mA		Kit		Hd			RefFlow
		1.2	DLW21SN670HQ2	67ohm±25%	320mA		Kit		Uo	Z <sub>match</sub>		RefFlow
		1.2	DLW21SN900HQ2	90ohm±25%	280mA		Kit		Uo	Z <sub>match</sub>		RefFlow
		1.2	DLW21SN121HQ2	120ohm±25%	280mA		Kit		Uo	Z <sub>match</sub>		RefFlow
Wire Wound Type for Differential Signal Lines	0805(2012) <i>p198</i>	1.2	DLW21SN181XQ2	180ohm±25%	240mA	New	Kit		Hd			RefFlow
		1.2	DLW21SN261XQ2	260ohm±25%	220mA	New	Kit		Hd			RefFlow

Continued on the following page.

△Note • Please read rating and △CAUTION (for storage, operating, rating, soldering, mounting and handling) in this catalog to prevent smoking and/or burning, etc.  
• This catalog has only typical specifications. Therefore, please approve our product specifications or transact the approval sheet for product specifications before ordering.



Type	Size Code in inch (in mm)	Thickness (mm)	Part Number	Common Mode Impedance (at 100MHz/20°C)	Rated Current	New	Kit	$\geq 1A$	Hd	$\geq 3A$	Ud	Z <sub>match</sub>	Flow	RefFlow	
Wire Wound Type for Differential Signal Lines	0805(2012)	p198	DLW21SN491XQ2	490ohm±25%	190mA	New	Kit		Hd					RefFlow	
		p197	DLW21SR670HQ2	67ohm±25%	400mA		Kit		Ud	Z <sub>match</sub>				RefFlow	
		p199	DLW21HN670SQ2	67ohm±25%	330mA		Kit		Hd					RefFlow	
			DLW21HN900SQ2	90ohm±25%	330mA		Kit		Hd					RefFlow	
			DLW21HN121SQ2	120ohm±25%	280mA		Kit		Hd					RefFlow	
			DLW21HN181SQ2	180ohm±25%	250mA		Kit		Hd					RefFlow	
			DLW21HN670HQ2	67ohm±25%	240mA		Kit		Ud	Z <sub>match</sub>				RefFlow	
			DLW21HN900HQ2	90ohm±25%	220mA		Kit		Ud	Z <sub>match</sub>				RefFlow	
	1206(3216)	p200	DLW21HN121HQ2	120ohm±25%	200mA		Kit		Ud	Z <sub>match</sub>				RefFlow	
			DLW31SN900SQ2	90ohm±25%	370mA				Hd					RefFlow	
			DLW31SN161SQ2	160ohm±25%	340mA				Hd					RefFlow	
			DLW31SN261SQ2	260ohm±25%	310mA				Hd					RefFlow	
			DLW31SN601SQ2	600ohm±25%	260mA				Hd					RefFlow	
			DLW31SN102SQ2	1000ohm±25%	230mA				Hd					RefFlow	
	Wire Wound Type for Differential Signal Lines Automotive Type	1812(4532)	p201	DLW31SN222SQ2	2200ohm±25%	200mA				Hd					RefFlow
				DLW43SH110XK2	-	360mA									RefFlow
			DLW43SH220XK2	-	310mA									RefFlow	
			DLW43SH510XK2	-	230mA									RefFlow	
			DLW43SH101XK2	-	200mA									RefFlow	
Wire Wound Type for Power Lines and Signal Lines	2014(5036)	p177	DLW43SH101XP2	-	170mA									RefFlow	
		p177	DLW5AHN402SQ2	4000ohm (Typ.)	200mA		Kit							RefFlow	
		p179	DLW5ATN111SQ2	110ohm (Typ.)	5000mA		Kit	$\geq 3A$						RefFlow	
			DLW5ATN401SQ2	400ohm (Typ.)	2000mA		Kit	$\geq 1A$						RefFlow	
			DLW5ATN501SQ2	500ohm (Typ.)	1500mA		Kit	$\geq 1A$						RefFlow	
			DLW5ATN851SQ2	850ohm (Typ.)	1500mA		Kit	$\geq 1A$						RefFlow	
			DLW5ATN272SQ2	2700ohm (Typ.)	1000mA		Kit	$\geq 1A$						RefFlow	
		p182	DLW5ATN500MQ2	50ohm (Typ.)	6000mA		Kit	$\geq 3A$			Flow	RefFlow			
			DLW5ATN151MQ2	150ohm (Typ.)	5000mA		Kit	$\geq 3A$			Flow	RefFlow			
			DLW5ATN331MQ2	330ohm (Typ.)	4000mA		Kit	$\geq 3A$			Flow	RefFlow			
			DLW5ATN501MQ2	500ohm (Typ.)	2500mA		New	Kit	$\geq 1A$		Flow	RefFlow			
			DLW5ATN112MQ2	1100ohm (Typ.)	2000mA		Kit	$\geq 1A$			Flow	RefFlow			
		DLW5ATN111TQ2	100ohm (Typ.)	5000mA		Kit	$\geq 3A$				RefFlow				
		DLW5ATN231TQ2	230ohm (Typ.)	4000mA		Kit	$\geq 3A$				RefFlow				
		DLW5ATN401TQ2	400ohm (Typ.)	2500mA		New	Kit	$\geq 1A$			RefFlow				
		DLW5ATN501TQ2	500ohm (Typ.)	2000mA		Kit	$\geq 1A$				RefFlow				
	2020(5050)	p177	DLW5BSM501TQ2	500ohm (Typ.)	1000mA		New	Kit	$\geq 1A$					RefFlow	
			DLW5BSM601TQ2	600ohm (Typ.)	1400mA		New	Kit	$\geq 1A$					RefFlow	
			DLW5BSM801TQ2	800ohm (Typ.)	2000mA		New	Kit	$\geq 1A$					RefFlow	
			DLW5BSM191SQ2	190ohm (Typ.)	5000mA		Kit	$\geq 3A$						RefFlow	
			DLW5BSM351SQ2	350ohm (Typ.)	2000mA		Kit	$\geq 1A$						RefFlow	
			DLW5BSM102SQ2	1000ohm (Typ.)	1500mA		Kit	$\geq 1A$						RefFlow	
			DLW5BSM152SQ2	1500ohm (Typ.)	1000mA		Kit	$\geq 1A$						RefFlow	
			DLW5BSM302SQ2	3000ohm (Typ.)	500mA		Kit							RefFlow	
p179		DLW5BTM101SQ2	100ohm (Typ.)	6000mA		Kit	$\geq 3A$						RefFlow		
		DLW5BTM251SQ2	250ohm (Typ.)	5000mA		Kit	$\geq 3A$						RefFlow		
		DLW5BTM501SQ2	500ohm (Typ.)	4000mA		Kit	$\geq 3A$						RefFlow		
p182			DLW5BTM102SQ2	1000ohm (Typ.)	2000mA		Kit	$\geq 1A$						RefFlow	
		DLW5BTM142SQ2	1400ohm (Typ.)	1500mA		Kit	$\geq 1A$						RefFlow		
		DLW5BTM101TQ2	100ohm (Typ.)	6000mA		Kit	$\geq 3A$						RefFlow		
		DLW5BTM251TQ2	250ohm (Typ.)	5000mA		Kit	$\geq 3A$						RefFlow		
		DLW5BTM501TQ2	500ohm (Typ.)	4000mA		Kit	$\geq 3A$						RefFlow		
		DLW5BTM102TQ2	1000ohm (Typ.)	2500mA		New	Kit	$\geq 1A$					RefFlow		
	DLW5BTM142TQ2	1400ohm (Typ.)	2000mA		Kit	$\geq 1A$						RefFlow			

△Note • Please read rating and △CAUTION (for storage, operating, rating, soldering, mounting and handling) in this catalog to prevent smoking and/or burning, etc.  
 • This catalog has only typical specifications. Therefore, please approve our product specifications or transact the approval sheet for product specifications before ordering.

Chip Ferrite Bead

Chip EMIFIL®

Chip Common Mode Choke Coil

Block Type EMIFIL®

Microwave Absorber

# PL

## Large Current Common Mode Choke Coil for Automotive Available

### Series Line Up

Type	Size in inch (in mm)	Thickness (mm)	Part Number	Common Mode Impedance (at 10MHz/20°C)	Rated Current	New	Kit	≥3A	Hd	U <sub>D</sub>	Z <sub>match</sub>	F <sub>low</sub>	R <sub>eFlow</sub>
Large Current Common Mode Choke Coil for Automotive Available	p202  (12.9x6.6)	9.4	<b>PLT10HH450180PN</b>	45ohm (Typ.)	18A		Kit	≥10A					R <sub>eFlow</sub>
		9.4	<b>PLT10HH101150PN</b>	100ohm (Typ.)	15A		Kit	≥10A					R <sub>eFlow</sub>
		9.4	<b>PLT10HH401100PN</b>	400ohm (Typ.)	10A		Kit	≥10A					R <sub>eFlow</sub>
		9.4	<b>PLT10HH501100PN</b>	500ohm (Typ.)	10A		Kit	≥10A					R <sub>eFlow</sub>
		9.4	<b>PLT10HH9016R0PN</b>	900ohm (Typ.)	6A		Kit	≥3A					R <sub>eFlow</sub>
		9.4	<b>PLT10HH1026R0PN</b>	1000ohm (Typ.)	6A		Kit	≥3A					R <sub>eFlow</sub>

Chip Ferrite Bead

Chip EMIFIL®

Chip Common Mode Choke Coil

Block Type EMIFIL®

Microwave Absorber

⚠Note • Please read rating and ⚠CAUTION (for storage, operating, rating, soldering, mounting and handling) in this catalog to prevent smoking and/or burning, etc.  
• This catalog has only typical specifications. Therefore, please approve our product specifications or transact the approval sheet for product specifications before ordering.

# DLW5AH/DLW5BS Series

2014/5036 (inch/mm)  
2020/5050 (inch/mm)



5A max., common mode choke coil for power lines.

**DLW5AH**



**■ Dimensions**

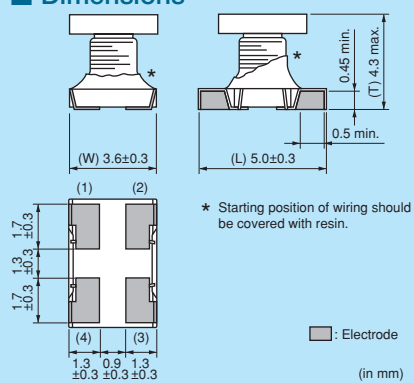

\* Starting position of wiring should be covered with resin.

□ : Electrode  
(in mm)

**■ Equivalent Circuit**

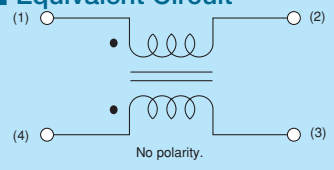

No polarity.

**■ Packaging**

Code	Packaging	Minimum Quantity
L	180mm Reel Embossed Tape	400
K	330mm Reel Embossed Tape	1500
B	Bulk(Bag)	100

**DLW5BS**



**■ Dimensions**

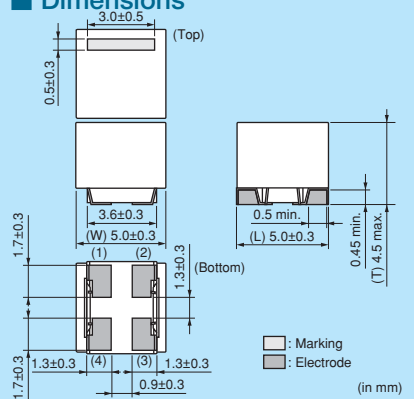

□ : Marking  
□ : Electrode  
(in mm)

**■ Equivalent Circuit**

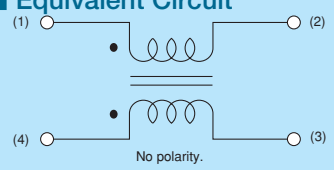

No polarity.

**■ Packaging**

Code	Packaging	Minimum Quantity
L	180mm Reel Embossed Tape	400
K	330mm Reel Embossed Tape	1500
B	Bulk(Bag)	100

Refer to pages from p.205 to p.209 for mounting information.

**■ Rated Value** (□: packaging code)

Part Number	Common Mode Impedance (at 10MHz/20°C)	Common Mode Impedance (at 100MHz/20°C)	Rated Current	Rated Voltage	Insulation Resistance (min.)	Withstand Voltage	DC Resistance	
DLW5AHN402SQ2□	-	4000ohm (Typ.)	200mA	50Vdc	10M ohm	125Vdc	3.0ohm max.	Kit
DLW5BSM501TQ2□	2800ohm ±40%	500ohm (Typ.)	1000mA	50Vdc	10M ohm	125Vdc	0.23ohm max.	New Kit ≥1A
DLW5BSM601TQ2□	1200ohm ±40%	600ohm (Typ.)	1400mA	50Vdc	10M ohm	125Vdc	0.12ohm max.	New Kit ≥1A
DLW5BSM801TQ2□	550ohm ±40%	800ohm (Typ.)	2000mA	50Vdc	10M ohm	125Vdc	0.056ohm max.	New Kit ≥1A
DLW5BSM191SQ2□	-	190ohm (Typ.)	5000mA	50Vdc	10M ohm	125Vdc	0.02ohm max.	Kit ≥3A
DLW5BSM351SQ2□	-	350ohm (Typ.)	2000mA	50Vdc	10M ohm	125Vdc	0.04ohm max.	Kit ≥1A
DLW5BSM102SQ2□	-	1000ohm (Typ.)	1500mA	50Vdc	10M ohm	125Vdc	0.06ohm max.	Kit ≥1A
DLW5BSM152SQ2□	-	1500ohm (Typ.)	1000mA	50Vdc	10M ohm	125Vdc	0.1ohm max.	Kit ≥1A
DLW5BSM302SQ2□	-	3000ohm (Typ.)	500mA	50Vdc	10M ohm	125Vdc	0.3ohm max.	Kit

Operating Temperature Range: -25°C to +85°C (DLW5AH), -40°C to +105°C (DLW5BS\_TQ2), -40°C to +85°C (DLW5BS\_SQ2) Number of Circuit: 1

Continued on the following page.

△Note • Please read rating and △CAUTION (for storage, operating, rating, soldering, mounting and handling) in this catalog to prevent smoking and/or burning, etc.  
• This catalog has only typical specifications. Therefore, please approve our product specifications or transact the approval sheet for product specifications before ordering.

**Impedance-Frequency Characteristics**  
**DLW5AH\_SQ2/DLW5BS\_SQ2 Series**

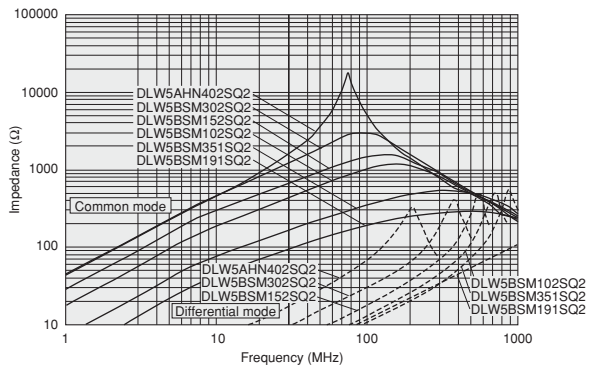

**DLW5BS\_TQ2 Series**

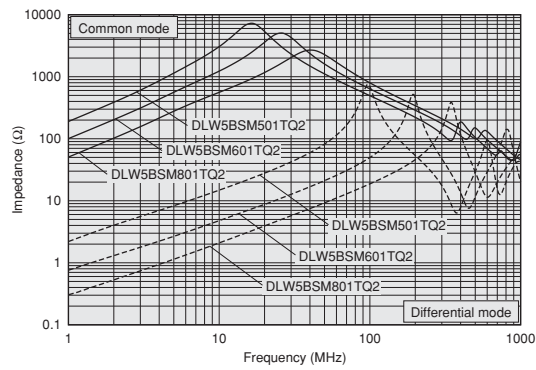

**Notice (Rating)**

In operating temperature exceeding +75°C, derating of current is necessary for DLW5BSM191SQ2. Please apply the derating curve shown in chart according to the operating temperature.

Derating of Rated Current

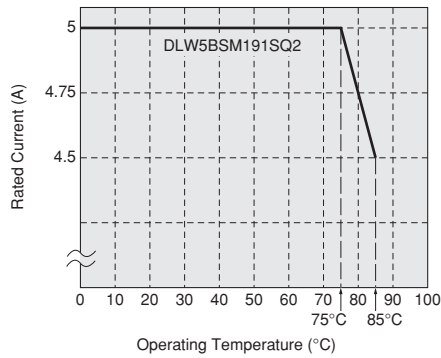

In operating temperature exceeding +65°C, derating of current is necessary for DLW5BS\_TQ2 series. Please apply the derating curve shown in chart according to the operating temperature.

Derating of Rated Current

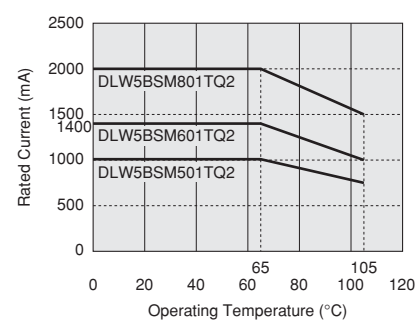

⚠Note • Please read rating and ⚠CAUTION (for storage, operating, rating, soldering, mounting and handling) in this catalog to prevent smoking and/or burning, etc.  
 • This catalog has only typical specifications. Therefore, please approve our product specifications or transact the approval sheet for product specifications before ordering.

Chip Ferrite Bead

Chip EMIFIL®

Chip Common Mode Choke Coil  
 Universal Type [Power Lines/Signal Lines]

Block Type EMIFIL®

Microwave Absorber

# DLW5AT/DLW5BT Series 2014/5036 (inch/mm) Hi Power 2020/5050 (inch/mm) Reflow OK

Low profile wire-wound common choke coil for power lines.



**DLW5AT**

**■ Dimensions**

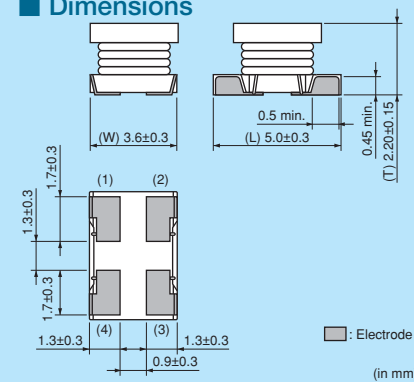

Legend:  Electrode (in mm)

**■ Equivalent Circuit**

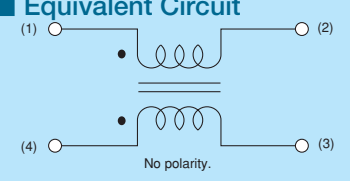

No polarity.

**■ Packaging**

Code	Packaging	Minimum Quantity
L	180mm Reel Embossed Tape	700
K	330mm Reel Embossed Tape	2500
B	Bulk(Bag)	100



**DLW5BT**

**■ Dimensions**

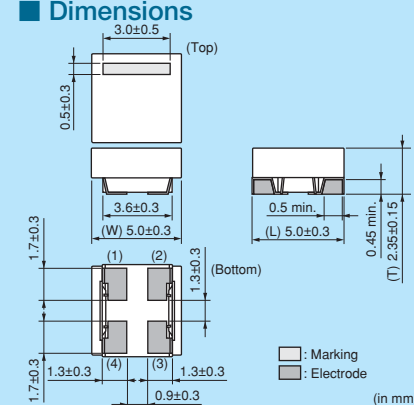

Legend:  Marking  Electrode (in mm)

**■ Equivalent Circuit**

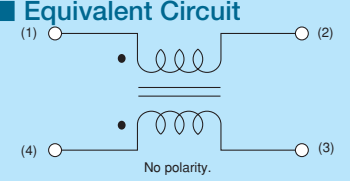

No polarity.

**■ Packaging**

Code	Packaging	Minimum Quantity
L	180mm Reel Embossed Tape	700
K	330mm Reel Embossed Tape	2500
B	Bulk(Bag)	100

Refer to pages from p.205 to p.209 for mounting information.

**■ Rated Value** (□: packaging code)

Part Number	Common Mode Impedance (at 100MHz/20°C)	Rated Current	Rated Voltage	Insulation Resistance (min.)	Withstand Voltage	DC Resistance	
DLW5ATN111SQ2□	110ohm (Typ.)	5000mA	50Vdc	10M ohm	125Vdc	0.020ohm max.	Kit ≥3A
DLW5ATN401SQ2□	400ohm (Typ.)	2000mA	50Vdc	10M ohm	125Vdc	0.034ohm max.	Kit ≥1A
DLW5ATN501SQ2□	500ohm (Typ.)	1500mA	50Vdc	10M ohm	125Vdc	0.056ohm max.	Kit ≥1A
DLW5ATN851SQ2□	850ohm (Typ.)	1500mA	50Vdc	10M ohm	125Vdc	0.073ohm max.	Kit ≥1A
DLW5ATN272SQ2□	2700ohm (Typ.)	1000mA	50Vdc	10M ohm	125Vdc	0.12ohm max.	Kit ≥1A
DLW5BTM101SQ2□	100ohm (Typ.)	6000mA	50Vdc	10M ohm	125Vdc	0.013ohm max.	Kit ≥3A
DLW5BTM251SQ2□	250ohm (Typ.)	5000mA	50Vdc	10M ohm	125Vdc	0.020ohm max.	Kit ≥3A
DLW5BTM501SQ2□	500ohm (Typ.)	4000mA	50Vdc	10M ohm	125Vdc	0.027ohm max.	Kit ≥3A
DLW5BTM102SQ2□	1000ohm (Typ.)	2000mA	50Vdc	10M ohm	125Vdc	0.034ohm max.	Kit ≥1A
DLW5BTM142SQ2□	1400ohm (Typ.)	1500mA	50Vdc	10M ohm	125Vdc	0.056ohm max.	Kit ≥1A

Operating Temperature Range: -40°C to +85°C Number of Circuit: 1

Continued on the following page.

△Note • Please read rating and △CAUTION (for storage, operating, rating, soldering, mounting and handling) in this catalog to prevent smoking and/or burning, etc.  
 • This catalog has only typical specifications. Therefore, please approve our product specifications or transact the approval sheet for product specifications before ordering.

**Impedance-Frequency Characteristics**  
**DLW5AT Series**

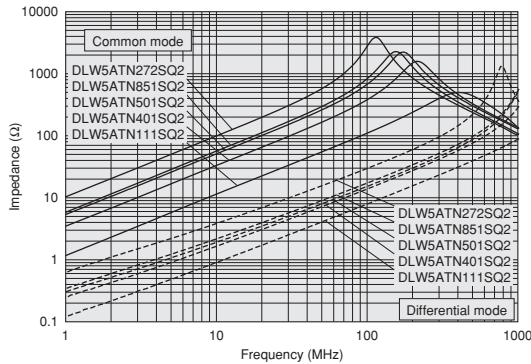

**DLW5BT Series**

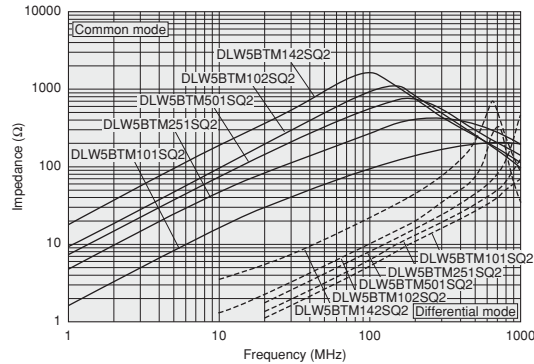

**Notice (Rating)**

In operating temperature exceeding +60°C, derating of current is necessary for DLW5AT series. Please apply the derating curve shown in chart according to the operating temperature.

In operating temperature exceeding +60°C, derating of current is necessary for the following part name of DLW5BT series. Please apply the derating curve shown in chart according to the operating temperature.

Derating of Rated Current

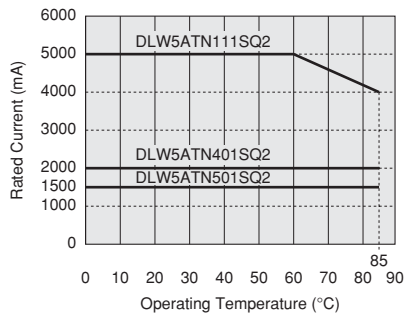

Derating of Rated Current

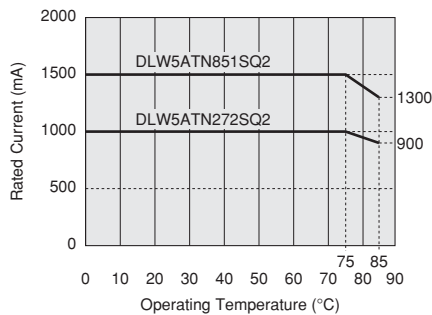
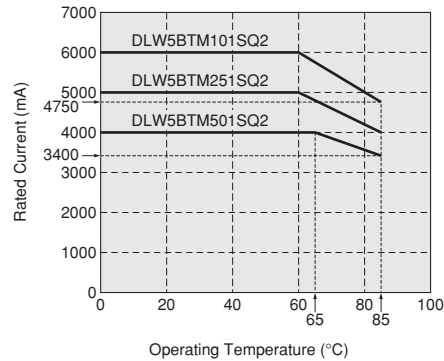

△Note • Please read rating and △CAUTION (for storage, operating, rating, soldering, mounting and handling) in this catalog to prevent smoking and/or burning, etc.  
 • This catalog has only typical specifications. Therefore, please approve our product specifications or transact the approval sheet for product specifications before ordering.

Chip Ferrite Bead  
 Chip EMIFIL®  
 Chip Common Mode Choke Coil  
 Universal Type [Power Lines/Signal Lines]  
 Block Type EMIFIL®  
 Microwave Absorber

# DLW5AT/DLW5BT Series (105degreeC available type)



Low profile wire-wound common choke coil for power lines. (105degreeC available type)

DLW5AT\_MQ2



**■ Dimensions**

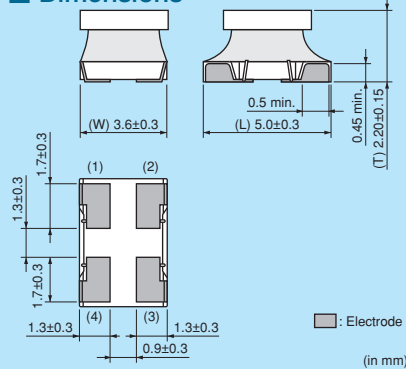

**■ Equivalent Circuit**

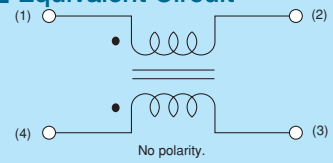

**■ Packaging**

Code	Packaging	Minimum Quantity
L	180mm Reel Embossed Tape	700
K	330mm Reel Embossed Tape	2500
B	Bulk(Bag)	100

DLW5AT\_TQ2



**■ Dimensions**

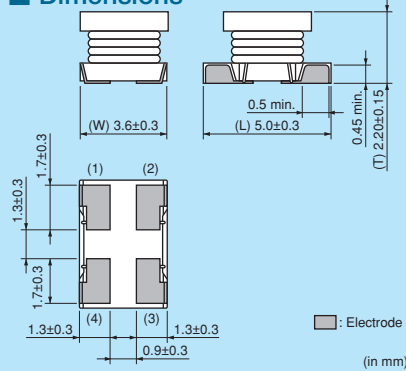

**■ Equivalent Circuit**

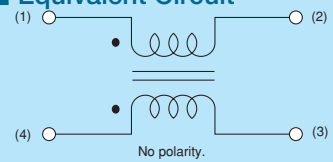

**■ Packaging**

Code	Packaging	Minimum Quantity
L	180mm Reel Embossed Tape	700
K	330mm Reel Embossed Tape	2500
B	Bulk(Bag)	100

DLW5BT\_TQ2



**■ Dimensions**

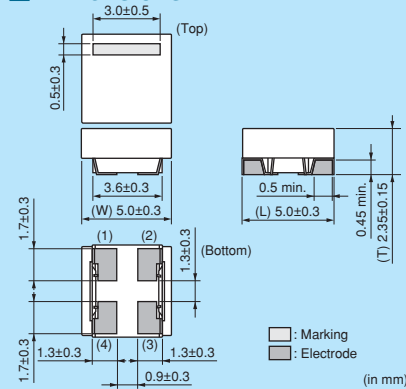

**■ Equivalent Circuit**

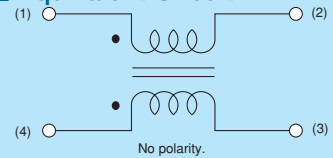

**■ Packaging**

Code	Packaging	Minimum Quantity
L	180mm Reel Embossed Tape	700
K	330mm Reel Embossed Tape	2500
B	Bulk(Bag)	100

Refer to pages from p.205 to p.209 for mounting information.

Continued on the following page.

**△Note** • Please read rating and **△CAUTION** (for storage, operating, rating, soldering, mounting and handling) in this catalog to prevent smoking and/or burning, etc.  
 • This catalog has only typical specifications. Therefore, please approve our product specifications or transact the approval sheet for product specifications before ordering.

Rated Value (□: packaging code)

Part Number	Common Mode Impedance (at 100MHz/20°C)	Rated Current	Rated Voltage	Insulation Resistance (min.)	Withstand Voltage	DC Resistance				
DLW5ATN500MQ2□	50ohm (Typ.)	6000mA	50Vdc	10M ohm	125Vdc	0.013ohm max.	Kit	≥3A	Flow	ReFlow
DLW5ATN151MQ2□	150ohm (Typ.)	5000mA	50Vdc	10M ohm	125Vdc	0.020ohm max.	Kit	≥3A	Flow	ReFlow
DLW5ATN331MQ2□	330ohm (Typ.)	4000mA	50Vdc	10M ohm	125Vdc	0.027ohm max.	Kit	≥3A	Flow	ReFlow
DLW5ATN501MQ2□	500ohm (Typ.)	2500mA	50Vdc	10M ohm	125Vdc	0.034ohm max.	New Kit	≥1A	Flow	ReFlow
DLW5ATN112MQ2□	1100ohm (Typ.)	2000mA	50Vdc	10M ohm	125Vdc	0.056ohm max.	Kit	≥1A	Flow	ReFlow
DLW5ATN111TQ2□	110ohm (Typ.)	5000mA	50Vdc	10M ohm	125Vdc	0.020ohm max.	Kit	≥3A		ReFlow
DLW5ATN231TQ2□	230ohm (Typ.)	4000mA	50Vdc	10M ohm	125Vdc	0.027ohm max.	Kit	≥3A		ReFlow
DLW5ATN401TQ2□	400ohm (Typ.)	2500mA	50Vdc	10M ohm	125Vdc	0.034ohm max.	New Kit	≥1A		ReFlow
DLW5ATN501TQ2□	500ohm (Typ.)	2000mA	50Vdc	10M ohm	125Vdc	0.056ohm max.	Kit	≥1A		ReFlow
DLW5BTM101TQ2□	100ohm (Typ.)	6000mA	50Vdc	10M ohm	125Vdc	0.013ohm max.	Kit	≥3A		ReFlow
DLW5BTM251TQ2□	250ohm (Typ.)	5000mA	50Vdc	10M ohm	125Vdc	0.020ohm max.	Kit	≥3A		ReFlow
DLW5BTM501TQ2□	500ohm (Typ.)	4000mA	50Vdc	10M ohm	125Vdc	0.027ohm max.	Kit	≥3A		ReFlow
DLW5BTM102TQ2□	1000ohm (Typ.)	2500mA	50Vdc	10M ohm	125Vdc	0.034ohm max.	New Kit	≥1A		ReFlow
DLW5BTM142TQ2□	1400ohm (Typ.)	2000mA	50Vdc	10M ohm	125Vdc	0.056ohm max.	Kit	≥1A		ReFlow

Operating Temperature Range: -40°C to +105°C Number of Circuit: 1

Impedance-Frequency Characteristics  
DLW5AT\_MQ2 Series

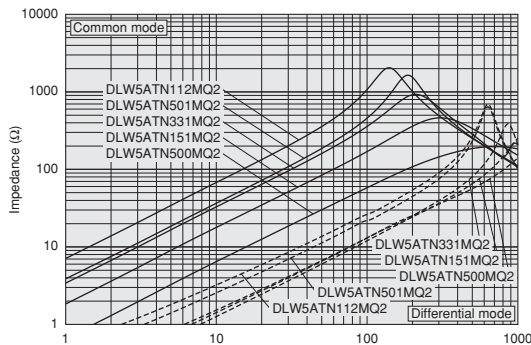

DLW5AT\_TQ2 Series

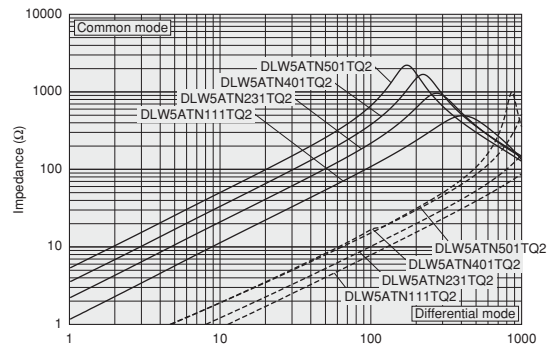

DLW5BT\_TQ2 Series

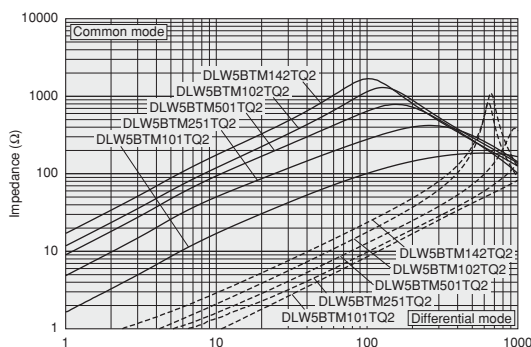

△Note • Please read rating and △CAUTION (for storage, operating, rating, soldering, mounting and handling) in this catalog to prevent smoking and/or burning, etc.  
• This catalog has only typical specifications. Therefore, please approve our product specifications or transact the approval sheet for product specifications before ordering.

Chip Ferrite Bead

Chip EMIFIL®

Chip Common Mode Choke Coil  
Universal Type [Power Lines/Signal Lines]

Block Type EMIFIL®

Microwave Absorber



**Notice (Rating)**

In operating temperature exceeding +85°C, derating of current is necessary for DLW5AT series (105 degree C available type). Please apply the derating curve shown in chart according to the operating temperature.

In operating temperature exceeding +85°C, derating of current is necessary for DLW5AT series (105 degree C available type). Please apply the derating curve shown in chart according to the operating temperature.

Derating of Rated Current

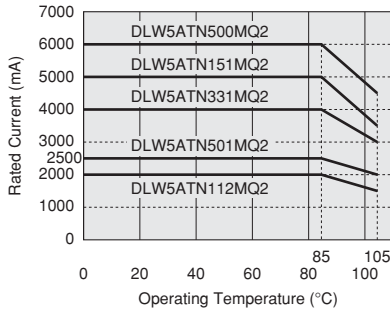

Derating of Rated Current

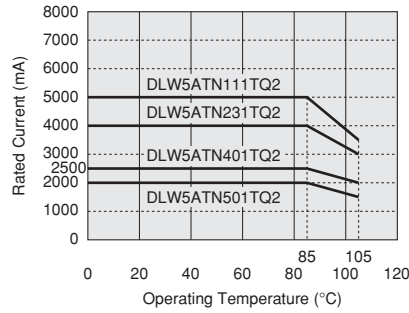

In operating temperature exceeding +85°C, derating of current is necessary for DLW5BT series (105 degree C available type). Please apply the derating curve shown in chart according to the operating temperature.

Derating of Rated Current

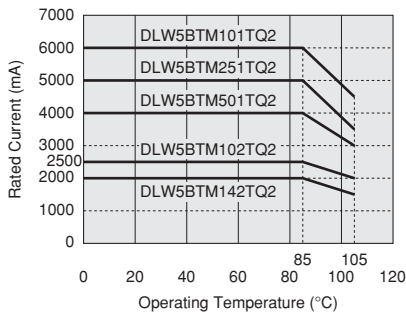

⚠Note • Please read rating and ⚠CAUTION (for storage, operating, rating, soldering, mounting and handling) in this catalog to prevent smoking and/or burning, etc.  
• This catalog has only typical specifications. Therefore, please approve our product specifications or transact the approval sheet for product specifications before ordering.

# DLM11G Series 0504/1210 (inch/mm)



Audio line common choke also effective to differential mode.

### ■ Dimensions

(in mm)

### ■ Equivalent Circuit

No polarity.

### ■ Packaging

Code	Packaging	Minimum Quantity
D	180mm Reel Paper Tape	10000
B	Bulk(Bag)	1000

Refer to pages from p.205 to p.209 for mounting information.

### ■ Rated Value (□: packaging code)

Part Number	Common Mode Impedance (at 100MHz/20°C)	Rated Current	Rated Voltage	Insulation Resistance (min.)	Withstand Voltage	DC Resistance	Operating Temperature Range
DLM11GN601SD2□	600ohm ±25%	100mA	5Vdc	100M ohm	25Vdc	0.8ohm max.	-40°C to +85°C

Number of Circuit: 1

### ■ Impedance-Frequency Characteristics

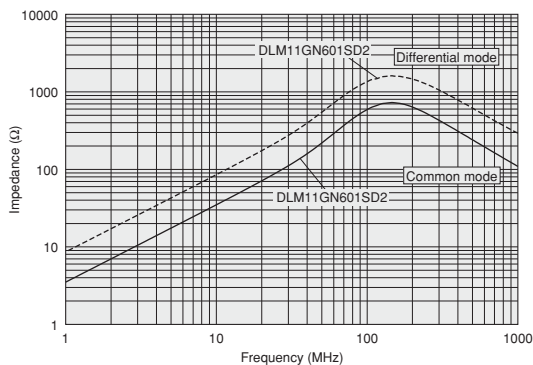

△Note • Please read rating and △CAUTION (for storage, operating, rating, soldering, mounting and handling) in this catalog to prevent smoking and/or burning, etc.  
 • This catalog has only typical specifications. Therefore, please approve our product specifications or transact the approval sheet for product specifications before ordering.

Chip Ferrite Bead

Chip EMIFIL®

Chip Common Mode Choke Coil  
Signal Lines Type

Block Type EMIFIL®

Microwave Absorber

# DLM11S Series 0504/1210 (inch/mm)



## 0504 size multilayer type chip common mode choke coil.



### ■ Dimensions

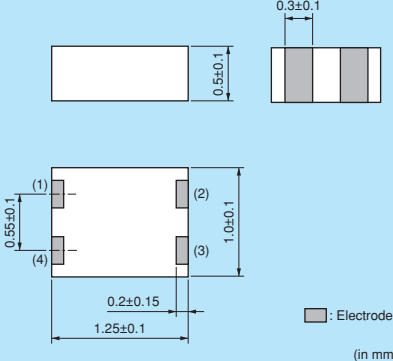

(in mm)

### ■ Equivalent Circuit

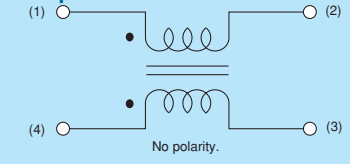

No polarity.

### ■ Packaging

Code	Packaging	Minimum Quantity
L	180mm Reel Embossed Tape	4000
B	Bulk(Bag)	500

Refer to pages from p.205 to p.209 for mounting information.

### ■ Rated Value (□: packaging code)

Part Number	Common Mode Impedance (at 100MHz/20°C)	Rated Current	Rated Voltage	Insulation Resistance (min.)	Withstand Voltage	DC Resistance	
DLM11SN450HY2□	45ohm ±25%	100mA	5Vdc	100M ohm	12.5Vdc	0.7ohm±25%	Kit HD
DLM11SN900HY2□	90ohm ±25%	100mA	5Vdc	100M ohm	12.5Vdc	1.1ohm±25%	Kit HD

Operating Temperature Range: -40°C to +85°C Number of Circuit: 1

### ■ Impedance-Frequency Characteristics

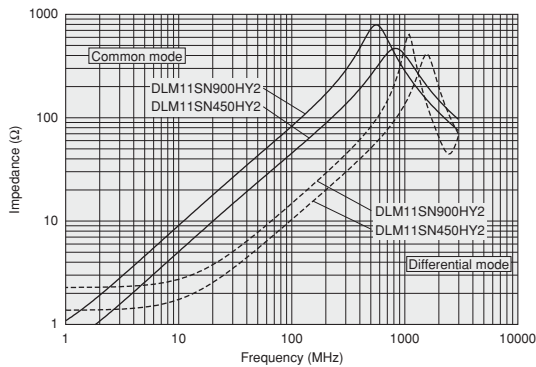

### ■ Differential Mode Transmission Characteristics (Typ.)

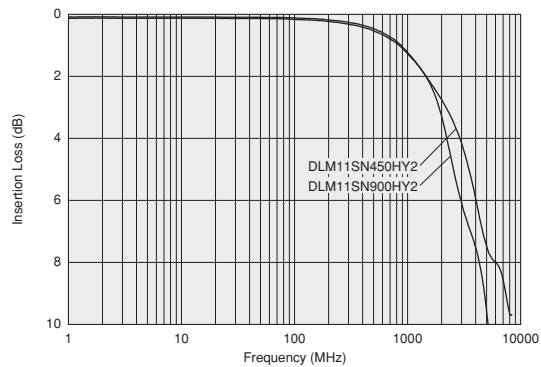

⚠Note • Please read rating and ⚠CAUTION (for storage, operating, rating, soldering, mounting and handling) in this catalog to prevent smoking and/or burning, etc.  
 • This catalog has only typical specifications. Therefore, please approve our product specifications or transact the approval sheet for product specifications before ordering.

# DLPOQS Series 025020/0605 (inch/mm)



025020 size, very small chip common mode choke coil, Cut-off frequency 8GHz max. Some of them are ready for Display port or SATA.

### ■ Dimensions

(in mm)

### ■ Equivalent Circuit

No polarity.

### ■ Packaging

Code	Packaging	Minimum Quantity
D	180mm Reel Paper Tape	15000
B	Bulk(Bag)	500

Refer to pages from p.205 to p.209 for mounting information.

### ■ Rated Value (□: packaging code)

Part Number	Common Mode Impedance (at 100MHz/20°C)	Rated Current	Rated Voltage	Insulation Resistance (min.)	Withstand Voltage	DC Resistance	
DLPOQSN600HL2□	60ohm ±25%	50mA	5Vdc	100M ohm	12.5Vdc	3.8ohm±25%	Kit
DLPOQSA070HL2□	7ohm ±2ohm	100mA	5Vdc	100M ohm	12.5Vdc	0.7ohm±25%	Kit
DLPOQSA150HL2□	15ohm ±5ohm	100mA	5Vdc	100M ohm	12.5Vdc	0.8ohm±25%	Kit
DLPOQSA350HL2□	35ohm ±10ohm	100mA	5Vdc	100M ohm	12.5Vdc	2.2ohm±25%	Kit

Operating Temperature Range: -40°C to +85°C Number of Circuit: 1

HD: for high speed differential signal lines UD: for ultra high speed differential signal lines

### ■ Impedance-Frequency Characteristics DLPOQSN Series

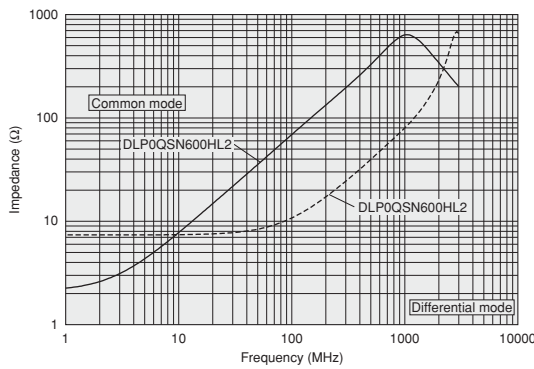

### DLPOQSA Series

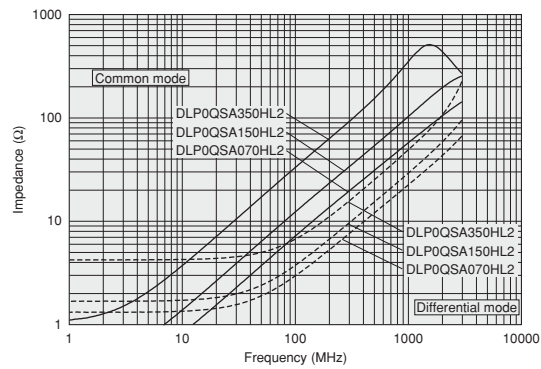

### ■ Differential Mode Transmission Characteristics (Typ.) DLPOQSN Series

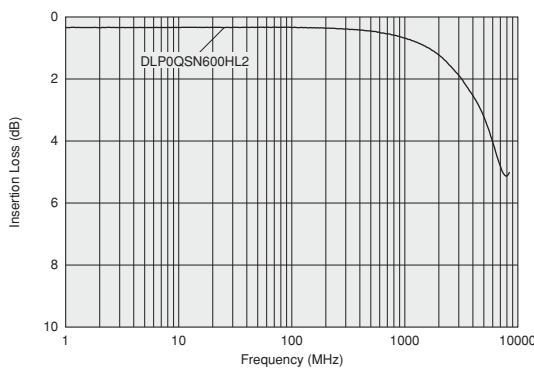

### DLPOQSA Series

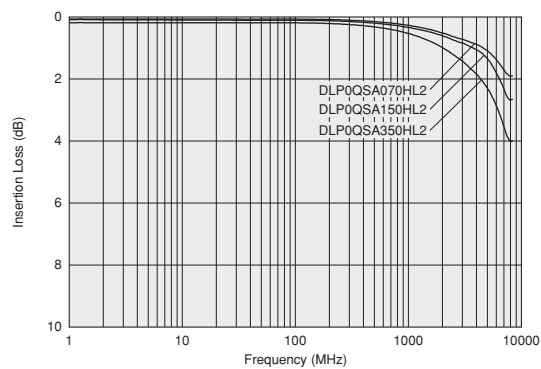

△Note • Please read rating and △CAUTION (for storage, operating, rating, soldering, mounting and handling) in this catalog to prevent smoking and/or burning, etc.  
• This catalog has only typical specifications. Therefore, please approve our product specifications or transact the approval sheet for product specifications before ordering.

Chip Ferrite Bead

Chip EMIFIL®

Chip Common Mode Choke Coil  
Signal Lines Type

Block Type EMIFIL®

Microwave Absorber

# DLP0NS Series 03025/0806 (inch/mm)



03025 size, very small chip common mode choke coil, Cut-off frequency 8GHz max. Some of them are ready for mipi, Display port or SATA.

### ■ Dimensions

(in mm)

### ■ Equivalent Circuit

No polarity.

### ■ Packaging

Code	Packaging	Minimum Quantity
L	180mm Reel Embossed Tape	10000
B	Bulk (Bag)	500

Refer to pages from p.205 to p.209 for mounting information.

### ■ Rated Value (□: packaging code)

Part Number	Common Mode Impedance (at 100MHz/20°C)	Rated Current	Rated Voltage	Insulation Resistance (min.)	Withstand Voltage	DC Resistance	
DLP0NSC280HL2□	28ohm ±20%	100mA	5Vdc	100M ohm	12.5Vdc	1.3ohm±25%	Kit HD
DLP0NSN350HL2□	35ohm ±10ohm	100mA	5Vdc	100M ohm	12.5Vdc	1.2ohm±25%	Kit HD
DLP0NSN670HL2□	67ohm ±20%	110mA	5Vdc	100M ohm	12.5Vdc	2.4ohm±25%	Kit HD
DLP0NSN900HL2□	90ohm ±20%	100mA	5Vdc	100M ohm	12.5Vdc	3.0ohm±25%	Kit HD
DLP0NSN121HL2□	120ohm ±20%	90mA	5Vdc	100M ohm	12.5Vdc	3.8ohm±25%	Kit HD
DLP0NSA070HL2□	7ohm ±2ohm	100mA	5Vdc	100M ohm	12.5Vdc	0.6ohm±25%	Kit
DLP0NSA150HL2□	15ohm ±5ohm	100mA	5Vdc	100M ohm	12.5Vdc	0.95ohm±25%	Kit

Operating Temperature Range: -40°C to +85°C Number of Circuit: 1

HD: for high speed differential signal lines

UD: for ultra high speed differential signal lines

### ■ Impedance-Frequency Characteristics

#### DLP0NSC/DLP0NSN Series

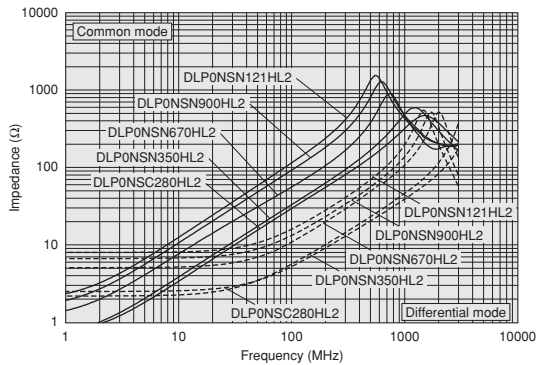

#### DLP0NSA Series

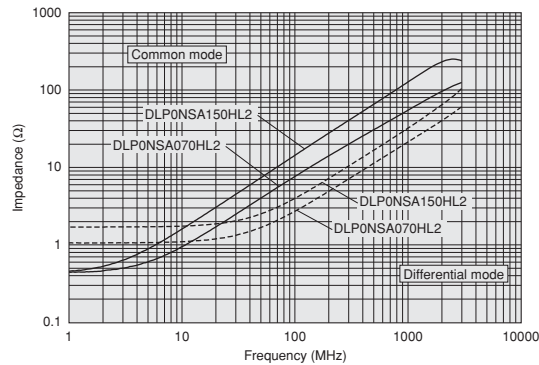

Continued on the following page.

⚠Note • Please read rating and ⚠CAUTION (for storage, operating, rating, soldering, mounting and handling) in this catalog to prevent smoking and/or burning, etc.  
• This catalog has only typical specifications. Therefore, please approve our product specifications or transact the approval sheet for product specifications before ordering.

■ Differential Mode Transmission Characteristics (Typ.)

DLP0NSC/DLP0NSN Series

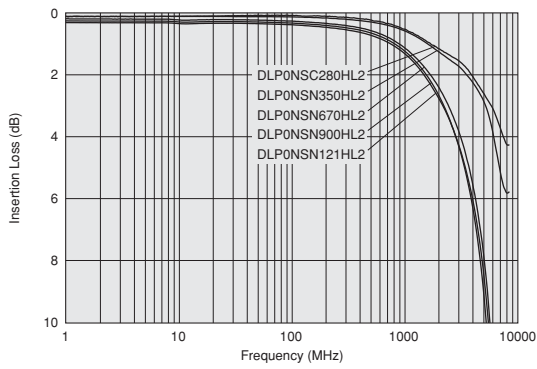

DLP0NSA Series

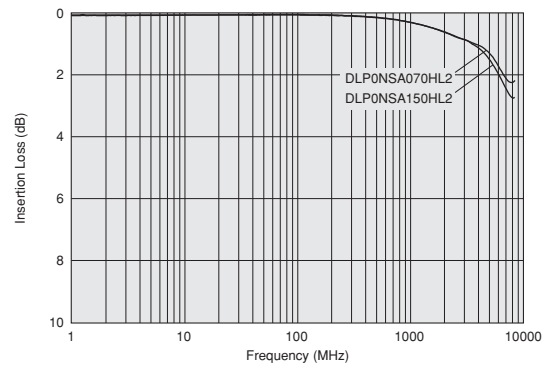

Chip Ferrite Bead

Chip EMIFIL®

Chip Common Mode Choke Coil  
 Signal Lines Type

Block Type EMIFIL®

Microwave Absorber

△Note • Please read rating and △CAUTION (for storage, operating, rating, soldering, mounting and handling) in this catalog to prevent smoking and/or burning, etc.  
 • This catalog has only typical specifications. Therefore, please approve our product specifications or transact the approval sheet for product specifications before ordering.

# DLP11S/DLP11R/DLP11T Series 0504/1210 (inch/mm)



8GHz cut-off frequency (for HDMI/USB3.0) is available.

### ■ Dimensions

Part Number	T
DLP11S	0.82±0.1
DLP11R	0.5±0.1
DLP11T	0.3±0.05

Legend:  Electrode (in mm)

### ■ Equivalent Circuit

### ■ Packaging

Code	Packaging	Minimum Quantity
L	180mm Reel Embossed Tape	3000 (DLP11S)
		4000 (DLP11RN/RB)
		5000 (DLP11T)
B	Bulk(Bag)	500

Refer to pages from p.205 to p.209 for mounting information.

## ■ Rated Value (□: packaging code)

Part Number	Common Mode Impedance (at 100MHz/20°C)	Rated Current	Rated Voltage	Insulation Resistance (min.)	Withstand Voltage	DC Resistance	Kit	HD	UD	Imp. Match
DLP11SN670SL2□	67ohm ±20%	180mA	5Vdc	100M ohm	12.5Vdc	1.3ohm±25%	Kit	HD		
DLP11SN121SL2□	120ohm ±20%	140mA	5Vdc	100M ohm	12.5Vdc	2.0ohm±25%	Kit	HD		
DLP11SN161SL2□	160ohm ±20%	120mA	5Vdc	100M ohm	12.5Vdc	2.7ohm±25%	Kit	HD		
DLP11SN900HL2□	90ohm ±20%	150mA	5Vdc	100M ohm	12.5Vdc	1.5ohm±25%	Kit	HD		Imp. Match
DLP11SN201HL2□	200ohm ±20%	110mA	5Vdc	100M ohm	12.5Vdc	3.1ohm±25%	Kit	HD		Imp. Match
DLP11SN241HL2□	240ohm ±20%	100mA	5Vdc	100M ohm	12.5Vdc	3.5ohm±25%	Kit	HD		Imp. Match
DLP11SN281HL2□	280ohm ±20%	90mA	5Vdc	100M ohm	12.5Vdc	4.2ohm±25%	Kit	HD		Imp. Match
DLP11SN331HL2□	330ohm ±20%	80mA	5Vdc	100M ohm	12.5Vdc	4.9ohm±25%	Kit	HD		Imp. Match
DLP11SA350HL2□	35ohm ±20%	170mA	5Vdc	100M ohm	12.5Vdc	0.9ohm±25%	Kit		UD	Imp. Match
DLP11SA670HL2□	67ohm ±20%	150mA	5Vdc	100M ohm	12.5Vdc	1.2ohm±25%	Kit		UD	Imp. Match
DLP11SA900HL2□	90ohm ±20%	150mA	5Vdc	100M ohm	12.5Vdc	1.4ohm±25%	Kit		UD	Imp. Match

Operating Temperature Range: -40°C to +85°C Number of Circuit: 1

HD: for high speed differential signal lines

UD: for ultra high speed differential signal lines

## ■ Impedance-Frequency Characteristics DLP11SN Series

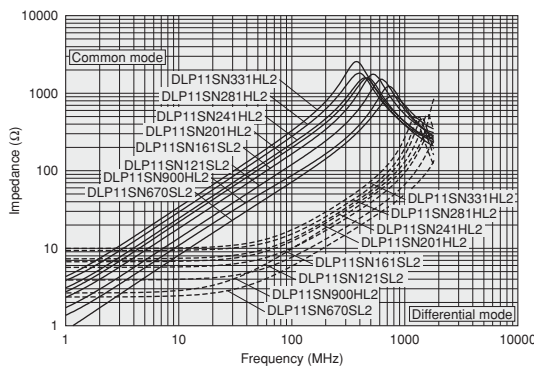

## DLP11SA Series

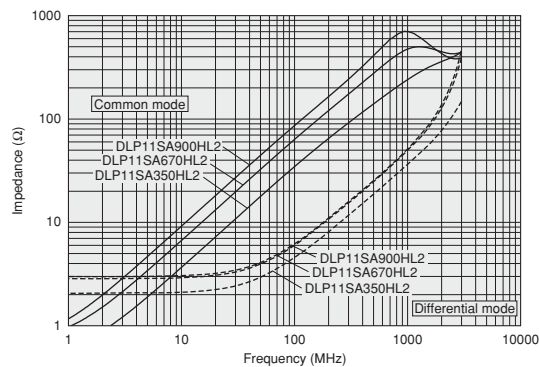

Continued on the following page.

△Note • Please read rating and △CAUTION (for storage, operating, rating, soldering, mounting and handling) in this catalog to prevent smoking and/or burning, etc.  
• This catalog has only typical specifications. Therefore, please approve our product specifications or transact the approval sheet for product specifications before ordering.

**Differential Mode Transmission Characteristics (Typ.)**

DLP11SN Series

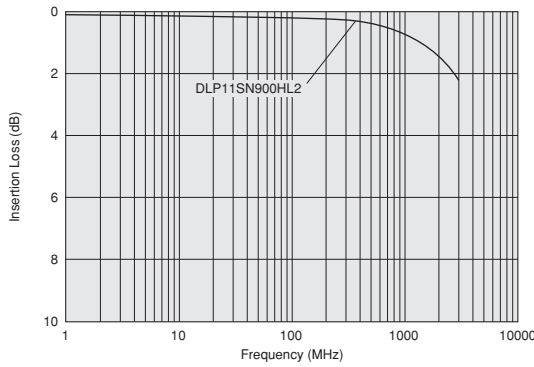

DLP11SA Series

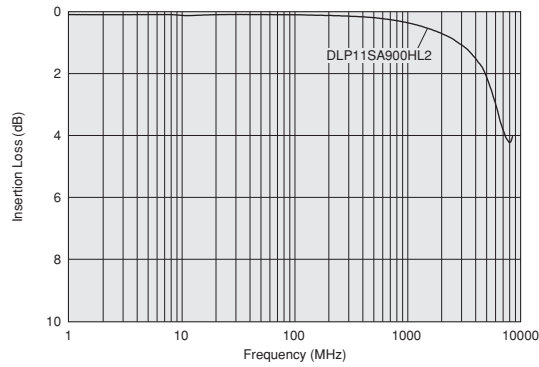

**Rated Value (□: packaging code)**

Part Number	Common Mode Impedance (at 100MHz/20°C)	Rated Current	Rated Voltage	Insulation Resistance (min.)	Withstand Voltage	DC Resistance	
DLP11RN450UL2□	45ohm ±25%	100mA	5Vdc	100M ohm	12.5Vdc	0.8ohm±25%	Kit HD
DLP11RB150UL2□	15ohm ±5ohm	100mA	5Vdc	100M ohm	12.5Vdc	0.8ohm±25%	Kit UD
DLP11RB400UL2□	40ohm ±10ohm	100mA	5Vdc	100M ohm	12.5Vdc	1.3ohm±25%	Kit UD

Operating Temperature Range: -40°C to +85°C Number of Circuit: 1 HD: for high speed differential signal lines UD: for ultra high speed differential signal lines

Differential mode to common mode conversion characteristic (Scd21) at 2.5GHz

DLP11RB: -40dB

Impedance Characteristics between signal lines Z0 (TDR at 50ps)

DLP11RB: 90ohm±15ohm

**Impedance-Frequency Characteristics**

DLP11RN Series

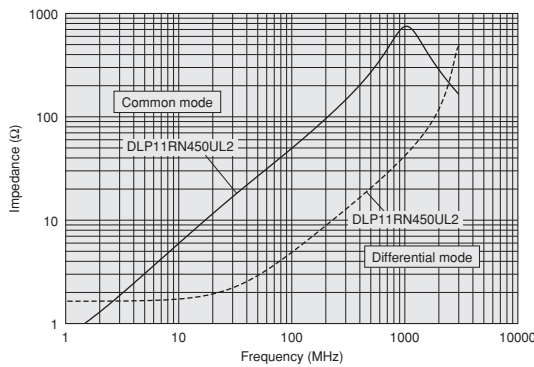

DLP11RB Series

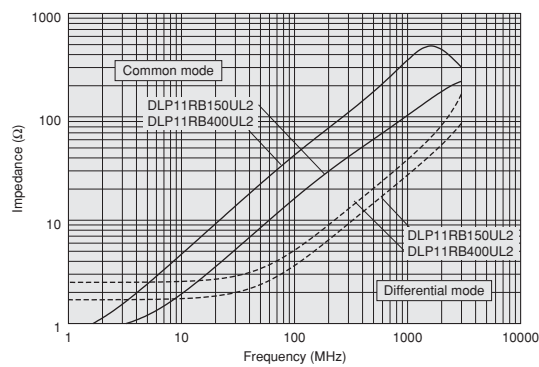

**Differential Mode Transmission Characteristics (Typ.)**

DLP11RN Series

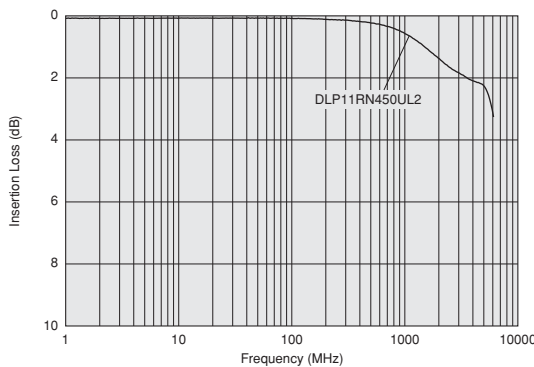

DLP11RB Series

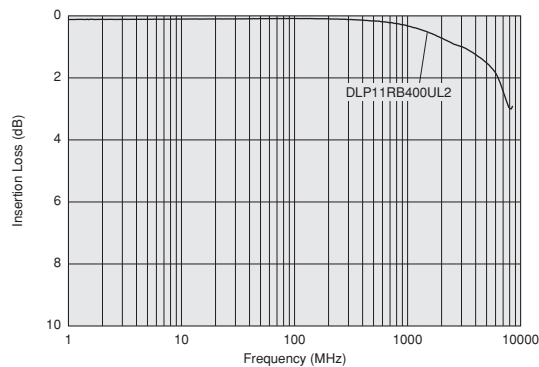

Continued on the following page.

△Note • Please read rating and △CAUTION (for storage, operating, rating, soldering, mounting and handling) in this catalog to prevent smoking and/or burning, etc.  
 • This catalog has only typical specifications. Therefore, please approve our product specifications or transact the approval sheet for product specifications before ordering.

Chip Ferrite Bead  
Chip EMIFIL®  
Chip Common Mode Choke Coil Signal Lines Type  
Block Type EMIFIL®  
Microwave Absorber



■ Rated Value (□: packaging code)

Part Number	Common Mode Impedance (at 100MHz/20°C)	Rated Current	Rated Voltage	Insulation Resistance (min.)	Withstand Voltage	DC Resistance	
DLP11TB800UL2□	80ohm ±25%	100mA	5Vdc	100M ohm	12.5Vdc	1.5ohm±25%	Kit UD

Operating Temperature Range: -40°C to +85°C Number of Circuit: 1  
 Differential mode to common mode conversion characteristic (Scd21) at 2.5GHz  
 DLP11TB: -40dB  
 Impedance Characteristics between signal lines Z0 (TDR at 50ps)  
 DLP11TB: 90ohm±15ohm

■ Impedance-Frequency Characteristics  
 DLP11TB Series

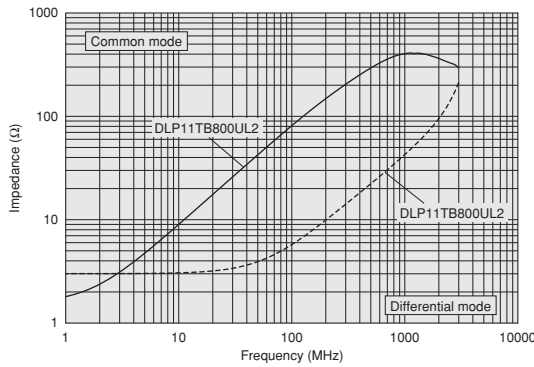

■ Differential Mode Transmission Characteristics (Typ.)  
 DLP11TB Series

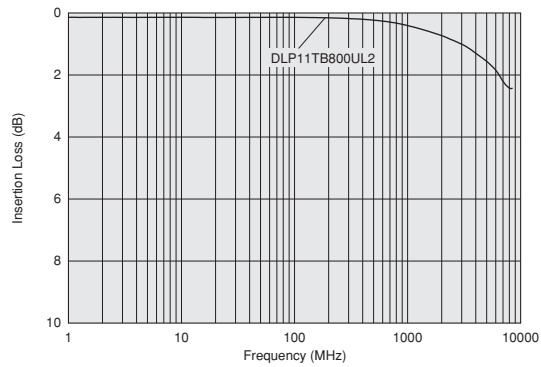

⚠Note • Please read rating and ⚠CAUTION (for storage, operating, rating, soldering, mounting and handling) in this catalog to prevent smoking and/or burning, etc.  
 • This catalog has only typical specifications. Therefore, please approve our product specifications or transact the approval sheet for product specifications before ordering.

# DLP31S Series 1206/3216 (inch/mm)



1206 size film type chip common mode choke coil.



### ■ Dimensions

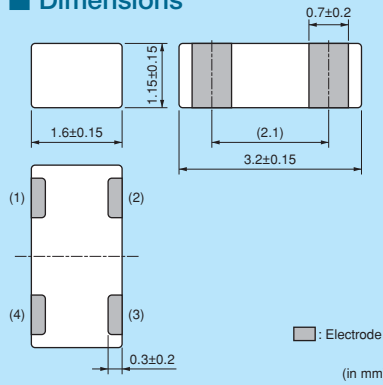

### ■ Equivalent Circuit

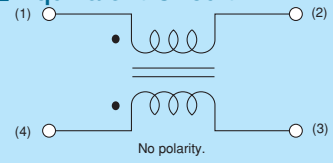

### ■ Packaging

Code	Packaging	Minimum Quantity
L	180mm Reel Embossed Tape	3000
B	Bulk(Bag)	500

Refer to pages from p.205 to p.209 for mounting information.

### ■ Rated Value (□: packaging code)

Part Number	Common Mode Impedance (at 100MHz/20°C)	Rated Current	Rated Voltage	Insulation Resistance (min.)	Withstand Voltage	DC Resistance	
DLP31SN121ML2□	120ohm ±20%	100mA	16Vdc	100M ohm	40Vdc	2.0ohm max.	<b>HD</b>
DLP31SN221ML2□	220ohm ±20%	100mA	16Vdc	100M ohm	40Vdc	2.5ohm max.	<b>HD</b>
DLP31SN551ML2□	550ohm ±20%	100mA	16Vdc	100M ohm	40Vdc	3.6ohm max.	<b>HD</b>

Operating Temperature Range: -40°C to +85°C Number of Circuit: 1

HD: for high speed differential signal lines UD: for ultra high speed differential signal lines

### ■ Impedance-Frequency Characteristics

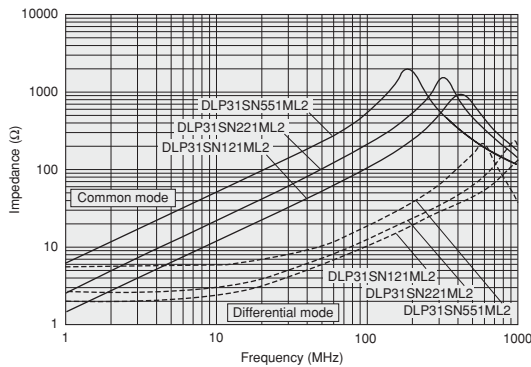

△Note • Please read rating and △CAUTION (for storage, operating, rating, soldering, mounting and handling) in this catalog to prevent smoking and/or burning, etc.  
 • This catalog has only typical specifications. Therefore, please approve our product specifications or transact the approval sheet for product specifications before ordering.

Chip Ferrite Bead  
Chip EMIFIL®  
Chip Common Mode Choke Coil  
Signal Lines Type  
Block Type EMIFIL®  
Microwave Absorber

# DLP1ND Series 05025/1506 (inch/mm)



2 circuits in 05025 size, adapt to HDMI line.

### ■ Dimensions

Legend:  Electrode (in mm)

### ■ Equivalent Circuit

### ■ Packaging

Code	Packaging	Minimum Quantity
L	180mm Reel Embossed Tape	5000
B	Bulk(Bag)	500

Refer to pages from p.205 to p.209 for mounting information.

### ■ Rated Value (□: packaging code)

Part Number	Common Mode Impedance (at 100MHz/20°C)	Rated Current	Rated Voltage	Insulation Resistance (min.)	Withstand Voltage	DC Resistance	
DLP1NDN350HL4□	35ohm ±20%	100mA	5Vdc	100M ohm	12.5Vdc	1.8ohm±25%	Kit HD UHP
DLP1NDN670HL4□	67ohm ±20%	80mA	5Vdc	100M ohm	12.5Vdc	2.9ohm±25%	Kit HD UHP
DLP1NDN900HL4□	90ohm ±20%	60mA	5Vdc	100M ohm	12.5Vdc	3.7ohm±25%	Kit HD UHP

Operating Temperature Range: -40°C to +85°C Number of Circuit: 2

HD: for high speed differential signal lines UD: for ultra high speed differential signal lines

### ■ Impedance-Frequency Characteristics

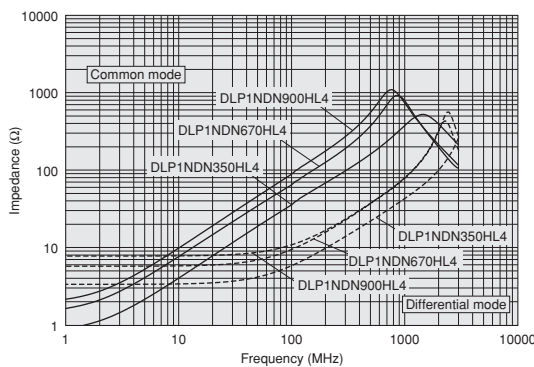

### ■ Differential Mode Transmission Characteristics (Typ.)

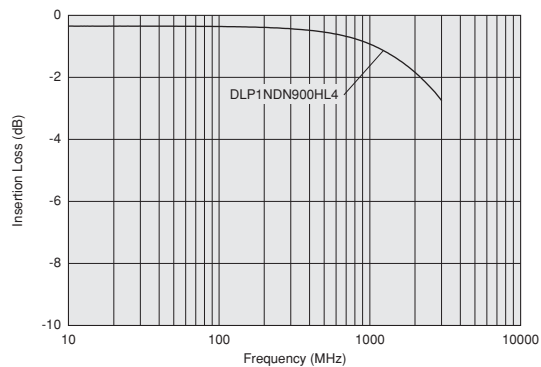

⚠Note • Please read rating and ⚠CAUTION (for storage, operating, rating, soldering, mounting and handling) in this catalog to prevent smoking and/or burning, etc.  
• This catalog has only typical specifications. Therefore, please approve our product specifications or transact the approval sheet for product specifications before ordering.

# DLP2AD Series 0804/2010 (inch/mm)



2 circuit built-in, 0804 size, HDMI adapted type available, cut-off frequency 6GHz max.

### ■ Dimensions

0.25±0.1, 0.5±0.1, 0.92±0.1, 0.25±0.15, 1.0±0.1, 2.0±0.1

□ : Electrode (in mm)

### ■ Equivalent Circuit

### ■ Packaging

Code	Packaging	Minimum Quantity
L	180mm Reel Embossed Tape	3000
B	Bulk (Bag)	500

Refer to pages from p.205 to p.209 for mounting information.

## ■ Rated Value (□: packaging code)

Part Number	Common Mode Impedance (at 100MHz/20°C)	Rated Current	Rated Voltage	Insulation Resistance (min.)	Withstand Voltage	DC Resistance	
DLP2ADA350HL4□	35ohm ±20%	150mA	5Vdc	100M ohm	12.5Vdc	0.8ohm±25%	Kit UD
DLP2ADA670HL4□	67ohm ±20%	130mA	5Vdc	100M ohm	12.5Vdc	1.0ohm±25%	Kit UD
DLP2ADA900HL4□	90ohm ±20%	120mA	5Vdc	100M ohm	12.5Vdc	1.4ohm±25%	Kit UD
DLP2ADN670HL4□	67ohm ±20%	140mA	5Vdc	100M ohm	12.5Vdc	1.3ohm±25%	Kit HD
DLP2ADN900HL4□	90ohm ±20%	130mA	5Vdc	100M ohm	12.5Vdc	1.7ohm±25%	Kit HD
DLP2ADN121HL4□	120ohm ±20%	120mA	5Vdc	100M ohm	12.5Vdc	2.0ohm±25%	Kit HD
DLP2ADN161HL4□	160ohm ±20%	100mA	5Vdc	100M ohm	12.5Vdc	2.5ohm±25%	Kit HD
DLP2ADN201HL4□	200ohm ±20%	90mA	5Vdc	100M ohm	12.5Vdc	3.2ohm±25%	Kit HD
DLP2ADN241HL4□	240ohm ±20%	80mA	5Vdc	100M ohm	12.5Vdc	3.8ohm±25%	Kit HD
DLP2ADN281HL4□	280ohm ±20%	80mA	5Vdc	100M ohm	12.5Vdc	4.6ohm±25%	Kit HD

Operating Temperature Range: -40°C to +85°C Number of Circuit: 2

HD: for high speed differential signal lines

UD: for ultra high speed differential signal lines

## ■ Impedance-Frequency Characteristics

### DLP2ADA Series

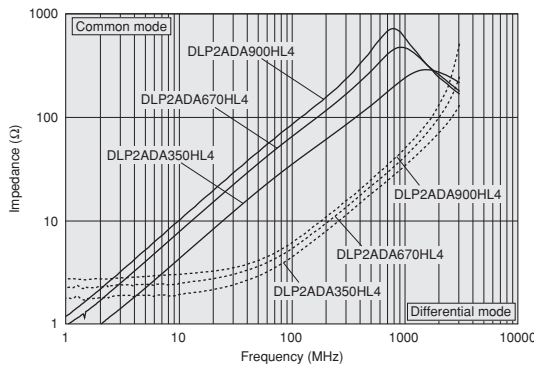

### DLP2ADN Series

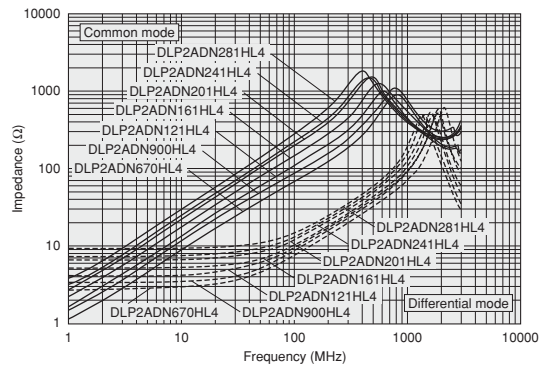

Continued on the following page.

△Note • Please read rating and △CAUTION (for storage, operating, rating, soldering, mounting and handling) in this catalog to prevent smoking and/or burning, etc.  
 • This catalog has only typical specifications. Therefore, please approve our product specifications or transact the approval sheet for product specifications before ordering.

■ Differential Mode Transmission Characteristics (Typ.)

DLP2ADA Series

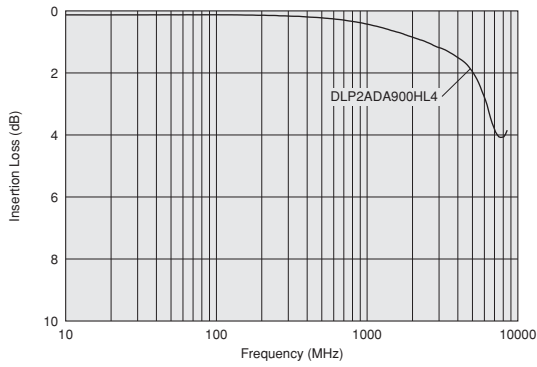

DLP2ADN Series

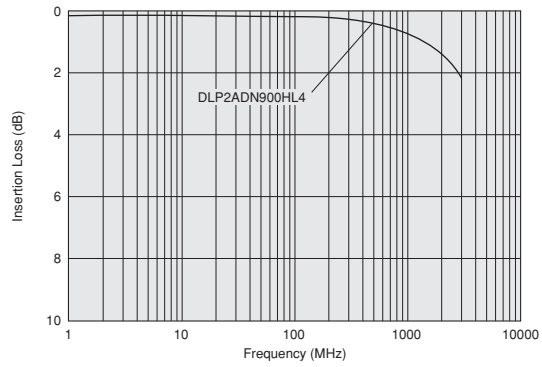

Chip Ferrite Bead

Chip EMIFIL®

Signal Lines Type  
 Chip Common Mode Choke Coil

Block Type EMIFIL®

Microwave Absorber

⚠Note • Please read rating and ⚠CAUTION (for storage, operating, rating, soldering, mounting and handling) in this catalog to prevent smoking and/or burning, etc.  
 • This catalog has only typical specifications. Therefore, please approve our product specifications or transact the approval sheet for product specifications before ordering.

# DLP31D Series 1206/3216 (inch/mm)



2 circuit built-in, 1206 size, meet IEEE1394, USB, LVDS.



### Dimensions

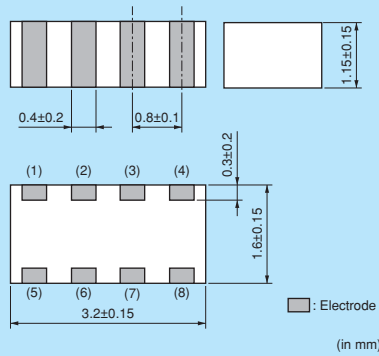

### Equivalent Circuit

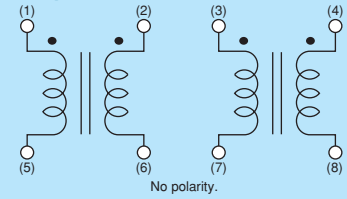

### Packaging

Code	Packaging	Minimum Quantity
L	180mm Reel Embossed Tape	3000
B	Bulk(Bag)	500

Refer to pages from p.205 to p.209 for mounting information.

### Rated Value (□: packaging code)

Part Number	Common Mode Impedance (at 100MHz/20°C)	Rated Current	Rated Voltage	Insulation Resistance (min.)	Withstand Voltage	DC Resistance	
DLP31DN900ML4□	90ohm ±20%	160mA	10Vdc	100M ohm	25Vdc	1.1ohm max.	HD
DLP31DN131ML4□	130ohm ±20%	120mA	10Vdc	100M ohm	25Vdc	1.1ohm max.	HD
DLP31DN201ML4□	200ohm ±20%	100mA	10Vdc	100M ohm	25Vdc	2.2ohm max.	HD
DLP31DN321ML4□	320ohm ±20%	80mA	10Vdc	100M ohm	25Vdc	3.5ohm max.	HD
DLP31DN441ML4□	440ohm ±20%	70mA	10Vdc	100M ohm	25Vdc	4.3ohm max.	HD

Operating Temperature Range: -40°C to +85°C Number of Circuit: 2

HD: for high speed differential signal lines UD: for ultra high speed differential signal lines

### Impedance-Frequency Characteristics

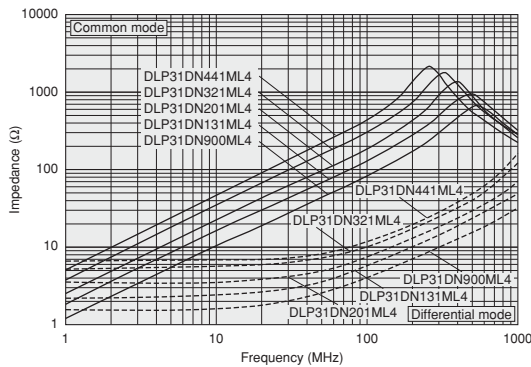

△Note • Please read rating and △CAUTION (for storage, operating, rating, soldering, mounting and handling) in this catalog to prevent smoking and/or burning, etc.  
 • This catalog has only typical specifications. Therefore, please approve our product specifications or transact the approval sheet for product specifications before ordering.

Chip Ferrite Bead

Chip EMIFIL®

Chip Common Mode Choke Coil  
Signal Lines Type

Block Type EMIFIL®

Microwave Absorber

# DLW21S Series 0805/2012 (inch/mm)



Wire-wound common choke, HDMI available type prepared.

### ■ Dimensions

(in mm)

### ■ Equivalent Circuit

No polarity.

### ■ Packaging

Code	Packaging	Minimum Quantity
L	180mm Reel Embossed Tape	2000
B	Bulk(Bag)	500

Refer to pages from p.205 to p.209 for mounting information.

### ■ Rated Value (□: packaging code)

Part Number	Common Mode Impedance (at 100MHz/20°C)	Rated Current	Rated Voltage	Insulation Resistance (min.)	Withstand Voltage	DC Resistance	
DLW21SN670SQ2□	67ohm ±25%	400mA	50Vdc	10M ohm	125Vdc	0.25ohm max.	Kit HD
DLW21SN900SQ2□	90ohm ±25%	330mA	50Vdc	10M ohm	125Vdc	0.35ohm max.	Kit HD
DLW21SN121SQ2□	120ohm ±25%	370mA	50Vdc	10M ohm	125Vdc	0.30ohm max.	Kit HD
DLW21SN181SQ2□	180ohm ±25%	330mA	50Vdc	10M ohm	125Vdc	0.35ohm max.	Kit HD
DLW21SN261SQ2□	260ohm ±25%	300mA	50Vdc	10M ohm	125Vdc	0.40ohm max.	Kit HD
DLW21SN371SQ2□	370ohm ±25%	280mA	50Vdc	10M ohm	125Vdc	0.45ohm max.	Kit HD
DLW21SN501SK2□	500ohm ±25%	250mA	50Vdc	10M ohm	125Vdc	0.5ohm max.	Kit HD

Operating Temperature Range: -40°C to +85°C Number of Circuit: 1

HD: for high speed differential signal lines UD: for ultra high speed differential signal lines

### ■ Impedance-Frequency Characteristics DLW21SN\_SQ2/SK2 Series

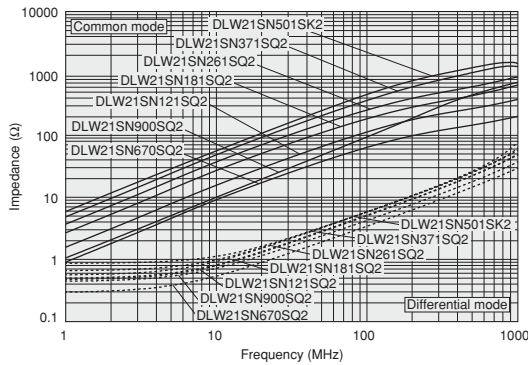

### ■ Rated Value (□: packaging code)

Part Number	Common Mode Impedance (at 100MHz/20°C)	Rated Current	Rated Voltage	Insulation Resistance (min.)	Withstand Voltage	DC Resistance	
DLW21SN670HQ2□	67ohm ±25%	320mA	20Vdc	10M ohm	50Vdc	0.31ohm max.	Kit UD Imp
DLW21SN900HQ2□	90ohm ±25%	280mA	20Vdc	10M ohm	50Vdc	0.41ohm max.	Kit UD Imp
DLW21SN121HQ2□	120ohm ±25%	280mA	20Vdc	10M ohm	50Vdc	0.41ohm max.	Kit UD Imp
DLW21SR670HQ2□	67ohm ±25%	400mA	20Vdc	10M ohm	50Vdc	0.25ohm max.	Kit UD Imp

Operating Temperature Range: -40°C to +85°C Number of Circuit: 1

HD: for high speed differential signal lines UD: for ultra high speed differential signal lines

DLW21SR670HQ2 is designed to correct line impedance when ESD protection device is also used.

Continued on the following page.

△Note • Please read rating and △CAUTION (for storage, operating, rating, soldering, mounting and handling) in this catalog to prevent smoking and/or burning, etc.  
• This catalog has only typical specifications. Therefore, please approve our product specifications or transact the approval sheet for product specifications before ordering.

**Impedance-Frequency Characteristics**  
**DLW21SN\_HQ2 Series**

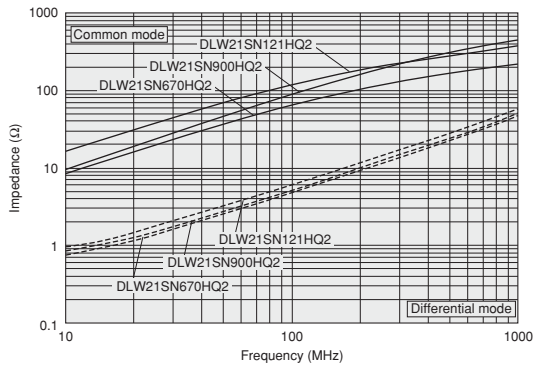

**DLW21SR\_HQ2 Series**

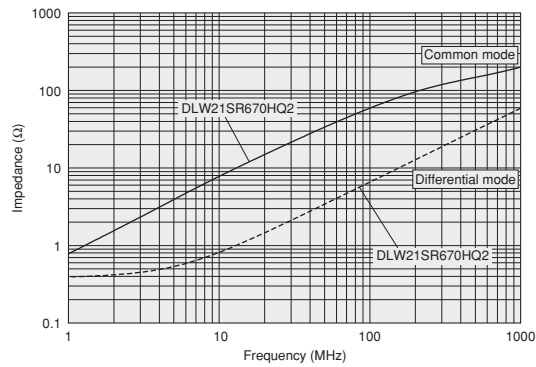

**Differential Mode Transmission Characteristics (Typ.)**  
**DLW21SN\_HQ2 Series**

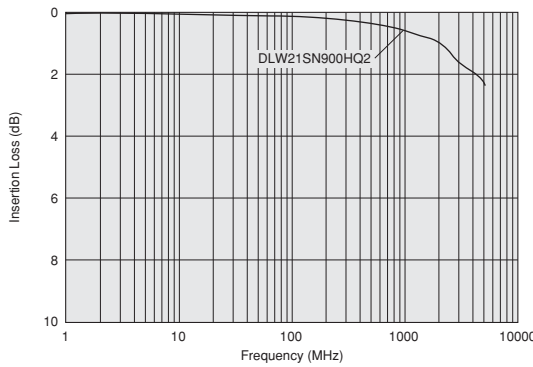

**Rated Value (□: packaging code)**

Part Number	Common Mode Impedance (at 100MHz/20°C)	Rated Current	Rated Voltage	Insulation Resistance (min.)	Withstand Voltage	DC Resistance	
DLW21SN181XQ2□	180ohm ±25%	240mA	20Vdc	10M ohm	50Vdc	0.39ohm max.	New Kit HD
DLW21SN261XQ2□	260ohm ±25%	220mA	20Vdc	10M ohm	50Vdc	0.59ohm max.	New Kit HD
DLW21SN491XQ2□	490ohm ±25%	190mA	20Vdc	10M ohm	50Vdc	0.77ohm max.	New Kit HD

Operating Temperature Range: -40°C to +85°C Number of Circuit: 1

HD: for high speed differential signal lines UD: for ultra high speed differential signal lines

**Impedance-Frequency Characteristics**  
**DLW21SN\_XQ2 Series**

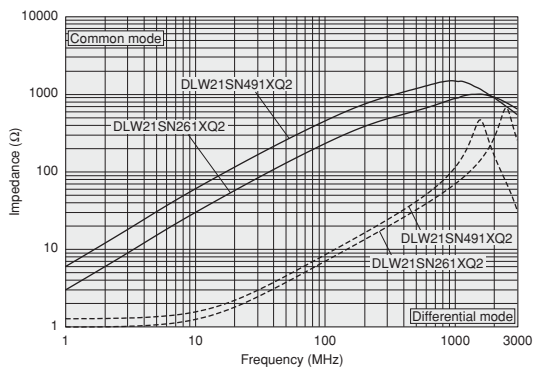

**Differential Mode Transmission Characteristics (Typ.)**  
**DLW21SN\_XQ2 Series**

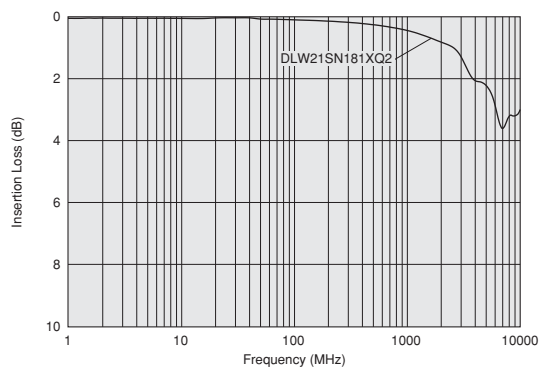

△Note • Please read rating and △CAUTION (for storage, operating, rating, soldering, mounting and handling) in this catalog to prevent smoking and/or burning, etc.  
• This catalog has only typical specifications. Therefore, please approve our product specifications or transact the approval sheet for product specifications before ordering.

Chip Ferrite Bead

Chip EMIFIL®

Chip Common Mode Choke Coil  
Signal Lines Type

Block Type EMIFIL®

Microwave Absorber



# DLW21H Series 0805/2012 (inch/mm)



Low profile wire-wound common choke coil, HDMI available type prepared.

### ■ Dimensions

(in mm)

### ■ Equivalent Circuit

### ■ Packaging

Code	Packaging	Minimum Quantity
L	180mm Reel Embossed Tape	3000
B	Bulk(Bag)	500

Refer to pages from p.205 to p.209 for mounting information.

### ■ Rated Value (□: packaging code)

Part Number	Common Mode Impedance (at 100MHz/20°C)	Rated Current	Rated Voltage	Insulation Resistance (min.)	Withstand Voltage	DC Resistance	
DLW21HN670SQ2□	67ohm ±25%	330mA	50Vdc	10M ohm	125Vdc	0.35ohm max.	Kit HD
DLW21HN900SQ2□	90ohm ±25%	330mA	50Vdc	10M ohm	125Vdc	0.35ohm max.	Kit HD
DLW21HN121SQ2□	120ohm ±25%	280mA	50Vdc	10M ohm	125Vdc	0.45ohm max.	Kit HD
DLW21HN181SQ2□	180ohm ±25%	250mA	50Vdc	10M ohm	125Vdc	0.50ohm max.	Kit HD
DLW21HN670HQ2□	67ohm ±25%	240mA	20Vdc	10M ohm	50Vdc	0.49ohm max.	Kit UD
DLW21HN900HQ2□	90ohm ±25%	220mA	20Vdc	10M ohm	50Vdc	0.59ohm max.	Kit UD
DLW21HN121HQ2□	120ohm ±25%	200mA	20Vdc	10M ohm	50Vdc	0.68ohm max.	Kit UD

Operating Temperature Range: -40°C to +85°C Number of Circuit: 1

HD: for high speed differential signal lines

UD: for ultra high speed differential signal lines

### ■ Impedance-Frequency Characteristics

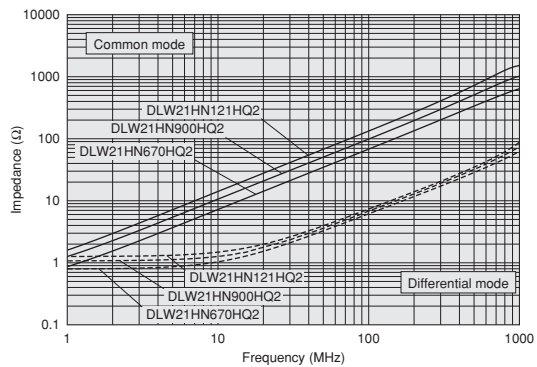
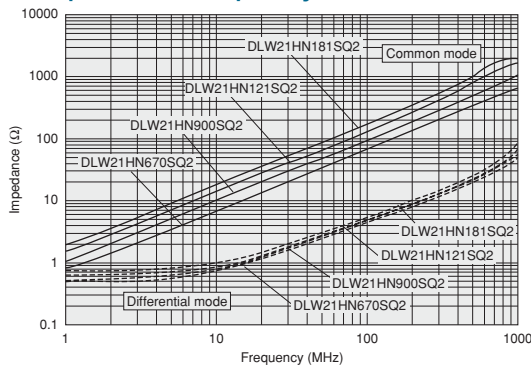

### ■ Differential Mode Transmission Characteristics (Typ.)

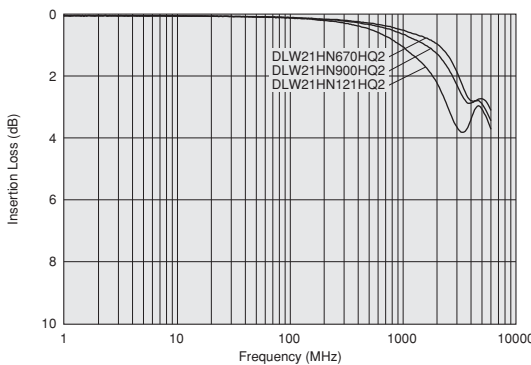

⚠Note • Please read rating and ⚠CAUTION (for storage, operating, rating, soldering, mounting and handling) in this catalog to prevent smoking and/or burning, etc.  
• This catalog has only typical specifications. Therefore, please approve our product specifications or transact the approval sheet for product specifications before ordering.

# DLW31S Series 1206/3216 (inch/mm)



## 1206 size wire-wound common mode choke coil.



### ■ Dimensions

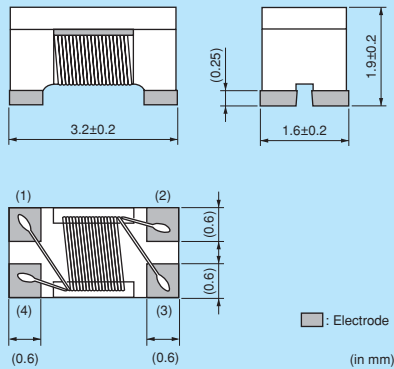

### ■ Equivalent Circuit

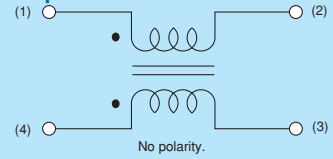

### ■ Packaging

Code	Packaging	Minimum Quantity
L	180mm Reel Embossed Tape	2000
B	Bulk(Bag)	500

Refer to pages from p.205 to p.209 for mounting information.

### ■ Rated Value (□: packaging code)

Part Number	Common Mode Impedance (at 100MHz/20°C)	Rated Current	Rated Voltage	Insulation Resistance (min.)	Withstand Voltage	DC Resistance	
DLW31SN900SQ2□	90ohm ±25%	370mA	50Vdc	10M ohm	125Vdc	0.3ohm max.	HD
DLW31SN161SQ2□	160ohm ±25%	340mA	50Vdc	10M ohm	125Vdc	0.4ohm max.	HD
DLW31SN261SQ2□	260ohm ±25%	310mA	50Vdc	10M ohm	125Vdc	0.5ohm max.	HD
DLW31SN601SQ2□	600ohm ±25%	260mA	50Vdc	10M ohm	125Vdc	0.8ohm max.	HD
DLW31SN102SQ2□	1000ohm ±25%	230mA	50Vdc	10M ohm	125Vdc	1.0ohm max.	HD
DLW31SN222SQ2□	2200ohm ±25%	200mA	50Vdc	10M ohm	125Vdc	1.2ohm max.	HD

Operating Temperature Range: -40°C to +85°C Number of Circuit: 1

HD: for high speed differential signal lines UD: for ultra high speed differential signal lines

### ■ Impedance-Frequency Characteristics

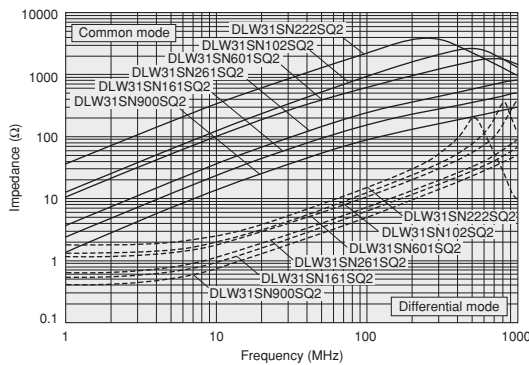

△Note • Please read rating and △CAUTION (for storage, operating, rating, soldering, mounting and handling) in this catalog to prevent smoking and/or burning, etc.  
 • This catalog has only typical specifications. Therefore, please approve our product specifications or transact the approval sheet for product specifications before ordering.

Chip Ferrite Bead

Chip EMIFIL®

Chip Common Mode Choke Coil  
Signal Lines Type

Block Type EMIFIL®

Microwave Absorber

# DLW43S Series 1812/4532 (inch/mm)



## 1812 size wire-wound common choke, Automotive Type.

**DLW43S\_XK**



**■ Dimensions**

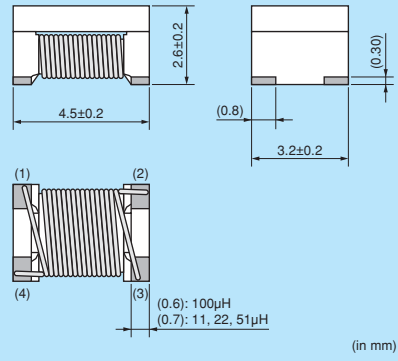

(in mm)

**■ Equivalent Circuit**

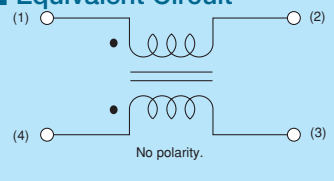

No polarity.

**■ Packaging**

Code	Packaging	Minimum Quantity
L	180mm Reel Embossed Tape	500
K	330mm Reel Embossed Tape	2500
B	Bulk(Bag)	100

**DLW43S\_XP**



**■ Dimensions**

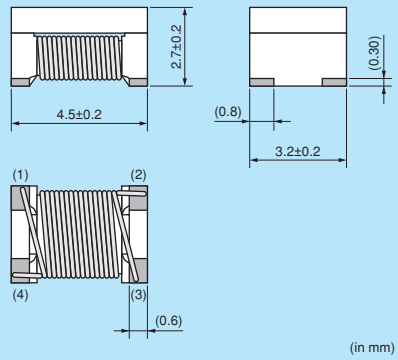

(in mm)

**■ Equivalent Circuit**

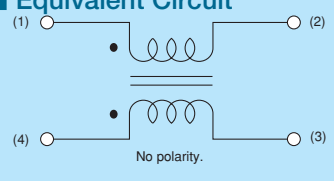

No polarity.

**■ Packaging**

Code	Packaging	Minimum Quantity
L	180mm Reel Embossed Tape	500
K	330mm Reel Embossed Tape	2500
B	Bulk(Bag)	100

Refer to pages from p.205 to p.209 for mounting information.

**■ Rated Value** (□: packaging code)

Part Number	Common Mode Inductance	Rated Current	Rated Voltage	Insulation Resistance (min.)	Withstand Voltage	DC Resistance	Operating Temperature Range
DLW43SH110XK2□	11μH -30%/+50% (at 0.1MHz)	360mA	50Vdc	10M ohm	125Vdc	0.5ohm max.	-40°C to +125°C
DLW43SH220XK2□	22μH -30%/+50% (at 0.1MHz)	310mA	50Vdc	10M ohm	125Vdc	0.6ohm max.	-40°C to +125°C
DLW43SH510XK2□	51μH -30%/+50% (at 1MHz)	230mA	50Vdc	10M ohm	125Vdc	1.0ohm max.	-40°C to +125°C
DLW43SH101XK2□	100μH -30%/+50% (at 1MHz)	200mA	50Vdc	10M ohm	125Vdc	2.0ohm max.	-40°C to +125°C
DLW43SH101XP2□	100μH -30%/+80% (at 0.1MHz)	170mA	50Vdc	10M ohm	125Vdc	2.0ohm max.	-40°C to +125°C

Number of Circuit: 1

**■ Impedance-Frequency Characteristics**

**DLW43S\_XK Series**

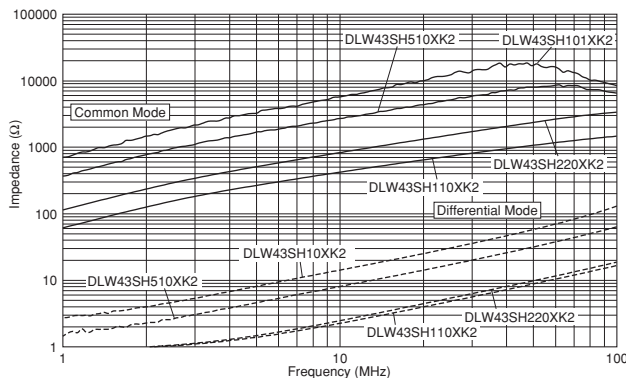

**DLW43S\_XP Series**

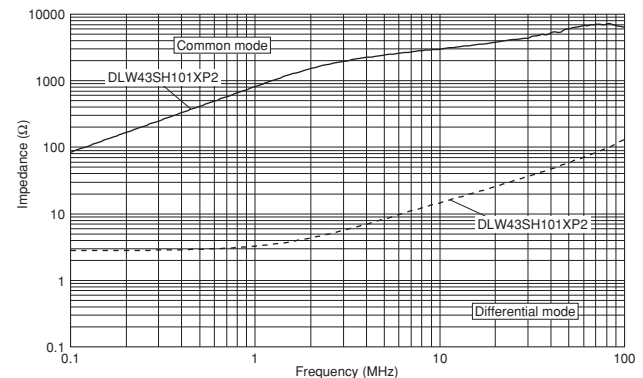

△Note • Please read rating and ⚠CAUTION (for storage, operating, rating, soldering, mounting and handling) in this catalog to prevent smoking and/or burning, etc.  
 • This catalog has only typical specifications. Therefore, please approve our product specifications or transact the approval sheet for product specifications before ordering.

# PLT10H Series (12.9x6.6mm)



Automotive application available, up to 18A.

### ■ Dimensions

□ : Electrode (in mm)

### ■ Equivalent Circuit

### ■ Packaging

Code	Packaging	Minimum Quantity
L	180mm Reel Embossed Tape	125
K	330mm Reel Embossed Tape	500
B	Bulk (Bag)	50

Refer to pages from p.210 to p.211 for mounting information.

### ■ Rated Value (□: packaging code)

Part Number	Common Mode Impedance (at 10MHz/20°C)	Rated Current	Rated Voltage	Insulation Resistance (min.)	Withstand Voltage	DC Resistance	Inductance	Kit	≥
PLT10HH450180PN□	45ohm (Typ.)	18A	300Vdc	10M ohm	750Vdc	1.3m ohm±0.5m ohm	0.8μH min.	Kit	≥10A
PLT10HH101150PN□	100ohm (Typ.)	15A	300Vdc	10M ohm	750Vdc	1.8m ohm±0.5m ohm	2.0μH min.	Kit	≥10A
PLT10HH401100PN□	400ohm (Typ.)	10A	100Vdc	10M ohm	250Vdc	3.6m ohm±0.5m ohm	6μH min.	Kit	≥10A
PLT10HH501100PN□	500ohm (Typ.)	10A	100Vdc	10M ohm	250Vdc	3.6m ohm±0.5m ohm	9μH min.	Kit	≥10A
PLT10HH9016R0PN□	900ohm (Typ.)	6A	100Vdc	10M ohm	250Vdc	8.0m ohm±0.5m ohm	14μH min.	Kit	≥3A
PLT10HH1026R0PN□	1000ohm (Typ.)	6A	100Vdc	10M ohm	250Vdc	8.0m ohm±0.5m ohm	20μH min.	Kit	≥3A

Operating Temperature Range (Self-temperature rise is included): -55°C to +105°C (PLT10HH 501100/1026R0 PN), -55°C to +125°C (PLT10HH 450180/101150/401100/9016R0 PN) Number of Circuit: 1

### ■ Impedance-Frequency Characteristics

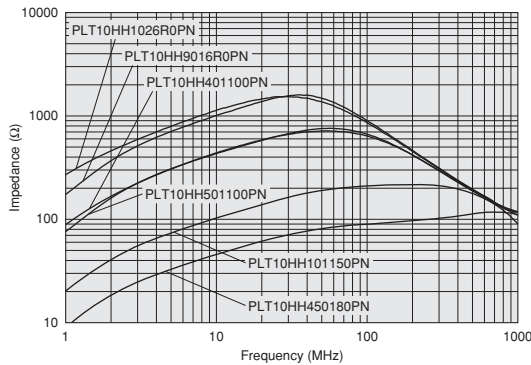

### ■ Notice (Rating)

In operating temperature exceeding +65°C, derating of current is necessary for PLT10H series.

Please apply the derating curve shown in chart according to the operating temperature.

#### Derating of Rated Current

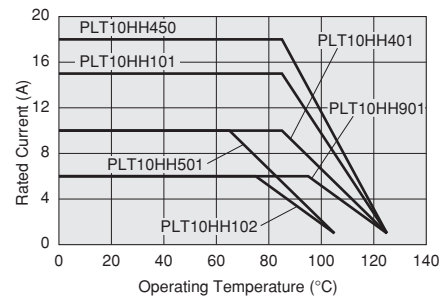

△Note • Please read rating and △CAUTION (for storage, operating, rating, soldering, mounting and handling) in this catalog to prevent smoking and/or burning, etc.  
• This catalog has only typical specifications. Therefore, please approve our product specifications or transact the approval sheet for product specifications before ordering.

Chip Ferrite Bead

Chip EMIFIL®

Chip Common Mode Choke Coil Power Lines Type

Block Type EMIFIL®

Microwave Absorber

## ⚠ Caution

## ● Rating

Do not use products beyond the rated current and rated voltage as this may create excessive heat and deteriorate the insulation resistance. Be sure to provide an appropriate fail-safe function on your product to prevent a second damage that may be caused by the abnormal function or the failure our product.

## ● Soldering and Mounting

## 1. Self-heating

Please provide special attention when mounting chip common mode choke coils DLW5 series in close proximity to other products that radiate heat.

The heat generated by other products may deteriorate the insulation resistance and cause excessive heat in this component.

## 2. Mounting Direction

Mount Chip Common Mode Choke Coils in right direction. Wrong direction, which is 90 degrees rotated from right direction, causes not only open or short circuit but also flames or other serious trouble.

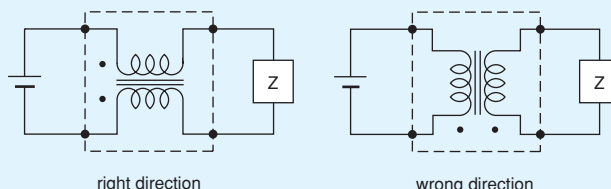

## Notice

## ● Storage and Operating Conditions

## &lt;Operating Environment&gt;

Do not use products in a chemical atmosphere such as chlorine gas, acid or sulfide gas.

Do not use products in the environment close to the organic solvent.

## &lt;Storage and Handling Requirements&gt;

## 1. Storage Period

DLM11G series should be used within 6 months, the other series should be used within 12 months.

Solderability should be checked if this period is exceeded.

## 2. Storage Conditions

## (1) Storage temperature: -10 to +40°C

Relative humidity: 15 to 85%

Avoid sudden changes in temperature and humidity.

## (2) Do not store products in a chemical atmosphere such as chlorine gas, acid or sulfide gas.

## ● Notice (Soldering and Mounting)

## 1. Cleaning

Failure and degradation of a product are caused by the cleaning method. When you clean in conditions that are not in mounting information, please contact Murata engineering.

## 2. Soldering

Reliability decreases with improper soldering methods. Please solder by the standard soldering conditions shown in mounting information.

## 3. Other

Noise suppression levels resulting from Murata's EMI suppression filters EMIFIL® may vary, depending on the circuits and ICs used, type of noise, mounting pattern, mounting location, and other operating conditions. Be sure to check and confirm in advance the noise suppression effect of each filter, in actual circuits, etc. before applying the filter in a commercial-purpose equipment design.

## ● Handling

## 1. Resin Coating (Except for DLW Series.)

Using resin for coating/molding products may affect the products performance.

So please pay careful attention in selecting resin.

Prior to use, please make the reliability evaluation with the product mounted in your application set.

## 2. Resin Coating (DLW Series)

The impedance value may change due to high cure-stress of resin to be used for coating/molding products. An open circuit issue may occur by mechanical stress caused by the resin, amount/cured shape of resin, or operating condition etc. Some resin contains some impurities or chloride possible to generate chlorine by hydrolysis under some operating condition may cause corrosion of wire of coil, leading to open circuit.

So, please pay your careful attention in selecting resin in case of coating/molding the products with the resin. Prior to use the coating resin, please make sure no reliability issue is observed by evaluating products mounted on your board.

## 3. Caution for Use (DLW Series)

When you hold products with a tweezer, please hold by the sides. Sharp materials, such as a pair of tweezers, should not touch the winding portion to prevent breaking the wire. Mechanical shock should not be applied to the products mounted on the board to prevent breaking the core.

## 4. Brushing

When you clean the neighborhood of products such as connector pins, bristles of cleaning brush shall not be touched to the winding portion of this product to prevent the breaking of wire.

## 5. Handling of a Substrate

After mounting products on a substrate, do not apply any stress to the product caused by bending or twisting to the substrate when cropping the substrate, inserting and removing a connector from the substrate or tightening screw to the substrate. Excessive mechanical stress may cause cracking in the Product.

Bending

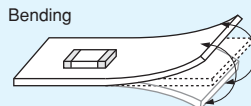

Twisting

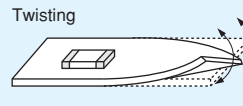

⚠ Note • Please read rating and ⚠ CAUTION (for storage, operating, rating, soldering, mounting and handling) in this catalog to prevent smoking and/or burning, etc.  
• This catalog has only typical specifications. Therefore, please approve our product specifications or transact the approval sheet for product specifications before ordering.

**⚠ Caution**

● **Rating**

1. Do not use products beyond the rated current and rated voltage as this may create excessive heat and deteriorate the insulation resistance.
2. Be sure to provide an appropriate fail-safe function on your product to prevent a second damage that may be caused by the abnormal function or the failure our product.

● **Soldering and Mounting**

1. Self-heating

Please provide special attention when mounting chip common mode choke coils in close proximity to other products that radiate heat. The heat generated by other products may deteriorate the insulation resistance and cause excessive heat in this component.

2. Mounting Direction

Mount Chip Common Mode Choke Coils in right direction. Wrong direction, which is 90 degrees rotated from right direction, causes not only open or short circuit but also flames or other serious trouble.

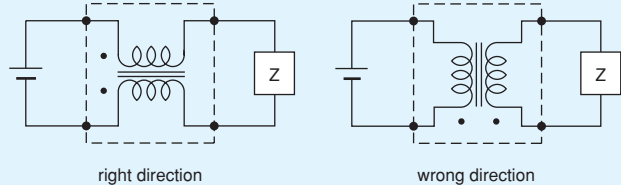

● **Storage and Operating Conditions**

<Operating Environment>

Do not use products in a chemical atmosphere such as chlorine gas, acid or sulfide gas.

Do not use products in the environment close to the organic solvent.

<Storage and Handling Requirements>

1. Storage Period

PLT10H series should be used within 12 months. Solderability should be checked if this period is exceeded.

2. Storage Conditions

- (1) Storage temperature: -10 to +40°C  
Relative humidity: 15 to 85%  
Avoid sudden changes in temperature and humidity.
- (2) Do not store products in a chemical atmosphere such as chlorine gas, acid or sulfide gas.

● **Notice (Soldering and Mounting)**

1. Cleaning

Failure and degradation of a product are caused by the cleaning method. When you clean in conditions that are not in mounting information, please contact Murata engineering.

2. Soldering

Reliability decreases with improper soldering methods. Please solder by the standard soldering conditions shown in mounting information.

3. Other

Noise suppression levels resulting from Murata's EMI suppression filters EMIFIL® may vary, depending on the circuits and ICs used, type of noise, mounting pattern, mounting location, and other operating conditions. Be sure to check and confirm in advance the noise suppression effect of each filter, in actual circuits, etc. before applying the filter in a commercial-purpose equipment design.

● **Handling**

1. Handling of a Substrate

After mounting products on a substrate, do not apply any stress to the product caused by bending or twisting to the substrate when cropping the substrate, inserting and removing a connector from the substrate or tightening screw to the substrate.

Excessive mechanical stress may cause cracking in the Product.

Bending

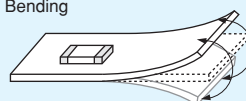

Twisting

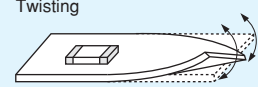

⚠ Note • Please read rating and ⚠ CAUTION (for storage, operating, rating, soldering, mounting and handling) in this catalog to prevent smoking and/or burning, etc.  
• This catalog has only typical specifications. Therefore, please approve our product specifications or transact the approval sheet for product specifications before ordering.

### 1. Standard Land Pattern Dimensions

Land Pattern + Solder Resist  
 Land Pattern  
 Solder Resist (in mm)

DLM11S  
 DLM11G  
 DLP0QS  
 DLP0NS  
 DLP11S  
 DLP11R  
 DLP11T  
 DLP1ND  
 DLP2AD  
 DLP31S  
 DLP31D  
 DLW21S  
 DLW21H  
 DLW31SN  
 DLW43S  
 DLW5A  
 DLW5B

#### ●Reflow and Flow DLP31S

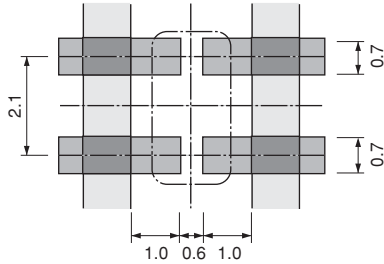

#### DLP31D

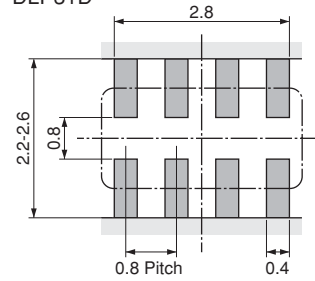

#### ●Reflow Soldering

##### DLP0QS

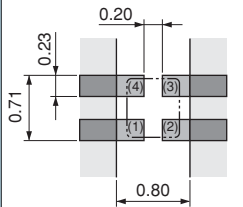

##### DLP0NS

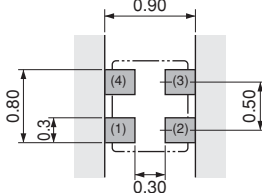

##### DLP11S/DLM11S

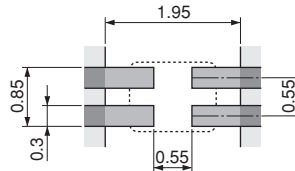

##### DLP11R/11T

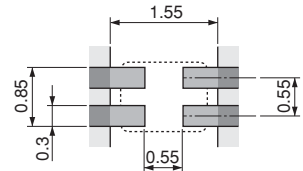

##### DLP1ND

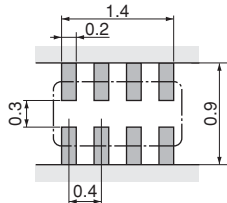

##### DLP2AD

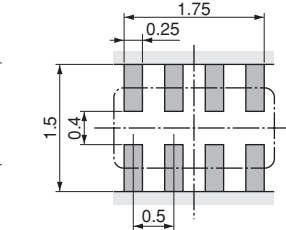

##### DLM11G

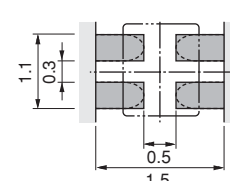

##### DLW21S/21H/31SN/43S

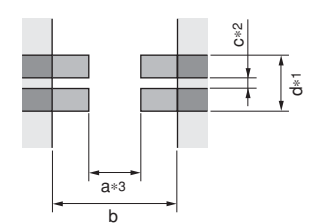

##### DLW5A/5B (Except for DLW5AT\_MQ2)

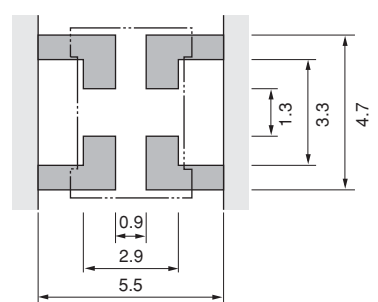

Series	a	b	c	d
DLW21S/H	0.8	2.6	0.4	1.2
DLW31SN	1.6	3.7	0.4	1.6
DLW43SH110/220/510	3.0	5.9	1.6	3.4
DLW43SH101	3.2	5.9	1.6	3.4

- \*1: If the pattern is made with wider than 1.2mm (DLW21) / 1.6mm (DLW31S) it may result in components turning around, because melting speed is different. In the worst case, short circuit between lines may occur.
- \*2: If the pattern is made with less than specified dimensions, in the worst case, short circuit between lines may occur due to spread of soldering paste or mount placing accuracy.
- \*3: If the pattern is made with wider than 0.8mm (DLW21) / 1.6mm (DLW31SN), the bending strength will be reduced. Do not use gild pattern; excess soldering heat may dissolve metal of a copper wire.

⚠Note • Please read rating and ⚠CAUTION (for storage, operating, rating, soldering, mounting and handling) in this catalog to prevent smoking and/or burning, etc.  
 • This catalog has only typical specifications. Therefore, please approve our product specifications or transact the approval sheet for product specifications before ordering.

Land Pattern + Solder Resist  
 Land Pattern  
 Solder Resist (in mm)

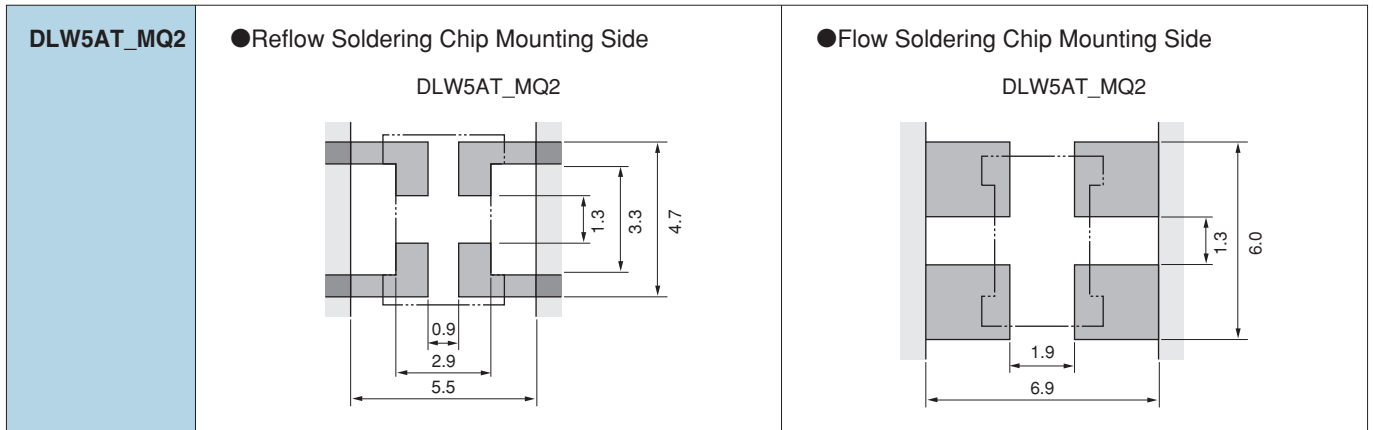

- PCB Warping  
PCB should be designed so that products are not subjected to the mechanical stress caused by warping the board.

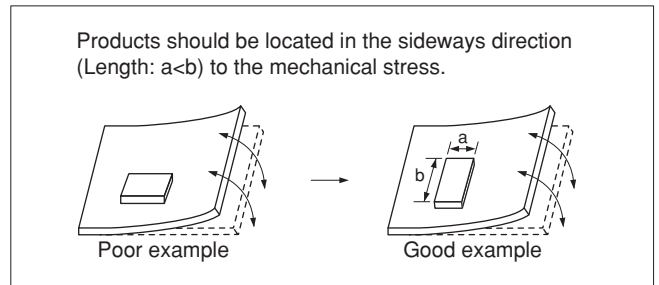

⚠Note • Please read rating and ⚠CAUTION (for storage, operating, rating, soldering, mounting and handling) in this catalog to prevent smoking and/or burning, etc.  
 • This catalog has only typical specifications. Therefore, please approve our product specifications or transact the approval sheet for product specifications before ordering.

Chip Ferrite Bead  
 Chip EMIFIL®  
 Soldering and Mounting  
 Chip Common Mode Choke Coil  
 Block Type EMIFIL®  
 Microwave Absorber



## 2. Solder Paste Printing and Adhesive Application

When reflow soldering the chip common mode choke coils, the printing must be conducted in accordance with the following cream solder printing conditions.

If too much solder is applied, the chip will be prone to damage by mechanical and thermal stress from the PCB and may crack.

Standard land dimensions should be used for resist and copper foil patterns.

When flow soldering the chip common mode choke coils, apply the adhesive in accordance with the following conditions.

If too much adhesive is applied, then it may overflow into the land or termination areas and yield poor solderability. In contrast, if insufficient adhesive is applied, or if the adhesive is not sufficiently hardened, then the chip may become detached during flow soldering process.

(in mm)

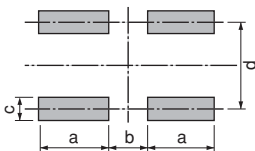
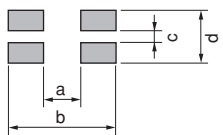
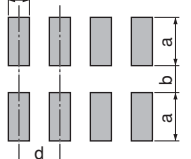
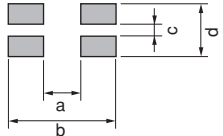
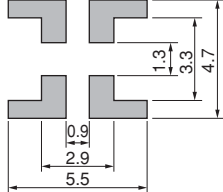
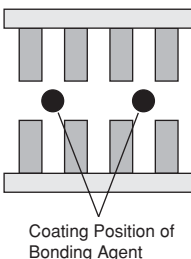
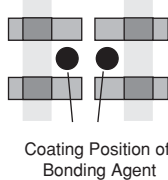
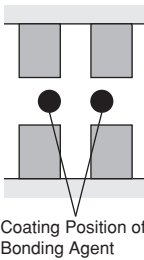
Series	Solder Paste Printing	Adhesive Application																																																																																	
<b>DLP</b> <b>DLW</b> <b>DLM</b>	<p>●Guideline of solder paste thickness:                      80-100μm: DLP0QS                      100-150μm: DLW21S/21H/31S, DLP0NS/11S/11R/11T/1ND/2AD/                      DLM11S/11G                      150μm: DLW43S                      150-200μm: DLP31D/31S, DLW5A/5B</p> <p>*Solderability is subject to reflow conditions and thermal conductivity.                      Please make sure that your product has been evaluated in view of your specifications with our product being mounted to your product.</p> <p>DLP0QS/0NS/11S/11R/11T/31S/DLM11S/11G</p>  <table border="1"> <thead> <tr> <th>Series</th> <th>a</th> <th>b</th> <th>c</th> <th>d</th> </tr> </thead> <tbody> <tr> <td><b>DLP0QS</b></td> <td>0.3</td> <td>0.2</td> <td>0.23</td> <td>0.48</td> </tr> <tr> <td><b>DLP0NS</b></td> <td>0.3</td> <td>0.3</td> <td>0.3</td> <td>0.5</td> </tr> <tr> <td><b>DLM11S/DLP11S</b></td> <td>0.7</td> <td>0.55</td> <td>0.3</td> <td>0.55</td> </tr> <tr> <td><b>DLP11R/T</b></td> <td>0.5</td> <td>0.55</td> <td>0.3</td> <td>0.55</td> </tr> <tr> <td><b>DLP31S</b></td> <td>1.0</td> <td>0.6</td> <td>0.7</td> <td>2.1</td> </tr> <tr> <td><b>DLM11G</b></td> <td>0.5</td> <td>0.5</td> <td>0.4</td> <td>0.7</td> </tr> </tbody> </table> <p>DLW21S/21H/31S</p>  <table border="1"> <thead> <tr> <th>Series</th> <th>a</th> <th>b</th> <th>c</th> <th>d</th> </tr> </thead> <tbody> <tr> <td><b>DLW21S/H</b></td> <td>0.8</td> <td>2.6</td> <td>0.5</td> <td>1.2</td> </tr> <tr> <td><b>DLW31S</b></td> <td>1.6</td> <td>3.7</td> <td>0.4</td> <td>1.6</td> </tr> </tbody> </table> <p>DLP1ND/2AD/31D</p>  <table border="1"> <thead> <tr> <th>Series</th> <th>a</th> <th>b</th> <th>c</th> <th>d</th> </tr> </thead> <tbody> <tr> <td><b>DLP1ND</b></td> <td>0.3</td> <td>0.3</td> <td>0.2</td> <td>0.4</td> </tr> <tr> <td><b>DLP2AD</b></td> <td>0.55</td> <td>0.4</td> <td>0.25</td> <td>0.5</td> </tr> <tr> <td><b>DLP31D</b></td> <td>1.0</td> <td>0.8</td> <td>0.4</td> <td>0.8</td> </tr> </tbody> </table> <p>DLW43S</p>  <table border="1"> <thead> <tr> <th>Series</th> <th>a</th> <th>b</th> <th>c</th> <th>d</th> </tr> </thead> <tbody> <tr> <td rowspan="2"><b>DLW43S</b></td> <td>3.0 (110/220/510)</td> <td rowspan="2">5.9</td> <td rowspan="2">1.6</td> <td rowspan="2">3.4</td> </tr> <tr> <td>3.2 (101)</td> </tr> </tbody> </table> <p>DLW5A/5B</p> 	Series	a	b	c	d	<b>DLP0QS</b>	0.3	0.2	0.23	0.48	<b>DLP0NS</b>	0.3	0.3	0.3	0.5	<b>DLM11S/DLP11S</b>	0.7	0.55	0.3	0.55	<b>DLP11R/T</b>	0.5	0.55	0.3	0.55	<b>DLP31S</b>	1.0	0.6	0.7	2.1	<b>DLM11G</b>	0.5	0.5	0.4	0.7	Series	a	b	c	d	<b>DLW21S/H</b>	0.8	2.6	0.5	1.2	<b>DLW31S</b>	1.6	3.7	0.4	1.6	Series	a	b	c	d	<b>DLP1ND</b>	0.3	0.3	0.2	0.4	<b>DLP2AD</b>	0.55	0.4	0.25	0.5	<b>DLP31D</b>	1.0	0.8	0.4	0.8	Series	a	b	c	d	<b>DLW43S</b>	3.0 (110/220/510)	5.9	1.6	3.4	3.2 (101)	<p>■ <b>DLP31S/DLP31D/</b>  <b>DLW5AT_MQ2</b>                      Apply 0.3mg of bonding agent at each chip.</p> <p><b>DLP31D</b></p>  <p>Coating Position of Bonding Agent</p> <p><b>DLP31S</b></p>  <p>Coating Position of Bonding Agent</p> <p><b>DLW5AT_MQ2</b></p>  <p>Coating Position of Bonding Agent</p>
	Series	a	b	c	d																																																																														
	<b>DLP0QS</b>	0.3	0.2	0.23	0.48																																																																														
	<b>DLP0NS</b>	0.3	0.3	0.3	0.5																																																																														
	<b>DLM11S/DLP11S</b>	0.7	0.55	0.3	0.55																																																																														
	<b>DLP11R/T</b>	0.5	0.55	0.3	0.55																																																																														
	<b>DLP31S</b>	1.0	0.6	0.7	2.1																																																																														
	<b>DLM11G</b>	0.5	0.5	0.4	0.7																																																																														
	Series	a	b	c	d																																																																														
	<b>DLW21S/H</b>	0.8	2.6	0.5	1.2																																																																														
<b>DLW31S</b>	1.6	3.7	0.4	1.6																																																																															
Series	a	b	c	d																																																																															
<b>DLP1ND</b>	0.3	0.3	0.2	0.4																																																																															
<b>DLP2AD</b>	0.55	0.4	0.25	0.5																																																																															
<b>DLP31D</b>	1.0	0.8	0.4	0.8																																																																															
Series	a	b	c	d																																																																															
<b>DLW43S</b>	3.0 (110/220/510)	5.9	1.6	3.4																																																																															
	3.2 (101)																																																																																		

△Note • Please read rating and △CAUTION (for storage, operating, rating, soldering, mounting and handling) in this catalog to prevent smoking and/or burning, etc.  
 • This catalog has only typical specifications. Therefore, please approve our product specifications or transact the approval sheet for product specifications before ordering.

**3. Standard Soldering Conditions**

**(1) Soldering Methods**

Use flow and reflow soldering methods only.  
 Use standard soldering conditions when soldering chip common mode choke coils.  
 In cases where several different parts are soldered, each having different soldering conditions, use those conditions requiring the least heat and minimum time.

**Solder:** Use Sn-3.0Ag-0.5Cu solder. Use of Sn-Zn based solder will deteriorate performance of products.  
 If using DLP/DLM series with Sn-Zn based solder, please contact Murata in advance.

**Flux:**

- Use Rosin-based flux.  
 In case of DLW21/31 series, use Rosin-based flux with converting chlorine content of 0.06 to 0.1wt%.  
 In case of using RA type solder, products should be cleaned completely with no residual flux.
- Do not use strong acidic flux (with chlorine content exceeding 0.20wt%)
- Do not use water-soluble flux.

For additional mounting methods, please contact Murata.

**(2) Soldering Profile**

● **Flow Soldering Profile**  
 (Sn-3.0Ag-0.5Cu Solder)

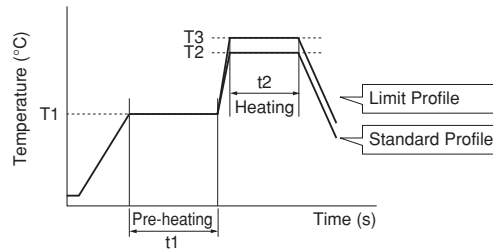

Series	Pre-heating		Standard Profile			Limit Profile		
	Temp. (T1)	Time. (t1)	Heating		Cycle of Flow	Heating		Cycle of Flow
			Temp. (T2)	Time. (t2)		Temp. (T3)	Time. (t2)	
<b>DLW5AT_MQ2</b> <b>DLP31D/31S</b>	150°C	60s min.	250°C	4 to 6s	2 times max.	265±3°C	5s max.	2 times max.

● **Reflow Soldering Profile**  
 (Sn-3.0Ag-0.5Cu Solder)

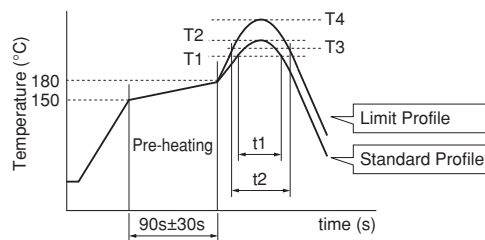

Series	Standard Profile				Limit Profile			
	Heating		Peak Temperature (T2)	Cycle of Reflow	Heating		Peak Temperature (T4)	Cycle of Reflow
	Temp. (T1)	Time. (t1)			Temp. (T3)	Time. (t2)		
<b>DLM/DLP</b> <b>DLW21/31</b>	220°C min.	30 to 60s	245±3°C	2 times max.	230°C min.	60s max.	260°C/10s	2 times max.
<b>DLW43S</b>	220°C min.	30 to 60s	245±3°C	2 times max.	240°C min.	30s max.	260°C/10s	2 times max.
<b>DLW5A/5B</b>	220°C min.	30 to 60s	250±3°C	2 times max.	230°C min.	60s max.	260°C/10s	2 times max.

△Note • Please read rating and △CAUTION (for storage, operating, rating, soldering, mounting and handling) in this catalog to prevent smoking and/or burning, etc.  
 • This catalog has only typical specifications. Therefore, please approve our product specifications or transact the approval sheet for product specifications before ordering.

Chip Ferrite Bead

Chip EMIFIL®

Soldering and Mounting  
 Chip Common Mode Choke Coil

Block Type EMIFIL®

Microwave Absorber

## (3) Reworking with Solder Iron

The following conditions must be strictly followed when using a soldering iron.

Pre-heating: 150°C 60s min.

Soldering iron power output / Tip diameter:

30W max. / ø3mm max.

Temperature of soldering iron tip / Soldering time / Times:

350°C max. / 3-4s / 2 times\*<sup>1</sup>

\*<sup>1</sup> DLP0QS, DLP0NS, DLP11S, DLP11T, DLP1ND,

DLP2AD: 380°C max. / 3-4s / 2 times

DLW43S: 350°C max. / 3s / 2 times

Do not allow the tip of the soldering iron to directly contact the chip.

For additional methods of reworking with a soldering iron, please contact Murata engineering.

#### 4. Cleaning

Following conditions should be observed when cleaning chip EMI filter.

(1) Cleaning Temperature: 60°C max. (40°C max. for alcohol type cleaner)

(2) Ultrasonic

Output: 20W/liter max.

Duration: 5 minutes max.

Frequency: 28 to 40kHz

(3) Cleaning agent

The following list of cleaning agents have been tested on the individual components. Evaluation of final assembly should be completed prior to production.

Do not clean DLW (Except for DLW21H) series.

Before cleaning, please contact Murata engineering.

(a) Alcohol cleaning agent

Isopropyl alcohol (IPA)

(b) Aqueous cleaning agent

Pine Alpha ST-100S

(4) Ensure that flux residue is completely removed.

Component should be thoroughly dried after aqueous agent has been removed with deionized water.

⚠Note • Please read rating and ⚠CAUTION (for storage, operating, rating, soldering, mounting and handling) in this catalog to prevent smoking and/or burning, etc.  
• This catalog has only typical specifications. Therefore, please approve our product specifications or transact the approval sheet for product specifications before ordering.

### 1. Standard Land Pattern Dimensions

(in mm)

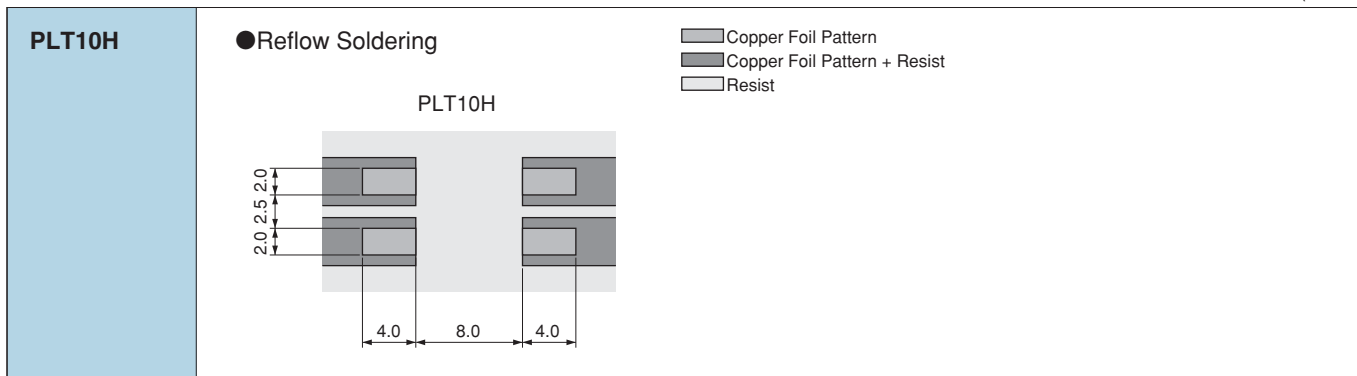

● PCB Warping

PCB should be designed so that products are not subjected to the mechanical stress caused by warping the board.

Products should be located in the sideways direction (Length: a<b) to the mechanical stress.

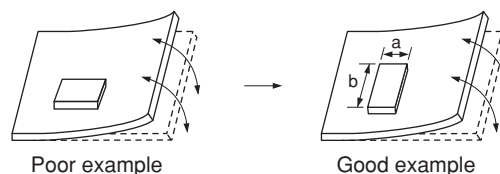

### 2. Solder Paste Printing and Adhesive Application

When reflow soldering the chip common mode choke coils, the printing must be conducted in accordance with the following cream solder printing conditions.

If too much solder is applied, the chip will be prone to damage by mechanical and thermal stress from the PCB and may crack.

Standard land dimensions should be used for resist and copper foil patterns.

When flow soldering the chip common mode choke coils, apply the adhesive in accordance with the following conditions.

If too much adhesive is applied, then it may overflow into the land or termination areas and yield poor solderability. In contrast, if insufficient adhesive is applied, or if the adhesive is not sufficiently hardened, then the chip may become detached during flow soldering process.

Series	Solder Paste Printing
<b>PLT10H</b>	<p>● Guideline of solder paste thickness: 150-200<math>\mu</math>m: PLT10H For the solder paste printing pattern, use standard land dimensions.</p> <p>*Solderability is subject to reflow conditions and thermal conductivity. Please make sure that your product has been evaluated in view of your specifications with our product being mounted to your product.</p>

△Note • Please read rating and △CAUTION (for storage, operating, rating, soldering, mounting and handling) in this catalog to prevent smoking and/or burning, etc.  
• This catalog has only typical specifications. Therefore, please approve our product specifications or transact the approval sheet for product specifications before ordering.

**3. Standard Soldering Conditions**

(1) Soldering Methods

Use reflow soldering methods only.  
 Use standard soldering conditions when soldering chip common mode choke coils.  
 In cases where several different parts are soldered, each having different soldering conditions, use those conditions requiring the least heat and minimum time.

Solder: Use Sn-3.0Ag-0.5Cu solder. Use of Sn-Zn based solder will deteriorate performance of products.

Flux:

- Use Rosin-based flux.
- Do not use strong acidic flux (with chlorine content exceeding 0.20wt%)
- Do not use water-soluble flux.

For additional mounting methods, please contact Murata.

(2) Soldering Profile

● Reflow Soldering Profile  
 (Sn-3.0Ag-0.5Cu Solder)

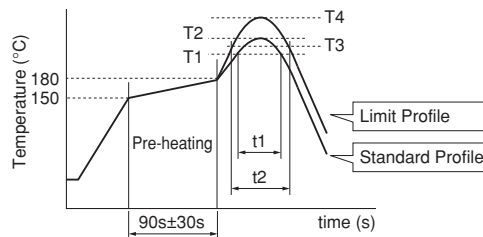

Series	Standard Profile				Limit Profile			
	Heating		Peak Temperature (T2)	Cycle of Reflow	Heating		Peak Temperature (T4)	Cycle of Reflow
	Temp. (T1)	Time. (t1)			Temp. (T3)	Time. (t2)		
<b>PLT10H</b>	220°C min.	30 to 60s	250±3°C	2 times max.	230°C min.	60s max.	260°C/10s	2 times max.

(3) Reworking with Solder Iron

The following conditions must be strictly followed when using a soldering iron.  
 Pre-heating: 150°C 60s min.  
 Soldering iron power output / Tip diameter:  
 80W max. / ø3mm max.  
 Temperature of soldering iron tip / Soldering time / Times:  
 400°C max. / 5s / 2 times

Do not allow the tip of the soldering iron to directly contact the chip.  
 For additional methods of reworking with a soldering iron, please contact Murata engineering.

**4. Cleaning**

Do not clean after soldering. If cleaning, please contact us.

△Note • Please read rating and △CAUTION (for storage, operating, rating, soldering, mounting and handling) in this catalog to prevent smoking and/or burning, etc.  
 • This catalog has only typical specifications. Therefore, please approve our product specifications or transact the approval sheet for product specifications before ordering.

## ■ Minimum Quantity and Dimensions of 8mm Width Paper / Embossed Tape

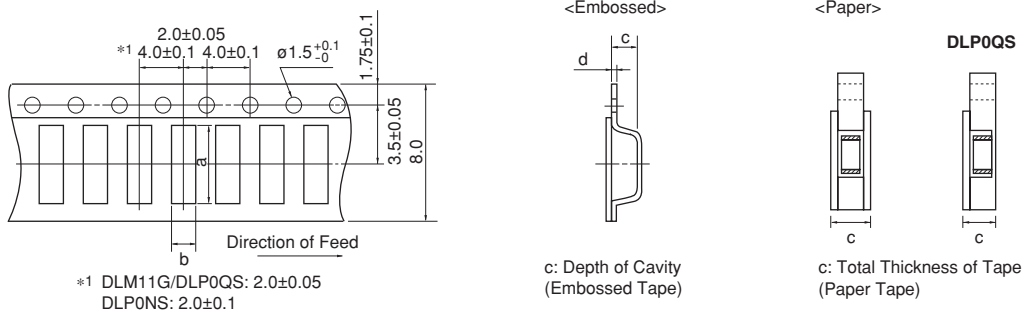

Dimension of the cavity of embossed tape is measured at the bottom side.

Part Number	Dimensions				Minimum Qty. (pcs.)				Bulk
					ø180mm Reel		ø330mm Reel		
	a	b	c	d	Paper Tape	Embossed Tape	Paper Tape	Embossed Tape	
DLM11G	1.45	1.2	0.8 max.	-	10000	-	-	-	1000
DLM11S	1.4	1.15	0.65	0.25	-	4000	-	-	500
DLP0QS	0.73	0.6	0.55 max.	-	15000	-	-	-	500
DLP0NS	0.95	0.75	0.55	0.25	-	10000	-	-	500
DLP11S	1.4	1.2	0.98	0.25	-	3000	-	-	500
DLP11R	1.4	1.15	0.7	0.25	-	4000	-	-	500
DLP11T	1.35	1.1	0.45	0.25	-	5000	-	-	500
DLP1ND	1.7	0.84	0.57	0.25	-	5000	-	-	500
DLP2AD	2.2	1.2	0.98	0.25	-	3000	-	-	500
DLP31D/31S	3.5	1.9	1.3	0.25	-	3000	-	-	500
DLW21S	2.25	1.45	1.4	0.3	-	2000	-	-	500
DLW21H	2.3	1.55	1.1	0.25	-	3000	-	-	500
DLW31S	3.6	2.0	2.1	0.3	-	2000	-	-	500

(in mm)

## ■ Minimum Quantity and Dimensions of 12mm Width Embossed Tape

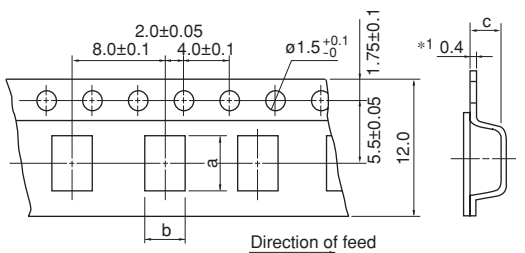

Dimension of the cavity is measured at the bottom side.

Part Number	Dimensions			Minimum Qty. (pcs.)		
	a	b	c	ø180mm Reel	ø330mm Reel	Bulk
DLW43SH_XK	4.9	3.6	2.7	500	2500	100
DLW43SH_XP	4.9	3.6	2.9	500	2500	100
DLW5AH	5.4	4.1	4.4	400	1500	100
DLW5AT	5.4	4.1	2.7	700	2500	100
DLW5BS	5.5	5.4	4.7	400	1500	100
DLW5BT	5.5	5.5	2.7	700	2500	100

(in mm)

"Minimum Quantity" means the number of units of each delivery or order. The quantity should be an integral multiple of the "Minimum Quantity."

⚠Note • Please read rating and ⚠CAUTION (for storage, operating, rating, soldering, mounting and handling) in this catalog to prevent smoking and/or burning, etc.  
• This catalog has only typical specifications. Therefore, please approve our product specifications or transact the approval sheet for product specifications before ordering.



### Minimum Quantity and Dimensions of 24mm Width Embossed Tape

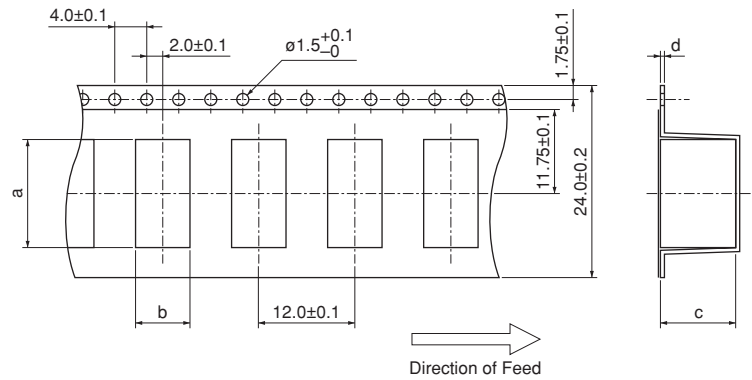

Dimension of the cavity is measured at the bottom side.

Part Number	Dimensions				Minimum Qty. (pcs.)		
	a	b	c	d	ø180mm Reel	ø330mm Reel	Bulk
PLT10H	13.5	6.8	9.4	0.5	125	500	50

(in mm)

⚠Note • Please read rating and ⚠CAUTION (for storage, operating, rating, soldering, mounting and handling) in this catalog to prevent smoking and/or burning, etc.  
• This catalog has only typical specifications. Therefore, please approve our product specifications or transact the approval sheet for product specifications before ordering.



### ●EKEMDL21AQ-KIT (Chip Common Mode Choke Coils)

No.	Part Number	Quantity (pcs.)	Common Mode Impedance (at 100MHz, 20 degrees C)	Rated Voltage (Vdc)	Rated Current (mA)
1	DLW21HN670SQ2	10	67Ω±25%	50	330
2	DLW21HN900SQ2	10	90Ω±25%	50	330
3	DLW21HN121SQ2	10	120Ω±25%	50	280
4	DLW21HN181SQ2	10	180Ω±25%	50	250
5	DLW21HN670HQ2	10	67Ω±25%	20	240
6	DLW21HN900HQ2	10	90Ω±25%	20	220
7	DLW21HN121HQ2	10	120Ω±25%	20	200
8	DLW21SN501SK2	10	500Ω±25%	50	250
9	DLW21SN670SQ2	10	67Ω±25%	50	400
10	DLW21SN900SQ2	10	90Ω±25%	50	330
11	DLW21SN121SQ2	10	120Ω±25%	50	370
12	DLW21SN181SQ2	10	180Ω±25%	50	330
13	DLW21SN261SQ2	10	260Ω±25%	50	300
14	DLW21SN371SQ2	10	370Ω±25%	50	280
15	DLW21SN670HQ2	10	67Ω±25%	20	320
16	DLW21SN900HQ2	10	90Ω±25%	20	280
17	DLW21SN121HQ2	10	120Ω±25%	20	280
18	DLW21SR670HQ2	10	67Ω±25%	20	400
19	DLW21SN181XQ2	10	180Ω±25%	20	240
20	DLW21SN261XQ2	10	260Ω±25%	20	220
21	DLW21SN491XQ2	10	490Ω±25%	20	190
22	DLP0NSC280HL2	10	28Ω±20%	5	100
23	DLP0NSN350HL2	10	35Ω±10Ω	5	100
24	DLP0NSN670HL2	10	67Ω±20%	5	110
25	DLP0NSN900HL2	10	90Ω±20%	5	100
26	DLP0NSN121HL2	10	120Ω±20%	5	90
27	DLP0NSA070HL2	10	7Ω±2Ω	5	100
28	DLP0NSA150HL2	10	15Ω±5Ω	5	100
29	DLP0QSN600HL2	10	60Ω±25%	5	50
30	DLP0QSA070HL2	10	7Ω±2Ω	5	100
31	DLP0QSA150HL2	10	15Ω±5Ω	5	100
32	DLP0QSA350HL2	10	35Ω±10Ω	5	100
33	DLP1NDN350HL4	10	35Ω±20%	5	100
34	DLP1NDN670HL4	10	67Ω±20%	5	80
35	DLP1NDN900HL4	10	90Ω±20%	5	60
36	DLP11SA350HL2	10	35Ω±20%	5	170
37	DLP11SA670HL2	10	67Ω±20%	5	150
38	DLP11SA900HL2	10	90Ω±20%	5	150
39	DLP11SN670SL2	10	67Ω±20%	5	180
40	DLP11SN121SL2	10	120Ω±20%	5	140
41	DLP11SN161SL2	10	160Ω±20%	5	120
42	DLP11SN900HL2	10	90Ω±20%	5	150
43	DLP11SN201HL2	10	200Ω±20%	5	110
44	DLP11SN241HL2	10	240Ω±20%	5	100
45	DLP11SN281HL2	10	280Ω±20%	5	90
46	DLP11SN331HL2	10	330Ω±20%	5	80
47	DLP11RB150UL2	10	15Ω±5Ω	5	100
48	DLP11RB400UL2	10	40Ω±10Ω	5	100
49	DLP11RN450UL2	10	45Ω±25%	5	100
50	DLP11TB800UL2	10	80Ω±25%	5	100
51	DLP2ADA350HL4	10	35Ω±20%	5	150
52	DLP2ADA670HL4	10	67Ω±20%	5	130
53	DLP2ADA900HL4	10	90Ω±20%	5	120
54	DLP2ADN670HL4	10	67Ω±20%	5	140
55	DLP2ADN900HL4	10	90Ω±20%	5	130

Continued on the following page.

△Note • Please read rating and △CAUTION (for storage, operating, rating, soldering, mounting and handling) in this catalog to prevent smoking and/or burning, etc.  
 • This catalog has only typical specifications. Therefore, please approve our product specifications or transact the approval sheet for product specifications before ordering.



Continued from the preceding page.

No.	Part Number	Quantity (pcs.)	Common Mode Impedance (at 100MHz, 20 degrees C)	Rated Voltage (Vdc)	Rated Current (mA)
56	DLP2ADN121HL4	10	120Ω±20%	5	120
57	DLP2ADN161HL4	10	160Ω±20%	5	100
58	DLP2ADN201HL4	10	200Ω±20%	5	90
59	DLP2ADN241HL4	10	240Ω±20%	5	80
60	DLP2ADN281HL4	10	280Ω±20%	5	80
61	DLM11SN450HY2	10	45Ω±25%	5	100
62	DLM11SN900HY2	10	90Ω±25%	5	100

● EKEMDCC5AF-KIT (Chip Common Mode Choke Coils for DC Power Lines / SMD Block Type EMIFIL® for Power Lines)

No.	Part Number	Quantity (pcs.)	Common Mode Impedance (at 100MHz, 20 degrees C)	Rated Voltage (Vdc)	Rated Current (mA)
1	DLW5AHN402SQ2	5	4000Ω (Typ.)	50	200
2	DLW5ATN111SQ2	5	110Ω (Typ.)	50	5000
3	DLW5ATN401SQ2	5	400Ω (Typ.)	50	2000
4	DLW5ATN501SQ2	5	500Ω (Typ.)	50	1500
5	DLW5ATN851SQ2	5	850Ω (Typ.)	50	1500
6	DLW5ATN272SQ2	5	2700Ω (Typ.)	50	1000
7	DLW5BSM501TQ2	5	500Ω (Typ.)	50	1000
8	DLW5BSM601TQ2	5	600Ω (Typ.)	50	1400
9	DLW5BSM801TQ2	5	800Ω (Typ.)	50	2000
10	DLW5BSM191SQ2	5	190Ω (Typ.)	50	5000
11	DLW5BSM351SQ2	5	350Ω (Typ.)	50	2000
12	DLW5BSM102SQ2	5	1000Ω (Typ.)	50	1500
13	DLW5BSM152SQ2	5	1500Ω (Typ.)	50	1000
14	DLW5BSM302SQ2	5	3000Ω (Typ.)	50	500
15	DLW5BTM101SQ2	5	100Ω (Typ.)	50	6000
16	DLW5BTM251SQ2	5	250Ω (Typ.)	50	5000
17	DLW5BTM501SQ2	5	500Ω (Typ.)	50	4000
18	DLW5BTM102SQ2	5	1000Ω (Typ.)	50	2000
19	DLW5BTM142SQ2	5	1400Ω (Typ.)	50	1500

● EKEMDL5AAC-KIT (Chip Common Mode Choke Coils for DC Power Lines / SMD Block Type EMIFIL® for Power Lines / 105 degree C available Type)

No.	Part Number	Quantity (pcs.)	Common Mode Impedance (at 100MHz, 20 degrees C)	Rated Voltage (Vdc)	Rated Current (mA)
1	DLW5ATN500MQ2	5	50Ω (Typ.)	50	6000
2	DLW5ATN151MQ2	5	150Ω (Typ.)	50	5000
3	DLW5ATN331MQ2	5	330Ω (Typ.)	50	4000
4	DLW5ATN501MQ2	5	500Ω (Typ.)	50	2500
5	DLW5ATN112MQ2	5	1100Ω (Typ.)	50	2000
6	DLW5ATN111TQ2	5	110Ω (Typ.)	50	5000
7	DLW5ATN231TQ2	5	230Ω (Typ.)	50	4000
8	DLW5ATN401TQ2	5	400Ω (Typ.)	50	2500
9	DLW5ATN501TQ2	5	500Ω (Typ.)	50	2000
10	DLW5BTM101TQ2	5	100Ω (Typ.)	50	6000
11	DLW5BTM251TQ2	5	250Ω (Typ.)	50	5000
12	DLW5BTM501TQ2	5	500Ω (Typ.)	50	4000
13	DLW5BTM102TQ2	5	1000Ω (Typ.)	50	2500
14	DLW5BTM142TQ2	5	1400Ω (Typ.)	50	2000
15	DLW5BSM501TQ2	5	500Ω (Typ.)	50	1000
16	DLW5BSM601TQ2	5	600Ω (Typ.)	50	1400
17	DLW5BSM801TQ2	5	800Ω (Typ.)	50	2000

△Note • Please read rating and △CAUTION (for storage, operating, rating, soldering, mounting and handling) in this catalog to prevent smoking and/or burning, etc.  
• This catalog has only typical specifications. Therefore, please approve our product specifications or transact the approval sheet for product specifications before ordering.



#### ●EKEPBLCKAD-KIT

No.	Part Number	Quantity (pcs.)	Common Mode Impedance (at 10MHz, 20 degrees C)	Rated Voltage (Vdc)	Rated Current (A)
1	PLT10HH450180PN	2	45Ω (Typ.)	300	18
2	PLT10HH101150PN	2	100Ω (Typ.)	300	15
3	PLT10HH401100PN	2	400Ω (Typ.)	100	10
4	PLT10HH501100PN	2	500Ω (Typ.)	100	10
5	PLT10HH9016R0PN	2	900Ω (Typ.)	100	6
6	PLT10HH1026R0PN	2	1000Ω (Typ.)	100	6

No.	Part Number	Quantity (pcs.)	Insertion Loss	Rated Voltage (Vdc)	Rated Current (A)
7	BNX002-01	1	1MHz to 1GHz : 40dB min.	50	10
8	BNX003-01	1	5MHz to 1GHz : 40dB min.	150	10
9	BNX005-01	1	1MHz to 1GHz : 40dB min.	50	15
10	BNX012-01	1	1MHz to 1GHz : 40dB min.	50	15
11	BNX016-01	1	100kHz to 1GHz : 40dB min.	25	15
12	BNX022-01	2	1MHz to 1GHz : 35dB min.	50	10
13	BNX023-01	2	1MHz to 1GHz : 35dB min.	100	15
14	BNX024H01	2	100kHz to 1GHz : 35dB min.	50	15
15	BNX025H01	2	50kHz to 1GHz : 35dB min.	25	15

△Note • Please read rating and △CAUTION (for storage, operating, rating, soldering, mounting and handling) in this catalog to prevent smoking and/or burning, etc.  
 • This catalog has only typical specifications. Therefore, please approve our product specifications or transact the approval sheet for product specifications before ordering.

# BNX

## Block Type EMIFIL®

Series Line Up .....	218
Function Example .....	218
Product Detail .....	221
⚠Caution/Notice .....	225
Soldering and Mounting .....	227
Packaging .....	231
Design Kits .....	232

Chip Ferrite Bead

Chip EMIFIL®

Chip Common Mode Choke Coil

Block Type EMIFIL®

Microwave Absorber

⚠Note • Please read rating and ⚠CAUTION (for storage, operating, rating, soldering, mounting and handling) in this catalog to prevent smoking and/or burning, etc.  
• This catalog has only typical specifications. Therefore, please approve our product specifications or transact the approval sheet for product specifications before ordering.

Type	Part Number	Thickness (mm)	Rated Voltage	Effective Frequency Range	Rated Current	Kit	≥3A	Flow	R <sub>efflow</sub>
SMD Type for Power Lines <i>p221</i>	BNX022-01	3.1	50Vdc	1MHz to 1GHz:35dB min.	10A	Kit	≥3A		R <sub>efflow</sub>
	BNX023-01	3.1	100Vdc	1MHz to 1GHz:35dB min.	15A	Kit	≥3A		R <sub>efflow</sub>
	BNX024H01	3.5	50Vdc	100kHz to 1GHz:35dB min.	15A	Kit	≥3A		R <sub>efflow</sub>
	BNX025H01	3.5	25Vdc	50kHz to 1GHz:35dB min.	15A	Kit	≥3A		R <sub>efflow</sub>
Lead Type for Power Lines <i>p223</i>	BNX002-01	18.0	50Vdc	1MHz to 1GHz:40dB min.	10A	Kit	≥3A	Flow	
	BNX003-01	18.0	150Vdc	5MHz to 1GHz:40dB min.	10A	Kit	≥3A	Flow	
	BNX005-01	18.5	50Vdc	1MHz to 1GHz:40dB min.	15A	Kit	≥3A	Flow	
Lead Type Low Profile for Power Lines <i>p224</i>	BNX012-01	8.0	50Vdc	1MHz to 1GHz:40dB min.	15A	Kit	≥3A	Flow	
	BNX016-01	8.0	25Vdc	100kHz to 1GHz:40dB min.	15A	Kit	≥3A	Flow	

## Suppression of Radiation Noise from Power Line Cable

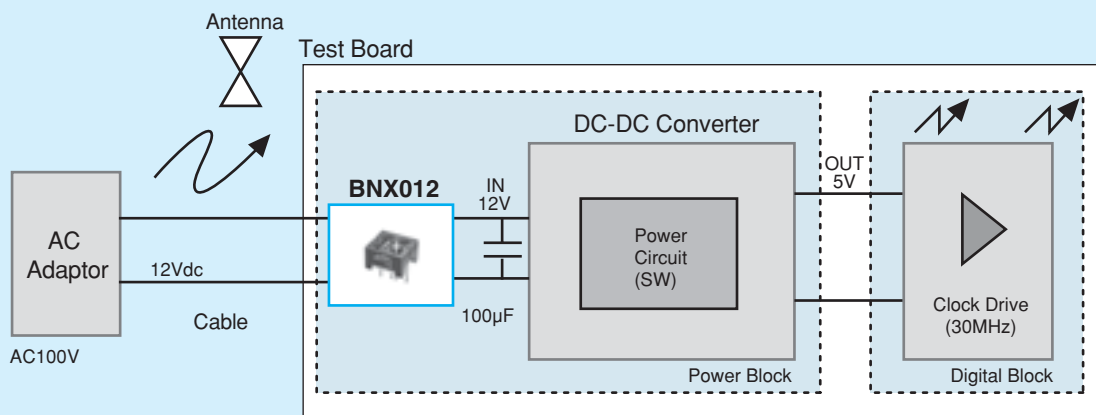

### Test Result

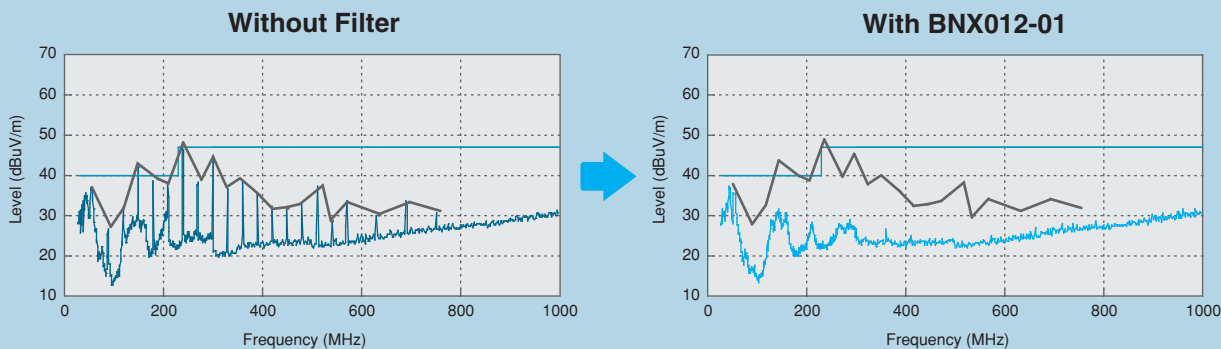

△Note • Please read rating and △CAUTION (for storage, operating, rating, soldering, mounting and handling) in this catalog to prevent smoking and/or burning, etc.  
• This catalog has only typical specifications. Therefore, please approve our product specifications or transact the approval sheet for product specifications before ordering.

### Impulse Noise Countermeasure

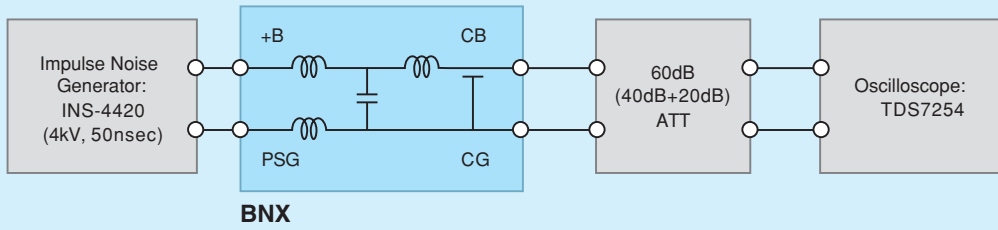

#### Without Filter

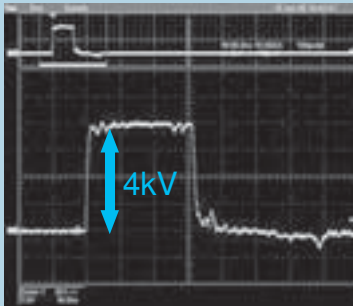

Applied Impulse Voltage: 4kV/50nS  
Y-AXIS: 1kV/div

#### With Filter



BNX002-01



BNX012-01

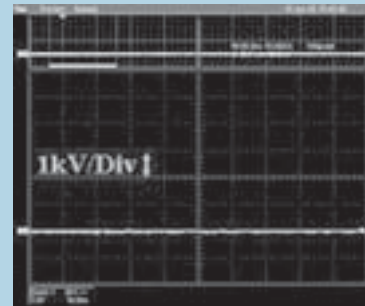

BNX022-01

### ESD Countermeasure

ESD Waveform Comparison

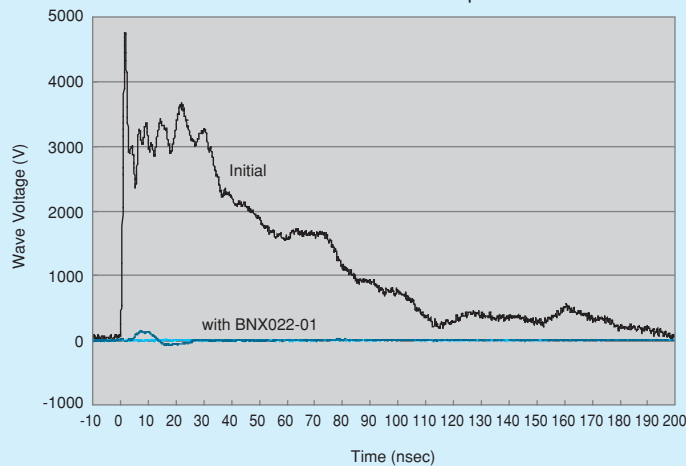

**Note** • Please read rating and **CAUTION** (for storage, operating, rating, soldering, mounting and handling) in this catalog to prevent smoking and/or burning, etc.  
• This catalog has only typical specifications. Therefore, please approve our product specifications or transact the approval sheet for product specifications before ordering.

## Suppression of Ripple Noise of DC Side in the Switching Power Supply

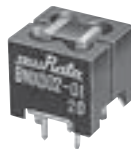

Test Circuit

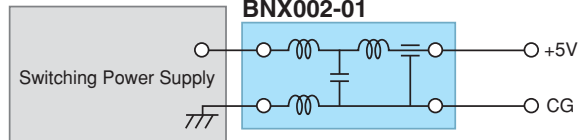

Type of Filter	EMI Suppression Effect / Description	
Without Filter	<p>+5.0V→ 50μs/div 0.2V/div</p>	There is high frequency noise of 0.5V maximum.
When BNX002-01 is used	<p>+5.0V→ 50μs/div 0.2V/div</p>	BNX002-01 can suppress most of the noise.

## Example of Impulse Noise Suppression

Type of Filter	EMI Suppression Effect	
Without Filter	<p>Impulse Noise 2000V/50ns</p> <p>Y-axis: 500V/div X-axis: 10ns/sec</p>	
When BNX002 is used	<p>Y-axis: 500V/div X-axis: 10ns/sec</p>	

△Note • Please read rating and △CAUTION (for storage, operating, rating, soldering, mounting and handling) in this catalog to prevent smoking and/or burning, etc.  
• This catalog has only typical specifications. Therefore, please approve our product specifications or transact the approval sheet for product specifications before ordering.

# BNX02□ Series



## SMD package of block type EMIFIL®.

**BNX022/BNX023**



**■ Dimensions**

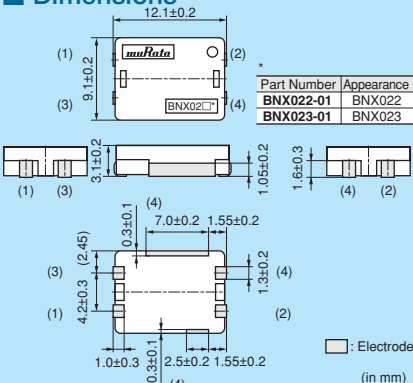

Part Number | Appearance  
**BNX022-01** | BNX022  
**BNX023-01** | BNX023

□: Electrode (in mm)

**■ Equivalent Circuit**

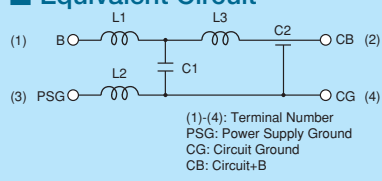

(1)-(4): Terminal Number  
 PSG: Power Supply Ground  
 CG: Circuit Ground  
 CB: Circuit+B

**■ Packaging**

Code	Packaging	Minimum Quantity
L	180mm Reel Embossed Tape	400
K	330mm Reel Embossed Tape	1500
B	Bulk(Bag)	100

**BNX024H/BNX025H**



**■ Dimensions**

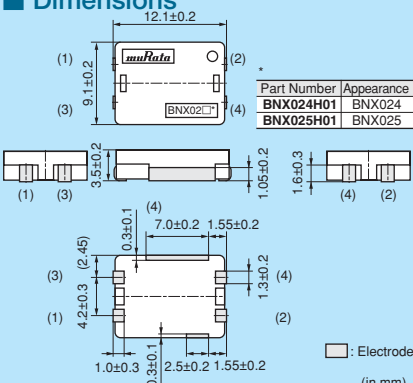

Part Number | Appearance  
**BNX024H01** | BNX024  
**BNX025H01** | BNX025

□: Electrode (in mm)

**■ Equivalent Circuit**

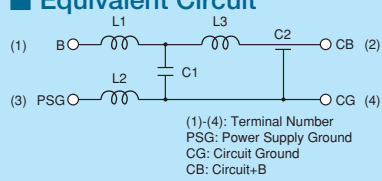

(1)-(4): Terminal Number  
 PSG: Power Supply Ground  
 CG: Circuit Ground  
 CB: Circuit+B

**■ Packaging**

Code	Packaging	Minimum Quantity
L	180mm Reel Embossed Tape	400
K	330mm Reel Embossed Tape	1500
B	Bulk(Bag)	100

Refer to pages from p.227 to p.228 for mounting information.

**■ Rated Value** (□: packaging code)

Part Number	Rated Voltage	Withstand Voltage	Rated Current	Insulation Resistance (min.)	Insertion Loss (Line impedance=50 ohm)	Kit
<b>BNX022-01</b> □	50Vdc	125Vdc	10A	500M ohm	1MHz to 1GHz:35dB min.	Kit ≥3A
<b>BNX023-01</b> □	100Vdc	250Vdc	15A	500M ohm	1MHz to 1GHz:35dB min.	Kit ≥3A
<b>BNX024H01</b> □	50Vdc	125Vdc	15A	100M ohm	100kHz to 1GHz:35dB min.	Kit ≥3A
<b>BNX025H01</b> □	25Vdc	62.5Vdc	15A	50M ohm	50kHz to 1GHz:35dB min.	Kit ≥3A

Operating Temperature Range: -40°C to +125°C (BNX022/BNX023), -55°C to +125°C (BNX024H/BNX025H)

**■ Insertion Loss Characteristics**

**BNX022/023**

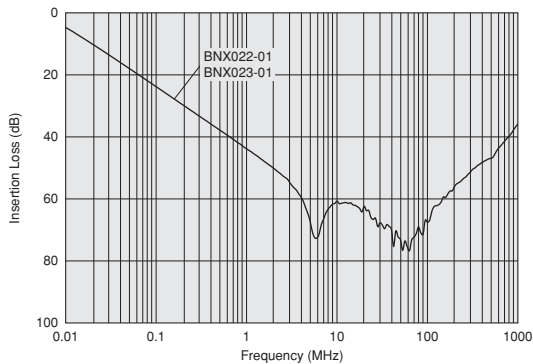

**BNX024H01**

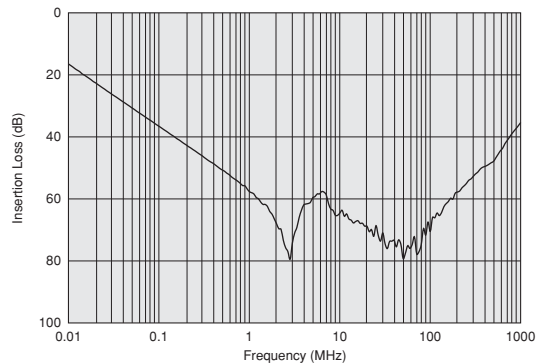

Continued on the following page. ↗

⚠Note • Please read rating and ⚠CAUTION (for storage, operating, rating, soldering, mounting and handling) in this catalog to prevent smoking and/or burning, etc.  
 • This catalog has only typical specifications. Therefore, please approve our product specifications or transact the approval sheet for product specifications before ordering.

**■ Insertion Loss Characteristics**  
BNX025H01

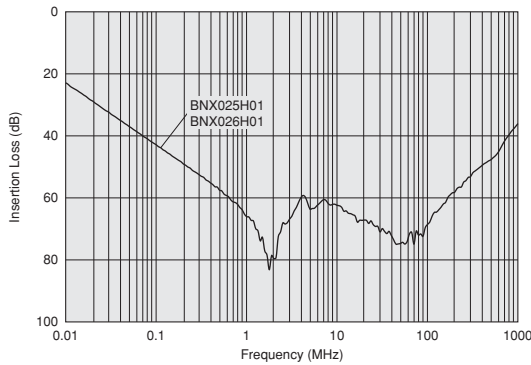

**■ Notice (Rating)**

In operating temperature exceeding +85°C, derating of current is necessary for BNX022 series. Please apply the derating curve shown in chart according to the operating temperature.

In operating temperature exceeding +85°C, derating of current is necessary for BNX023 series. Please apply the derating curve shown in chart according to the operating temperature.

Derating of Rated Current

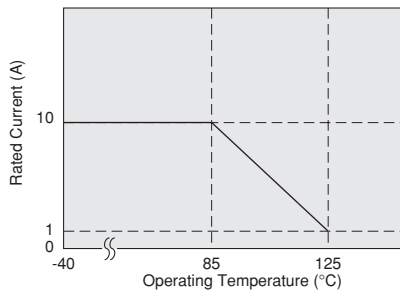

Derating of Rated Current

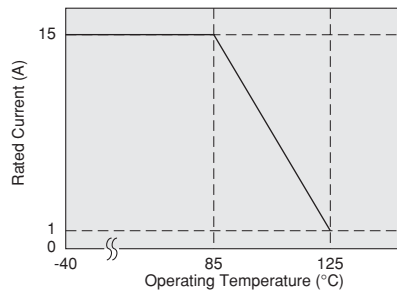

In operating temperature exceeding +85°C, derating of current is necessary for BNX024H/025H series. Please apply the derating curve shown in chart according to the operating temperature.

Derating of Rated Current

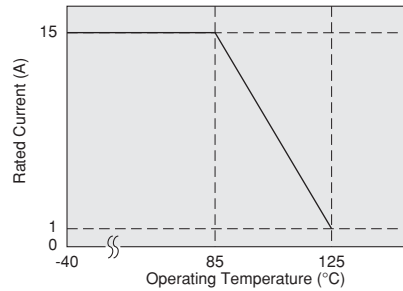

⚠Note • Please read rating and ⚠CAUTION (for storage, operating, rating, soldering, mounting and handling) in this catalog to prevent smoking and/or burning, etc.  
• This catalog has only typical specifications. Therefore, please approve our product specifications or transact the approval sheet for product specifications before ordering.

Chip Ferrite Bead  
Chip EMIFIL®  
Chip Common Mode Choke Coil  
Block Type EMIFIL® Power Lines Type  
Microwave Absorber



# BNX00□ Series



Large insertion loss from several hundred kHz to several GHz.

### BNX002/BNX003



#### ■ Dimensions

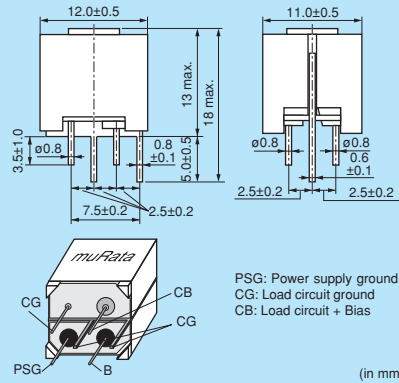

#### ■ Equivalent Circuit

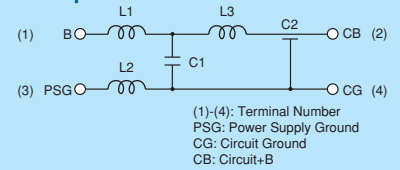

#### ■ Packaging

Code	Packaging	Minimum Quantity
-	Box	100

### BNX005



#### ■ Dimensions

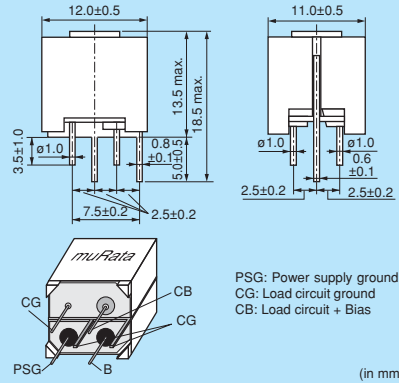

#### ■ Equivalent Circuit

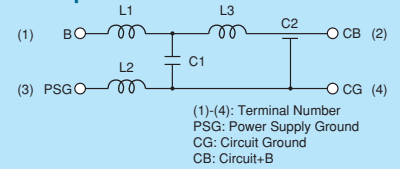

#### ■ Packaging

Code	Packaging	Minimum Quantity
-	Box	100

Refer to pages from p.229 to p.230 for mounting information.

#### ■ Rated Value

Part Number	Rated Voltage	Withstand Voltage	Rated Current	Insulation Resistance (min.)	Insertion Loss (Line impedance=50 ohm)	Kit
BNX002-01	50Vdc	125Vdc	10A	100M ohm	1MHz to 1GHz:40dB min.	Kit $\geq 3A$
BNX003-01	150Vdc	375Vdc	10A	100M ohm	5MHz to 1GHz:40dB min.	Kit $\geq 3A$
BNX005-01	50Vdc	125Vdc	15A	100M ohm	1MHz to 1GHz:40dB min.	Kit $\geq 3A$

Operating Temperature Range: -30°C to +85°C

#### ■ Insertion Loss Characteristics

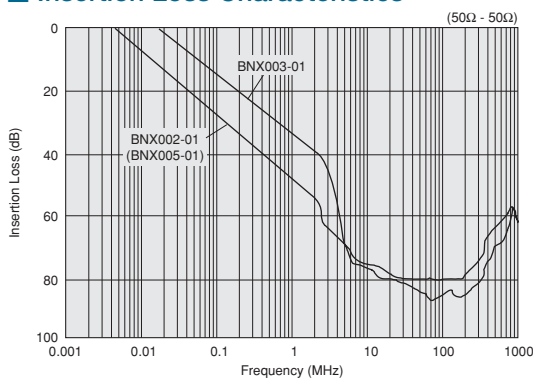

△Note • Please read rating and △CAUTION (for storage, operating, rating, soldering, mounting and handling) in this catalog to prevent smoking and/or burning, etc.  
• This catalog has only typical specifications. Therefore, please approve our product specifications or transact the approval sheet for product specifications before ordering.

# BNX01□ Series



Low profile version of BNX series.



### ■ Dimensions

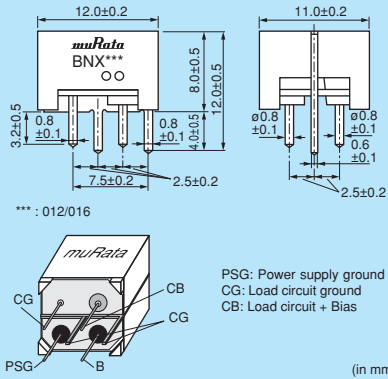

### ■ Equivalent Circuit

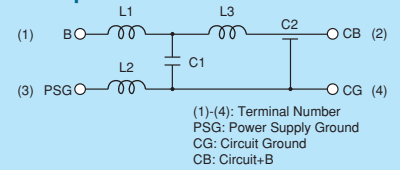

### ■ Packaging

Code	Packaging	Minimum Quantity
-	Box	150

Refer to pages from p.229 to p.230 for mounting information.

### ■ Rated Value

Part Number	Rated Voltage	Withstand Voltage	Rated Current	Insulation Resistance (min.)	Insertion Loss (Line impedance=50 ohm)	
BNX012-01	50Vdc	125Vdc	15A	500M ohm	1MHz to 1GHz:40dB min.	Kit ≥3A
BNX016-01	25Vdc	62.5Vdc	15A	50M ohm	100kHz to 1GHz:40dB min.	Kit ≥3A

Operating Temperature Range: -40°C to +125°C

### ■ Insertion Loss Characteristics

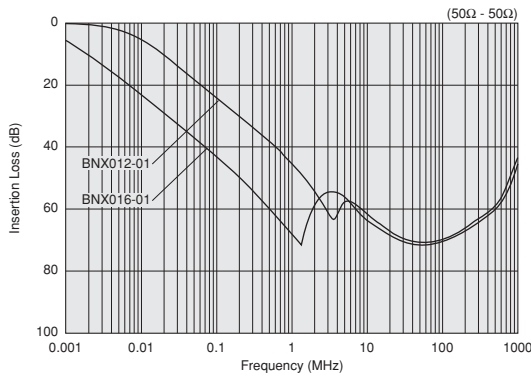

### ■ Notice (Rating)

In operating temperature exceeding +85°C, derating of current is necessary for BNX01□ series. Please apply the derating curve shown in chart according to the operating temperature.

#### Derating of Rated Current

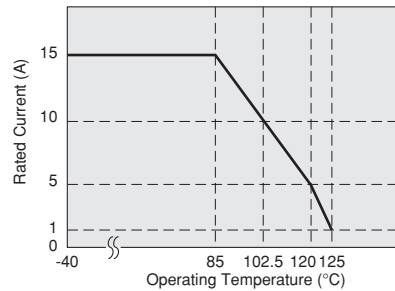

#### ● Connecting ± power line

In case of using ± power line, please connect to each terminal as shown.

	Power Supply (BNX Input)	BNX	Circuit (BNX Output)
Power Supply +Bias	B	CB	- Load Circuit +Bias
Power Supply Ground	PSG	CG	- Load Circuit Ground
Power Supply -Bias	B	CB	- Load Circuit -Bias
Power Supply Ground	PSG	CG	- Load Circuit Ground

△Note • Please read rating and △CAUTION (for storage, operating, rating, soldering, mounting and handling) in this catalog to prevent smoking and/or burning, etc.  
• This catalog has only typical specifications. Therefore, please approve our product specifications or transact the approval sheet for product specifications before ordering.

Chip Ferrite Bead  
Chip EMIFIL®  
Chip Common Mode Choke Coil  
Block Type EMIFIL® Power Lines Type  
Microwave Absorber

⚠ Caution

● Rating

Do not use products beyond the rated current and rated voltage as this may create excessive heat and deteriorate the insulation resistance.

Notice

● Storage and Operating Conditions

<Operating Environment>

Do not use products in a chemical atmosphere such as chlorine gas, acid or sulfide gas.

Do not use products in the environment close to the organic solvent.

<Storage and Handling Requirements>

1. Storage Period

BNX series should be used within 12 months.  
Solderability should be checked if this period is exceeded.

2. Storage Conditions

- (1) Storage temperature: -10 to +40°C  
Relative humidity: 15 to 85%  
Avoid sudden changes in temperature and humidity.
- (2) Do not store products in a chemical atmosphere such as chlorine gas, acid or sulfide gas.

● Notice (Soldering and Mounting)

1. Cleaning

Do not clean BNX series (SMD Type).  
Before cleaning, please contact Murata engineering.

2. Soldering

Reliability decreases with improper soldering methods.  
Please solder by the standard soldering conditions shown in mounting information.

3. Other

Noise suppression levels resulting from Murata's EMI suppression filters EMIFIL<sup>®</sup> may vary, depending on the circuits and ICs used, type of noise, mounting pattern, mounting location, and other operating conditions. Be sure to check and confirm in advance the noise suppression effect of each filter, in actual circuits, etc. before applying the filter in a commercial-purpose equipment design.

● Handling

1. Resin Coating

Using resin for coating/molding products may affect the products performance.

So please pay careful attention in selecting resin. Prior to use, please make the reliability evaluation with the product mounted in your application set.

2. Handling of a Substrate (for BNX02□)

After mounting products on a substrate, do not apply any stress to the product caused by bending or twisting to the substrate when cropping the substrate, inserting and removing a connector from the substrate or tightening screw to the substrate. Excessive mechanical stress may cause cracking in the Product.

Bending

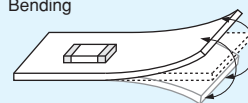

Twisting

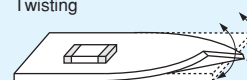

⚠ Note • Please read rating and ⚠ CAUTION (for storage, operating, rating, soldering, mounting and handling) in this catalog to prevent smoking and/or burning, etc.  
• This catalog has only typical specifications. Therefore, please approve our product specifications or transact the approval sheet for product specifications before ordering.

## ⚠ Caution

## ● Rating

Do not use products beyond the rated current and rated voltage as this may create excessive heat and deteriorate the insulation resistance.

## Notice

## ● Storage and Operating Conditions

<Operating Environment>

1. Do not use products in a chemical atmosphere such as chlorine gas, acid or sulfide gas.
2. Do not use products near water, oil or organic solvents.

<Storage and Handling Requirements>

1. Storage Period  
BNX Series should be used within 12 months.  
Solderability should be checked if this period is exceeded.
2. Storage Conditions
  - (1) Storage temperature: -10 to +40°C  
Relative humidity: 15 to 85%  
Avoid sudden changes in temperature and humidity.
  - (2) Do not store products in a chemical atmosphere such as chlorine gas, acid or sulfide gas.

## ● Notice (Soldering and Mounting)

1. Cleaning  
Failure and degradation of a product are caused by the cleaning method. When you clean in conditions that are not in mounting information, please contact Murata engineering.
2. Soldering  
Reliability decreases with improper soldering methods. Please solder by the standard soldering conditions shown in mounting information.
3. Other  
Noise suppression levels resulting from Murata's EMI suppression filters "EMIFIL" may vary, depending on the circuits and ICs used, type of noise, mounting pattern, lead wire length, mounting location, and other operating conditions. Be sure to check and confirm in advance the noise suppression effect of each filter, in actual circuits, etc. before applying the filter in a commercial-purpose equipment design.

## ● Notice (Appearance)

Although some part of the product surface seems to be white in some cases, do not care because it is the result of waxing process for humidity resistance improvement. This wax does not make bad affection to mechanical or electrical performance, reliability of the product.

⚠ Note • Please read rating and ⚠ CAUTION (for storage, operating, rating, soldering, mounting and handling) in this catalog to prevent smoking and/or burning, etc.  
• This catalog has only typical specifications. Therefore, please approve our product specifications or transact the approval sheet for product specifications before ordering.

## 1. Standard Land Pattern Dimensions

- Land Pattern + Solder Resist
  - Land Pattern
  - Solder Resist
  - Through Hole
- (in mm)

**BNX022  
BNX023  
BNX024  
BNX025**

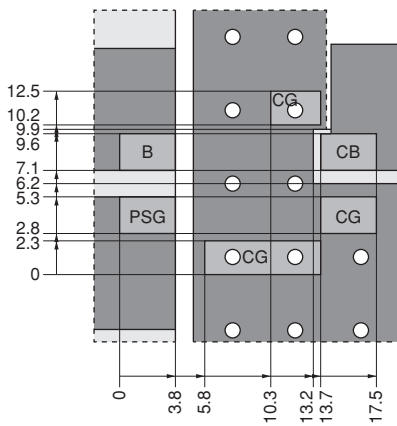

- (1) A double-sided print board (or multilayer board) as shown in the left figure is designed, and please apply a soldering Cu electrode with a product electrode to a "Land Pattern", apply resist to a "Land Pattern + Solder Resist" at Cu electrode.
- (2) This product is designed to meet large current. Please design PCB pattern which is connected to this product not to become too hot by applied large current.
- (3) Please drop CG on a ground electrode on the back layer (the same also in a multilayer case) by the through hole. And a surface to ground electrode layer may also take a large area as much as possible.
- (4) It is recommended to use a double-sided printed circuit board with BNX mounting on one side and the ground pattern on the other in order to maximize filtering performance, multiple feed through holes are required to maximize the BNX's connection to ground.
- (5) The ground pattern should be designed to be as large as possible to achieve maximum filtering performance.

### ● PCB Warping (for BNX02□)

PCB should be designed so that products are not subjected to the mechanical stress caused by warping the board.

Products should be located in the sideways direction (Length: a-b) to the mechanical stress.

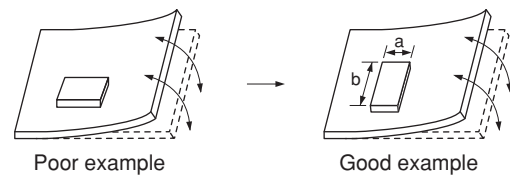

## 2. Solder Paste Printing and Adhesive Application

When reflow soldering the block type EMIFIL<sup>®</sup>, the printing must be conducted in accordance with the following cream solder printing conditions.

If too much solder is applied, the chip will be prone to

damage by mechanical and thermal stress from the PCB and may crack.

Standard land dimensions should be used for resist and copper foil patterns.

Series	Solder Paste Printing	Adhesive Application
<p><b>BNX022 BNX023 BNX024 BNX025</b></p>	<p>●Guideline of solder paste thickness: 150-200μm</p>	<div style="border: 1px solid black; height: 150px; width: 100%;"></div>

⚠Note • Please read rating and ⚠CAUTION (for storage, operating, rating, soldering, mounting and handling) in this catalog to prevent smoking and/or burning, etc.  
• This catalog has only typical specifications. Therefore, please approve our product specifications or transact the approval sheet for product specifications before ordering.

**3. Standard Soldering Conditions**

(1) Soldering Methods

Use reflow soldering methods only.  
 Use standard soldering conditions when soldering block type EMIFIL® SMD type.  
 In cases where several different parts are soldered, each having different soldering conditions, use those conditions requiring the least heat and minimum time.

Solder: Use Sn-3.0Ag-0.5Cu solder. Use of Sn-Zn based solder will deteriorate performance of products.

Flux:

- Use Rosin-based flux.  
 In case of using RA type solder, products should be cleaned completely with no residual flux.
- Do not use strong acidic flux (with chlorine content exceeding 0.20wt%)
- Do not use water-soluble flux.

For additional mounting methods, please contact Murata.

(2) Soldering Profile

- Reflow Soldering Profile (Sn-3.0Ag-0.5Cu solder)

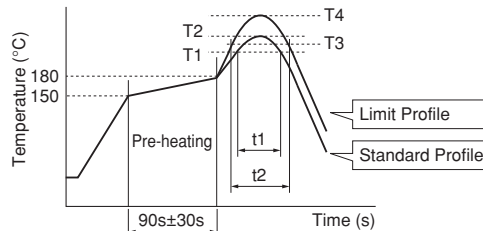

Series	Standard Profile				Limit Profile			
	Heating		Peak Temperature (T2)	Cycle of Reflow	Heating		Peak Temperature (T4)	Cycle of Reflow
	Temp. (T1)	Time. (t1)			Temp. (T3)	Time. (t2)		
<b>BNX022/023/024/025</b>	220°C min.	30 to 60s	250±3°C	2 times max.	230°C min.	60s max.	260°C/10s	2 times max.

(3) Reworking with Solder Iron

The following conditions must be strictly followed when using a soldering iron.  
 Pre-heating: 150°C 60s min.  
 Soldering iron power output: 100W max.  
 Temperature of soldering iron tip / Soldering time / Times:  
 450°C max. / 5s max. / 2 time

Do not allow the tip of the soldering iron to directly contact the chip.  
 For additional methods of reworking with a soldering iron, please contact Murata engineering.

**4. Cleaning**

Do not clean BNX022/023/024/025 series. In case of cleaning, please contact Murata engineering.

△Note • Please read rating and △CAUTION (for storage, operating, rating, soldering, mounting and handling) in this catalog to prevent smoking and/or burning, etc.  
 • This catalog has only typical specifications. Therefore, please approve our product specifications or transact the approval sheet for product specifications before ordering.

## 1. Mounting Hole

■ Mounting holes should be designed as specified below.

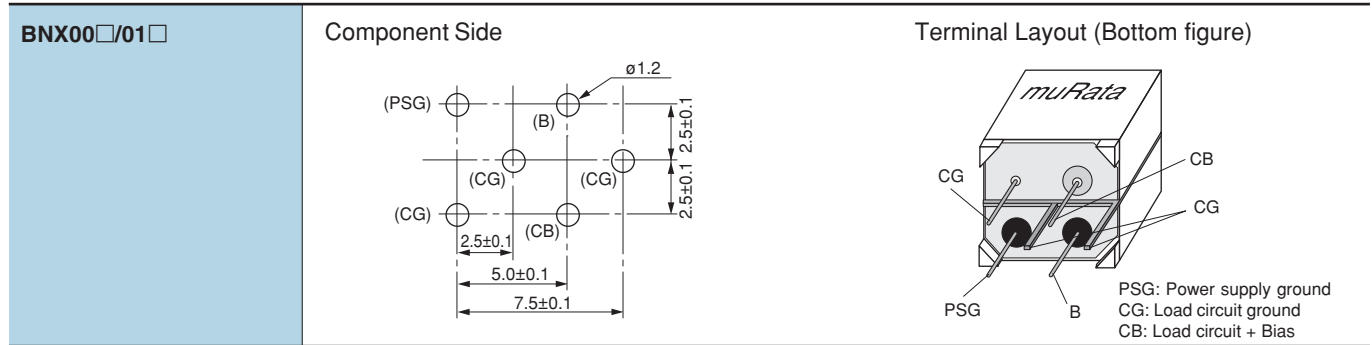

## 2. Using the Block Type EMIFIL® (Lead Type) Effectively

### (1) How to use effectively

This product effectively prevents undesired radiation and external noise from going out / entering the circuit by grounding the high frequency components which cause noise problems. Therefore, grounding conditions may affect the performance of the filter and attention should be paid to the following for effective use.

- (a) Design maximized grounding area in the P.C. board, and grounding pattern for all the grounding terminals of the product to be connected. (Please follow the specified recommendations.)
- (b) Minimize the distance between ground of the P.C. board and the ground plate of the product. (Recommend using the through hole connection between grounding area both of component side and bottom side.)
- (c) Insert the terminals into the holes on P.C. board completely.
- (d) Don't connect PSG terminal with CG terminal directly. (See the item 1. Terminal Layout)

### (2) Self-heating

Though this product has a large rated current, localized selfheating may be caused depending on soldering conditions. To avoid this, attention should be paid to the following:

- (a) Use P.C. board with our recommendation on hole diameter / land pattern dimensions, mentioned in the right hand drawing, especially for 4 terminals which pass current.
- (b) Solder the terminals to the P.C. board with soldercover area at least 90%. Otherwise, excess self-heating at connection between terminals and P.C. board may lead to smoke and / or fire of the product even when operating at rated current.
- (c) After installing this product in your product, please make sure the self-heating is within the rated current recommended.

### P. C. Board Patterns

Use a bilateral P.C. board. Insert the BNX into the P.C.board until the root of the terminal is secured, then solder.

#### (1) Component Side View

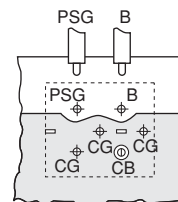

#### (2) Bottom View

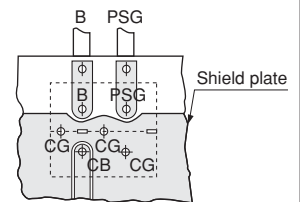

■ Copper foil pattern

### Recommended Land Pattern

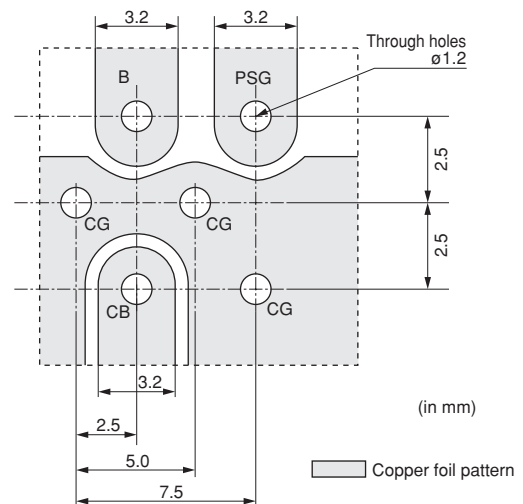

△Note • Please read rating and △CAUTION (for storage, operating, rating, soldering, mounting and handling) in this catalog to prevent smoking and/or burning, etc.  
• This catalog has only typical specifications. Therefore, please approve our product specifications or transact the approval sheet for product specifications before ordering.

**3. Soldering**

- (1) Use Sn-3.0Ag-0.5Cu solder.
- (2) Use Rosin-based flux. Do not use strong acidic flux with halide content exceeding 0.2wt% (chlorine conversion value).
- (3) Products and the leads should not be subjected to any mechanical stress during the soldering process, or while subjected to the equivalent high temperatures.
- (4) Standard flow soldering profile

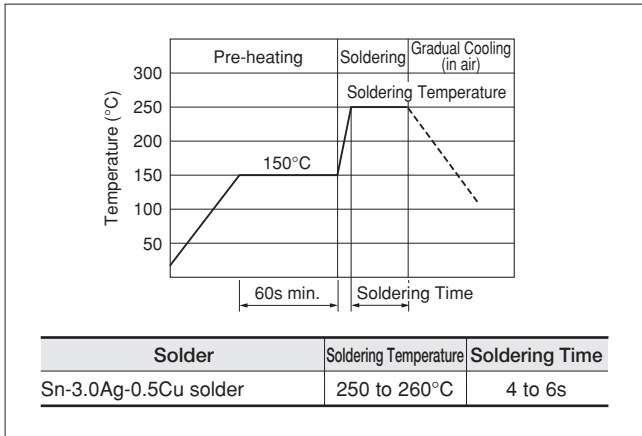

**4. Cleaning**

Clean the block Type EMIFIL®(Lead Type) in the following conditions.

- (1) Cleaning temperature should be limited to 60°C max. (40°C max for alcohol type cleaner).
- (2) Ultrasonic cleaning should comply with the following conditions, avoiding the resonance phenomenon at the mounted products and P.C.B.
  - Power: 20W/liter max.
  - Frequency: 28 to 40kHz
  - Time: 5 min. max.
- (3) Cleaner
  - (a) Alcohol type cleaner  
Isopropyl alcohol (IPA)
  - (b) Aqueous agent  
Pine Alpha ST-100S

- (4) There should be no residual flux or residual cleaner left after cleaning.
  - In the case of using aqueous agent, products should be dried completely after rinsing with de-ionized water in order to remove the cleaner.
- (5) The surface of products may become dirty after cleaning, but there is no deterioration on mechanical, electrical characteristics and reliability.
- (6) Other cleaning: Please contact us.

⚠Note • Please read rating and ⚠CAUTION (for storage, operating, rating, soldering, mounting and handling) in this catalog to prevent smoking and/or burning, etc.  
• This catalog has only typical specifications. Therefore, please approve our product specifications or transact the approval sheet for product specifications before ordering.

Chip Ferrite Bead  
Chip EMIFIL®  
Chip Common Mode Choke Coil  
Soldering and Mounting  
Block Type EMIFIL®  
Microwave Absorber



## Minimum Quantity and Dimensions of 24mm Width Embossed Tape

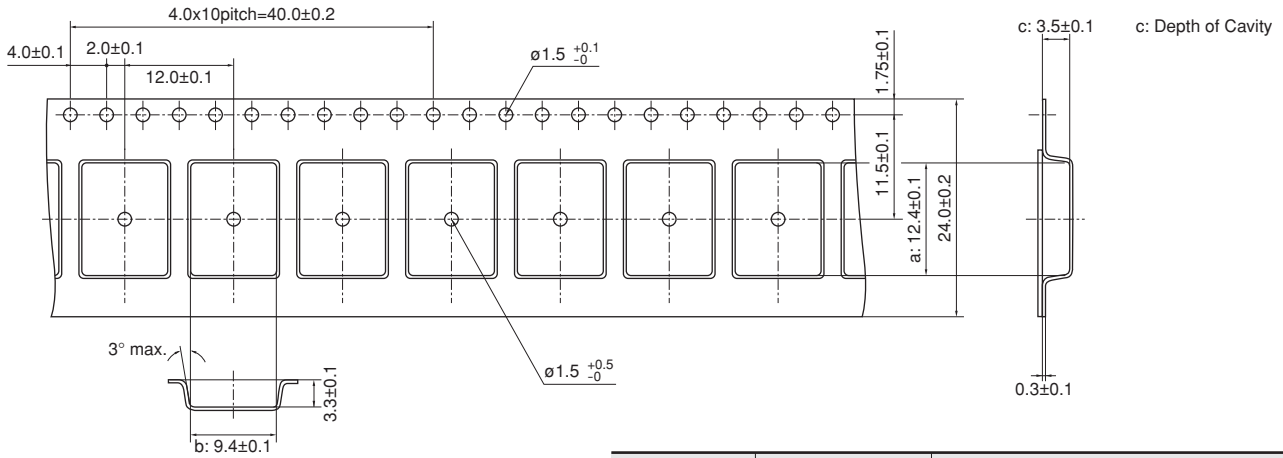

Dimension of the cavity is measured at the bottom side.

Part Number	Dimensions			Minimum Qty. (pcs.)		
	a	b	c	ø180mm Reel	ø330mm Reel	Bulk
BNX022/023	12.4	9.4	3.5	400	1500	100

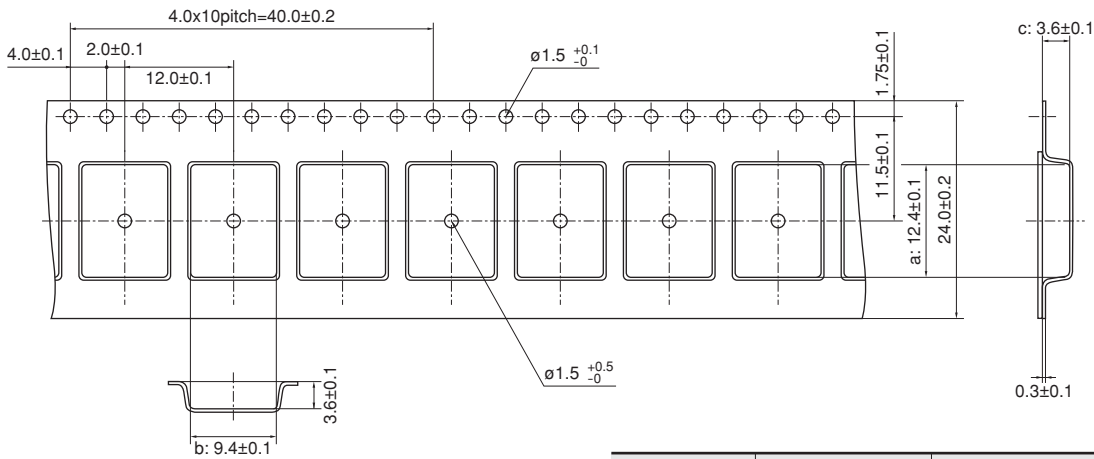

Dimension of the cavity is measured at the bottom side.

Part Number	Dimensions			Minimum Qty. (pcs.)		
	a	b	c	ø180mm reel	ø330mm reel	Bulk
BNX024/025	12.4	9.4	3.6	400	1500	100

(in mm)

"Minimum Quantity" means the number of units of each delivery or order. The quantity should be an integral multiple of the "Minimum Quantity."

⚠Note • Please read rating and ⚠CAUTION (for storage, operating, rating, soldering, mounting and handling) in this catalog to prevent smoking and/or burning, etc.  
• This catalog has only typical specifications. Therefore, please approve our product specifications or transact the approval sheet for product specifications before ordering.

# BNX Block Type EMIFIL® Design Kits



## ●EKEPBLCKAD-KIT

No.	Part Number	Quantity (pcs.)	Common Mode Impedance (at 10MHz, 20 degrees C)	Rated Voltage (Vdc)	Rated Current (A)
1	PLT10HH450180PN	2	45Ω (Typ.)	300	18
2	PLT10HH101150PN	2	100Ω (Typ.)	300	15
3	PLT10HH401100PN	2	400Ω (Typ.)	100	10
4	PLT10HH501100PN	2	500Ω (Typ.)	100	10
5	PLT10HH9016R0PN	2	900Ω (Typ.)	100	6
6	PLT10HH1026R0PN	2	1000Ω (Typ.)	100	6

No.	Part Number	Quantity (pcs.)	Insertion Loss	Rated Voltage (Vdc)	Rated Current (A)
7	BNX002-01	1	1MHz to 1GHz : 40dB min.	50	10
8	BNX003-01	1	5MHz to 1GHz : 40dB min.	150	10
9	BNX005-01	1	1MHz to 1GHz : 40dB min.	50	15
10	BNX012-01	1	1MHz to 1GHz : 40dB min.	50	15
11	BNX016-01	1	100kHz to 1GHz : 40dB min.	25	15
12	BNX022-01	2	1MHz to 1GHz : 35dB min.	50	10
13	BNX023-01	2	1MHz to 1GHz : 35dB min.	100	15
14	BNX024H01	2	100kHz to 1GHz : 35dB min.	50	15
15	BNX025H01	2	50kHz to 1GHz : 35dB min.	25	15

△Note • Please read rating and △CAUTION (for storage, operating, rating, soldering, mounting and handling) in this catalog to prevent smoking and/or burning, etc.  
 • This catalog has only typical specifications. Therefore, please approve our product specifications or transact the approval sheet for product specifications before ordering.

# EA

## Microwave Absorber

Part Numbering .....	234
Product Detail .....	235
Notice .....	238

Chip Ferrite Bead

Chip EMIFIL®

Chip Common Mode Choke Coil

Block Type EMIFIL®

Microwave Absorber

⚠Note • Please read rating and ⚠CAUTION (for storage, operating, rating, soldering, mounting and handling) in this catalog to prevent smoking and/or burning, etc.  
• This catalog has only typical specifications. Therefore, please approve our product specifications or transact the approval sheet for product specifications before ordering.

# EA Microwave Absorber Part Numbering

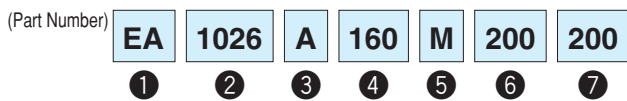

## ① Product ID

Product ID	
<b>EA</b>	Microwave Absorber

## ② Sheet Type

Code	Sheet Type
<b>10□□</b>	Iron carbonyl type (UL certified type/Halogen Free type)
<b>2070</b>	Metal Flake Powder (Halogen Free type)
<b>2100</b>	Metal Flake Powder (UL certified type)
<b>3008</b>	Magnetic material (UL certified type/Halogen Free type)

## ③ Adhesive Tape Type

Code	Adhesive Tape Type
<b>A</b>	Standard tape type (Halogen Free type)
<b>B</b>	Thin Adhesive tape type (Halogen Free type)
<b>L</b>	No tape type
<b>U</b>	UL certified type (Halogen Free type)

## ④ Sheet Thickness

Expressed by 3 digits including the second decimal place in mm.

Ex.)

Code	Sheet Thickness
<b>020</b>	0.20mm

## ⑤ Unit of Dimension

One capital letter expresses Unit of Dimension (⑥) and Dimensions Length (⑦).

Code	Unit of Dimension
<b>M</b>	in mm (Standard)
<b>C</b>	in cm (Standard)

Standard shape is a rectangle.

Please contact us for other shapes.

## ⑥ Dimension (Length)

Expressed by 3 digits including the first decimal place.

## ⑦ Dimension (Width)

Expressed by 3 digits including the first decimal place.

Ex.)

Code	Dimension (Length × Width)
<b>M300150</b>	30.0×15.0 mm
<b>C150100</b>	15.0×10.0 cm

△Note • Please read rating and △CAUTION (for storage, operating, rating, soldering, mounting and handling) in this catalog to prevent smoking and/or burning, etc.  
• This catalog has only typical specifications. Therefore, please approve our product specifications or transact the approval sheet for product specifications before ordering.

# EA10 Series

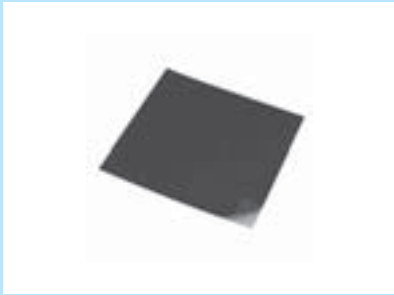

### ■ Packaging

When inquiring, please contact us with size code, referring to "Part Numbering."

### ■ Rated Value

Part Number	Applicable Frequency (Typ.)	Thickness (Typ.)	Flame Class	Halogen	Operating Temperature Range
EA1026A100	20.0GHz	1.0mm	UL94V-0	Halogen Free	-40°C to +80°C
EA1026A160	11.5GHz	1.6mm	UL94V-0	Halogen Free	-40°C to +80°C
EA1026A180	10.0GHz	1.8mm	UL94V-0	Halogen Free	-40°C to +80°C
EA1046A180	5.8GHz	1.8mm	UL94V-0	Halogen Free	-40°C to +80°C
EA1075A270	2.5GHz	2.7mm	UL94V-0	Halogen Free	-40°C to +80°C

### ■ Reflection Loss (Typ.)

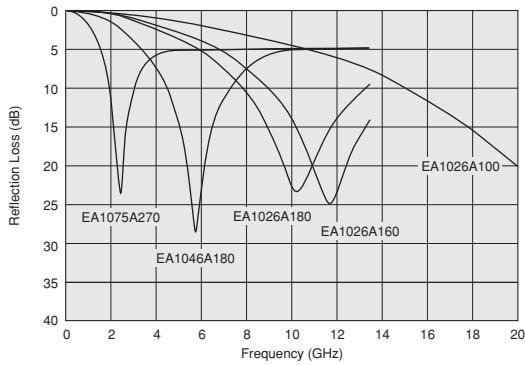

⚠Note • Please read rating and ⚠CAUTION (for storage, operating, rating, soldering, mounting and handling) in this catalog to prevent smoking and/or burning, etc.  
 • This catalog has only typical specifications. Therefore, please approve our product specifications or transact the approval sheet for product specifications before ordering.

# EA20/EA21 Series



### ■ Packaging

When inquiring, please contact us with size code, referring to "Part Numbering."

### ■ Rated Value

Part Number	Applicable Frequency (Typ.)	Thickness (Typ.)	Flame Class	Halogen	Operating Temperature Range
EA2070A020	0.1 to 3.0GHz	0.20mm	-	Halogen Free	-40°C to +120°C
EA2070A050	0.1 to 3.0GHz	0.50mm	-	Halogen Free	-40°C to +120°C
EA2070A100	0.1 to 3.0GHz	1.00mm	-	Halogen Free	-40°C to +120°C
EA2070B005	0.1 to 3.0GHz	0.05mm	-	Halogen Free	-40°C to +120°C
EA2070B010	0.1 to 3.0GHz	0.10mm	-	Halogen Free	-40°C to +120°C
EA2070B013	0.1 to 3.0GHz	0.13mm	-	Halogen Free	-40°C to +120°C
EA2070B020	0.1 to 3.0GHz	0.20mm	-	Halogen Free	-40°C to +120°C
EA2070B050	0.1 to 3.0GHz	0.50mm	-	Halogen Free	-40°C to +120°C
EA2100A020	0.1 to 3.0GHz	0.20mm	UL94V-0	-	-40°C to +120°C
EA2100A050	0.1 to 3.0GHz	0.50mm	UL94V-0	-	-40°C to +120°C
EA2100A100	0.1 to 3.0GHz	1.00mm	UL94V-0	-	-40°C to +120°C
EA2100B020	0.1 to 3.0GHz	0.20mm	UL94V-0	-	-40°C to +120°C
EA2100B050	0.1 to 3.0GHz	0.50mm	UL94V-0	-	-40°C to +120°C
EA2100B100	0.1 to 3.0GHz	1.00mm	UL94V-0	-	-40°C to +120°C

### ■ Magnetic Permeability-Reluctance

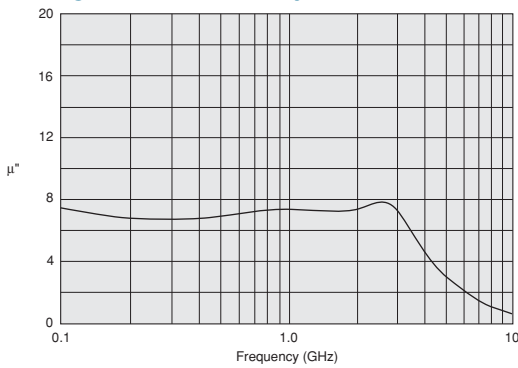

⚠Note • Please read rating and ⚠CAUTION (for storage, operating, rating, soldering, mounting and handling) in this catalog to prevent smoking and/or burning, etc.  
 • This catalog has only typical specifications. Therefore, please approve our product specifications or transact the approval sheet for product specifications before ordering.

Chip Ferrite Bead  
Chip EMIFIL®  
Chip Common Mode Choke Coil  
Block Type EMIFIL®  
Microwave Absorber

# EA30 Series



### ■ Packaging

When inquiring, please contact us with size code, referring to "Part Numbering."

### ■ Rated Value

Part Number	Applicable Frequency (Typ.)	Thickness (Typ.)	Flame Class	Halogen	Operating Temperature Range
EA3008U025	0.1 to 3.0GHz	0.25mm	UL94V-0	Halogen Free	-40°C to +120°C
EA3008U035	0.1 to 3.0GHz	0.35mm	UL94V-0	Halogen Free	-40°C to +120°C
EA3008U050	0.1 to 3.0GHz	0.50mm	UL94V-0	Halogen Free	-40°C to +120°C
EA3008U100	0.1 to 3.0GHz	1.00mm	UL94V-0	Halogen Free	-40°C to +120°C
EA3008U250	0.1 to 3.0GHz	2.50mm	UL94V-0	Halogen Free	-40°C to +120°C

### ■ Magnetic Permeability-Reluctance

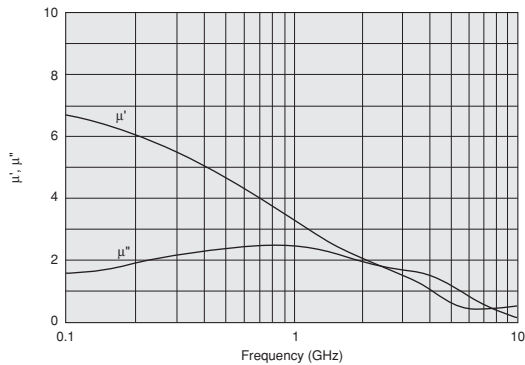

⚠Note • Please read rating and ⚠CAUTION (for storage, operating, rating, soldering, mounting and handling) in this catalog to prevent smoking and/or burning, etc.  
 • This catalog has only typical specifications. Therefore, please approve our product specifications or transact the approval sheet for product specifications before ordering.

## Notice

## ● Storage and Operating Conditions

## 1. Adhesive Tape Stress

This product is designed to use adhesive tape to hold itself to the object.

And please avoid causing mechanical stress by bending or variation of the object.

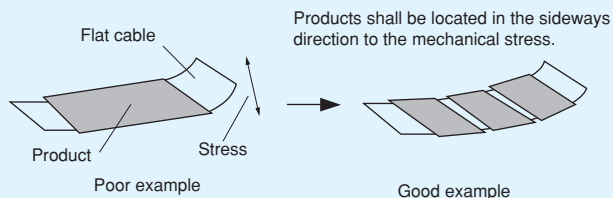

## 2. Cleaning

Avoid cleaning this product.

## 3. Handling of the Product

Adhesive tape must be clean to maintain the quality of adhesion.

Please wipe off any dirt, dust and any kind of oil from the surface of the object before use.

## 4. Storage Conditions

## (1) Storage period

Products that were inspected by Murata over 6 months ago should be examined and used. This can be confirmed by the inspection No. marked on the container.

Adhesiveness should be checked if this period is exceeded.

## (2) Storage conditions

· Products should be stored in the warehouse in the following conditions:

Temperature: -10 to +40°C

Humidity: 30 to 70% relative humidity

No rapid change of temperature or humidity

· Products should be stored in the warehouse without heat shock condition, vibration, direct sunlight and so on.



# Product Guide by Size

Which Size? inch (mm)	Inductor Type	Capacitor Type			Common Mode Choke Coils	Block Type L×W×T(mm)
		Simple Capacitor	LC(RC) Combined	T Circuit Filter Feed Through Type		
01005 (0402)	BLM02AX <small>p24</small> BLM02BX <small>p26</small>					12×11×max13 <small>p223</small> BNX002-01 BNX003-01 Lead
0201 (0603)	BLM03AG <small>p32</small> BLM03AX <small>p30</small> BLM03B <small>p34</small> BLM03E <small>p87</small> BLM03P <small>p27</small> BLM03H <small>p85</small>					
025020 (0605)					DLP0QS <small>p186</small>	
03025 (0806)					DLP0NS <small>p187</small>	
0402 (1005)	BLM15AG <small>p42</small> BLM15AX <small>p40</small> BLM15B <small>p44</small> BLM15HD <small>p88</small> BLM15P <small>p36</small> BLM15HB <small>p88</small> BLM15E <small>p90</small> BLM15GG <small>p91</small> BLM15HG <small>p88</small> BLM15GA <small>p91</small>	NFM15CC <small>p134</small> NFM15PC <small>p123</small>	NFL15ST <small>p140</small>			12×11×max13.5 <small>p223</small> BNX005-01 Lead
05025 (1506)					DLP1ND <small>p193</small>	
0504 (1210)					DLM11G <small>p184</small> DLM11S <small>p185</small> DLP11S/11R/11T <small>p189</small> <small>p190</small> <small>p191</small>	
0603 (1608)	BLM18A <small>p56</small> BLM18E <small>p96</small> BLM18T <small>p62</small> BLM18HE <small>p92</small> BLM18B <small>p58</small> BLM18HG <small>p92</small> BLM18R <small>p63</small> BLM18HD <small>p92</small> BLM18P <small>p50</small> BLM18HB <small>p92</small> BLM18K <small>p52</small> BLM18HK <small>p92</small> BLM18S <small>p54</small> BLM18G <small>p98</small>	NFM18CC <small>p135</small> NFM18PS <small>p125</small> NFM18PC <small>p126</small>	NFL18ST <small>p141</small> NFL18SP <small>p143</small>			12×11×max8.5 <small>p224</small> BNX012-01 BNX016-01 Lead
Array			NFA18SL <small>p145</small> NFA18SD <small>p146</small> <small>p147</small>			
0804 (2010) Array	BLA2AA <small>p80</small> BLA2AB <small>p80</small>				DLP2AD <small>p194</small>	
0805 (2012)	BLM21A <small>p68</small> BLM21R <small>p73</small> BLM21B <small>p70</small> BLM21P <small>p66</small>	NFM21CC <small>p136</small> NFM21PS <small>p128</small> NFM21PC <small>p129</small>	NFL21SP <small>p144</small> NFR21GD <small>p152</small>		DLW21S <small>p197</small> DLW21H <small>p199</small>	
Array			NFA21SL <small>p148</small> <small>p149</small>			
1205 (3212)		NFM3DCC <small>p137</small> NFM3DPC <small>p130</small>				9.1×12.1×max3.3 <small>p221</small> BNX022-01 BNX023-01 SMD
1206 (3216)	BLM31P <small>p75</small>	NFM31PC <small>p131</small> NFM31KC <small>p132</small>	NFW31SP <small>p150</small>	NFE31PT <small>p121</small>	DLP31S <small>p192</small> DLW31S <small>p200</small> DLP31D <small>p196</small>	
Array	BLA31A <small>p83</small> BLA31B <small>p83</small>		NFA31CC <small>p139</small> NFA31GD <small>p153</small>			
1210 (3225)	BLE32P <small>p79</small>					
1806 (4516)	BLM41P <small>p77</small>	NFM41CC <small>p138</small> NFM41PC <small>p133</small>				
1812 (4532)					DLW43S <small>p201</small>	9.1×12.1×max3.7 <small>p221</small> BNX024H01 BNX025H01 SMD
2014 (5036)					DLW5AH <small>p177</small> DLW5AT <small>p179</small> <small>p181</small>	
2020 (5050)					DLW5BS <small>p177</small> DLW5BT <small>p179</small> <small>p181</small>	
2606 (6816)				NFE61PT <small>p122</small>		

△Note • Please read rating and △CAUTION (for storage, operating, rating, soldering, mounting and handling) in this catalog to prevent smoking and/or burning, etc.  
• This catalog has only typical specifications. Therefore, please approve our product specifications or transact the approval sheet for product specifications before ordering.

## Part Number Quick Reference

### BL□ Series

BLA2AA	p80
BLA2AB	p80
BLA31A	p83
BLA31B	p83
BLE32P	p79
BLM02AX	p24
BLM02BX	p26
BLM03AG	p32
BLM03AX	p30
BLM03B	p34
BLM03E	p87
BLM03H	p85
BLM03PG	p27
BLM03PX	p28
BLM15AG	p42
BLM15AX	p40
BLM15B	p46
BLM15BX	p44
BLM15E	p90
BLM15GA	p91
BLM15GG	p91
BLM15HB	p88
BLM15HD	p88
BLM15HG	p88
BLM15PG/PD	p38
BLM15PX	p36
BLM18A	p56
BLM18B	p58
BLM18EG	p96
BLM18G	p98
BLM18HB	p92
BLM18HD	p92
BLM18HE	p92
BLM18HG	p92
BLM18HK	p92
BLM18K	p52
BLM18P	p50
BLM18R	p63
BLM18S	p54
BLM18T	p62
BLM21A	p68
BLM21B	p70
BLM21P	p66
BLM21R	p73
BLM31P	p75
BLM41P	p77

### NF□ Series

NFA18SD	p147
NFA18SL	p145
NFA21SL	p148
NFA31CC	p139
NFA31GD	p153
NFE31PT	p121
NFE61PT	p122
NFL15ST	p140
NFL18SP	p143
NFL18ST	p141
NFL21SP	p144
NFM15CC	p134
NFM15PC	p123
NFM18CC	p135
NFM18PC	p126
NFM18PS	p125
NFM21CC	p136
NFM21PC	p129
NFM21PS	p128
NFM31KC	p132
NFM31PC	p131
NFM3DCC	p137
NFM3DPC	p130
NFM41CC	p138
NFM41PC	p133
NFR21GD	p152
NFW31SP	p150

### DL□ (PL□) Series

DLM11G	p184
DLM11S	p185
DLP0NS	p187
DLP0QS	p186
DLP11S/11R/11T	p189
DLP1ND	p193
DLP2AD	p194
DLP31D	p196
DLP31S	p192
DLW21H	p199
DLW21S	p197
DLW31S	p200
DLW43S	p201
DLW5AH	p177
DLW5AT	p179
DLW5BS	p177
DLW5BT	p179
PLT10H	p202

### BNX Series

BNX002	p223
BNX003	p223
BNX005	p223
BNX012	p224
BNX016	p224
BNX022	p221
BNX023	p221
BNX024	p221
BNX025	p221

### EA Series

EA10	p235
EA20	p236
EA21	p236
EA30	p237

## Alphabetic Product Name Index

3 Terminal Filter	p111	Chip EMIFIL® LC Combined Type Array	p145
Block Type EMIFIL® LC Combined Type	p221	Chip EMIFIL® LC Combined Wire Wound Type	p150
Chip Common Mode Choke Coil Film Type	p186	Chip EMIFIL® RC Combined Type	p152.153
Chip Common Mode Choke Coil Film Type Array	p193	Chip EMIFIL® RC Combined Type Array	p153
Chip Common Mode Choke Coil Multilayer Type	p184	Chip Ferrite Bead	p13
Chip Common Mode Choke Coil Wire Wound Type	p197	Chip Ferrite Bead Array	p80
Chip Common Mode Choke Coil Wire Wound Type For Large Current	p177	Chip Ferrite Bead For GHz Band Noise	p85
Chip EMIFIL® Array	p80.83.139.145.148.153	Chip Ferrite Bead For High-GHz Band Noise	p91
Chip EMIFIL® Capacitor Type	p111	Common Mode Filter	p169
Chip EMIFIL® Capacitor Type Array	p139	EMIFIL®	p13.111.169.217
Chip EMIFIL® Feed Through Type	p121	EMI Suppression Filter	p13.111.169.217
Chip EMIFIL® For Large Current	p27.121.123.125.177.221	LC Combined L Circuit Array	p145
Chip EMIFIL® Inductor Type	p13	L Circuit Filter	p145
Chip EMIFIL® LC Combined Multilayer Type	p140	Microwave Absorber	p233
Chip EMIFIL® LC Combined T Circuit Type	p121.140	PI Circuit Filter	p143.144.150
Chip EMIFIL® LC Combined Type	p121	T Circuit Filter	p121.140

⚠Note • Please read rating and ⚠CAUTION (for storage, operating, rating, soldering, mounting and handling) in this catalog to prevent smoking and/or burning, etc.  
• This catalog has only typical specifications. Therefore, please approve our product specifications or transact the approval sheet for product specifications before ordering.

Please refer to catalogs below for ferrite cores, Microwave Absorber and leaded EMIFIL®.

## Ferrite Core, Microwave Absorber

### Ferrite Core for EMI Suppression Microwave Absorber

**Contents** Thin Type Sandwich Core <FSSA>  
Core for Flat Cables <FSRC>  
Beads Core <FSRH>  
Ring Core <FSRB>  
Microwave Absorber <EA>

This Catalog is PDF version only. Please refer to following URL.  
<http://www.murata.com/products/catalog/pdf/o63e.pdf>



## Lead Type EMIFIL®

### EMI Suppression Filters (Lead Type EMIFIL®)

**Contents** Ferrite Beads Inductors <BL01/02/03>  
Disc Type EMIFIL® <DS□6/DS□9>  
EMIGUARD® (EMIFIL® with Varistor Function)  
<VF□3/VF□6/VF□9>  
Common Mode Choke Coils <PLT>



# EMICON-FUN!

Please check Murata's newsletter!  
 You can learn about electric parts with fun.  
[http://www.murata.com/products/emicon\\_fun/](http://www.murata.com/products/emicon_fun/)

EMICON-FUN! disseminated widely from basics (principles, characteristics, mounting, etc.) of capacitors, EMI suppression filters and inductors to information can practically be used.  
 Updated information is also distributed via the mail magazine.

Click here to register as reader → [http://go.murata.co.jp/Email\\_Newsletter\\_EN.html](http://go.murata.co.jp/Email_Newsletter_EN.html)

You can register from Murata Manufacturing Web site page TOP.  
<http://www.murata.com/products/>



← This banner is the entrance of register form

email Magazine: Have fun while learning about electronic components

## EMICON-FUN!

Wide range of information about capacitors, noise suppression filters, and inductors.

Murata Newsletter  
 EMICON-FUN! also available  
 Click here to register as reader

Enter keywords to be searched

### Capacitor Room

- Technical Report Evolving Capacitors - Multilayer Ceramic Capacitors - Part 1 (part 2/2)
- Technical Report Evolving Capacitors - Multilayer Ceramic Capacitors Part 1 (part 1 of 2)
- Multilayer Ceramic Capacitor GCO Series for Conductive Adhesives
- E21 series lead-type multilayer ceramic capacitors compatible to 120°C for automotive applications
- What kind of layout helps prevent chip multilayer ceramic capacitors from cracking?

### Noise suppression filter Room

- Basics of Noise Countermeasures - Lesson 12: How to Make the Best Use of LC Component-type EMI filters
- Basics of Noise Countermeasures - Lesson 11: Notes on the Use of Chip J-Terminal Capacitors
- Basics of Noise Countermeasures - Lesson 10: Precautions for Using Chip Ferrite Beads
- Why is differential transmission used for high-speed transmission?
- Birth of the BLM-E series chip ferrite beads - Entering unexplored BLM territory

### Inductor Room

- Murata Develops World's Smallest Chip Inductor - 00804 size (0.23 x 0.127 mm)
- World's highest inductance value! Expanded lineup of ultra-compact E201 series (MLT series) new high-frequency chip inductors for smartphones - the LQP101TN\_02 series
- Accelerate of inductor development [No. 7] Days working about high-frequency high-speed assessment technology
- Accelerate about inductor development [No. 6] The new product inspired by a swing!
- Accelerate of inductor development [No. 5] Trends in LQH with mounting technology

### For the EARTH

- Introducing Murata's school classes: What we can do for the children who will shape the earth's future
- Special Feature on the Environment, Part 1 "Toward a Low-carbon Society - Initiatives for Global Warming Prevention."

email Magazine: Have fun while learning about electronic components

EMICON-FUN!  
 The index of June 14 issue

- Inductor Room
- Product News
- Proposal of the Loss Reduction in the RF Circuit
- Industry Pickup - Smart Phones

Expertly written articles explain the basics of capacitors, inductors and EMI suppression filters.

Product News

- Large Current Common Mode Coil for Automotive Available <PLT10H series>
- 1. Meets large current up to 18A max. suitable for power lines.
- 2. Suitable for surface mounting.
- 3. Large common mode impedance up to 1000ohm [at 10mhz] enables good noise suppression effect.
- 4. Wide operating temperature range from -55°C to 125°C. [PLT10HH9016R0 / 401100 / 101150 / 450180]

<http://newsletter.murata.co.jp/c/p?12cel.nY3hk>

△Note • Please read rating and △CAUTION (for storage, operating, rating, soldering, mounting and handling) in this catalog to prevent smoking and/or burning, etc.  
 • This catalog has only typical specifications. Therefore, please approve our product specifications or transact the approval sheet for product specifications before ordering.

# Global Locations

For details please visit [www.murata.com](http://www.murata.com)



## ⚠ Note

### 1 Export Control

#### For customers outside Japan:

No Murata products should be used or sold, through any channels, for use in the design, development, production, utilization, maintenance or operation of, or otherwise contribution to (1) any weapons (Weapons of Mass Destruction [nuclear, chemical or biological weapons or missiles] or conventional weapons) or (2) goods or systems specially designed or intended for military end-use or utilization by military end-users.

#### For customers in Japan:

For products which are controlled items subject to the "Foreign Exchange and Foreign Trade Law" of Japan, the export license specified by the law is required for export.

2 Please contact our sales representatives or product engineers before using the products in this catalog for the applications listed below, which require especially high reliability for the prevention of defects which might directly damage a third party's life, body or property, or when one of our products is intended for use in applications other than those specified in this catalog.

- ① Aircraft equipment
- ② Aerospace equipment
- ③ Undersea equipment
- ④ Power plant equipment
- ⑤ Medical equipment
- ⑥ Transportation equipment (vehicles, trains, ships, etc.)
- ⑦ Traffic signal equipment
- ⑧ Disaster prevention / crime prevention equipment
- ⑨ Data-processing equipment
- ⑩ Application of similar complexity and/or reliability requirements to the applications listed above

3 Product specifications in this catalog are as of March 2014. They are subject to change or our products in it may be discontinued without advance notice. Please check with our sales representatives or product engineers before ordering. If there are any questions, please contact our sales representatives or product engineers.

4 Please read rating and ⚠CAUTION (for storage, operating, rating, soldering, mounting and handling) in this catalog to prevent smoking and/or burning, etc.

5 This catalog has only typical specifications. Therefore, please approve our product specifications or transact the approval sheet for product specifications before ordering.

6 Please note that unless otherwise specified, we shall assume no responsibility whatsoever for any conflict or dispute that may occur in connection with the effect of our and/or a third party's intellectual property rights and other related rights in consideration of your use of our products and/or information described or contained in our catalogs. In this connection, no representation shall be made to the effect that any third parties are authorized to use the rights mentioned above under licenses without our consent.

7 No ozone depleting substances (ODS) under the Montreal Protocol are used in our manufacturing process.

Murata Manufacturing Co., Ltd.

[www.murata.com](http://www.murata.com)

**muRata**  
INNOVATOR IN ELECTRONICS

# Mouser Electronics

Authorized Distributor

Click to View Pricing, Inventory, Delivery & Lifecycle Information:

## Murata:

[BLM15AG100SN1D](#) [BLM15BB050SN1D](#) [BLM15BB100SN1D](#) [BLM15BB121PN1D](#) [BLM15BB121SN1D](#)  
[BLM15BB220SN1D](#) [BLM15BB221SN1D](#) [BLM15BB750SN1D](#) [BLM15BD421PN1D](#) [BLM15BD471SN1D](#)  
[BLM15BD601SN1D](#) [BLM18AG151SN1D](#) [BLM18BA470SN1D](#) [BLM18BB151SN1D](#) [BLM18BB471SN1D](#)  
[BLM18BD151SN1D](#) [BLM18BD222SN1D](#) [BLM18BD331SN1D](#) [BLM18EG391TN1D](#) [BLM18HB331SN1D](#)  
[BLM18HB601SN1D](#) [BLM18HK471SN1D](#) [BLM18RK121SN1D](#) [BLM18RK221SN1D](#) [BLM21AF121SH1D](#)  
[BLM21AH102SH1D](#) [BLM21AJ401SH1D](#) [BLM21AJ601SH1D](#) [BLM21BB151SN1D](#) [BLM21BD151SN1D](#)  
[BLM21BD182SN1D](#) [BLM21BD222TN1D](#) [BLM21BD331SN1D](#) [BLM21RK221SN1D](#) [BLM31AF700SH1L](#)  
[BLM31AJ260SH1L](#) [BLM31AJ601SH1L](#) [BLM31BE601FH1L](#) [BLM31BE601SH1L](#) [BLM41AF151SH1L](#)  
[BLM41AF800SH1L](#) [BLM41PF800SH1L](#) [BLM41PG101SN1L](#) [DLW5AHN402SQ2L](#) [NFE31PT222Z1E9L](#)  
[NFE31PT471F1E9L](#) [NFE61HT332Z2A9L](#) [BLM21RK121SN1D](#) [BLM18HD102SN1D](#) [NFE61HT181C2A9L](#)  
[NFE61PT361B1H9L](#) [DLW5BSN152SQ2L](#) [DLW5BSN191SQ2L](#) [DLW5BSN102SQ2L](#) [DLW5BSN302SQ2L](#)  
[DLW21SN261SQ2L](#) [NFE31PT470C1E9L](#) [BLM21BD102SN1D](#) [BLM21BD222SN1L](#) [BLM21BB221SN1D](#)  
[BLM21AH601SN1D](#) [DLW5BSN351SQ2L](#) [BLM21PG220SN1D](#) [BLM21BB050SN1D](#) [BLM21BD272SN1L](#)  
[BLM31PG391SN1L](#) [BLM18HG471SN1D](#) [NFL18ST157X1C3D](#) [NFL18ST107X1C3D](#) [DLP31SN221SL2B](#)  
[DLP31SN221SL2L](#) [DLP31SN121SL2L](#) [BLM03AG121SN1D](#) [BLM21BD222SN1K](#) [DLP31DN441ML4L](#)  
[NFE61HT330U2A9L](#) [BLM21BB600SN1D](#) [BLM15AG102AN1D](#) [BLM15AG601AN1D](#) [BLM15EG121SN1D](#)  
[BLM15EG221SN1D](#) [BLM15HD102SN1D](#) [BLM15HD182SN1D](#) [BLM15HG102SN1D](#) [BLM15HG601SN1D](#)  
[BLM15PG100SN1D](#) [BLM18EG121SN1D](#) [BLM18EG221SN1D](#) [BLM18GG471SN1D](#) [BLM18PG221SN1D](#)  
[BLM18PG331SN1D](#) [BLM21AG331SN1J](#) [BLM21BD471SN1J](#) [NFE61HT102F2A9B](#) [DLP31DN471SL4L](#)  
[BLM18AG471SN1D](#) [BLM21PG331SN1D](#) [BLM41PG102SN1L](#) [BLM18BB220SN1D](#) [NFW31SP106X1E4L](#)