

SPECIFICATIONS

RoHS

Model Number: SU2B1
Part Number: 19028268A

Version: 07
Dec 22, 2017



Mechanical Drawing:

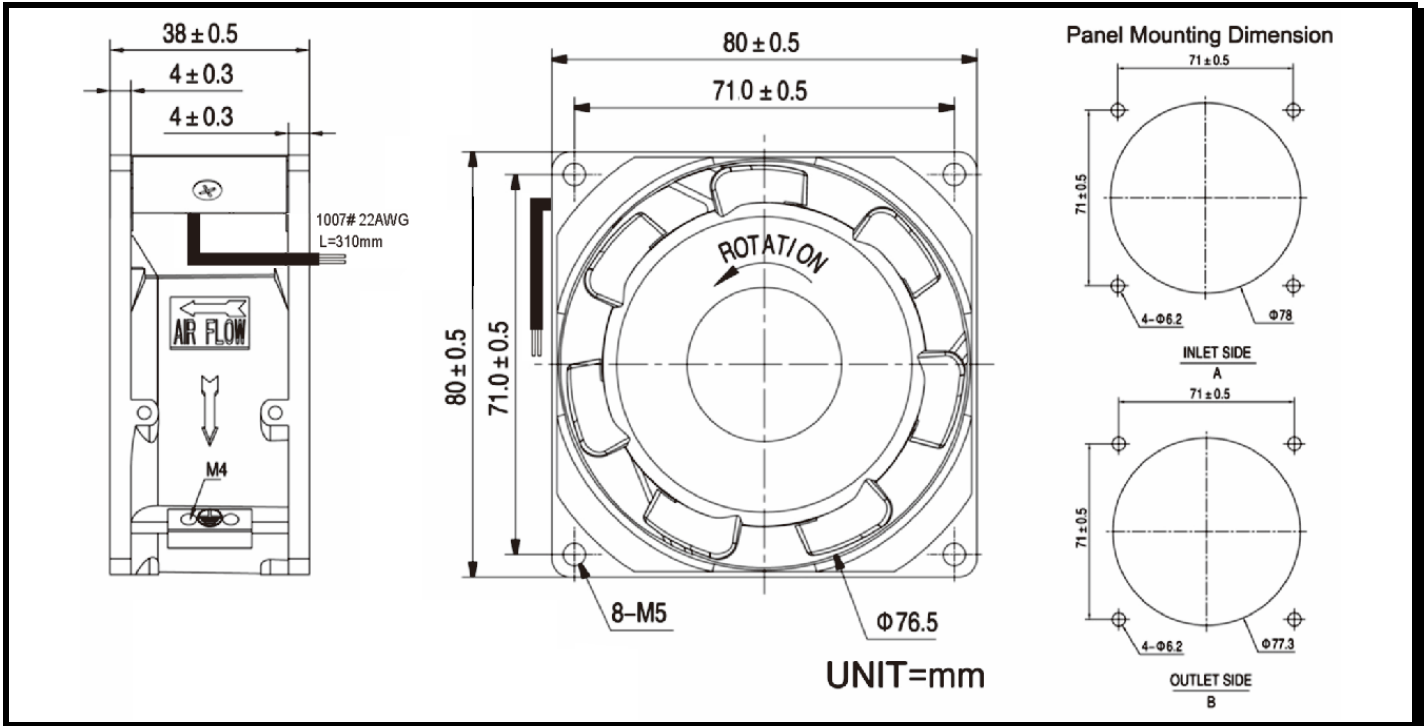

Motor:

Normal Voltage	= 115 VAC
Operating Voltage Range	= 99~121VAC
Operating Frequency	= 50/60Hz
Rated Current	= 0.14/0.13A
Input Power	= 15/13Watt
Average Speed	= 2380/2800RPM
Bearings	= Ball
Airflow	= 24/31CFM (Measuring at zero static pressure)
Static Pressure	= 0.13/0.17'' H ₂ O (Measuring at zero air flow)
Noise Level	= 30/32 dB(A)
Net Weight	= 260 gram.

Construction:

Venturi: High quality magnesium alloy die-casting frame with ED coating and powder coating, Black.
Propeller: Magnesium alloy with ED coating, Black

Life Expectancy:

This fan is designed for continuous duty life of 83,000 hours at 40°C

Additional Features:

Insulation Resistance: 100MΩ or more at 500 V megger.
Dielectric strength: 2 seconds at 1800 VAC/ 50-60 Hz.
Thermal Shock: Test per MIL-STD-202F, method 107G, condition D.
Operating Temperature: -10°C to 70°C
Storage Temperature: -40°C to 85°C

Termination:

See Mechanical Drawing.
Lead wire connection suit with 22AWG 1007#
Wire length=310±25.4mm

Agency Approvals:

UL, CUL, CE

PQ Curve:

