

The range of Vulcascot cable protectors are designed to prevent accidents and protect cables both for internal and external rugged applications.

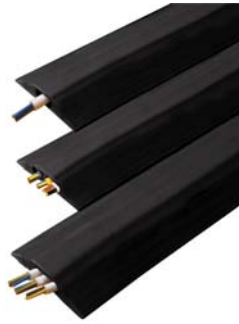

The Cable Protectors are Halogen Free and UV Stabilised. Non Conductive to BS903 - C5 500V, Fire Tested to BS476 Part 7 Class 3.

NATO codification numbers available for Defence Procurement on request.

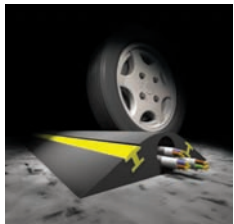
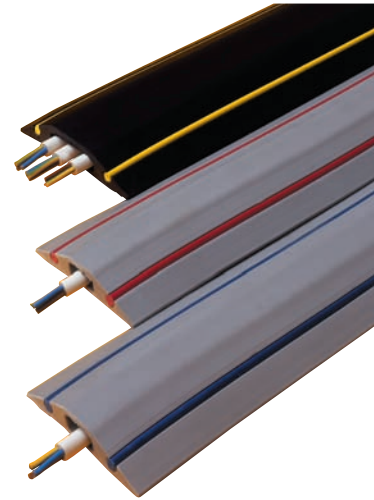

The Temporary Traffic Calmer range offers both cable protection and speed control, allowing the units to be moved and relaid with ease when required.

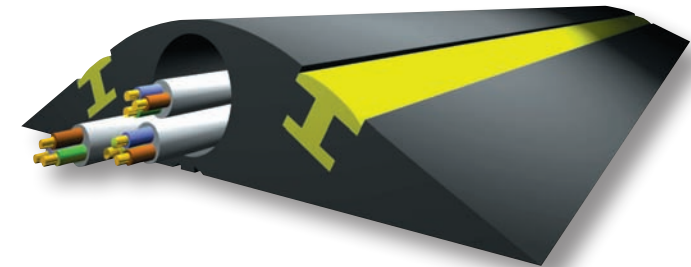

Vulcascot products are designed with low profile geometry. Cables can be inserted easily using the Snapfit, Snaptop, and cutting guides in the base of the Heavy Duty Cable Protectors.



Snap Fit and *Snap Top* for office and domestic use, Industrial sections for rugged outdoor and warehouse applications, *Temporary Traffic Calmers*, dual purpose cable protection and speed control.



VULCASCOT
CABLE PROTECTORS LTD

Unit 12, Norman-D-Gate
Bedford Road
Northampton
NN1 5NT

Tel: 0800 0352842
Fax: 01604 632344
International: +44 1604 212973

Email: sales@vulcascotcableprotectors.com
Web: www.vulcascotcableprotectors.com



VULCASCOT
CABLE PROTECTORS LTD

0800 0352842

Snap Fit™ Cable Protectors

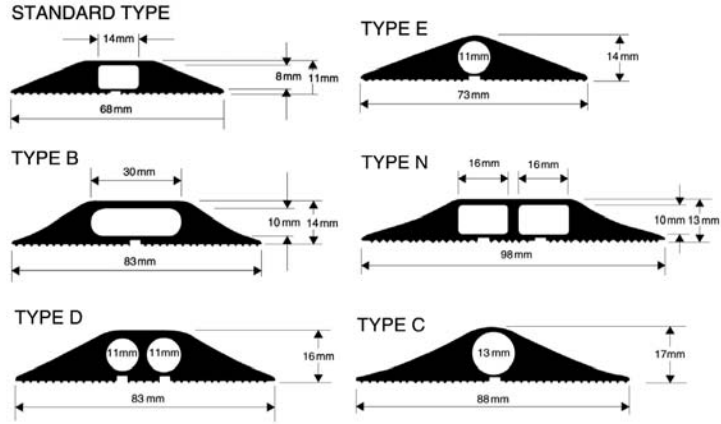

Industrial Cable Protectors

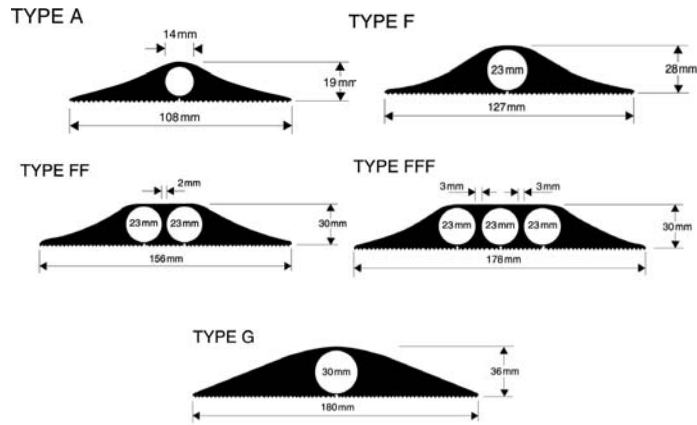

Hazard Warning™ Cable Protectors

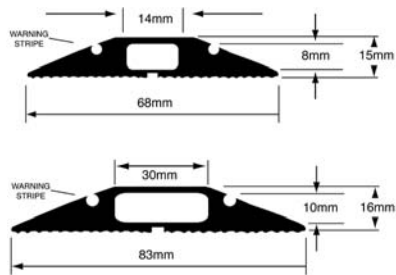

Snap Top™ Cable Protectors

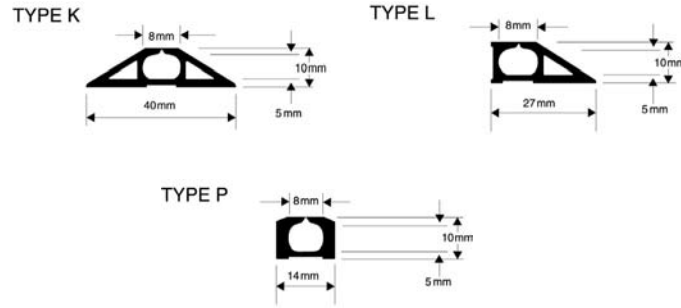

Multi Compartment Cable Protectors

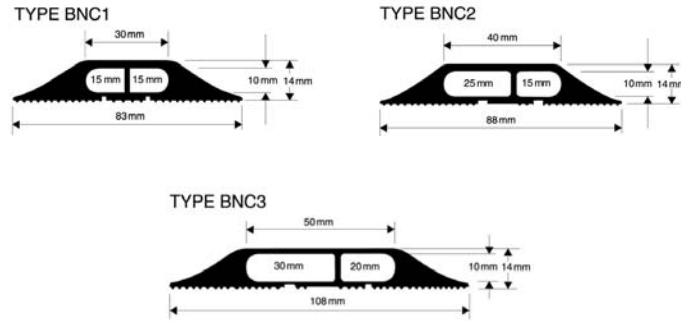

Snapfit Type MCP/1

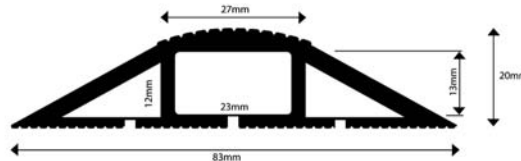

Snapfit Type MCP/2

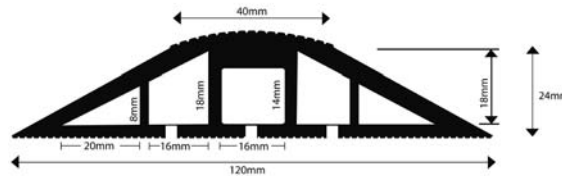

Traffic Calmers

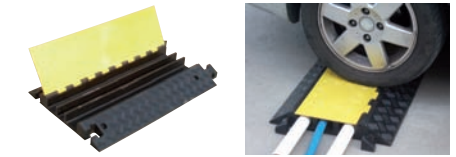

26400800

Temporary Traffic™ Calming Cable Protectors

TYPE TTC/1

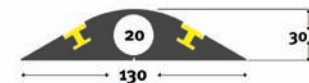

TYPE TTC/2

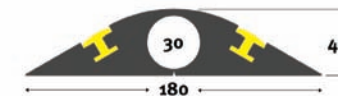

TYPE TTC/3

