

MBRS2535CT - MBR25150CT

25.0 AMPS. Surface Mount Schottky Barrier Rectifiers

D²PAK



Features

- ◇ UL Recognized File #E-326854
- ◇ For surface mounted application
- ◇ Plastic material used carriers Underwriters Laboratory Classsification 94V-0
- ◇ Metal to silicon junction, majority carrier conduction
- ◇ Low power loss, high efficiency
- ◇ High current capability, low forward voltage drop
- ◇ High surge current capability
- ◇ For use in low voltage, high frequency inverters, free wheeling, and polarity protection applications
- ◇ Guarding for overvoltage protection
- ◇ High temperature soldering guaranteed: 260°C/10s at terminals
- ◇ Green compound with suffix "G" on packing code & prefix "G" on datecode

Mechanical Data

- ◇ Case: JEDEC D²PAK Molded plastic
- ◇ Terminal: Pure tin plated, lead free, solderable per MIL-STD-750, Method 2026
- ◇ Polarity: As marked
- ◇ Mounting position: Any
- ◇ Mounting torque: 5 in.-lbs. max
- ◇ Weight: 1.37 gram

Maximum Ratings and Electrical Characteristics

Rating at 25 °C ambient temperature unless otherwise specified.
 Single phase, half wave, 60 Hz, resistive or inductive load.
 For capacitive load, derate current by 20%

Type Number	Symbol	MBRS 2535 CT	MBRS 2545 CT	MBRS 2550 CT	MBRS 2560 CT	MBRS 2590 CT	MBRS 25100 CT	MBRS 25150 CT	Unit
Maximum Repetitive Peak Reverse Voltage	V _{RRM}	35	45	50	60	90	100	150	V
Maximum RMS Voltage	V _{RMS}	24	31	35	42	63	70	105	V
Maximum DC Blocking Voltage	V _{DC}	35	45	50	60	90	100	150	V
Maximum Average Forward Rectified Current @ T _C =130°C	I _{F(AV)}	25							A
Peak Repetitive Forward Current (Rated V _R , Square Wave, 20KHz) at T _C =130°C	I _{FRM}	25							A
Peak Forward Surge Current, 8.3 ms Single Half Sine-wave Superimposed on Rated Load (JEDEC method)	I _{FSM}	200							A
Peak Reperitive Reverse Surge Current (Note 1)	I _{RRM}	1.0			0.5				A
Maximum Instantaneous Forward Voltage (Note 2) I _F =12.5A @ 25°C I _F =12.5A @ 125°C I _F =25.0A @ 25°C I _F =25.0A @ 125°C	V _F	0.60		0.75		0.85		0.95	V
Maximum Instantaneous Reverse Current T _A =25 °C at Rated DC Blocking Voltage Per Leg T _A =125 °C	I _R	0.2		0.2		0.1		0.1	mA
Voltage Rate of Change (Rated V _R)	dV/dt	10000							V/μS
Typical Thermal Resistance	R _{θJC}	1.0							°C/W
Operating Temperature Range	T _J	- 65 to + 150							°C
Storage Temperature Range	T _{STG}	- 65 to + 175							°C

Note 1: 2.0us Pulse Width, f=1.0KHz

Note 2: Pulse Test: 300us Pulse Width, 1% Duty Cycle

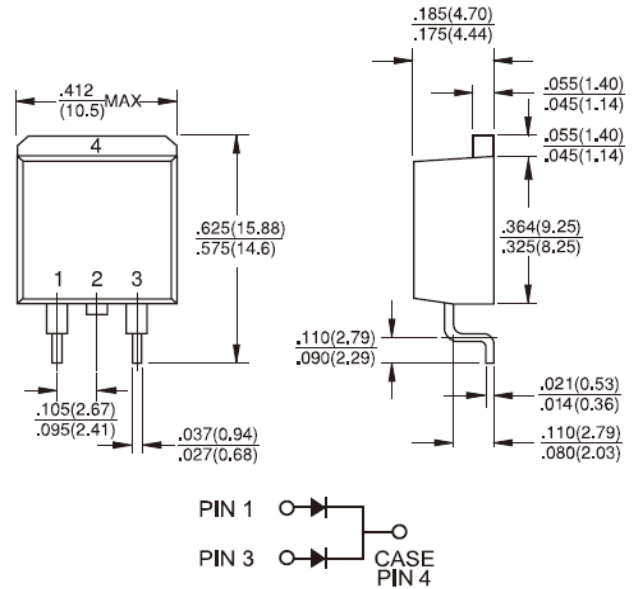

Dimensions in inches and (millimeters)

Marking Diagram



- MBRS25XXCT = Specific Device Code
 G = Green Compound
 Y = Year
 WW = Work Week

RATINGS AND CHARACTERISTIC CURVES (MBRS2535CT THRU MBRS25150CT)

FIG. 1 FORWARD CURRENT DERATING CURVE

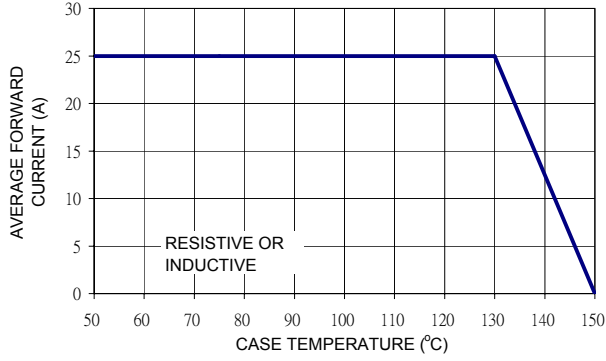

FIG. 2 MAXIMUM NON-REPETITIVE FORWARD SURGE CURRENT PER LEG

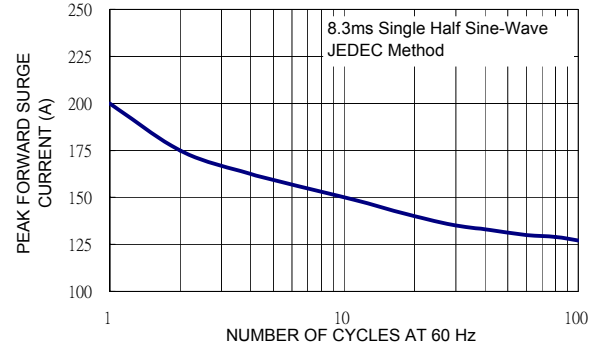

FIG. 3 TYPICAL FORWARD CHARACTERISTICS PER LEG

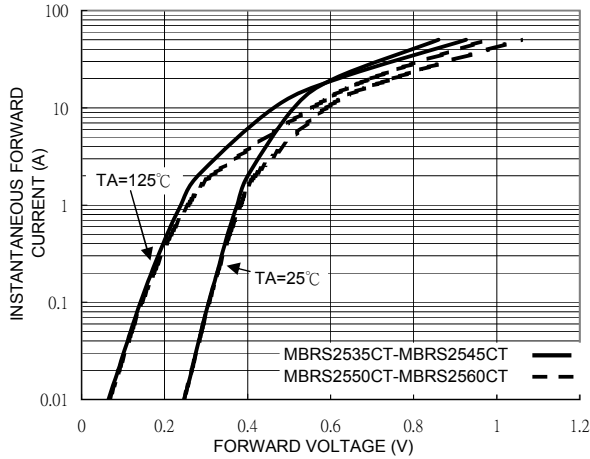

FIG. 4 TYPICAL FORWARD CHARACTERISTICS PER LEG

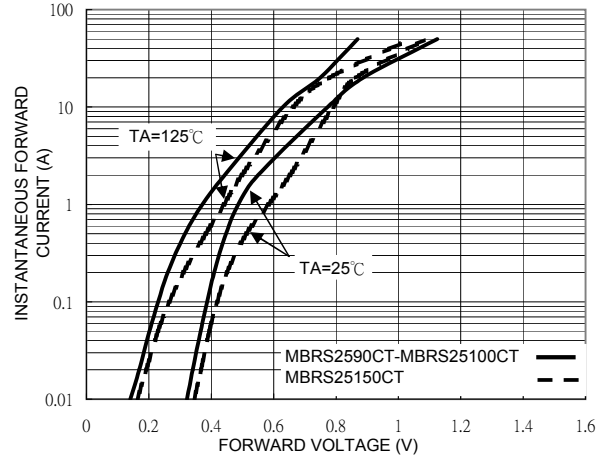

FIG. 5 TYPICAL REVERSE CHARACTERISTICS PER LEG

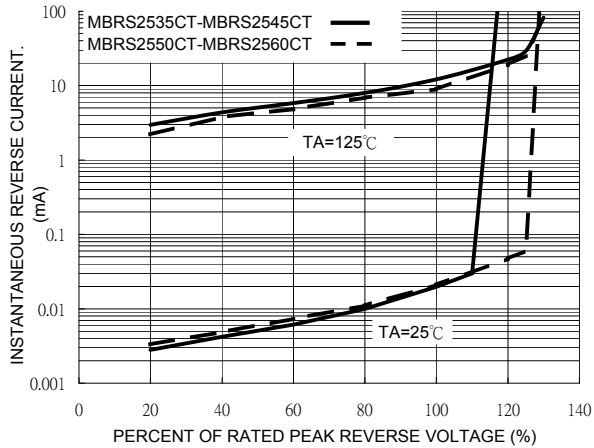
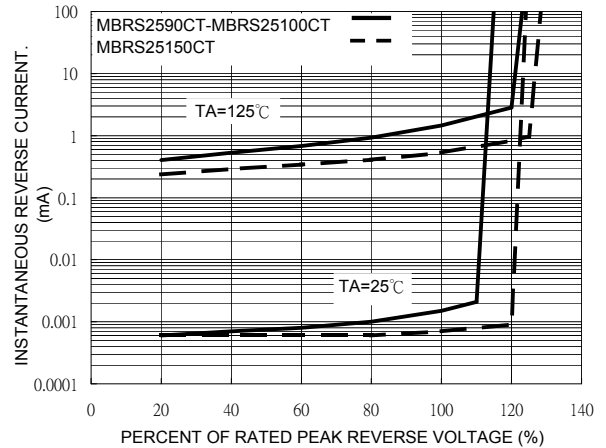

FIG. 6 TYPICAL REVERSE CHARACTERISTICS PER LEG



RATINGS AND CHARACTERISTIC CURVES (MBRS2535CT THRU MBRS25150CT)

FIG. 7 TYPICAL JUNCTION CAPACITANCE PER LEG

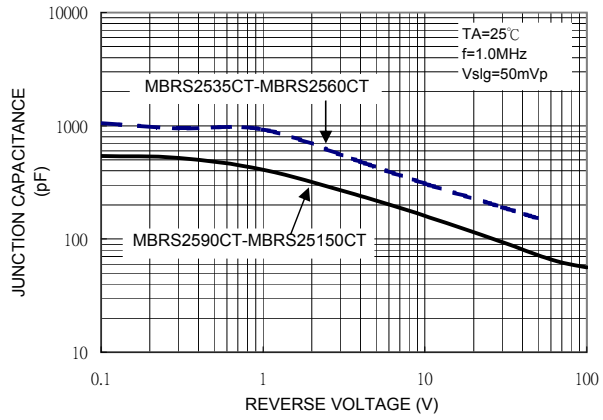

FIG. 8 TYPICAL TRANSIENT THERMAL IMPEDANCE PER LEG

