

# Cree® PLCC4 1-in-1 SMD LED CLA1A-WKW/MKW



## PRODUCT DESCRIPTION

SMD LEDs is packaged in the industry standard package. These LEDs have high reliability performance and are designed to work under a wide range of environmental conditions.

This high reliability feature makes them ideally suited to be used under illumination application conditions.

Its wide viewing angle makes these LEDs ideally suited for channel letter, or general backlighting and illumination applications. The flat top emitting surface makes it easy for these LEDs to mate with light pipes.

## FEATURES

- Size (mm): 3.2 x 2.8
- Color Temperatures(K):  
Cool White :  
Min . (4600) / Typical (5500)  
Warm White :  
Min . (2500) / Typical (3200)
- Luminous Intensity (mcd)  
CLA1A-WKW:  
(1800 - 4500)  
CLA1A-MKW:  
(1400 - 3550)
- CRI  
Typical CRI for Cool White is 72  
Typical CRI for Warm White is 80
- Viewing angle: 120 degree
- Lead-Free
- RoHS Compliant

## APPLICATIONS

- Light Strip
- Channel Letter

### ABSOLUTE MAXIMUM RATINGS ( $T_A = 25^\circ\text{C}$ )

Items	Symbol	Absolute Maximum Rating	Unit
Forward Current	$I_F$	35	mA
Peak Forward Current <sup>Note</sup>	$I_{FP}$	100	mA
Reverse Voltage	$V_R$	5	V
Power Dissipation	$P_D$	147	mW
Operation Temperature	$T_{opr}$	-40 ~ +100	$^\circ\text{C}$
Storage Temperature	$T_{stg}$	-40 ~ +100	$^\circ\text{C}$
Junction Temperature	$T_J$	110	$^\circ\text{C}$
Junction/Ambient	$R_{THJA}$	350	$^\circ\text{C/W}$
Junction/Solder Point	$R_{THJS}$	200	$^\circ\text{C/W}$

**Note:** Pulse width  $\leq 0.1$  msec, duty  $\leq 1/10$ .

### TYPICAL ELECTRICAL & OPTICAL CHARACTERISTICS ( $T_A = 25^\circ\text{C}$ )

Characteristics	Color	Symbol	Condition	Unit	Minimum	Typical	Maximum
Forward Voltage	Cool/Warm	$V_F$	$I_F = 30$ mA	V		3.6	4.2
Reverse Current	Cool/Warm	$I_R$	$V_R = 5$ V	$\mu\text{A}$			10
Luminous Flux	Cool	$\Phi_V$	$I_F = 30$ mA	mlm		7000	
	Warm	$\Phi_V$	$I_F = 30$ mA	mlm		6000	
Luminous Intensity	Cool	$I_V$	$I_F = 30$ mA	mcd	1800	2800	
	Warm	$I_V$	$I_F = 30$ mA	mcd	1400	2500	
Chromaticity Coordinates	Cool	x	$I_F = 30$ mA			0.3325	
		y	$I_F = 30$ mA			0.3411	
	Warm	x	$I_F = 30$ mA			0.4234	
		y	$I_F = 30$ mA			0.3990	
50% Power Angle	Cool/Warm	$2\theta_{1/2}$	$I_F = 30$ mA	deg		120	

### INTENSITY BIN LIMIT ( $I_f = 30 \text{ mA}$ )

#### Cool White(CLA1A-WKW)

Bin Code	Min.(mcd)	Max.(mcd)
Xa	1800	2240
Xb	2240	2800
Ya	2800	3550
Yb	3550	4500

#### Warm White (CLA1A-MKW)

Bin Code	Min.(mcd)	Max.(mcd)
Wb	1400	1800
Xa	1800	2240
Xb	2240	2800
Ya	2800	3550

Tolerance of measurement of luminous intensity is  $\pm 10\%$ .

### VF BIN LIMIT ( $I_f = 30 \text{ mA}$ )

#### Cool White (CLA1A-WKW)

Bin Code	Min.(V)	Max.(V)
27	2.8	3.0
28	3.0	3.2
29	3.2	3.4
2a	3.4	3.6
2b	3.6	3.8
2c	3.8	4.0
2d	4.0	4.2

#### Warm White (CLA1A-MKW)

Bin Code	Min.(V)	Max.(V)
27	2.8	3.0
28	3.0	3.2
29	3.2	3.4
2a	3.4	3.6
2b	3.6	3.8
2c	3.8	4.0
2d	4.0	4.2

Tolerance of measurement of VF is  $\pm 0.05\text{V}$ .

**COLOR BIN LIMIT ( $I_f = 30 \text{ mA}$ )**

Cool White

Bin Code	Sub-bin	x	y
W1	Wa	0.2545	0.2480
		0.2633	0.2410
		0.2545	0.2245
		0.2450	0.2290
	Wb	0.2633	0.2410
		0.2720	0.2340
		0.2640	0.2200
		0.2545	0.2245
	Wc	0.2545	0.2480
		0.2640	0.2670
		0.2720	0.2575
		0.2633	0.2410
	Wd	0.2633	0.2410
		0.2720	0.2575
		0.2800	0.2480
		0.2720	0.2340
W2	We	0.2640	0.2670
		0.2735	0.2860
		0.2808	0.2740
		0.2720	0.2575
	Wf	0.2720	0.2575
		0.2808	0.2740
		0.2880	0.2620
		0.2800	0.2480
	Wg	0.2735	0.2860
		0.2830	0.3050
		0.2895	0.2905
		0.2808	0.2740
	Wh	0.2808	0.2740
		0.2895	0.2905
		0.2960	0.2760
		0.2880	0.2620

Bin Code	Sub-bin	x	y
W3	Wj	0.2830	0.3050
		0.2950	0.3210
		0.2998	0.3028
		0.2895	0.2905
	Wk	0.2895	0.2905
		0.2998	0.3028
		0.3045	0.2865
		0.2960	0.2760
	Wm	0.2950	0.3210
		0.3070	0.3370
		0.3100	0.3150
		0.2998	0.3028
	Wn	0.2998	0.3028
		0.3100	0.3150
		0.3130	0.2970
		0.3045	0.2865
W4	Wp	0.3070	0.3370
		0.3185	0.3485
		0.3200	0.3270
		0.3100	0.3150
	Wq	0.3100	0.3150
		0.3200	0.3270
		0.3215	0.3075
		0.3130	0.2970
	Wr	0.3185	0.3485
		0.3300	0.3600
		0.3300	0.3390
		0.3200	0.3270
	Ws	0.3200	0.3270
		0.3300	0.3390
		0.3300	0.3180
		0.3215	0.3075

Bin Code	Sub-bin	x	y
W5	Wt	0.3300	0.3600
		0.3455	0.3725
		0.3443	0.3535
		0.3300	0.3390
	Wu	0.3300	0.3390
		0.3443	0.3535
		0.3430	0.3345
		0.3300	0.3180
	Wv	0.3455	0.3725
		0.3610	0.3850
		0.3585	0.3680
		0.3443	0.3535
	Ww	0.3443	0.3535
		0.3585	0.3680
		0.3560	0.3510
		0.3430	0.3345

Tolerance of measurement of the color coordinates is  $\pm 0.01$ .

**COLOR BIN LIMIT ( $I_f = 30 \text{ mA}$ )**

Warm White

Bin Code	Sub-bin	x	y
M1	Ma	0.3610	0.3900
		0.3576	0.3651
		0.3751	0.3783
		0.3820	0.4075
	Mb	0.3576	0.3651
		0.3541	0.3401
		0.3682	0.3491
		0.3749	0.3781
	Mc	0.3820	0.4075
		0.3751	0.3783
		0.3926	0.3915
		0.4030	0.4250
	Md	0.3751	0.3783
		0.3682	0.3491
		0.3822	0.3580
		0.3926	0.3915

Bin Code	Sub-bin	x	y
M2	Me	0.4030	0.4250
		0.3926	0.3915
		0.4118	0.4021
		0.4260	0.4390
	Mf	0.3926	0.3915
		0.3822	0.3580
		0.3976	0.3653
		0.4118	0.4021
	Mg	0.4260	0.4390
		0.4118	0.4021
		0.4310	0.4128
		0.4490	0.4530
	Mh	0.4118	0.4021
		0.3976	0.3653
		0.4129	0.3725
		0.4310	0.4128

Bin Code	Sub-bin	x	y
M3	Mj	0.4490	0.4530
		0.4310	0.4128
		0.4572	0.4203
		0.4785	0.4625
	Mk	0.4310	0.4128
		0.4129	0.3726
		0.4359	0.3782
		0.4572	0.4203
	Mm	0.4785	0.4625
		0.4572	0.4203
		0.4834	0.4279
		0.5080	0.4720
	Mn	0.4572	0.4203
		0.4359	0.3782
		0.4588	0.3838
		0.4834	0.4279

Tolerance of measurement of the color coordinates is  $\pm 0.01$ .

### CIE CHROMATICITY DIAGRAM

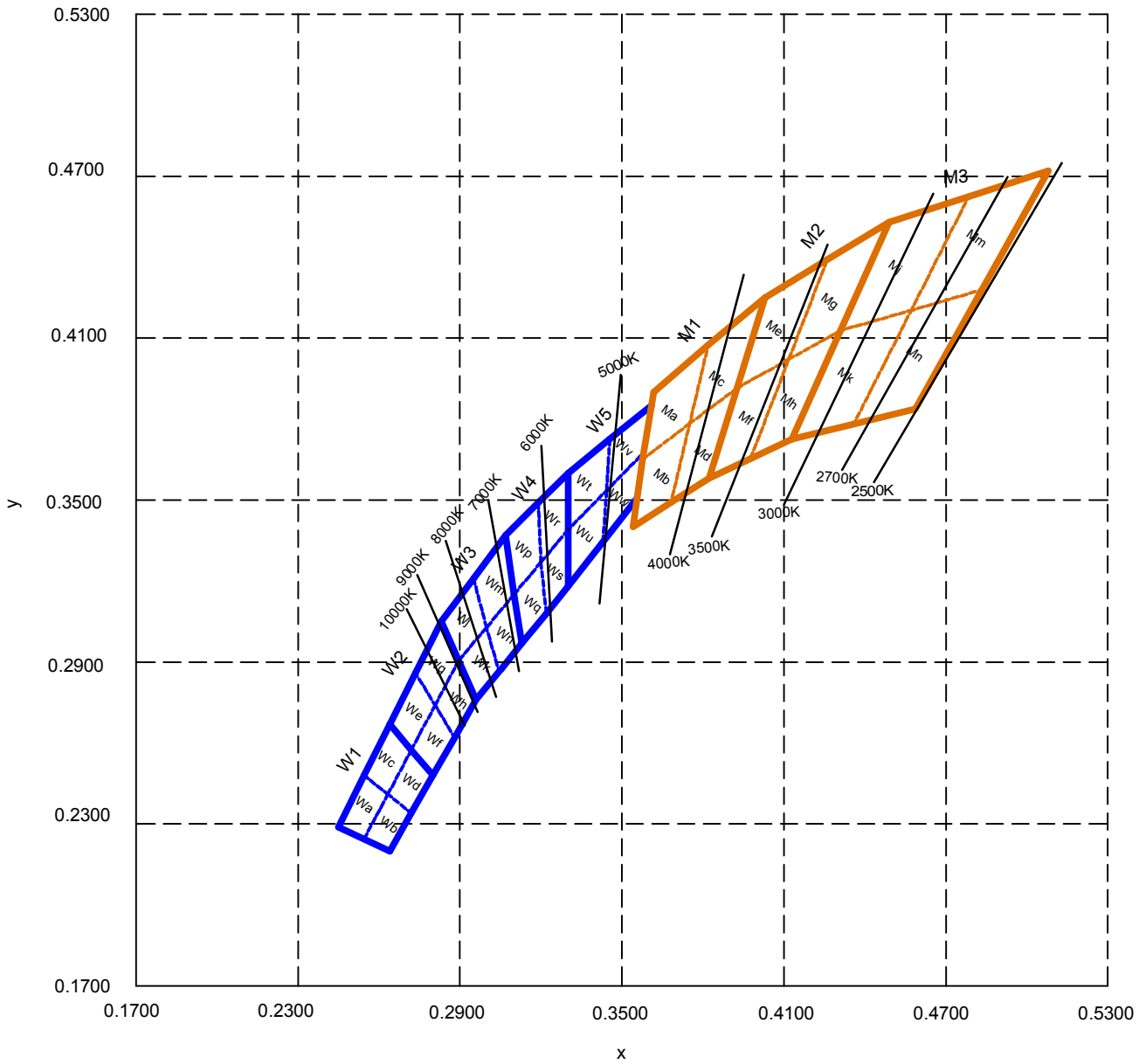

**ORDER CODE TABLE\***

Color	Kit Number	Viewing Angle	Luminous Intensity (mcd)		Color Bin Code
			Min.	Max.	
Cool White	CLA1A-WKW-CXaYb153	120	1800	4500	W1,W2,W3,W4,W5
Cool White	CLA1A-WKW-CXaYb453	120	1800	4500	W4,W5
Cool White	CLA1A-WKW-CXbYb453	120	2240	4500	W4,W5

Color	Kit Number	Viewing Angle	Luminous Intensity (mcd)		Color Bin Code
			Min.	Max.	
Warm White	CLA1A-MKW-CWbYa133	120	1400	3550	M1,M2,M3
Warm White	CLA1A-MKW-CWbYa513	120	1400	3550	W5,M1
Warm White	CLA1A-MKW-CWbYa233	120	1400	3550	M2,M3
Warm White	CLA1A-MKW-CXaYa233	120	1800	3550	M2,M3
Warm White	CLA1A-MKW-CXaYa513	120	1800	3550	W5,M1

Notes:

1. The above kit numbers represent order codes that include multiple intensity-bin and color-bin codes. Only one intensity-bin code and one color-bin code will be shipped on each bulk. Single intensity-bin code and single color-bin codes will not be orderable.
2. Please refer to the "Cree LED Lamp Reliability Test Standards" document for reliability test conditions.
3. Please refer to the "Cree LED Lamp Soldering & Handling" document for information about how to use this LED product safely.

GRAPHS

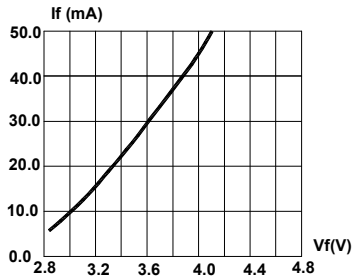

FIG.1 FORWARD CURRENT VS. FORWARD VOLTAGE.

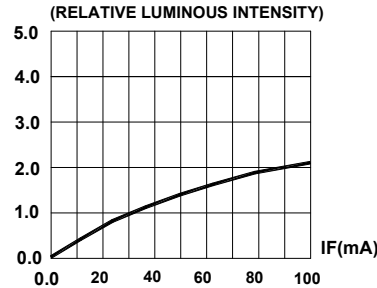

FIG.2 RELATIVE LUMINOUS INTENSITY VS. FORWARD CURRENT

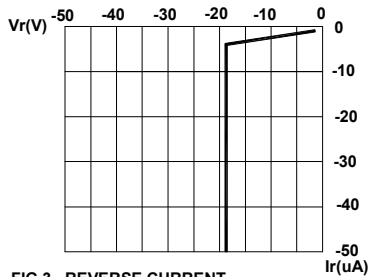

FIG.3 REVERSE CURRENT VS. REVERSE VOLTAGE.

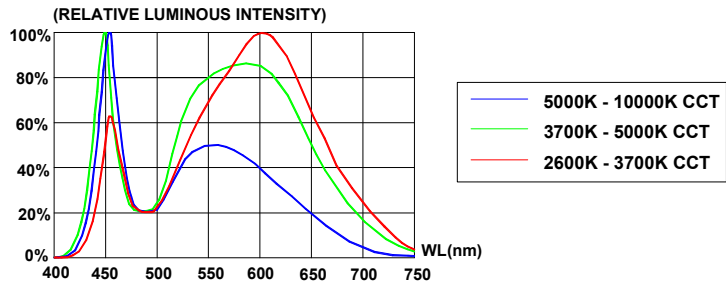

FIG.4 RELATIVE LUMINOUS INTENSITY VS. WAVELENGTH.

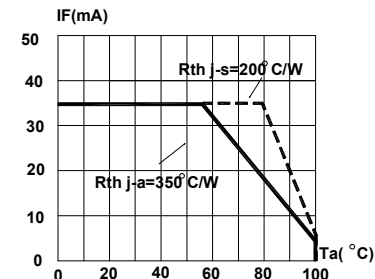

FIG.5 MAXIMUM FORWARD DC CURRENT VS AMBIENT TEMPERATURE ( $T_{jmax}=110^{\circ}C$ )

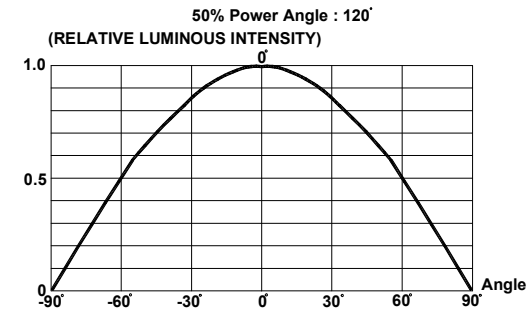

FIG.6 FAR FIELD PATTERN

The above data are collected from statistical figures that do not necessarily correspond to the actual parameters of each single LED. Hence, these data will be changed without further notice.



## MECHANICAL DIMENSIONS

All dimensions are in mm.

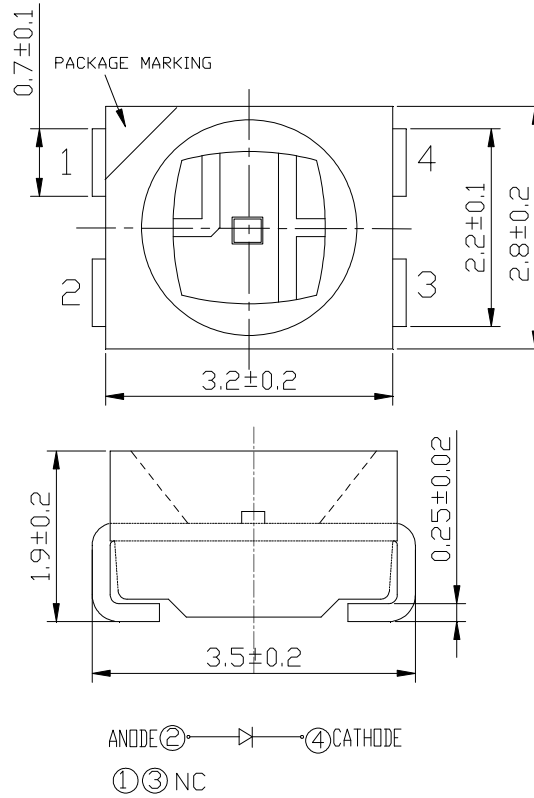

## NOTES

### RoHS Compliance

The levels of environmentally sensitive, persistent biologically toxic (PBT), persistent organic pollutants (POP), or otherwise restricted materials in this product are below the maximum concentration values (also referred to as the threshold limits) permitted for such substances, or are used in an exempted application, in accordance with EU Directive 2002/95/EC on the restriction of the use of certain hazardous substances in electrical and electronic equipment (RoHS), as amended through April 21, 2006.

### Vision Advisory Claim

Users should be cautioned not to stare at the light of this LED product. The bright light can damage the eye.

**KIT NUMBER SYSTEM**

Cree LED lamps are tested and sorted into performance bins. A bin is specified by ranges of color, forward voltage, and brightness. Sorted LEDs are packaged for shipping in various convenient options. Please refer to the "Cree LED Lamp Packaging Standard" document for more information about shipping and packaging options.

Cree LEDs are sold by order codes in combinations of bins called kits. Order codes are configured in the following manner:



## PACKAGING

- The boxes are not water resistant and they must be kept away from water and moisture.
- The LEDs are packed in cardboard boxes after packaging in normal or anti-electrostatic bags.
- Cardboard boxes will be used to protect the LEDs from mechanical shocks during transportation.
- The reel pack is applied in SMD LED.
- Max 2000 pcs per reel.

