

SERIES 1005 - MINIATURE SNAP-ACTION SWITCHES

T0 21 (8) A 250 V AC



PRODUCT FEATURES

- ◆ Friction contact system whose shearing movement can loosen weldings
- ◆ Very high inrush currents (capacitive)
- ◆ Contact distances less and greater than 3 mm
- ◆ Operating forces from 0.2 to 4.2 N

ON REQUEST

- ◆ Material conform with the filament wire test acc. to IEC 60335-1:2001 chap. 30
- ◆ Side bearing terminal
- ◆ Electrical rating 16 (16) A 250 V 5E4 for normally closed and normally open version

Design	DIN 41635 A
Mechanical life endurance	5E6 version with lever or contact spacing > 3 mm 10E6 standard version 5E4 version with curved spring steel lever
Contact resistance (new condition)	< 100 mOhm (1 A 12 V DC)
Insulation resistance (new condition)	> 100 MOhm (500 V DC)
Proof tracking	250 PTI
Ambient temperature	-40 °C ... +100 °C on request ... +125 °C ... +85 °C
Flammability	UL 94 (housing: V-0, actuator: V-2) UL 94 V-2
Glow wire test temperature	850 °C
Material	actuator PA additional actuator galvanized steel / spring steel / stainless steel housing Duroplast type 182 / PA glass fiber-reinforced terminals silver plated / chromated
Bounce time	< 10 ms
Approval marks	UL / CE / RoHS
Suitable for appliances of protection class II under compliance with the installation conditions required on the equipment side	



SERIES 1005 - MINIATURE SNAP-ACTION SWITCHES



























TO 21 (8) A 250 V AC



	Normally closed contact (SPNC)			Normally open contact (SPNO)			Changeover switch (SPDT momentary)							
	1005.1105	1005.1101	1006.3402	1005.2809	1005.1207	1005.1226	1005.2505	1005.0904	1005.1204	1005.1201	1005.4001	1005.0404	1005.1004	1006.1514
21 (8) A 250 V AC 25E3				●										
20 (4) A 400 V AC 1E4					●							●	●	●
16 (16) A 250 V AC 5E4						●								
16 (4) A 400 V AC 5E4					●							●	●	●
16 (4) A 250 V AC 5E4				●										
16 (4) A 250 V AC 25E3							●							
12 (12) A 250 V AC 5E4														
10 (6) A 250 V AC 5E4	●				●			●	●			●	●	●
10 (4) A 400 V AC 1E4		●								●	●			
10 (4) A 250 V AC 5E4			●											
8 (8) A 250 V AC 5E4				●										
6 (2.5) A 400 V AC 5E4		●								●	●			
6 (2.5) A 250 V AC 5E4			●											
21 A 250 V AC 2 HP				●										
21 A 125 V AC 1 HP				●										
16 A 250 V AC 2 HP					●									
16 A 125 V AC 1 HP					●	●								
16 A 125 - 250 V AC 1/2 HP					●		●					●	●	●
10 A 125 - 250 V AC 1/2 HP	●							●	●					
10 A 125 - 250 V AC 1/4 HP		●	●							●	●			
8 A 125 - 250 V AC 1/3 HP														
4 A 125 - 250 V AC 1/6 HP														
Terminal type														
Terminal description		6.3	6.3		4.8 top side	6.3	6.3 straight	4.8 straight	6.3	6.3	6.3	6.3	6.3	6.3
Contact distance in mm		> 3	< 3		> 3	< 3	< 3	> 3	> 3	< 3	< 3	< 3	< 3	< 3
Contact material		Ag	Ag		Ag	Ag	Ag	Ag	Ag	Ag	Ag	Ag	Ag	Ag
Operating force in N		2.6 - 4.2	1.5 - 2.5		2.4 - 3.8	2.4 - 3.8	2.4 - 3.8	3.5 - 4.9	2.4 - 3.8	2.4 - 3.8	1.5 - 2.5	2.4 - 3.8	2.4 - 3.8	1.2 - 2.1
Operating position (OP) in mm		14.6±0.4	14.8±0.4		14.5±0.3	14.7±0.5	14.7±0.5	14.4±0.3	14.4±0.3	14.7±0.5	14.7±0.5	14.7±0.5	14.7±0.5	20.8±1.2
Difference travel max. in mm		1.0	0.3		1.2	0.3	0.3	1.2	1.2	0.3	0.3	0.3	0.3	0.9
Free position (FP) max. in mm		13.4 16	13.4 16		13.4 16	13.4 16	13.4 16	13.4 16	13.4 16	13.4 16	13.4 16	13.4 16	13.4 16	18 23.5
Permissible total travel position (TP) in mm		13.4 16	13.4 16		13.4 16	13.4 16	13.4 16	13.4 16	13.4 16	13.4 16	13.4 16	13.4 16	13.4 16	18 23.5
Actuator description														
Lever drawing			L21										L12	
Miscellaneous														
Stock version	●	●			●				●			●	●	









SERIES 1005 - MINIATURE SNAP-ACTION SWITCHES

TO 21 (8) A 250 V AC

	Changeover switch (SPDT momentary)															
	1005.0507	1005.1010	1004.0509	1005.0101	1005.0401	1005.1001	1005.3501	1006.0701	1006.0901	1006.1101	1006.1201	1006.1301	1006.1401	1006.1511	1006.1801	1006.4103
																
21 (8) A 250 V AC 25E3																
20 (4) A 400 V AC 1E4																
16 (16) A 250 V AC 5E4																
16 (4) A 400 V AC 5E4	●	●														
16 (4) A 250 V AC 5E4																
16 (4) A 250 V AC 25E3			●													
12 (12) A 250 V AC 5E4																
10 (6) A 250 V AC 5E4	●															
10 (4) A 400 V AC 1E4				●	●	●	●	●	●	●	●	●	●	●	●	●
10 (4) A 250 V AC 5E4			●													
8 (8) A 250 V AC 5E4		●														
6 (2.5) A 400 V AC 5E4				●	●	●	●	●	●	●	●	●	●	●	●	●
6 (2.5) A 250 V AC 5E4																
21 A 250 V AC 2 HP																
21 A 125 V AC 1 HP																
16 A 250 V AC 2 HP																
16 A 125 V AC 1 HP																
16 A 125 - 250 V AC 1/2 HP	●		●													
10 A 125 - 250 V AC 1/2 HP		●														
10 A 125 - 250 V AC 1/4 HP				●	●	●	●	●	●	●	●	●	●	●	●	●
8 A 125 - 250 V AC 1/3 HP																
4 A 125 - 250 V AC 1/6 HP																
Terminal type																
Terminal description		6.3		M3		6.3				6.3		6.3	6.3	6.3	6.3	
Contact distance in mm	< 3	> 3	< 3	< 3	< 3	< 3	< 3	< 3	< 3	< 3	< 3	< 3	< 3	< 3	< 3	< 3
Contact material	Ag	Ag	Ag	Ag	Ag	Ag	Ag	Ag	Ag	Ag	Ag	Ag	Ag	Ag	Ag	Ag
Operating force in N	2.4 - 3.8	2.4 - 3.8	0.8 - 1.8	1.5 - 2.5	1.5 - 2.5	1.5 - 2.5	1.5 - 2.5	1.5 - 2.5	0.8 - 1.4	1.5 - 2.5	1.5 - 2.5	0.3 - 0.55	0.8 - 1.4	0.7 - 1.25	1.5 - 2.5	1.5 - 2.5
Operating position (OP) in mm	14.7±0.5	14.4±0.3	14.7±0.5	14.7±0.5	14.7±0.5	14.7±0.5	14.7±0.5	20.8±0.5	15.4±1.2	15.3±0.5	20.8±0.5	15.7±2.7	15.4±1.2	20.8±1.2	22±1	20.8±0.5
Difference travel max. in mm	0.3	1.2	0.1 - 0.25	0.3	0.3	0.3	0.3	0.3	0.7	0.3	0.3	1.8	0.7	0.9	0.6	0.3
Free position (FP) max. in mm	13.4 16	13.4 16	13.4 16	13.4 16	13.4 16	13.4 16	13.4 16	19.5 22.1	12.6 18.2	14 16.6	19.5 22.1	9.8 21.5	12.6 18.2	18 23.5	18.5 24.5	19.5 22.1
Permissible total travel position (TP) in mm	13.4 16	13.4 16	13.4 16	13.4 16	13.4 16	13.4 16	13.4 16	19.5 22.1	12.6 18.2	14 16.6	19.5 22.1	9.8 21.5	12.6 18.2	18 23.5	18.5 24.5	19.5 22.1
Actuator description	□	□	□	□	□	□	□									
Lever drawing								L11	L02	L01	L11	L04	L02	L12	L31	L11
Miscellaneous			milled bearing blade													
Stock version				●	●	●		●			●	●	●	●	●	

SERIES 1005 - MINIATURE SNAP-ACTION SWITCHES

TO 21 (8) A 250 V AC

	Changeover switch (SPDT momentary)	1006.4203	1004.4601	1004.0402	1004.1002
					
21 (8) A 250 V AC 25E3					
20 (4) A 400 V AC 1E4					
16 (16) A 250 V AC 5E4					
16 (4) A 400 V AC 5E4					
16 (4) A 250 V AC 5E4					
16 (4) A 250 V AC 25E3					
12 (12) A 250 V AC 5E4					
10 (6) A 250 V AC 5E4					
10 (4) A 400 V AC 1E4		●			
10 (4) A 250 V AC 5E4			●		
8 (8) A 250 V AC 5E4					
6 (2.5) A 400 V AC 5E4		●			
6 (2.5) A 250 V AC 5E4				●	●
21 A 250 V AC 2 HP					
21 A 125 V AC 1 HP					
16 A 250 V AC 2 HP					
16 A 125 V AC 1 HP					
16 A 125 - 250 V AC 1/2 HP					
10 A 125 - 250 V AC 1/2 HP					
10 A 125 - 250 V AC 1/4 HP		●			
8 A 125 - 250 V AC 1/3 HP			●		
4 A 125 - 250 V AC 1/6 HP				●	●
Terminal type					
Terminal description			6.3		6.3
Contact distance in mm		< 3	< 3	< 3	< 3
Contact material		Ag	Ag	Ag	Ag
Operating force in N		1.5 - 2.5	0.5 - 1.1	0.2 - 0.6	0.2 - 0.6
Operating position (OP) in mm		20.8 ± 0.5	20.8 ± 0.5	14.7 ± 0.5	14.7 ± 0.5
Difference travel max. in mm		0.3	0.3	0.3	0.3
Free position (FP) max. in mm		19.5 22.1	19.5 22.1	13.4 16	13.4 16
Permissible total travel position (TP) in mm		19.5 22.1	19.5 22.1	13.4 16	13.4 16
Actuator description					
Lever drawing		L11	L11		
Miscellaneous			milled bearing blade	milled bearing blade	milled bearing blade
Stock version				●	●

ROCKER SWITCHES

PUSHBUTTON SWITCHES

TOGGLE SWITCHES

SLIDE SWITCHES

ROTARY SWITCHES

FOOT SWITCHES

FACT AND KEY SWITCHES

SNAP-ACTION SWITCHES

MICRO-SIGNAL SWITCHES

SENSORS

SERIES 1005 - MINIATURE SNAP-ACTION SWITCHES

TO 21 (8) A 250 V AC

ROCKER SWITCHES

PUSHBUTTON SWITCHES

TOGGLE SWITCHES

SLIDE SWITCHES

ROTARY SWITCHES

FOOT SWITCHES

TAPE AND KEY SWITCHES

SNAP-ACTION SWITCHES

MICRO-SIGNAL SWITCHES

SENSORS



Basic type 1005

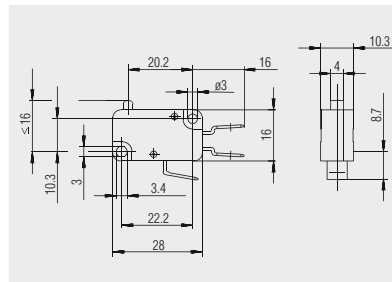

Quick-connect terminal 6.3 x 0.8

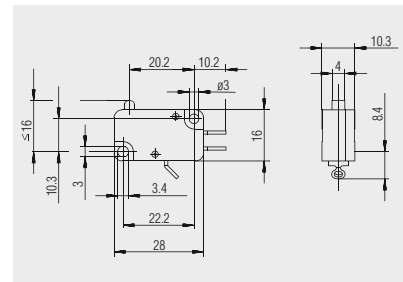

Solder terminal

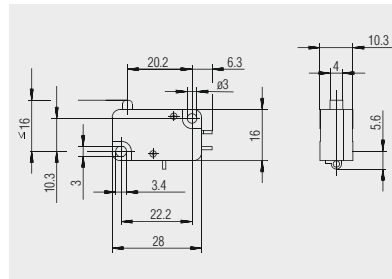

Short solder terminal

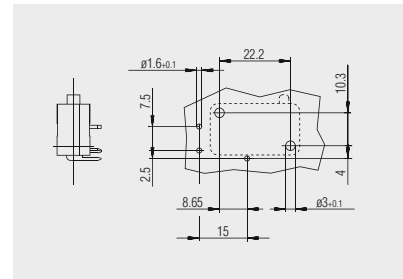

PCB terminal (cover side)
right angled

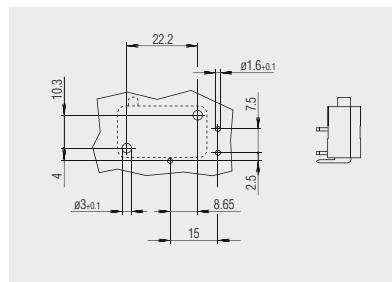

PCB terminal (base side)
left angled

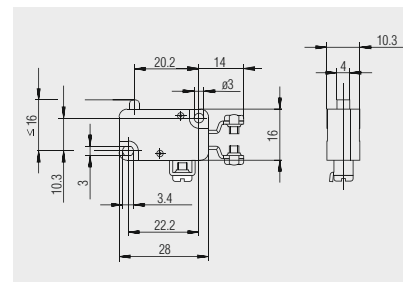

Screw terminal M3



Basic type 1005

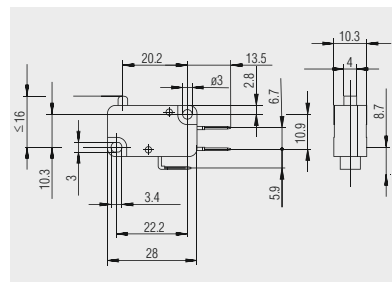

Quick-connect terminal 4.8 x 0.8
straight

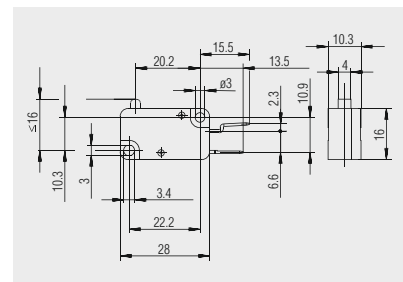

Quick-connect terminal 4.8 x 0.8
top side

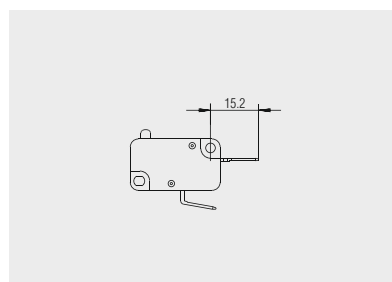

Quick-connect terminal 6.3 x 0.8
normally open contact version

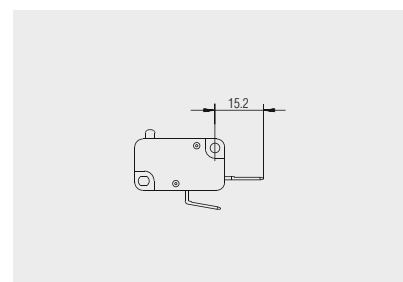

Quick-connect terminal 6.3 x 0.8
normally closed contact version

SERIES 1005 - MINIATURE SNAP-ACTION SWITCHES

TO 21 (8) A 250 V AC



Basic types 1004 and 1005
switching positions

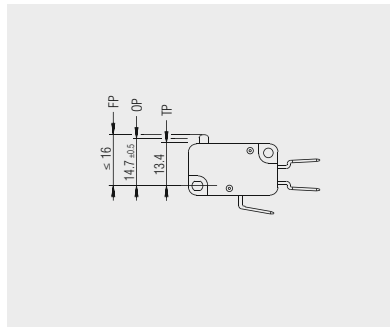

FP: free position
OP: operating position
TP: permissible total travel position



Basic type 1006
auxiliary actuator

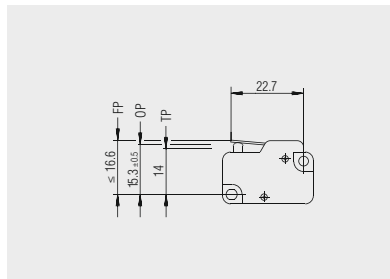

L01: straight lever

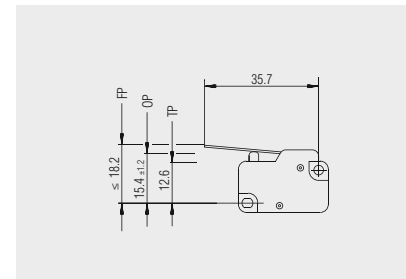

L02: straight lever

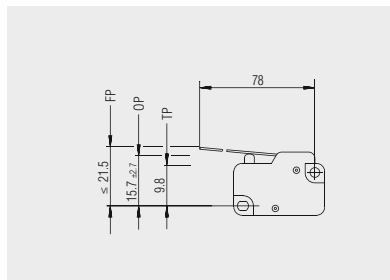

L04: straight lever

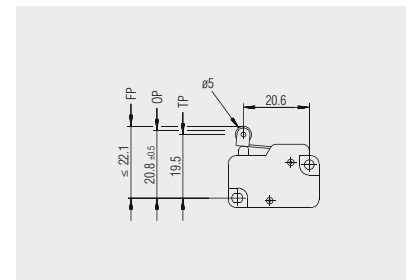

L11: roller lever

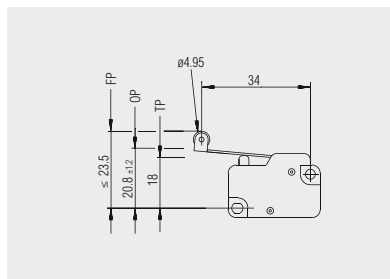

L12: roller lever

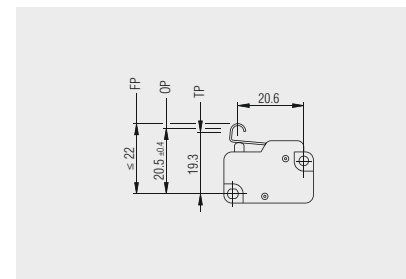

L21: simulated roller

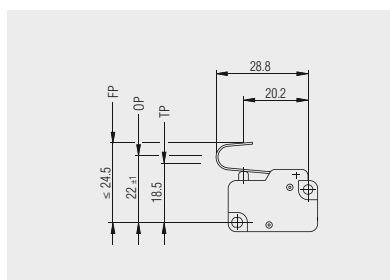

L31: spring lever

ROCKER SWITCHES

PUSHBUTTON SWITCHES

TOGGLE SWITCHES

SLIDE SWITCHES

ROTARY SWITCHES

FOOT SWITCHES

FACT AND KEY SWITCHES

SNAP-ACTION SWITCHES

MICRO-SIGNAL SWITCHES

SENSORS

SERIES 1005 - MINIATURE SNAP-ACTION SWITCHES

TO 21 (8) A 250 V AC



Additional parts

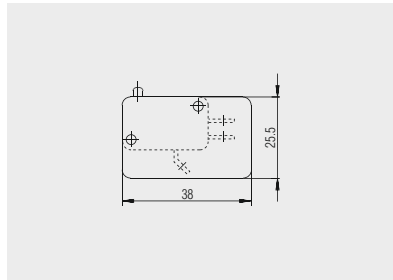

Insulating plate for solder terminal
0.5 mm: 231.009.011

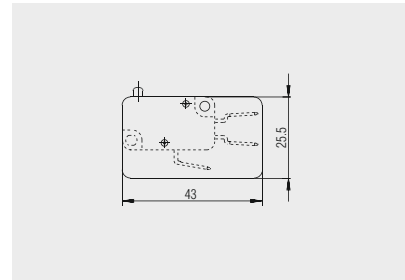

Insulating plate for quick-connect terminal
0.5 mm: 231.010.011
0.8 mm: 231.010.021

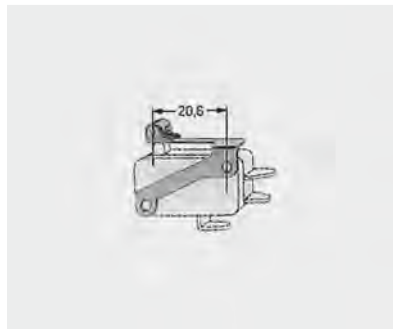

Stainless spring steel





lever 20.6 long with roller diameter 5
out of PA yellow (to be mounted lateral
with the switch using screws)

191.013.013













Further information under

WWW.MARQUARDT-SWITCHES.COM

















APPROVAL MARKS

	ENEC 05 (KEMA)		UL (USA)
	ENEC 10 (VDE)		UL (USA + Canada)
	VDE		CSA (Canada)
			CSA (Canada + USA)

TERMINAL SYMBOLS

	Quick-connect terminal		Cable
	Solder terminal		Terminal strip
	Short solder terminal		Push-in terminal
	PCB terminal		Snap-in terminal
	PCB terminal angled to left		Cut terminal
	PCB terminal angled to right		Screw terminal
	Socket terminal		

ACTUATOR SYMBOLS

	Straight lever		Lever simulated roller with adjusting screw
	Lever simulated roller		Lever with adjusting screw and roller
	Lever with roller		Lever with cams
	Differential lever		Housing cams
	Spring lever		Pushbutton
	Spring lever bent		Rotary shaft
	Spring lever with molded spring cam		Standard actuator
	Lever with adjusting screw		Mushroom-shaped actuator

ABBREVIATIONS TECHNICAL DRAWINGS

ad	Adjustable	OP	Operating position
AN	Anode	OP NC	Operating position normally closed contact
BL	Block	OP NO	Operating position normally open contact
FH	Fixing hole, locating hole fixing pin	OR	On request
FI	Fields for function indicator	RC	Recommended cut-out
FP	Free position	RL	Reference level
FX	Fixing pin	SH	Snap-in hole
ju	Adjusted	SL	Symbol limit
MC	Marking cathode	SP	Solder pads
MF	Mounting frame	ST	Slide travel
MP	Measuring point	SW	Switching position
OFF	Off	TH	Terminal hole
off-range	Zero position	tk	Thick
OG	Operating range	to	Top
ON	On	TP	Total travel position

SWITCHING FREQUENCY (ABBREVIATIONS)

e.g. 5E4 switching cycles $\hat{=}$ 50 000 switching cycles