

IGBT MODULE (S series) 1200V / 35A / PIM

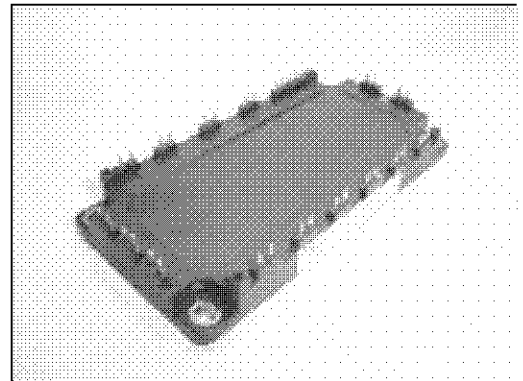

■ Features

- Low $V_{CE(sat)}$
- Compact package
- P.C. board mount
- Converter diode bridge, Dynamic brake circuit

■ Applications

- Inverter for motor drive
- AC and DC servo drive amplifier
- Uninterruptible power supply

■ Maximum ratings and characteristics

● Absolute maximum ratings ($T_c=25^\circ\text{C}$ unless without specified)

Item	Symbol	Condition	Rating	Unit	
Inverter	Collector-Emitter voltage	V_{CES}	1200	V	
	Gate-Emitter voltage	V_{GES}	± 20	V	
	Collector current	I_C	Continuous	$T_c=25^\circ\text{C}$ $T_c=80^\circ\text{C}$	50 35
			I_{CP}	1ms	$T_c=25^\circ\text{C}$ $T_c=80^\circ\text{C}$
		$\leq I_C$			35
	Collector power dissipation	P_C	1 device	240	W
Brake	Collector-Emitter voltage	V_{CES}	1200	V	
	Gate-Emitter voltage	V_{GES}	± 20	V	
	Collector current	I_C	Continuous	$T_c=25^\circ\text{C}$ $T_c=80^\circ\text{C}$	35 25
			I_{CP}	1ms	$T_c=25^\circ\text{C}$ $T_c=80^\circ\text{C}$
		Collector power dissipation	P_C	1 device	180
	Repetitive peak reverse voltage	V_{RRM}		1200	V
Converter	Repetitive peak reverse voltage	V_{RRM}	1600	V	
	Average output current	I_O	50Hz/60Hz sine wave	35	
	Surge current (Non-Repetitive)	I_{FSM}	$T_j=150^\circ\text{C}$, 10ms	360	
	I^2t (Non-Repetitive)	I^2t	half sine wave	648	
Operating junction temperature	T_j		+150	$^\circ\text{C}$	
Storage temperature	T_{stg}		-40 to +125	$^\circ\text{C}$	
Isolation voltage	between terminal and copper base *2	V_{iso}	AC : 1 minute	AC 2500	
	between thermistor and others *3			AC 2500	
Mounting screw torque			3.5 *1	N·m	

*1 Recommendable value : 2.5 to 3.5 N·m (M5)

*2 All terminals should be connected together when isolation test will be done.

*3 Terminal 8 and 9 should be connected together. Terminal 1 to 7 and 10 to 24 should be connected together and shorted to copper base.

● Electrical characteristics (Tj=25°C unless otherwise specified)

Item	Symbol	Condition	Characteristics			Unit			
			Min.	Typ.	Max.				
Inverter	Zero gate voltage collector current	ICES	VCE=1200V, VGE=0V			1.0	mA		
	Gate-Emitter leakage current	IGES	VCE=0V, VGE=±20V			0.2	µA		
	Gate-Emitter threshold voltage	VGE(th)	VCE=20V, IC=35mA			5.5	7.2	8.5	V
	Collector-Emitter saturation voltage	VCE(sat)	VGE=15V, IC=35A	chip	2.1		V		
				terminal	2.25			2.7	
	Input capacitance	Cies	VGE=0V, VCE=10V, f=1MHz			4200		µF	
	Turn-on time	ton	VCC=600V IC=35A	0.35		1.2	µs		
				0.25					
				0.1					
	Turn-off	toff	VGE=±15V RG=33Ω	0.45		1.0			
0.08				0.3					
Forward on voltage	VF	IF=35A	chip	2.3		V			
			terminal	2.45			3.3		
Reverse recovery time of FRD	trr	IF=35A			0.35		µs		
Brake	Zero gate voltage collector current	ICES	VCE=1200V, VGE=0V			1.0		mA	
	Gate-Emitter leakage current	IGES	VCE=0V, VGE=±20V			0.2		µA	
	Collector-Emitter saturation voltage	VCE(sat)	IC=25A, VGE=15V	chip	2.1		V		
				terminal	2.25			2.7	
	Turn-on time	ton	VCC=600V IC=25A	0.35		1.2	µs		
				0.25					
	Turn-off time	toff	VGE=±15V RG=51Ω	0.45		1.0			
				0.08				0.3	
	Reverse current	IRRM	VR=1200V			1.0		mA	
	Forward on voltage	VFM	IF=35A	chip	1.1		V		
terminal				1.2		1.5			
Resistance	R	T=25°C			5000		Ω		
B value	B	T=100°C			465	495		520	
		T=25/50°C			3305	3375		3450	

● Thermal resistance Characteristics

Item	Symbol	Condition	Characteristics			Unit
			Min.	Typ.	Max.	
Thermal resistance (1 device)	Rth(j-c)	Inverter IGBT			0.52	°C/W
		Inverter FWD			0.90	
		Brake IGBT			0.69	
		Converter Diode			0.75	
Contact thermal resistance	Rth(c-f)	With thermal compound	0.05			

* This is the value which is defined mounting on the additional cooling fin with thermal compound

■ Equivalent Circuit Schematic

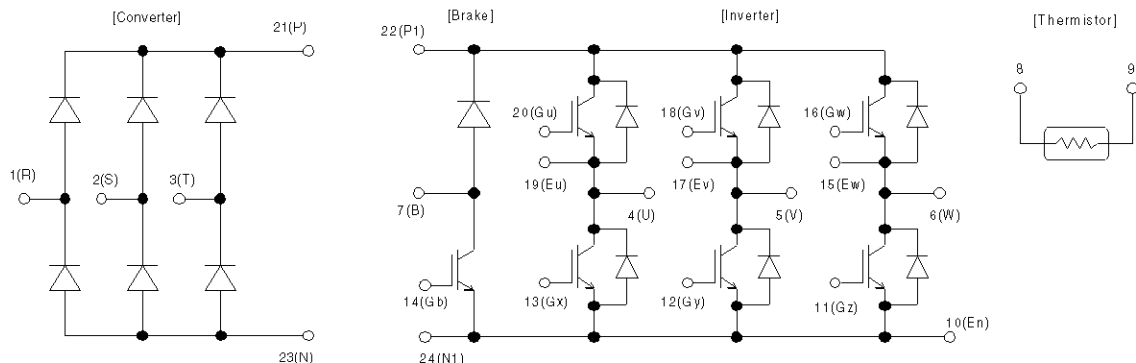

Characteristics (Representative)

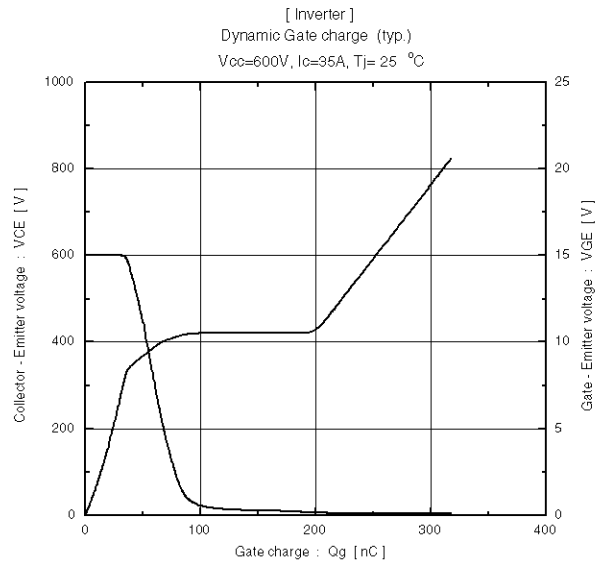
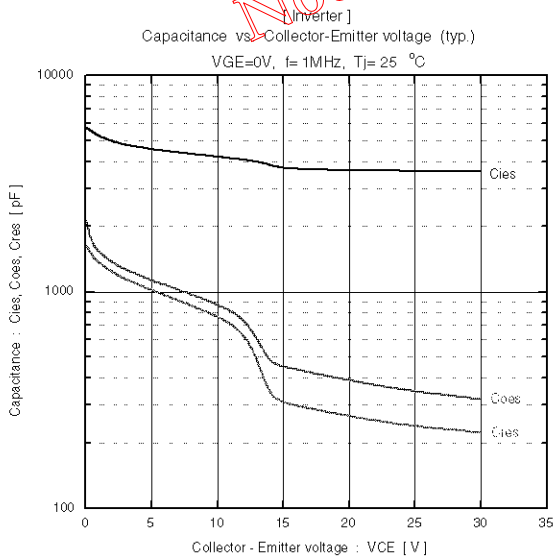
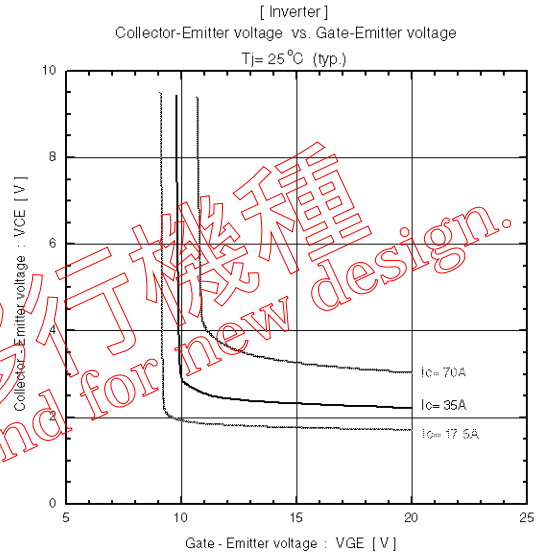
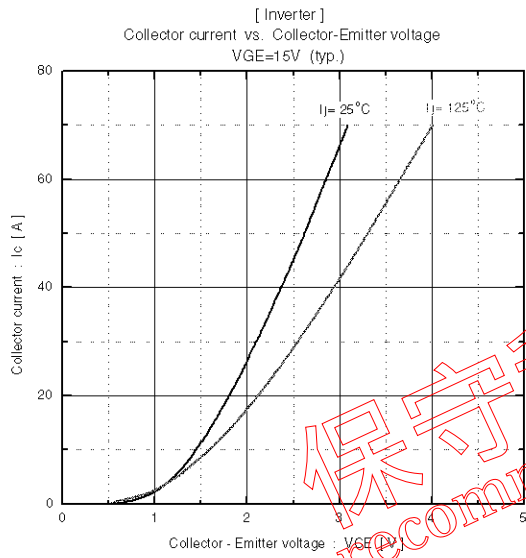
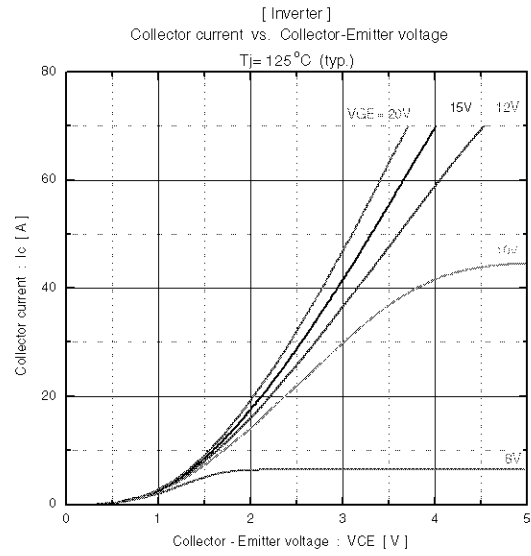
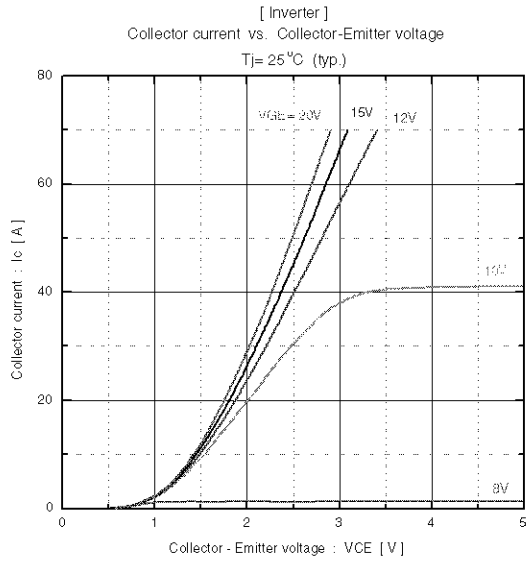

保守移行機種
Not recommend for new design.

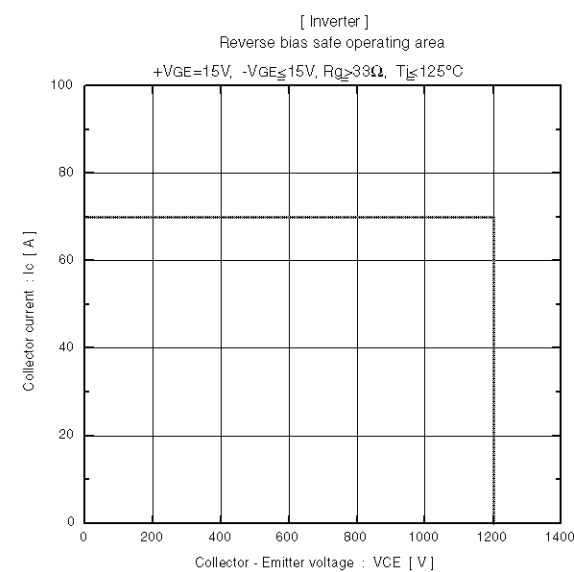
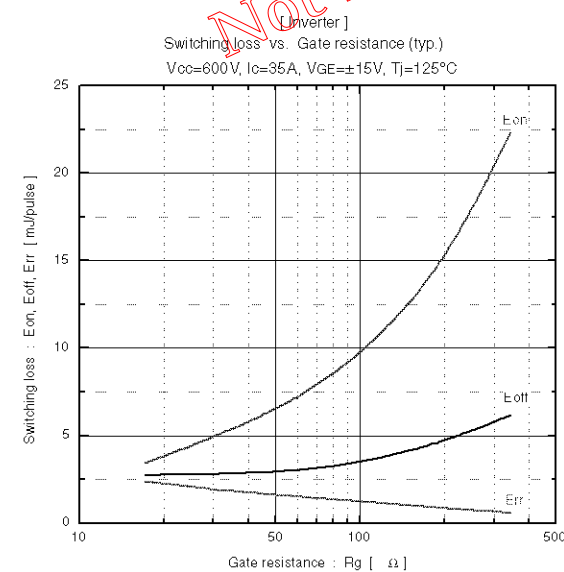
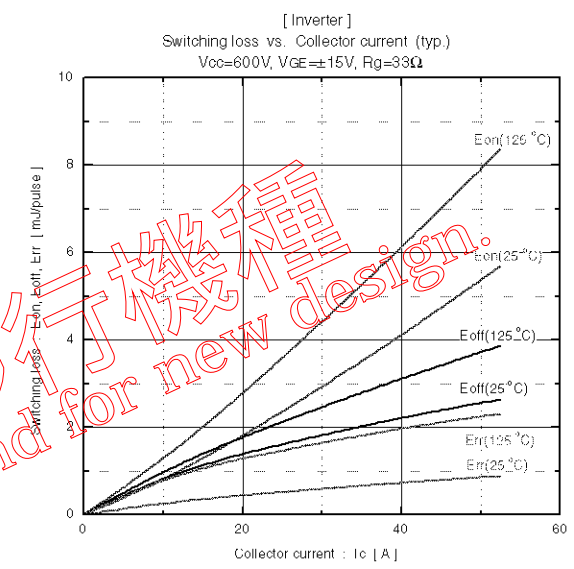
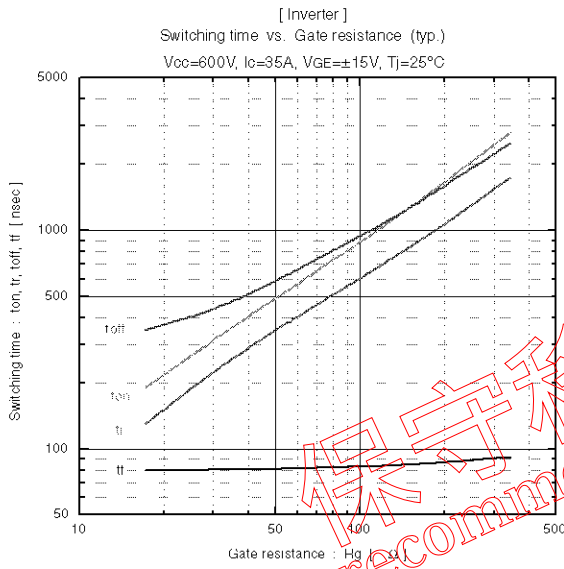
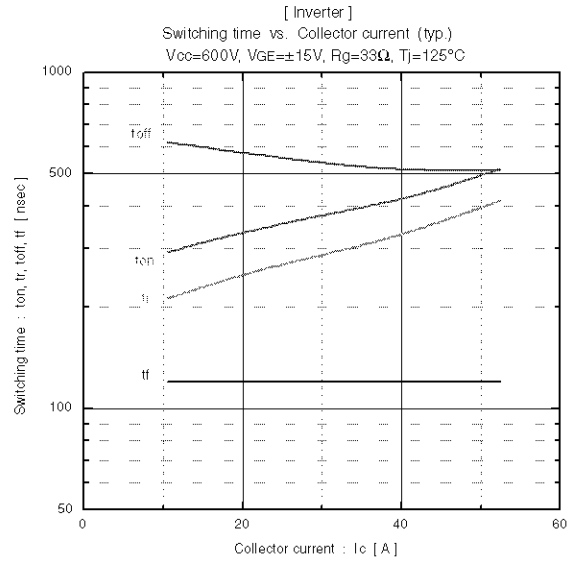
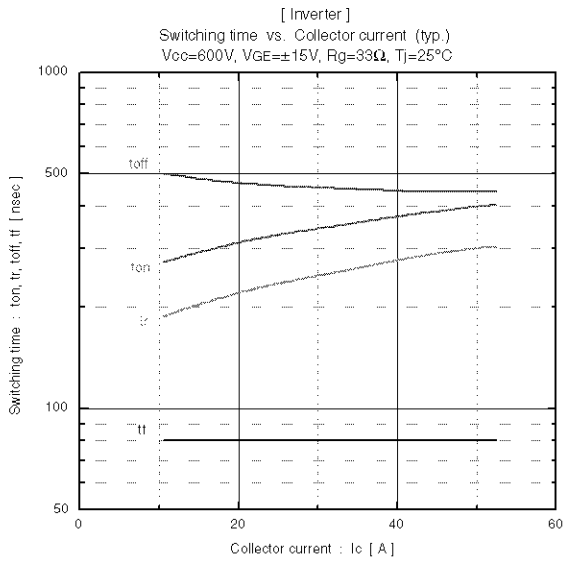

保守移行機種
Not recommend for new design.

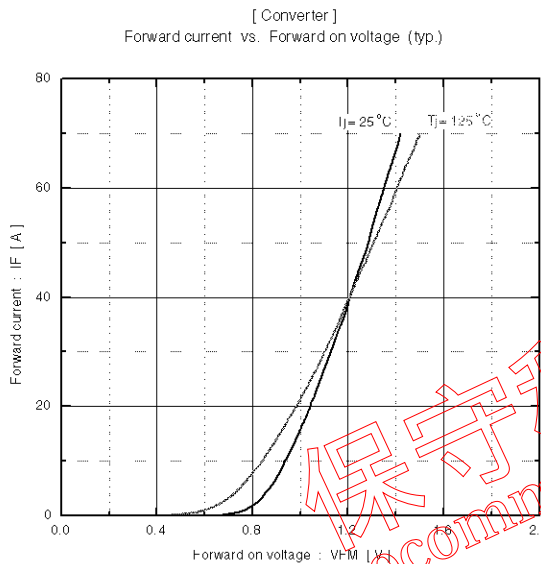
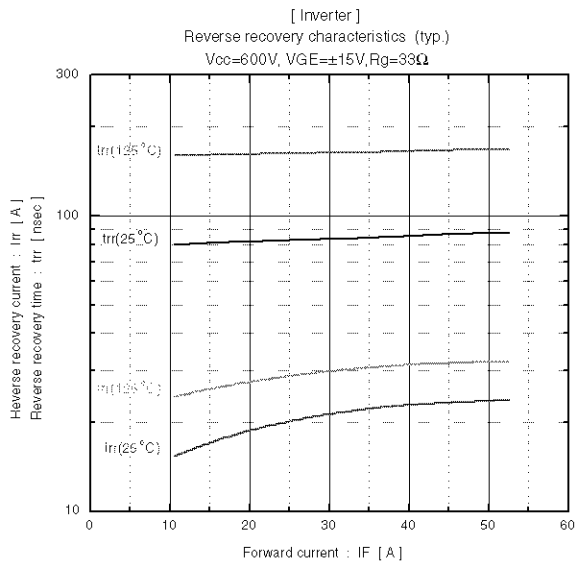
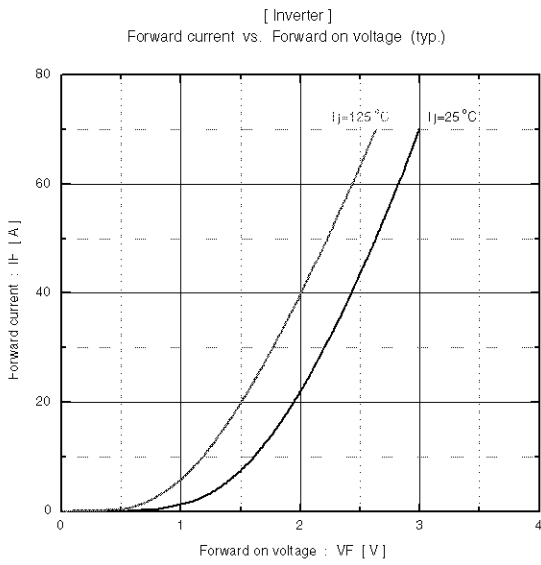

保守移行機種
Not recommend for new design.

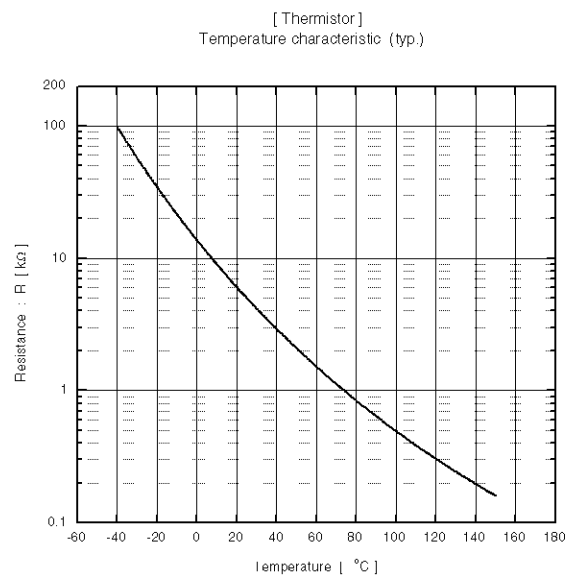
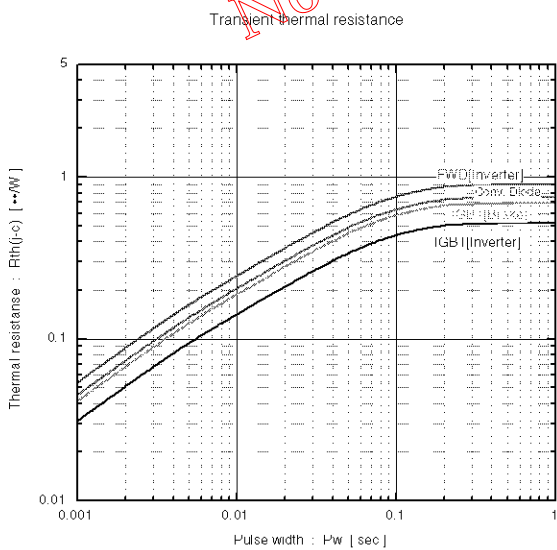

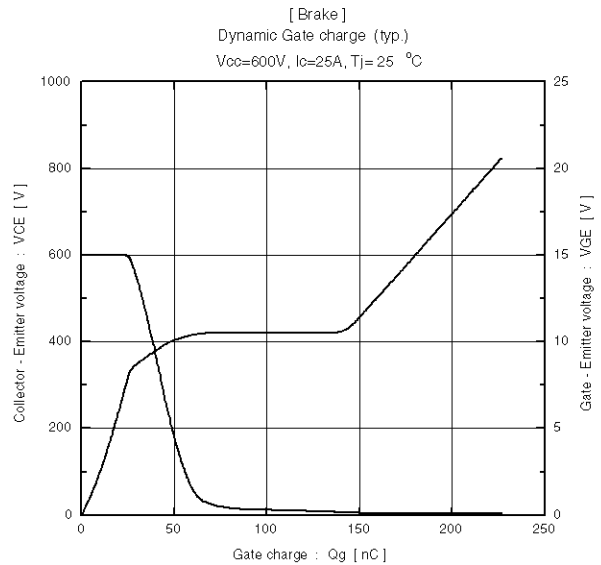
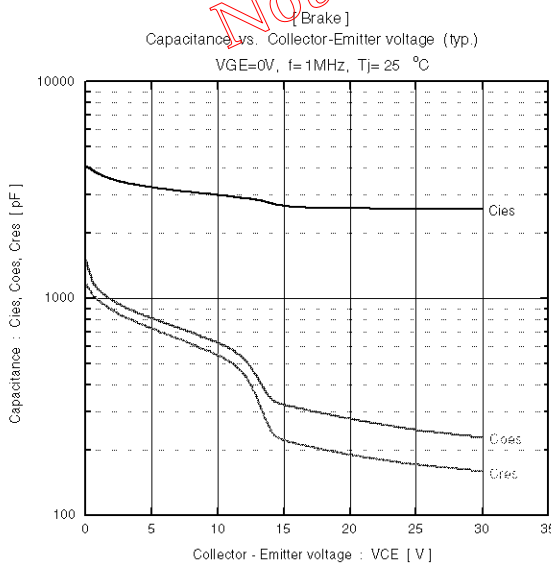
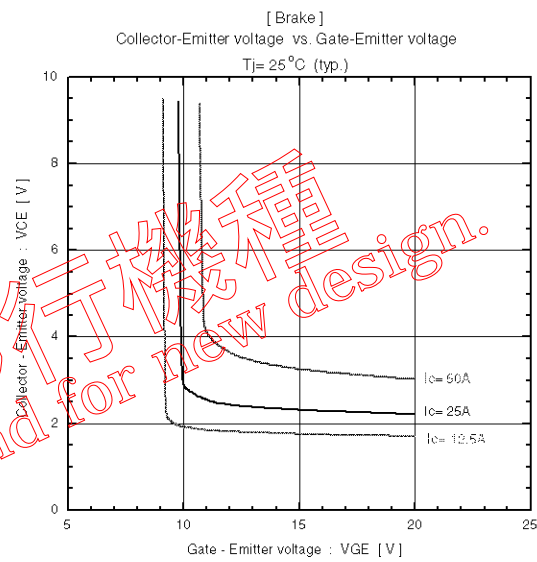
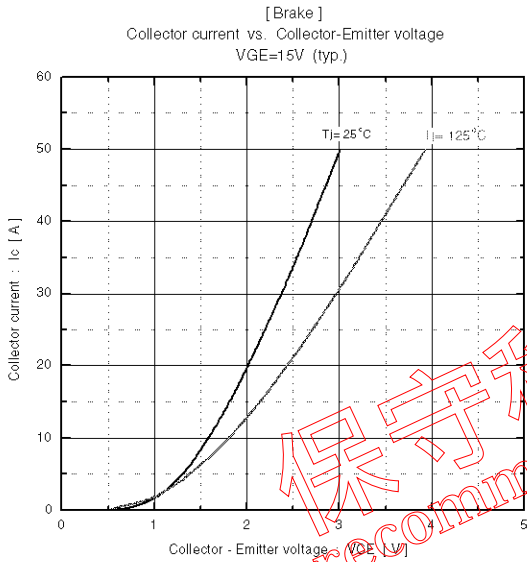
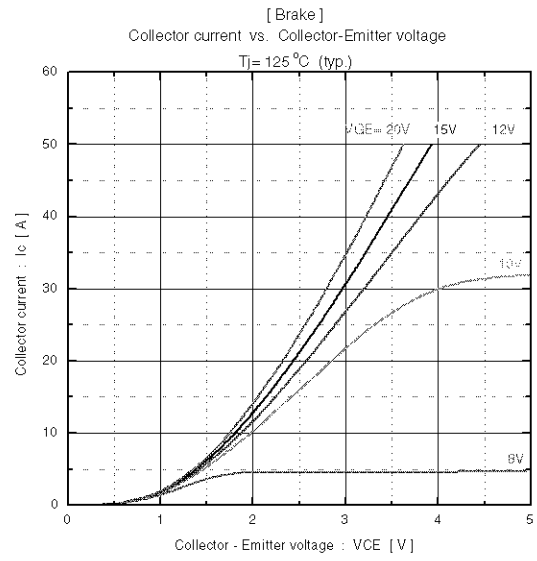
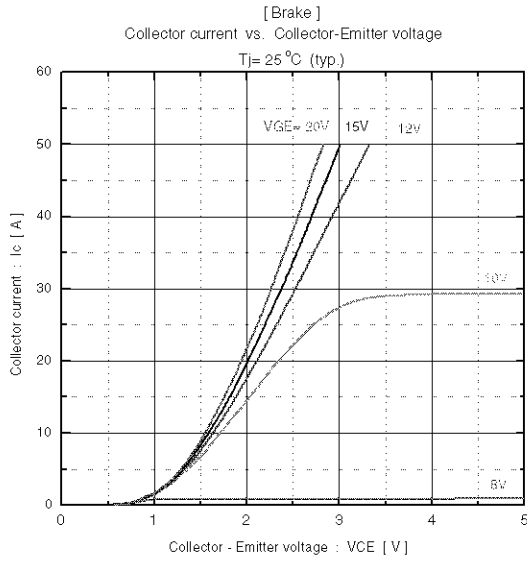

保守移行機種
Not recommend for new design.

■ Outline Drawings, mm

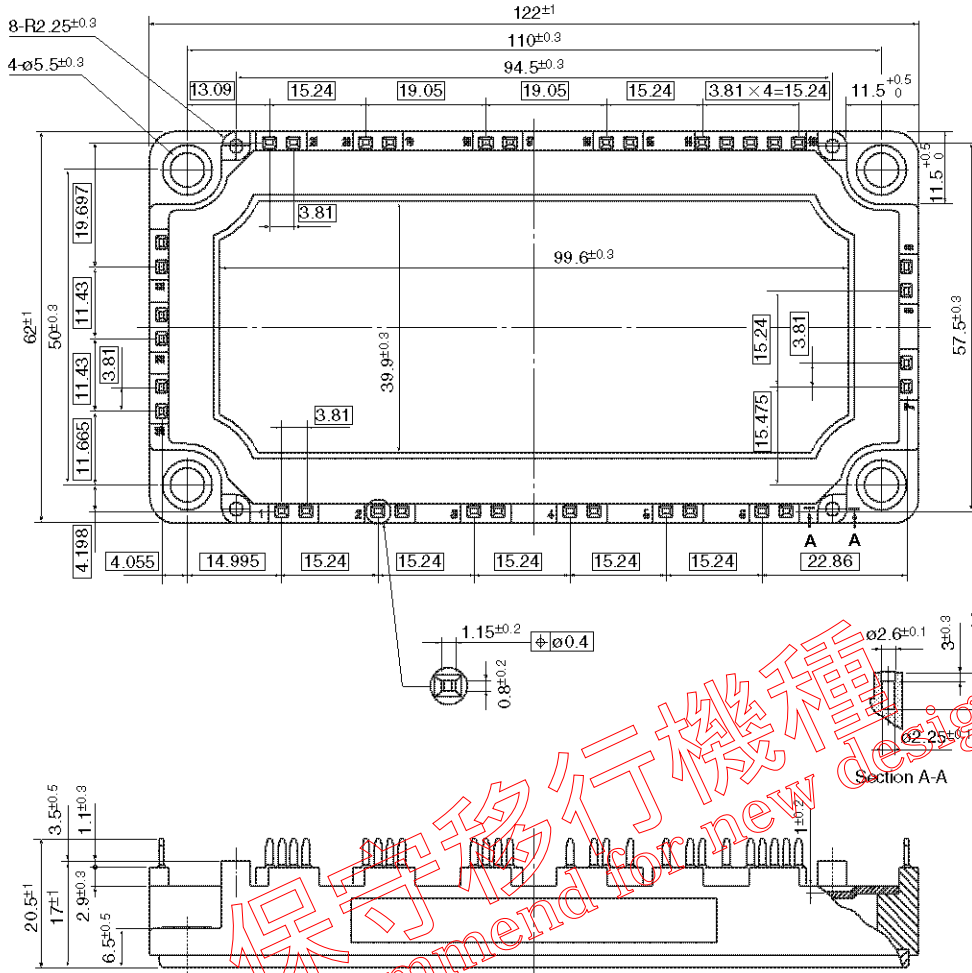

保守移行機種
Not recommend for new design.

□ Shows theory dimensions