

BASE PLATE 90X90 M10

Article Nr. 21.1041/0

[See the product on the website](#) →

[Download CAD Files](#) →

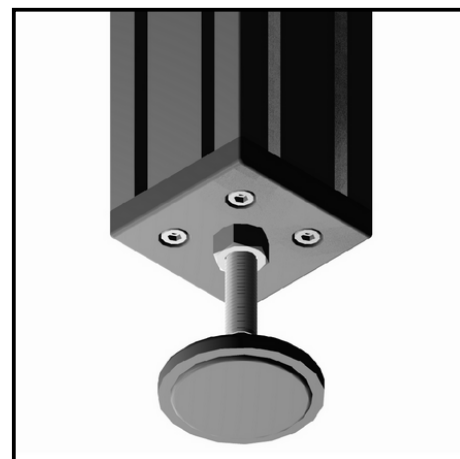
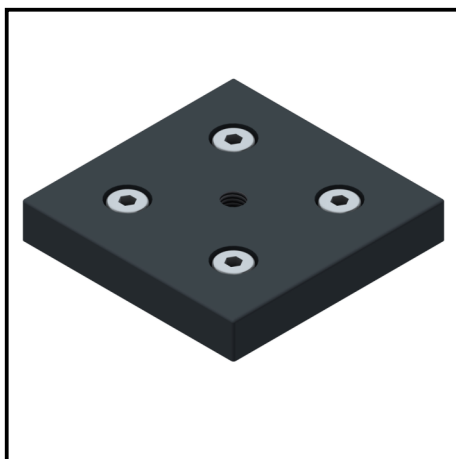
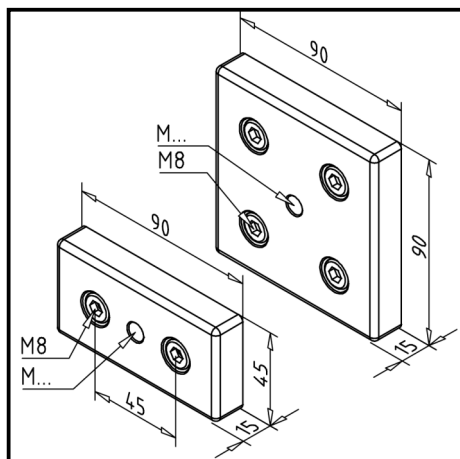

TECHN. DATA / ITEMS SUPPLIED

- Aluminium, Pressure die-casting, powder-coated, grey
- Fastening kit
- Weight = 0.334 kg/piece

APPLICATIONS

- Centric attachment of hinged feet to profiles 90 x 90

ASSEMBLY

- Use fixing material supplied to fix to the end face of the profile