

PROFITEST | MASTER Series

PROFITEST | MBASE MTECH

DIN VDE 0100/IEC 60364-6 Testers



3-349-471-03
22/2.14

Testing of residual current devices (RCCBs)

- Measurement of contact voltage without tripping the RCCB. Contact voltage is measured with reference to nominal residual current using 1/3 of the nominal residual current value.
- Testing for N-PE reversal
- Tripping test with nominal residual current, trip time measurement
- Testing of equipment and RCCBs with rising residual current including indication of tripping current and contact voltage
- Testing of RCCBs with $\frac{1}{2} \cdot I_{\Delta N}$, $1 \cdot I_{\Delta N}$, $2 \cdot I_{\Delta N}$, $(5 \cdot I_{\Delta N} \text{ to } 100 \text{ mA nominal current})$

Testing of Special RCDs

- Testing of selective **S** SRCDs, PRCDs (SCHUKOMAT, SIDOS or comparable), type G/R, type AC, type A, F; type B and B+ (except **PROFITEST MBASE**)
- Testing of RCCBs which are suitable for pulsating residual direct current; testing is conducted with positive or negative half-waves.
- Intelligent data transfer
Bidirectional interface to DDS-CAD electronic engineering
- **New!** Simulation of operating states of electric vehicles at electric charging stations in combination with the MENNEKES test box (**PROFITEST MTECH** only)



DESIGN PLUS

powered by: **light+building**



QUALITY MANAGEMENT SYSTEM



DQS Certified per DIN EN ISO 9001



German Accreditation Body
D-K-15080-01-01

DAkkS Calibration Certificate as Standard Feature

Large Voltage and Frequency Ranges

A broad-range measuring device allows for use of the test instrument in all alternating and 3-phase electrical systems with voltages from 65 to 500 V and frequencies of 16 to 400 Hz.

Loop and Line Impedance Measurement

Measurement of loop and line impedance can be performed in the 65 to 500 V range. Conversion to short-circuit current is based on the respective nominal line voltage, insofar as the measured line voltage is within the specified range. **PROFITEST MASTER** measuring error is also taken into account for conversion. Outside of this range, short-circuit current is calculated on the basis of momentary line voltage and measured impedance.

Measurement of Insulation Resistance Using Nominal Voltage, with Variable or Rising Test Voltage

Insulation resistance is usually measured with a nominal voltages of 500, 250 or 100 V. A test voltage which deviates from nominal voltage, and lies within a range of 50 to 1000 V, can be selected for measurements at sensitive components, as well as systems with voltage limiting devices.

Measurement can be performed with a constantly rising test voltage in order to detect weak points in the insulation and determine tripping voltage for voltage limiting devices.

Voltage at the device under test and any triggering/breakdown voltage appear at the test instrument's display.

Standing-Surface Insulation Measurement

Standing-surface insulation measurement is performed with momentary line frequency and line voltage.

Low-Resistance Measurement

Bonding conductor resistance and protective conductor resistance can be measured with a test current of ≥ 200 mA DC, automatic polarity reversal of the test voltage and selectable direction of current flow. If the adjustable limit value is exceeded, an LED lights up.

Earthing Resistance Measurement

In addition to earth resistance measurement, a selective earth resistance measurement is possible with the **PROFITEST MTECH** in combination with accessory current clamps.

Universal Connector System

The interchangeable plug inserts and 2-pole plug-in adapter – which can be expanded to 3-poles for phase sequence testing – allows for use of the test instrument all over the world.

Special Features

- Display of approved fuse types for electrical systems
- Energy meter start-up testing
- Measurement of biasing, leakage and circulating current of up to 1 A, as well as working current of up to 1000 A with current clamp sensor (available as an accessory)
- Phase sequence measurement (including highest line-to-line voltage)
- **new!** **PROFITEST MBASE**: automatic test sequence function specified in the device for measuring of RCDs Type A
- **new!** **PROFITEST MTECH**: automatic test sequence function specified in the device for measuring of RCDs Type A and B as well as loop impedances with DC-Offset and positive half wave

PROFITEST | MBASE MTECH

DIN VDE 0100/IEC 60364-6 Testers

Display with Selectable Language

The LCD panel consists of a backlit dot matrix at which menus, setting options, measurement results, tables, instructions and error messages, as well schematic diagrams appear.

The display can be set to the desired language depending on the country in which the test instrument is used:

D, GB, I, F, E, P, NL, S, N, FIN, CZ or PL

Operation

Device functions are selected directly with the help of a rotary selector knob. Softkeys allow for convenient selection of sub-functions and parameter settings. Unavailable functions and parameters are automatically prevented from appearing at the display.

The start and RCD tripping functions included directly on the instrument are identical to the functions of the two keys located on the test plug, allowing for easy measurement at difficult to access locations.

Schematic diagrams, measuring ranges and help texts can be displayed for all basic functions and sub-functions.

Phase Tester

Protective conductor potential is tested after starting a test sequence and touching the contact surface for finger contact. The PE symbol appears at the display if a potential difference of more than 25 V is detected between the contact surface and the protective contact at the mains plug.

Error Indication

- The instrument automatically detects **instrument-to-system connection errors**, which are indicated in a connection pictograph.
- **Errors within the electrical system** (no mains or phase voltage, tripped RCD) are indicated at 3 LEDs and by means of pop-up windows at the tilting LCD panel.

Battery Monitoring and Self-Test

Battery monitoring is conducted while the instrument is subjected to an electrical load. Results are displayed both numerically and with a symbol. Test images can be called up one after the other, and LEDs can be tested during the self-test. The instrument is shut down automatically when the rechargeable batteries are discharged. A microprocessor controlled charging circuit is used to assure safe charging of rechargeable NiMH or NiCd batteries.

Data Entry at the RS 232 Port

Data can be read in via a barcode or RFID scanner connected to the RS 232 port, and comments can be entered with the help of the softkeys.

ETC User Software for PC

ETC offers a wide variety of support options for data acquisition and management.

- Amongst other things, the software acquires all important data for reports in accordance with DIN VDE 0100, part 600.
- Test reports (ZVEH) can be generated automatically.
- Distribution structures with electrical circuit and RCD data can be individually defined.
- Created structures can be saved to memory and loaded to the test instrument as required via the USB port.
- Data can be exported to Excel, CSV and XML formats.
- Device selection lists can be edited.

Overview of Features Included with PROFITEST MASTER Device Variants

PROFITEST ...	MBASE	MPRO	MTECH	MxTRA
Article number	M520M	M520N	M520O	M520P
Testing of residual current devices (RCDs)				
U _B measurement without RCD tripping	✓	✓	✓	✓
Tripping time measurement	✓	✓	✓	✓
Measurement of tripping current I _T	✓	✓	✓	✓
Selective, SRCDs, PRCDs, type G/R	✓	✓	✓	✓
AC/DC sensitive RCDs, type B, type B+	—	—	✓	✓
Testing IMDs	—	—	—	✓
Testing of RCMs	—	—	—	✓
Testing for N-PE reversal	✓	✓	✓	✓
Measurement of loop impedance Z_{L-PE} / Z_{L-N}				
Fuse table for systems without RCDs	✓	✓	✓	✓
Without tripping the RCD, fuse table	—	—	✓	✓
15 mA test current ¹ , no RCD tripping	✓	✓	✓	✓
Earthing resistance R_E (mains operation)				
I-U measuring method (2/3-wire measuring method via measuring adapter: 2-wire/2-wire + probe)	✓	✓	✓	✓
Earthing resistance R_E (battery operation)				
3 or 4-wire measuring method via PRO-RE adapter	—	✓	—	✓
Soil resistivity ρ_E (battery operation)				
(4-wire measuring method via PRO-RE adapter)	—	✓	—	✓
Selective earthing resistance R_E (mains operation)				
with 2-pole adapter, probe, earth electrode and current clamp sensor (3-wire)	✓	✓	✓	✓
Selective earthing resistance R_E (battery operation)				
with probe, earth electrode and current clamp sensor (4-wire measuring method via PRO-RE adapter and current clamp sensor)	—	✓	—	✓
Earth loop resistance R_{ELOOP} (battery operation)				
with 2 clamps (current clamp sensor direct and current clamp transformer via PRO-RE/2)	—	✓	—	✓
Measurement of equipotential bonding R_{LD}				
automatic polarity reversal	✓	✓	✓	✓
Insulation resistance R_{ISO}				
variable or rising test voltage (ramp)	✓	✓	✓	✓
Voltage U_{L-N} / U_{L-PE} / U_{N-PE} / f				
✓	✓	✓	✓	✓
Special measurements				
Leakage current (clamp) I_L, I_{AMP}				
✓	✓	✓	✓	✓
Phase sequence				
✓	✓	✓	✓	✓
Earth leakage resistance R_{E(ISO)}				
✓	✓	✓	✓	✓
Voltage drop				
✓	✓	✓	✓	✓
Standing-surface insulation Z_{ST}				
✓	✓	✓	✓	✓
Meter start-up				
✓	✓	✓	✓	✓
Leakage current with PRO-AB adapter				
—	—	—	—	✓
Residual voltage test				
—	—	—	—	✓
Intelligent ramp				
—	—	—	—	✓
Electric vehicles at charging stations (IEC 61851)				
—	—	—	✓	✓
Features				
Selectable user interface language³				
✓	✓	✓	✓	✓
Database for up to 50,000 objects				
✓	✓	✓	✓	✓
Automatic test sequence function				
✓ ²	✓	✓ ²	✓	✓
RS 232 port for RFID/barcode scanner				
✓	✓	✓	✓	✓
USB port for data transmission				
✓	✓	✓	✓	✓
Bluetooth® interface				
—	—	—	—	✓
ETC User Software for PC				
✓	✓	✓	✓	✓
CAT III 500 V / CAT IV 300 V				
✓	✓	✓	✓	✓
DAkKS calibration certificate				
✓	✓	✓	✓	✓

¹ So-called live measurement is only advisable if there is no bias current within the system. Only suitable for motor circuit breaker with low nominal current.

² Specified in the device, cannot be modified

³ Currently available languages: D, GB, I, F, E, P, NL, S, N, FIN, CZ, PL

PROFITEST | MBASE MTECH

DIN VDE 0100/IEC 60364-6 Testers

Data Interface

Measurement data are transmitted to a PC via the integrated USB port, at which they can be printed in report form and archived.

Software update

The test instrument is always kept current thanks to firmware which can be updated via the USB port. Software is updated during the course of recalibration by our service department, or directly by the customer.

Sample Displays

PROFITEST MASTER Test Instruments

Softkeys allow for convenient selection of sub-functions and parameter settings. Unavailable sub-functions and parameters are automatically prevented from appearing at the display.

RCD Measurement

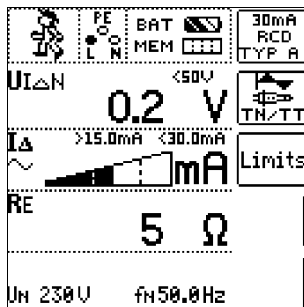

Loop Resistance Measurement

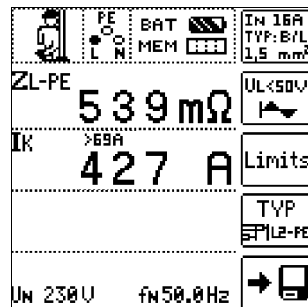

Earthing Resistance Measurement

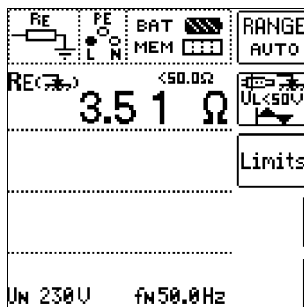

Low-Resistance Measurement

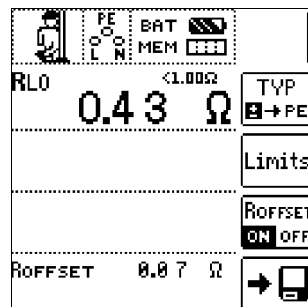

Insulation Measurement

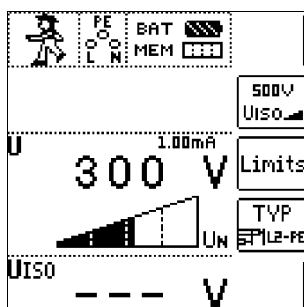

Voltage Measurement

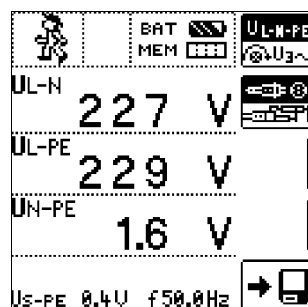

Applicable Regulations and Standards

IEC 61010-1 / EN 61010-1/ VDE 0411-1	Safety requirements for electrical equipment for measurement, control and laboratory use Part 1: General requirements (IEC 61010-1:2010 + Cor.:2011) Part 31: Safety requirements for hand-held probe assemblies for electrical measurement and test (IEC 61010-031:2002 + A1:2008)
IEC 61557/ EN 61557/ VDE 0413	Part 1: General requirements (IEC 61557-1:2007) Part 2: Insulation resistance (IEC 61557-2:2007) Part 3: Loop impedance (IEC 61557-3:2007) Part 4: Resistance of earth connection and equipotential bonding (IEC 61557-4:2007) Part 5: Resistance to earth (IEC 61557-5:2007) Part 6: Effectiveness of residual current devices (RCD) in TT, TN and IT systems (IEC 61557-6:2007) Part 7: Phase sequence (IEC 61557-7:2007) Part 10: Electrical safety in low voltage distribution systems up to 1000 V AC and 1500 V DC – Equipment for testing, measuring or monitoring of protective measures (IEC 61557-10:2000)
EN 60529 VDE 0470, part 1	Test instruments and test procedures Degrees of protection provided by enclosures (IP code)
DIN EN 61326-1 VDE 0843-20-1	Electrical equipment for measurement, control and laboratory use – EMC requirements – Part 1: General requirements
IEC 60364-6-61 VDE 0100, part 600	Low-voltage electrical installations – Part 6: Tests
IEC 60364-6-62 EN 50110-1 VDE 0105, part 100	Operation of electrical installations – Part 100: General requirements
IEC 60364-7-710 VDE 0100, part 710	Erection of low-voltage installations – Requirements for special installations or locations – Part 710: Medical locations
IEC 61851-1 DIN EN 61851-1	Electric vehicle conductive charging system – Part 1: General requirements

Characteristic Values

Nominal Ranges of Use

Voltage U_N	120 V	(108 ... 132 V)
	230 V	(196 ... 253 V)
	400 V	(340 ... 440 V)
Frequency f_N	16 $\frac{2}{3}$ Hz	(15.4 ... 18 Hz)
	50 Hz	(49.5 ... 50.5 Hz)
	60 Hz	(59.4 ... 60.6 Hz)
	200 Hz	(190 ... 210 Hz)
	400 Hz	(380 ... 420 Hz)

Overall voltage range	65 ... 550 V
Overall frequency range	15.4 ... 420 Hz
Waveform	sine
Temperature range	0 °C ... + 40 °C
Battery voltage	8 ... 12 V
Line impedance angle	Corresponds to $\cos\phi = 1 \dots 0.95$
Probe resistance	< 50 kΩ

PROFITEST | MBASE MTECH

DIN VDE 0100/IEC 60364-6 Testers

Function	Measured Quantity	Display Range	Resolution	Input Impedance/ Test Current	Measuring Range	Nominal Values	Measuring Uncertainty	Intrinsic Uncertainty	Connections						
									Plug Insert ¹⁾	2-Pole Adapter	3-Pole Adapter	Probe	Clamps WZ12C	Z3512A	MFLEX P300
U	U _{L-PE} U _{N-PE}	0 ... 99.9 V 100 ... 600 V	0.1 V 1 V	5 MΩ	90 ... 600 V ¹⁾	U _N = 120/230/ 400/500 V f _N = 16 ^{2/3} /50/ 60/200/400 Hz	±(2% rdg.+5d) ±(2% rdg.+1d)	±(1% rdg.+5d) ±(1% rdg.+1d)	●	●	●				
	f	15.0 ... 99.9 Hz 100 ... 999 Hz	0.1 Hz 1 Hz		15.4 ... 420 Hz		±(0.2% rdg.+1d)	±(0.1% rdg.+1d)							
	U ₃₋	0 ... 99.9 V 100 ... 600 V	0.1 V 1 V		90 ... 600 V		±(3% rdg.+5d) ±(3% rdg.+1d)	±(2% rdg.+5d) ±(2% rdg.+1d)				●			
	U _{PROBE}	0 ... 99.9 V 100 ... 600 V	0.1 V 1 V		0 ... 600 V		±(2% rdg.+5d) ±(2% rdg.+1d)	±(1% rdg.+5d) ±(1% rdg.+1d)					●		
	U _{L-N}	0 ... 99.9 V 100 ... 600 V	0.1 V 1 V		90 ... 600 V ¹⁾		±(3% rdg.+5d) ±(3% rdg.+1d)	±(2% rdg.+5d) ±(2% rdg.+1d)	●		●				
I _{ΔN} I _F	U _{IΔN}	0 ... 70.0 V	0.1 V	0.3 · I _{ΔN}	5 ... 70 V	U _N = 120/230 V f _N = 50/60 Hz U _L = 25/50 V I _{ΔN} = 10/30/ 100/300/500 mA U _N ^{1) 2)} = 400 V I _{ΔN} = 10/30 mA	+10% rdg.+1d	+1% rdg.-1d ... +9% rdg.+1d							
	R _E / I _{ΔN} = 10 mA	10 Ω ... 6.51 kΩ	10 Ω		calculated value from U _{IΔN} / I _{ΔN}										
	R _E / I _{ΔN} = 30 mA	3 Ω ... 999 Ω	3 Ω												
	R _E / I _{ΔN} = 100 mA	1 Ω ... 651 Ω	1 Ω												
	R _E / I _{ΔN} = 300 mA	0.3 Ω ... 99.9 Ω	0.3 Ω												
	R _E / I _{ΔN} = 500 mA	0.2 Ω ... 9.99 Ω	0.2 Ω												
	I _A / I _{ΔN} = 10 mA	3.0 ... 13.0 mA	0.1 mA	3.0 ... 13.0 mA	3.0 ... 13.0 mA										
	I _A / I _{ΔN} = 30 mA	9.0 ... 39.0 mA		9.0 ... 39.0 mA	9.0 ... 39.0 mA										
	I _A / I _{ΔN} = 100 mA	30 ... 130 mA	1 mA	30 ... 130 mA	30 ... 130 mA										
	I _A / I _{ΔN} = 300 mA	90 ... 390 mA	1 mA	90 ... 390 mA	90 ... 390 mA										
	I _A / I _{ΔN} = 500 mA	150 ... 650 mA	1 mA	150 ... 650 mA	150 ... 650 mA										
	U _{IΔ} / U _L = 25 V	0 ... 25.0 V	0.1 V	wie I _A	0 ... 25.0 V				+10% rdg.+1d	+1% rdg.-1d ... +9% rdg.+1d					
	U _{IΔ} / U _L = 50 V	0 ... 50.0 V			0 ... 50.0 V										
t _A / I _{ΔN}	0 ... 1000 ms	1 ms	1.05 · I _{ΔN}	0 ... 1000 ms			±4 ms	±3 ms							
t _A / 5 · I _{ΔN}	0 ... 40 ms	1 ms	5 · I _{ΔN}	0 ... 40 ms											
Z _{L-PE} Z _{L-N}	Z _{L-PE} (full waves) Z _{L-N}	0 ... 999 mΩ 1.00 ... 9.99 Ω	1 mΩ 0.01 Ω 0.1 Ω	0.65...3.4 A AC 0.5/1.25 A DC	0.15 ... 0.49 Ω 0.50 ... 0.99 Ω 1.00 ... 9.99 Ω	U _N = 120/230 V	±(10% rdg.+30d) ±(10% rdg.+30d) ±(5% rdg.+3d)	±(5% rdg.+30d) ±(4% rdg.+30d) ±(3% rdg.+3d)							
	Z _{L-PE} DC+	0 ... 999 mΩ 1.00 ... 9.99 Ω 10.0 ... 29.9 Ω			0.25 ... 0.99 Ω 1.00 ... 9.99 Ω	U _N = 400 V ¹⁾ / 500 V at Z _{L-PE}	±(18% rdg.+30d) ±(10% rdg.+3d)	±(6% rdg.+50d) ±(4% rdg.+3d)	●	●	Z _{L-PE}				
	I _k	0 A ... 999 A 1.00 kA ... 9.99 kA 10.0 kA ... 50.0 kA	1 A 10 A 100 A		120 (108 ... 132) V 230 (196 ... 253) V 400 (340 ... 440) V	f _N = 16 ^{2/3} /50/60 Hz	calculated value from Z _{L-PE}								
	Z _{L-PE} (15 mA)	0.5 ... 9.99 Ω 10.0 ... 99.9 Ω 100 ... 999 Ω	0.01 Ω 0.1 Ω 1 Ω		15 mA	10 ... 100 Ω 100 ... 1000 Ω	U _N = 120/230 V f _N = 16 ^{2/3} /50/60 Hz	only display range ±(10% v.M.+10D) ±(8% v.M.+2D)	±(2% v.M.+2D) ±(1% v.M.+1D)						
	I _k (15 mA)	100 ... 999 mA 0.00 ... 9.99 A 10.0 ... 99.9 A	1 mA 0.01 A 0.1 A			calcul. value depends on U _N and Z _{L-PE} : I _k = U _N / 10 ... 1000 Ω		calculated value from Z _{L-PE} (15 mA): I _k = U _N / Z _{L-PE} (15 mA)							
R _E	R _E (with probe)	0 ... 999 mΩ 1.00 ... 9.99 Ω 10.0 ... 99.9 Ω 100 ... 999 Ω 1 kΩ ... 9.99 kΩ	1 mΩ 0.01 Ω 0.1 Ω 1 Ω 0.01 kΩ	0.65 ... 3.4 A 0.65 ... 3.4 A 0.65 ... 3.4 A 400 mA 40 mA 4 mA	0.15 Ω ... 0.49 Ω 0.50 Ω ... 0.99 Ω 1.0 Ω ... 9.99 Ω 10 Ω ... 99.9 Ω 100 Ω ... 999 Ω 1 kΩ ... 9.99 kΩ	U _N = 120/230 V U _N = 400 V ¹⁾ f _N = 50/60 Hz	±(10% rdg.+30d) ±(10% rdg.+30d) ±(5% rdg.+3d) ±(10% rdg.+3d) ±(10% rdg.+3d) ±(10% rdg.+3d)	±(5% rdg.+30d) ±(4% rdg.+30d) ±(3% rdg.+3d) ±(3% rdg.+3d) ±(3% rdg.+3d) ±(3% rdg.+3d)	●	●					
	R _E DC+	0 ... 999 mΩ 1.00 ... 9.99 Ω 10.0 ... 29.9 Ω	1 mΩ 0.01 Ω 0.1 Ω	0.65...3.4 A AC 0.5/1.25 A DC	0.25 ... 0.99 Ω 1.00 ... 9.99 Ω	U _N = 120/230 V f _N = 50/60 Hz	±(18% rdg.+30d) ±(10% rdg.+3d)	±(6% rdg.+50D) ±(4% v.M.+3D)							
	U _E	0 ... 253 V	1 V	—	calculated value										
	R _E Sel clip	R _E R _E DC+	0 ... 999 Ω	1 mΩ ... 1 Ω	0.65...3.4 A AC 0.5/1.25 A DC	0.25 ... 300 Ω ⁵⁾	see R _E U _N = 120/230 V f _N = 50/60 Hz	±(20% rdg.+20 D) ±(22% v.M.+20 D)	±(15% rdg.+20 d) ±(15% rdg.+20 d)						
EX- TRA	Z _{ST}	0 ... 30 MΩ	1 kΩ	2.3 mA at 230 V	10 kΩ ... 199 kΩ 200 kΩ ... 30 MΩ	U ₀ = U _{L-N}	±(20% rdg.+2d) ±(10% rdg.+2d)	±(10% rdg.+3d) ±(5% rdg.+3d)							
R _{INS}	R _{INS} · R _{EINS}	1 ... 999 kΩ 1.00 ... 9.99 MΩ 10.0 ... 49.9 MΩ	1 kΩ 10 kΩ 100 kΩ	I _k = 1.5 mA	50 kΩ ... 500 MΩ	U _N = 50 V I _N = 1 mA	kΩ range ±(5% rdg.+10d)	kΩ range ±(3% rdg.+10d)	●	●					
		1 ... 999 kΩ 1.00 ... 9.99 MΩ 10.0 ... 99.9 MΩ	1 kΩ 10 kΩ 100 kΩ			U _N = 100 V I _N = 1 mA									
		1 ... 999 kΩ 1.00 ... 9.99 MΩ 10.0 ... 99.9 MΩ 100 ... 200 MΩ	1 kΩ 10 kΩ 100 kΩ 1 MΩ			U _N = 250 V I _N = 1 mA									
		1 ... 999 kΩ 1.00 ... 9.99 MΩ 10.0 ... 99.9 MΩ 100 ... 500 MΩ	1 kΩ 10 kΩ 100 kΩ 1 MΩ			U _N = 500 V/ 1000 V I _N = 1 mA									
	U	25 ... 1200 V	1 V		25 ... 1200 V		±(3% rdg.+1d)	±(1.5% rdg.+1d)							
R _{LO}	R _{LO}	0.01 Ω ... 9.99 Ω 10.0 Ω ... 99.9 Ω	10 mΩ 100 mΩ	I _m ≥ 200 mA	0.1 Ω ... 6 Ω	U ₀ = 4.5 V	±(4% rdg.+2d)	±(2% rdg.+2d)		●					

PROFITEST | MBASE MTECH

DIN VDE 0100/IEC 60364-6 Testers

Function	Measured Quantity	Display Range	Resolution	Input Impedance/ Test Current	Measuring Range	Nominal Values	Measuring Uncertainty	Intrinsic Uncertainty	Connections							
									Plug Insert 1)	2-Pole Adapter	3-Pole Adapter	Probe	Clamps WZ12C	Z3512A	MFLEX P300	
SENSOR	I _L /Amp	0 ... 99.9 mA	0.1 mA		5 ... 1000 mA ³⁾		±(10% rdg.+8d)	±(4% rdg.+7d)								
		100 ... 999 mA	1 mA				±(10% rdg.+3d)	±(4% rdg.+2d)								
		0 ... 99.9 A	0.1 A				±(8% rdg.+2d)	±(3% rdg.+2d)								
		100 ... 150 A	1 A				±(8% rdg.+1d)	±(3% rdg.+1d)								
		0 ... 99.9 mA	0.1 mA	1 V/A	5 ... 1000 mA ⁴⁾	0.05 ... 10 A ⁴⁾ 0.5 ... 100 A ⁴⁾ 5 ... 1000 A ⁴⁾	U _N = 120/230/ 400 V f _N = 50/60 Hz	±(7% rdg.+8d)	±(4% rdg.+7d)							
		100 ... 999 mA	1 mA					±(5% rdg.+3d)	±(2% rdg.+2d)							
		1.0 ... 9.99 A	0.01 A					±(4% rdg.+2d)	±(2% rdg.+2d)							
		10.0 ... 99.9 A	0.1 A					±(4% rdg.+2d)	±(2% rdg.+2d)							
		100 ... 999 A	1 A					±(4% rdg.+1d)	±(2% rdg.+1d)							
		1.00 ... 1.02 kA	0.01 kA					±(4% rdg.+1d)	±(2% rdg.+1d)							
		0 ... 99.9 mA	0.1 mA					±(7% rdg.+100d)	±(4% rdg.+100d)							
		100 ... 999 mA	1 mA					±(6% rdg.+12d)	±(3% rdg.+12d)							
		1.0 ... 9.99 A	0.01 A	±(6% rdg.+12d)	±(3% rdg.+12d)											
		10.0 ... 99.9 A	0.1 A	±(5% rdg.+11d)	±(2% rdg.+11d)											

1) U > 253 V, with 2 or 3-pole adapter only

2) I_{AN} = 500 mA, max. U_N = 250 V

3) The measuring range respectively the transformation factor selected at the clamp (I_L=In: 1 mA...15 A/Out: 1 mV/mA or lamp = 1...150 A/1 mV/A) must be set in the "TYPE" menu with the selector switch in the SENSOR position.

4) The measuring range respectively the transformation factor selected at the clamp (x 1, x 10, x 100, x 1000 mV/A) must be set in the "TYPE" menu with the selector switch in the SENSOR position.

5) at R_{Eselektiv}/R_{Egesamt} < 100

Key: D = digits, rdg. = measured value (reading)

Reference Conditions

Line voltage	230 V ± 0.1 %
Line frequency	50 Hz ± 0.1 %
Meas. quantity frequency	45 Hz ... 65 Hz
Measured qty. waveform	Sine (deviation between effective and rectified value ≤ 0.1 %)
Line impedance angle	cos φ = 1
Probe resistance	≤ 10 Ω
Supply power	12 V ± 0.5 V
Ambient temperature	+ 23° C ± 2 K
Relative humidity	40% to 60%
Finger contact	For testing potential difference to ground potential
Standing surface insulation	Purely ohmic

Power Supply

Rechargeable batteries	8 each AA 1.5 V, we recommend only using the battery pack included in the standard equipment (pack of rechargeable batteries eneloop type AA HR6, 2000 mAh: article no. Z502H)
Number of measurements (standard setup with illumination)	
– For R _{ISO}	1 measurement – 25 s pause: Approx. 1100 measurements
– For R _{LO}	Automatic polarity reversal / 1 Ω (1 measuring cycle) – 25 s pause: Approx. 1000 measurements
Battery test	Symbolic display of rechargeable battery voltage BAT 
Battery saver circuit	Display illumination can be switched off. The test instrument is switched off automatically after the last key operation. The user can select the desired on-time.
Safety shutdown	If supply voltage is too low, the instrument is switched off, or cannot be switched on.

Recharging socket

Installed rechargeable batteries can be recharged directly by connecting a charger to the recharging socket:
MBASE/MTECH: Z502P

Charging time

MBASE/MTECH charger (Z502P):
Approx. 4 hours *

* Maximum charging time with fully depleted rechargeable batteries. A timer in the charger limits charging time to no more than 4 hours.

Overload Capacity

R _{ISO}	1200 V continuous
U _{L-PE} , U _{L-N}	600 V continuous
RCD, R _E , R _F	440 V continuous
Z _{L-PE} , Z _{L-N}	550 V (Limits the number of measurements and pause duration. If overload occurs, the instrument is switched off by means of a thermostatic switch.)
R _{LO}	Electronic protection prevents switching on if interference voltage is present
Fine-wire fuse protection	FF 3.15 A 10 s, fuses blow at > 5 A

Electrical Safety

Protection class	II per IEC 61010-1/EN 61010-1/ VDE 0411-1
Nominal voltage	230/400 V (300/500 V)
Test voltage	3.7 kV 50 Hz
Measuring category	CAT III 500 V or CAT IV 300 V
Pollution degree	2
Fusing, L and N terminals	1 cartridge fuse-link ea. FF 3.15/500G 6.3 x 32 mm

PROFITEST | MBASE MTECH

DIN VDE 0100/IEC 60364-6 Testers

Electromagnetic Compatibility (EMC)

Product standard EN 61326-1:2006

Interference emission		Class
EN 55022		A
Interference immunity	Test Value	Feature
EN 61000-4-2	Contact/atmos. – 4 kV/8 kV	
EN 61000-4-3	10 V/m	
EN 61000-4-4	Mains connection – 2 kV	
EN 61000-4-5	Mains connection – 1 kV	
EN 61000-4-6	Mains connection – 3 V	
EN 61000-4-11	0.5 period / 100%	

Ambient Conditions

Accuracy	0 to + 40 °C
Operation	–5 to + 50 °C
Storage	–20 to +60 °C (without rechargeable batteries)
Relative humidity	Max. 75%, no condensation allowed
Elevation	Max. 2000 m

Mechanical Design

Display	Multiple display with dot matrix, 128 x 128 pixels
Dimensions	W x L x D: 260 x 330 x 90 mm
Weight	MBASE/MTECH: approx. 2.3 kg with batteries
Protection	Housing: IP 40, test probe: IP 40 per EN 60529/DIN VDE 0470, part 1

Data Interfaces

Type	USB slave for PC connection
Type	RS 232 for barcode and RFID scanners

Scope of delivery:

- 1 Test instrument
- 1 Earthing contact plug insert (country-specific)
- 1 2-pole measuring adapter and 1 cable for expansion into a 3-pole adapter (PRO-A3-II)
- 2 Alligator clips
- 1 Shoulder strap
- 1 Set of rechargeable batteries (Z502H)
- 1 Battery charger: **MBASE/MTECH** (Z502P)
- 1 Condensed operating instructions
- 1 CD ROM with Operating instructions
- 1 DAkkS calibration certificate
- 1 USB cable

Special Functions with PROFITEST MTECH

Tripping Test for Type B, AC/DC Sensitive RCCBs with Rising DC Residual Current and Measurement of Tripping Current

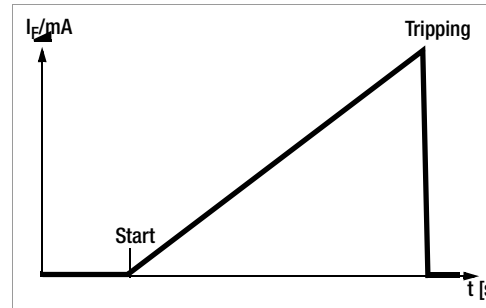

With the selector switch in the I_F position, slowly rising current flows via N and PE. The momentary measured current value is continuously displayed. When the RCCB is tripped, the last

measured current value is displayed. A greatly reduced rate of increase is used for delayed RCCBs (type **S**).

Tripping Test for Type B, AC/DC Sensitive RCCBs with Constant DC Residual Current and Measurement of Tripping Time

With the selector switch set to the respective nominal residual current, twice the selected nominal current flows via N and PE. Time to trip is measured for the RCCB and displayed.

Loop Resistance Measurement with Suppression of RCD Tripping

The test instruments make it possible to measure loop impedance in TN systems with type A, F and type AC RCCBs (10, 30, 100, 300, 500 mA nominal residual current).

The respective test instrument generates a DC residual current to this end, which saturates the RCCB's magnetic circuit. The test instrument then superimposes a measuring current which only demonstrates half-waves of like polarity. The RCCB is no longer capable of detecting this measuring current, and is consequently not tripped during measurement.

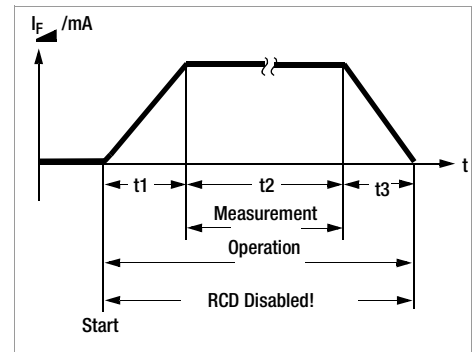

Selective Earthing Resistance Measurement (mains powered)

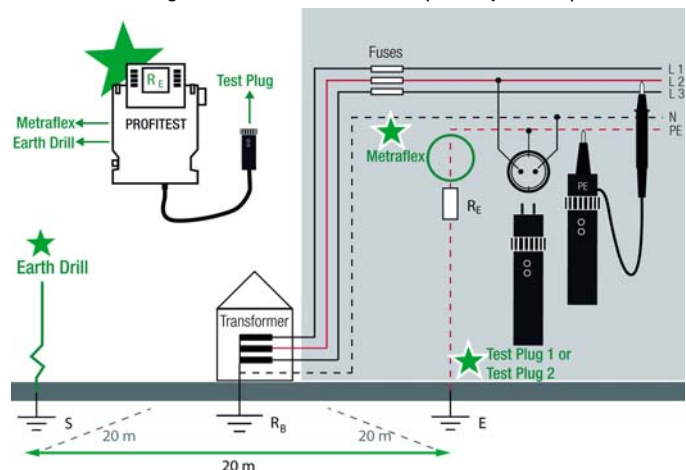

PROFITEST | MBASE MTECH DIN VDE 0100/IEC 60364-6 Testers

ETC User Software for PC (scope of delivery)

Creation of Individualized Test Structures at a PC and Transfer to the Test Instrument

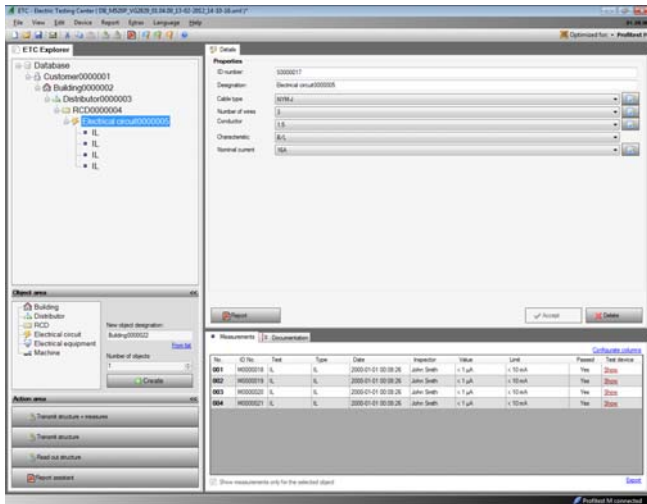

Editing of Selection Lists

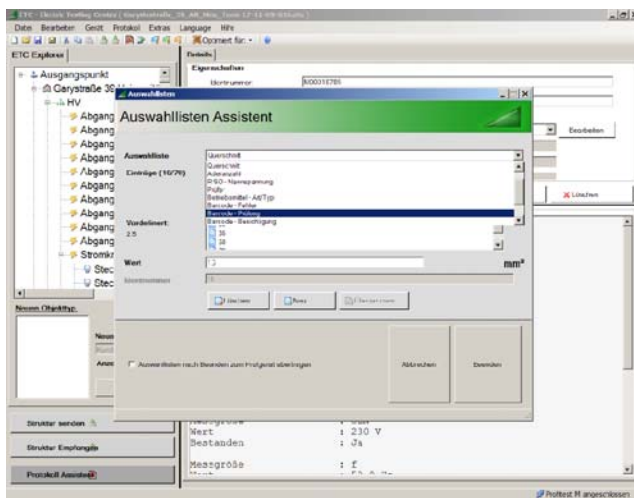

Report Generating

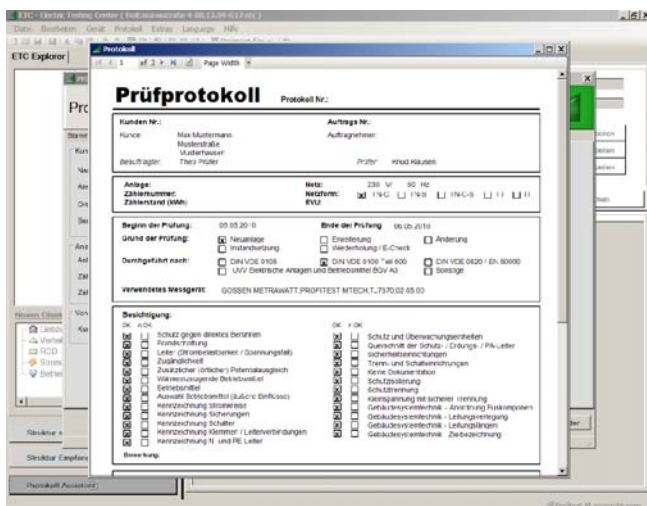

Report Generating Accessories

PROTOKOLLmanager Professional

Report generating software for documenting electrical tests in accordance with BGV A3, VDE 0100 and VDE 0701-0702 with unlimited customer management.

ELEKTROmanager

Software for measurement and documentation of electrical devices and electrical installations. ELEKTROmanager represents a new generation of software for data logging and data management, as well as for controlling test sequences used by electricians concerned with effectiveness, technical competence and legal security. Use is easy to learn and self-explanatory to a great extent. All common measuring instruments supplied by other manufacturers can be interconnected, i.e. after purchasing a new GMC-I Messtechnik GmbH instrument the customer can continue using an older instrument from another manufacturer.

PS3 Software for Test Instruments

PS3 reads in measurement data acquired with test instruments and organizes them automatically according to activity, i.e. testing, maintenance and inspection. Only a few quick work steps are required for the generation of ready-to-sign test reports and hand-over reports.

Standard requirements, for example reading in measurement data and report printing, are fulfilled with the basic module and the device module. Other requirements including following up on deadlines, test data history and selection of any desired data for generating lists, right on up to complete object management (equipment and buildings), are handled by the add-on module and any required additional modules.

Data can be exported from PS3 to the test instrument.

An overview of PS3's performance features can be accessed at our website.

Report and List Generation with PC.doc-WORD™/EXCEL™

Prerequisite: Microsoft®WORD™ or Microsoft®EXCEL™

PC.doc-WORD™/EXCEL™ inserts test results and data entered at the test instrument input module into report or list forms. These can then be supplemented and printed out with Microsoft®WORD™ or Microsoft®EXCEL™.

Test Data Management with PC.doc-ACCESS™

Prerequisite: PC.doc-ACCESS™

PC.doc-ACCESS™ manages device, machine, equipment, master and test data. Available test data are automatically entered to master data and test data lists which are assigned to individual customers.

Data are represented in accordance with the respective test regulation. Data are displayed as lists or in data sheet format, and can be sorted and filtered in a variety of different ways.

Complete test data management is thus made possible.

Reports and deadline lists can be printed out for selectable ID number ranges and dates.

PROFITEST | MBASE MTECH

DIN VDE 0100/IEC 60364-6 Testers

PROFISCAN ETC (ring binder with barcodes) – Z502G
Barcode scanner for connection to RS 232 port at tester – Z502F



Barcode and label printer for USB connection to a PC – Z721D

Barcode/label printer for connection to a PC, for self-adhesive, smudge-proof barcode labels, for identifying devices and system components. Devices and system components can be logged by our test instruments, and acquired measured values can be allocated to them with the scanner.



SCANBASE RFID reader for connection to RS 232 port at tester – Z751G



The Z751G RFID reader is preprogrammed to scan the following RFID tags.

Order No.	Frequency	Standard	Type	Quantity per Package
Z751R	13.56 MHz	ISO 15693	approx. 22 mm dia., self-adhesive	500 pieces
Z751S	13.56 MHz	ISO 15693	approx. 30 x 2 mm dia. with 3 mm hole	500 pieces
Z751T	13.56 MHz	ISO 15693	Pigeon ring, approx. 10 mm dia.	250 pieces

See separate ID systems data sheet regarding barcode scanners and printers, as well as RFID readers.

Power Supply Accessories

Z502H Master Battery Pack



With Jack Plug

Accessory Plug Inserts and Adapters

Country specific Plug Inserts
PRO-Schuko

PRO-W



Magnetic measuring contacts (Patent) with magnetic strain relief (Z502Z)

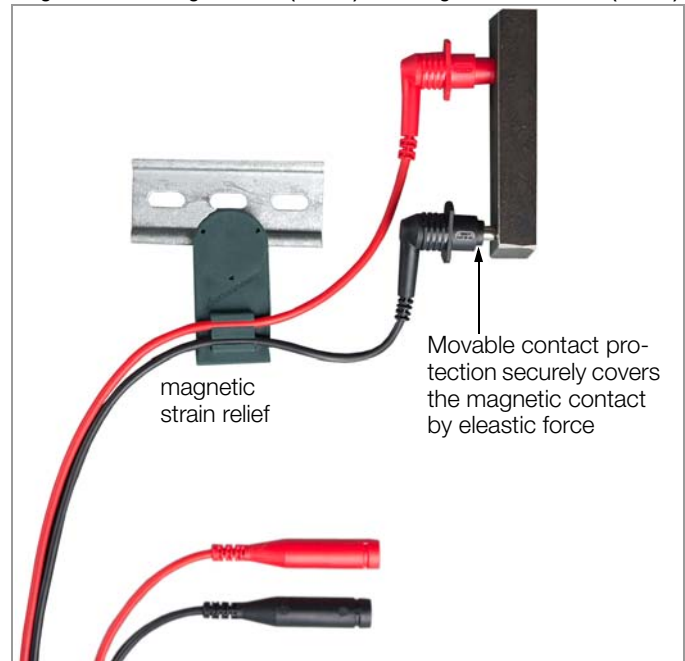

PROFITEST | MBASE MTECH

DIN VDE 0100/IEC 60364-6 Testers

PRO-RLO-II Plug Insert



PRO-UNI-II Plug Insert



ISO Calibrator 1

Calibration adapter for rapid, efficient testing of the accuracy of measuring instruments for insulation resistance and low-value resistors

Telearm1 Telescoping Rod



3-Phase Current Adapters



A3-16, A3-32 and A3-63 3-phase adapters are used for trouble-free connection of test instruments to 5-pole CEE outlets. The three variants differ with regard to plug size, which corresponds respectively to 5-pole CEE outlets with current ratings of 16, 32 and 63 A. Phase sequence is indicated with lamps at all three variants. Testing the effectiveness of safety

measures is conducted via five 4 mm contact protected sockets.

Floor Probe



The 1081 floor probe makes it possible to measure the resistance of insulating floors in accordance with DIN VDE 0100, part 600, and EN 1081.



WZ12C

Current clamp sensor for leakage current, selectable measuring ranges: 1 mA to 15 A, 3% and 1 A to 150 A, 2% Transformation ratios: 1 mV/mA, 1 mV/A

Variable Plug Adapter Set



Three self-retaining, contact protected test probes for the connection of measurement cables with 4 mm banana plugs, or with contact protected plugs for sockets with an opening of 3.5 mm to 12 mm, e.g. CEE, Perilex sockets etc. For example,

the test probes also fit the square PE jacks on Perilex sockets. Maximum allowable operating voltage: 600 V per IEC 61010.

METRAFLEX P300



Flexible current clamp sensor for selective earthing resistance measurement 3/30/300 A, 1 V/100 mV/10 mV/A

KS24 Cable Set



The KS24 cable set includes a 4 m long extension cable with a permanently attached test probe at one end and a contact protected socket at the other end, as well as an alligator clip which can be plugged onto the test probe.



Z3512A
AC Current Sensor Clamp

Switchable measuring ranges:
1 mA to 1/100/1000 A~

Transformation ratios:

1 V/A, 100mV/A, 10 mV/A, 1 mV/A

PROFITEST | MBASE MTECH

DIN VDE 0100/IEC 60364-6 Testers

Earthing Resistance Measurement Accessories

TR25 Reel



TR50 Drum with 50m Measurement Cable



50 m measurement cable coiled onto a metal drum. Connection to the inside end of the cable is made possible with a socket integrated into the drum. The other end is equipped with a banana plug. The drum axle with handle can be removed for space saving storage. Cable resistance can be compensated for with the rotary selector switch in the R_{LO} position.

SP350 Earth Drill



Accessory Cases and Trolleys

Ever-ready case for PROFITEST MASTER (Z502X)



SORTIMO L-BOXX GM (Z503D)



Plastic system case
Outside dimensions:
W x H x D
450 x 255 x 355 mm
Foam insert Z503E
for tester and accessories,
has to be ordered separately,
see below.

Foam insert for SORTIMO L-BOXX GM (Z503E)



Profi-Case (Z502B)



Outside dimensions:
H x W x D
390 x 590 x 230 mm



E-CHECK Case (Z502M)
Outside dimensions:
H x W x D
390 x 590 x 230 mm

Sample Contents



PROFITEST | MBASE MTECH

DIN VDE 0100/IEC 60364-6 Testers

F2000 Universal Carrying Pouch



Test instrument, plug inserts, measuring adapters, replacement batteries, recording charts etc. can be stored in a clear-cut fashion and conveniently transported in the F2000 carrying pouch.

Outside dimensions:
380 x 310 x 200 mm
(without buckles, handle and carrying strap)

F2020 Large Universal Carrying Pouch



Outside dimensions:
W x H x D
430 x 310 x 300 mm
(without buckles, handle and carrying strap)

Trolley for Profi-Case (Z502B) and E-CHECK Case (Z502N)

Folded-up dimensions: 395 x 150 x 375 mm



Order Information

Designation	Type	Article Number
PROFITEST MASTER Instrument Variants		
Universal protective measure test instruments for DIN VDE 0100 per EN 61557, parts 1, 2, 3, 4, 5, 6, 7 and 10 with integrated memory and insulation measurement up to 1000 V, mains powered earthing resistance measurements. See page 2 for a detailed overview of performance features and page 6 for scope of delivery.		
Basic Instrument	PROFITEST MBASE	M520M
Same as basic instrument plus the following special functions: – (Rechargeable) battery powered measurements: Earthing resistance (3/4-wire) Soil resistivity Selective earthing resistance Earth loop resistance – Automatic test sequence function	PROFITEST MPRO *	M520M *
Same as basic instrument plus the following special functions: – Tripping test for AC/DC sensitive RCDs and loop impedance measurement without tripping the RCD	PROFITEST MTECH	M5200
Same as basic instrument plus numerous special functions: – Tripping test for AC/DC sensitive RCDs and loop impedance measurement without tripping the RCD – Testing of IMDs – Testing of RCMs per EN 61557, part 11 – (Rechargeable) battery powered measurements: Earthing resistance (3/4-wire) Soil resistivity Selective earthing resistance Earth loop resistance – Leakage current measurement – Residual voltage test – Intelligent ramp – Automatic test sequence function – <i>Bluetooth</i> [®] interface	PROFITEST MXTTRA *	M520P *
* see data sheet PROFITEST MPRO MXTTRA (3-349-646-03)		
Test Instrument Power Supply Accessories		
8 LSD NiMH rechargeable batteries with reduced self-discharging (AA) (eneloop/Sanyo), 2000 mAh with sealed cells	MASTER Battery Set	Z502H
Broad-range charger for charging batteries included in the PROFITEST MBASE MTECH Input: 100 to 240 V AC Output: 16.5 V DC, 0.6 A	PROFITEST MASTER MBASE MTECH Charger	Z502P
Accessory Plug Inserts and Adapters		
Earth contact plug insert (Schuko): D, A, NL, F etc.	PRO-Schuko	GTZ3228000R0001
same as PRO-Schuko, however with angled earth-contact plug	PRO-W	Z503A
Plug insert per SEV: CH	PRO-CH	GTZ3225000R0001
Plug insert with adapters for GB & USA	PRO-GB/USA-Set	Z503B
Plug insert for South Africa	PRO-RSA	Z501A
2/3-pole measuring adapter for 3-phase and rotating-field systems, 300 V/1 A CAT IV with safety cap 600 V/1 A CAT III with safety cap 600 V/16 A CAT II without safety cap	PRO-A3-II	Z5010
same as PRO-A3-II, however with straight cables of 10 m each instead of coil cables	PRO-A3-II ncc	Z503C
With 10 m cable based on 2-wire measuring technology for PE and similar measurements, 300 V / 16 A CAT IV	PRO-RLO-II	Z501P

PROFITEST | MBASE MTECH

DIN VDE 0100/IEC 60364-6 Testers

Designation	Type	Article Number
With 3 connector cables for any connection standards, 300 V / 16 A, CAT IV	PRO-UNI-II	Z501R
2 magnetic measurement contacts with contact protection – Set with magnetic holder, measurement contacts 5,5 mm in diameter insulated, CAT III 1.000 V / 4 A, temperature between –10 °C and 60 °C, under standard conditions and flat-head screws holding force 1.200 g vertical to contact area; measuring instrument connector: 4 mm sockets for PRO-A3-II	Set 3 – Magn. Measuring Tips	Z502Z
5-pole 3-phase adapter for 16 A CEE outlets	A3-16	GTZ3602000R0001
5-pole 3-phase adapter for 32 A CEE outlets	A3-32	GTZ3603000R0001
5-pole 3-phase adapter for 63 A CEE outlets	A3-63	GTZ3604000R0001
Variable Plug Adapter Set	Z500A	Z500A
Calibration adapter for testing of the accuracy of measuring instruments for insulation resistance and low-value resistors	ISO Calibrator 1	M662A
Accessories		
Extension cable, 4 m	KS24	GTZ3201000R0001
Telescoping rod for PE measurement	Telearm 1	GTZ3232000R0001
Triangular probe for floor measurements in accordance with EN 1081 and DIN VDE 0100	1081 Probe	GTZ3196000R0001
Current clamp sensor for leakage current, switchable: 1 mA to 15 A, 3% and 1 A to 150 A, 2%	WZ12C ^D	Z219C
Flexible AC current sensor, 3, 30, 300 A, 1 V, 100 mV, 10 mV / A, with batteries, probe length: 45 cm	METRAFLEX P300	Z502E
Earthing Resistance Measurement Accessories		
Current clamp sensor for selective earth measurement and as clamp meter for 2-clamp measuring method (ground loop measurement), switchable measuring ranges: 0 to 1/100/1000 A~ AV~ ± (0.7% to 0.2%)	Z3512A ^D	Z225A
Reel with 25 m measurement cable	TR25 Reel	GTZ3303000R0001
Drum with 50 m measurement cable	TR50 Drum	GTY1040014E34
Earth drill, 35 cm long, for earth measurement	SP350 Earth Drill	GTZ3304000R0001
Accessory Cases and Trolleys		
Ever-ready case with bags for accessories	Ever-ready Case PROFITEST MASTER	Z502X
Stackable case, empty, with inserts for PROFITEST MASTER and accessories	Instrument Master Case	Z502A
Aluminum case for test instrument and accessories	E-CHECK Case	Z502M
The E-CHECK case can be mounted to the trolley.	Trolley for E-CHECK Case	Z502N
Universal carrying pouch	F2000 ^D	Z700D
Large universal carrying pouch	F2020	Z700F
Plastic system case	SORTIMO L-BOXX GM	Z503D
Foam insert for SORTIMO L-BOXX GM with divider for PROFITEST MASTER	Foam SORTIMO L-BOXX Profitest M	Z503E

Designation	Type	Article Number
Profi-hardcase with imprint and dividers for sets with Profitest Master and accessories incl. trolleyholder	Profi-Case	Z502W
Starter Packages		
Consisting of PROFITEST MBASE, variable plug adapter set and F2000 universal carrying pouch	BASE Starter Package	M500M
Consisting of PROFITEST MTECH, variable plug adapter set and plastic system case SORTIMO L-BOXX GM with foam insert	TECH Starter Package	M500N
Consisting of PROFITEST MTECH, variable plug adapter set, SP350 earth spike, TR50 metal drum, PRO-RLO II adapter and instrument master case (Z502A)	TECH Master Package	M500P
Consisting of PROFITEST MTECH, variable plug adapter set and E-CHECK case	E-CHECK Set	M500U
Consisting of PROFITEST MXTRA, VARIO-STECKER-Set, plastic system case SORTIMO L-BOXX GM with foam insert, MASTER Battery Set and MPRO MXTRA Charger	XTRA Starter Package	M500V
Consisting of PROFITEST MXTRA, VARIO-STECKER-Set, Profi Case, PRO-RLO-II, MASTER Battery Set and MPRO MXTRA Charger	XTRA Master Package	M500W
Consisting of PROFITEST MXTRA, VARIO-STECKER-Set, Profi Case, leakage current measuring adapter PRO-AB, MASTER Battery Set and MPRO MXTRA Charger	XTRA MED Package	M500X
Consisting of PROFITEST MXTRA, VARIO-STECKER-Set, Profi Case, generator clamp E-Clip 2 and Current clamp sensor for earth measurement Z3512A, measuring adapter for connecting a second clamp PRO-RE-2, MASTER Battery Set and MPRO MXTRA Charger	XTRA Profi Package	M500Y
Report Generating Accessories		
See separate ID systems data sheet regarding barcode scanners/printers and RFID readers.		
Barcode scanner for RS 232 connection with roughly 1 m coil cable	RS 232 Profiscanner for Barcodes	Z502F
Ring binder with preprinted barcodes for scanning (German)	PROFISCAN ETC D	Z502G
RFID reader/writer	SCANBASE RFID	Z751G
PC analysis software		
Further information regarding software is available on the Internet at:		
http://www.gossenmetrawatt.com (→ Products → Electrical Testing → Testing of Electr. Installations → PROFITEST MASTER)		
or		
http://www.gossenmetrawatt.com (→ Products → Software → Software for Testers)		

^D Data sheet available

Edited in Germany • Subject to change without notice • PDF version available on the Internet

 GOSSEN METRAWATT

GMC-I Messtechnik GmbH
Südwestpark 15
90449 Nürnberg • Germany

Phone: +49 911 8602-111
Fax: +49 911 8602-777
E-mail: info@gossenmetrawatt.com
www.gossenmetrawatt.com