

Datasheet

Fibre Optic Cable Assembly, Multi-Mode

RS Stock number 536-6743

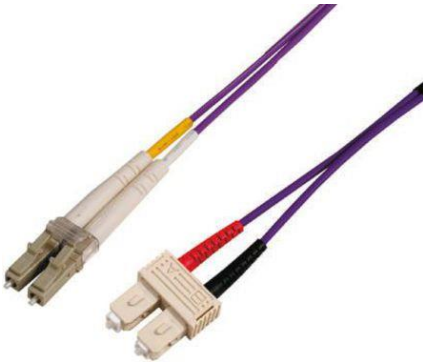

Dimensions: (mm)

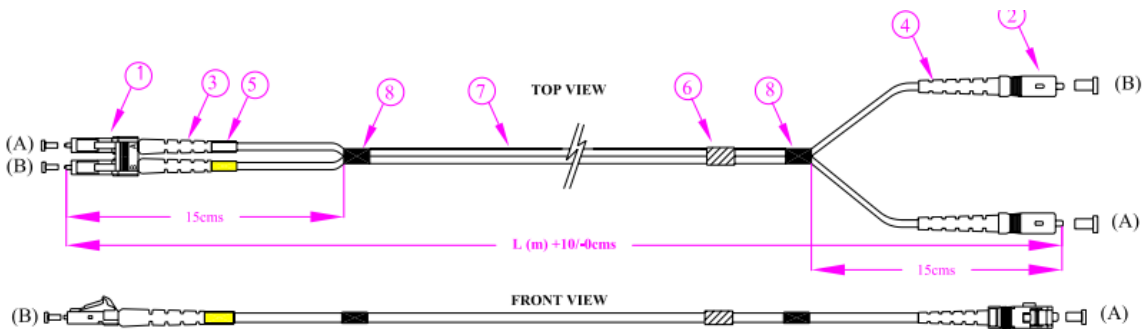

Optical Performance (IEC 61300-3-4):

Multimode (@ 1300nm)

LC : Max. IL - 0.30dB Typical: 0.20dB

Singlemode: (@1310nm and/or 1550nm)

LC : Max. IL - 0.30dB Typical: 0.20dB Return Loss: >50dB

Connector: LC clips shall be mounted on to the connector to make it duplex.

Coiling Diameter: Coiling Diameter of the patchcord shall be greater than 200mm

Id No.	Description	Ea
1.	LC Connector	2
2.	SC Connector	2
3.	LC Boots	2
4.	SC Boots	2
5.	LC Heat Shrink (Yellow+White)	1+1
6.	Identification Label	1
7.	1.6mm Duplex Cable (L m)	1
8.	Black Tape	2