

## LM4040

### PRECISION MICROPOWER SHUNT VOLTAGE REFERENCES

#### Description

The LM4040 is a family of bandgap circuits designed to achieve precision micro-power voltage references of 2.5V, 3.0V and 5.0V. The devices are available in 0.2% B-grade, 0.5% C-grade and 1% D-grade initial tolerances.

They are available in small outline SOT23 and SC70-5 surface mount packages which are ideal for applications where space is at a premium.

Excellent performance is maintained over the 60µA to 15mA operating current range with a typical temperature coefficient of only 20ppm/°C. The device has been designed to be highly tolerant of capacitive loads so maintaining excellent stability.

This device offers a pin for pin compatible alternative to the LM4040 voltage reference.

#### Features

- Small packages: SOT23 & SC70-5
- No output capacitor required
- Output voltage tolerance
  - LM4040B ±0.2% at 25°C
  - LM4040C ±0.5% at 25°C
  - LM4040D ±1% at 25°C
- Low output noise
- (10Hz to 10kHz) ..... 45µV<sub>RMS</sub>
- Wide operating current range 60µA to 15mA
- Extended temperature range -40°C to +125°C
- Low temperature coefficient 100 ppm/°C (max)

#### Applications

- Battery powered equipment
- Precision power supplies
- Portable instrumentation
- Portable communications devices
- Notebook and palmtop computers
- Data acquisition systems

#### Pin Assignments

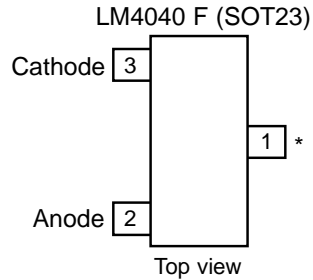

\* Pin 1 must be left floating or connected to pin 2

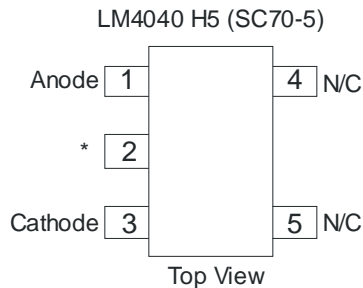

\* Pin 2 must be left floating or connected to pin 1

### Absolute Maximum Ratings (Voltages to GND Unless Otherwise Stated)

Parameter	Rating	Unit
Continuous Reverse Current	20	mA
Continuous Forward Current	10	mA
Operating Junction Temperature	-40 to 150	°C
Storage Temperature	-55 to 150	°C

Operation above the absolute maximum rating may cause device failure. Operation at the absolute maximum rating, for extended periods, may reduce device reliability.

Unless otherwise stated voltages specified are relative to the ANODE pin.

### Package Thermal Data

Package	$\theta_{JA}$	$P_{DIS}$ $T_{AMB} = 25^{\circ}C, T_J = 150^{\circ}C$
SOT23	380°C/W	330mW
SC70-5	380°C/W	330mW

### Recommended Operating Conditions

	Min.	Max.	Units
Reverse Current	0.06	15	mA
Operating Ambient Temperature Range	-40	125	°C

### Electrical Characteristics (Test conditions: $T_{amb} = 25^{\circ}C$ , unless otherwise specified.)

#### LM4040-2.5

Symbol	Parameter	Conditions		Typ.	LM4040 B Limits	LM4040 C Limits	LM4040 D Limits	Units	
		$I_R$	$T_{AMB}$						
$V_{REF}$	Reverse breakdown voltage	$I_R = 100\mu A$	25°C	2.5				V	
	Reverse breakdown voltage tolerance	$I_R = 100\mu A$	25°C -40 to 85°C -40 to 125°C		±5 ±21 ±30	±12 ±29 ±38	±25 ±49 ±63	mV	
$I_{RMIN}$	Minimum operating current		25°C -40 to 85°C -40 to 125°C	45	60 65 68	60 65 68	65 70 73	µA	
		$\Delta V_R/\Delta T$	Average reverse breakdown voltage temperature coefficient	$I_R = 10mA$	-40 to 125°C	±20 ±15 ±15	±100 ±100	±150	ppm/°C
				$I_R = 1mA$					
$I_R = 100\mu A$									
$\Delta V_R/\Delta I_R$	Reverse breakdown change with current	$I_{RMIN} < I_R < 1mA$	25°C	2.5	0.8 1.0 1.0	0.8 1.0 1.0	1.0 1.2 1.2	mV	
			-40 to 85°C						
			-40 to 125°C						
		$1mA < I_R < 15mA$	25°C	8.0 8.0 8.0	6.0 8.0 8.0	6.0 8.0 10.0	8.0 10.0 10.0		
			-40 to 85°C						
			-40 to 125°C						
$Z_R$	Dynamic output impedance	$I_R = 1mA, f = 120Hz$ $I_{AC} = 0.1I_R$		0.3	0.8	0.9	1.1	Ω	
$e_n$	Noise voltage	$I_R = 100\mu A$ 10Hz < f < 10kHz		35				µV <sub>RMS</sub>	
$V_R$	Long term stability (non cumulative)	t = 1000Hrs $I_R = 100\mu A$		120				ppm	
$V_{HYST}$	Thermal hysteresis	$\Delta T = -40^{\circ}C$ to $=125^{\circ}C$		0.08				%	

**Electrical Characteristics (Continued)** (Test conditions:  $T_{amb} = 25^{\circ}\text{C}$ , unless otherwise specified.)

**LM4040-3.0**

Symbol	Parameter	Conditions		Typ.	LM4040 B Limits	LM4040 C Limits	LM4040 D Limits	Units
			$T_{AMB}$					
$V_{REF}$	Reverse breakdown voltage	$I_R = 100\mu\text{A}$	$25^{\circ}\text{C}$	3.0				V
	Reverse breakdown voltage tolerance	$I_R = 100\mu\text{A}$	$25^{\circ}\text{C}$		$\pm 6$	$\pm 15$	$\pm 30$	mV
			$-40$ to $85^{\circ}\text{C}$		$\pm 26$	$\pm 34$	$\pm 59$	
			$-40$ to $125^{\circ}\text{C}$		TBD	$\pm 45$	$\pm 75$	
$I_{RMIN}$	Minimum operating current		$25^{\circ}\text{C}$	47	62	62	67	$\mu\text{A}$
			$-40$ to $85^{\circ}\text{C}$		67	67	72	
			$-40$ to $125^{\circ}\text{C}$		70	70	75	
$\Delta V_R/\Delta T$	Average reverse breakdown voltage temperature coefficient	$I_R = 10\text{mA}$	$-40$ to $125^{\circ}\text{C}$	$\pm 20$				ppm/ $^{\circ}\text{C}$
		$I_R = 1\text{mA}$		$\pm 15$	$\pm 100$	$\pm 100$	$\pm 150$	
		$I_R = 100\mu\text{A}$		$\pm 15$				
$\Delta V_R/\Delta I_R$	Reverse breakdown change with current	$I_{RMIN} < I_R < 1\text{mA}$	$25^{\circ}\text{C}$	0.4	0.8	0.8	1.0	mV
			$-40$ to $85^{\circ}\text{C}$		1.1	110	1.3	
			$-40$ to $125^{\circ}\text{C}$		1.1	1.1	1.3	
		$1\text{mA} < I_R < 15\text{mA}$	$25^{\circ}\text{C}$	2.7	6.0	6.0	8.0	
			$-40$ to $85^{\circ}\text{C}$		9.0	9.0	11.0	
			$-40$ to $125^{\circ}\text{C}$		9.0	9.0	11.0	
$Z_R$	Dynamic output impedance	$I_R = 1\text{mA}, f = 120\text{Hz}$ $I_{AC} = 0.1I_R$		0.4	0.9	0.9	1.2	$\Omega$
$e_n$	Noise voltage	$I_R = 100\mu\text{A}$ $10\text{Hz} < f < 10\text{kHz}$		35				$\mu\text{V}_{RMS}$
$V_R$	Long term stability (non cumulative)	$t = 1000\text{Hrs } I_R = 100\mu\text{A}$		120				ppm
$V_{HYST}$	Thermal hysteresis	$\Delta T = -40^{\circ}\text{C}$ to $=125^{\circ}\text{C}$		0.08				%

**LM4040-5.0**

Symbol	Parameter	Conditions		Typ.	LM4040 B Limits	LM4040 C Limits	LM4040 D Limits	Units
			$T_{AMB}$					
$V_{REF}$	Reverse breakdown voltage	$I_R = 100\mu\text{A}$	$25^{\circ}\text{C}$	5.0				V
	Reverse breakdown voltage tolerance	$I_R = 100\mu\text{A}$	$25^{\circ}\text{C}$		$\pm 10$	$\pm 25$	$\pm 50$	mV
			$-40$ to $85^{\circ}\text{C}$		$\pm 43$	$\pm 58$	$\pm 99$	
			$-40$ to $125^{\circ}\text{C}$		$\pm 60$	$\pm 75$	$\pm 125$	
$I_{RMIN}$	Minimum operating current		$25^{\circ}\text{C}$	54	74	74	79	$\mu\text{A}$
			$-40$ to $85^{\circ}\text{C}$		80	80	85	
			$-40$ to $125^{\circ}\text{C}$		83	83	88	
$\Delta V_R/\Delta T$	Average reverse breakdown voltage temperature coefficient	$I_R = 10\text{mA}$	$-40$ to $125^{\circ}\text{C}$	$\pm 30$				ppm/ $^{\circ}\text{C}$
		$I_R = 1\text{mA}$		$\pm 20$	$\pm 100$	$\pm 100$	$\pm 150$	
		$I_R = 100\mu\text{A}$		$\pm 20$				
$\Delta V_R/\Delta I_R$	Reverse breakdown change with current	$I_{RMIN} < I_R < 1\text{mA}$	$25^{\circ}\text{C}$	0.5	1.0	1.0	1.3	mV
			$-40$ to $85^{\circ}\text{C}$		1.4	1.4	1.8	
			$-40$ to $125^{\circ}\text{C}$		1.4	1.4	1.8	
		$1\text{mA} < I_R < 15\text{mA}$	$25^{\circ}\text{C}$	3.5	8.0	8.0	10.0	
			$-40$ to $85^{\circ}\text{C}$		12.0	12.0	15.0	
			$-40$ to $125^{\circ}\text{C}$		12.0	12.0	15.0	
$Z_R$	Dynamic output impedance	$I_R = 1\text{mA}, f = 120\text{Hz}$ $I_{AC} = 0.1I_R$		0.5	1.1	1.1	1.5	$\Omega$
$e_n$	Noise voltage	$I_R = 100\mu\text{A}$ $10\text{Hz} < f < 10\text{kHz}$		80				$\mu\text{V}_{RMS}$
$V_R$	Long term stability (non cumulative)	$t = 1000\text{Hrs } I_R = 100\mu\text{A}$		120				ppm
$V_{HYST}$	Thermal hysteresis	$\Delta T = -40^{\circ}\text{C}$ to $=125^{\circ}\text{C}$		0.08				%

**Typical Characteristics LM4040-2.5**

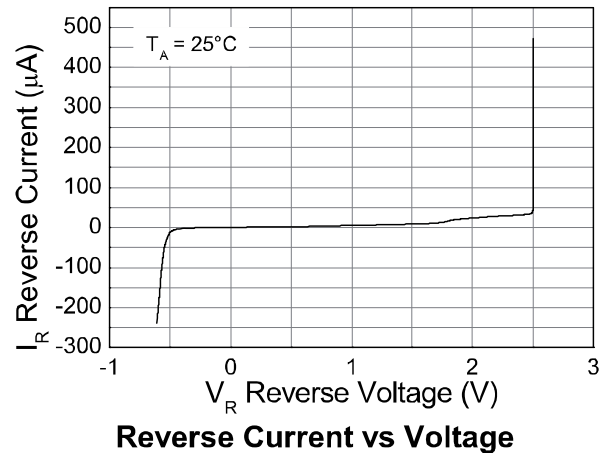
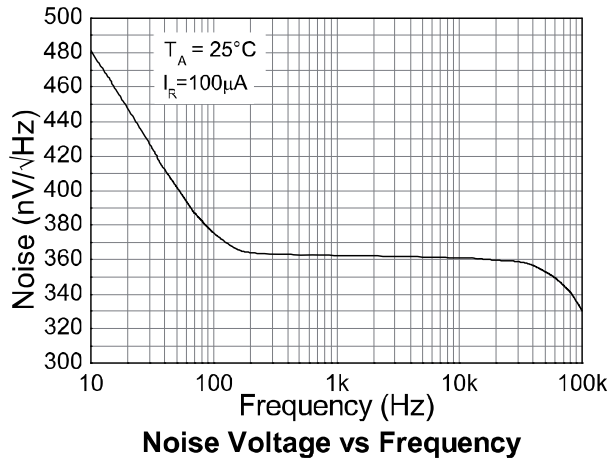
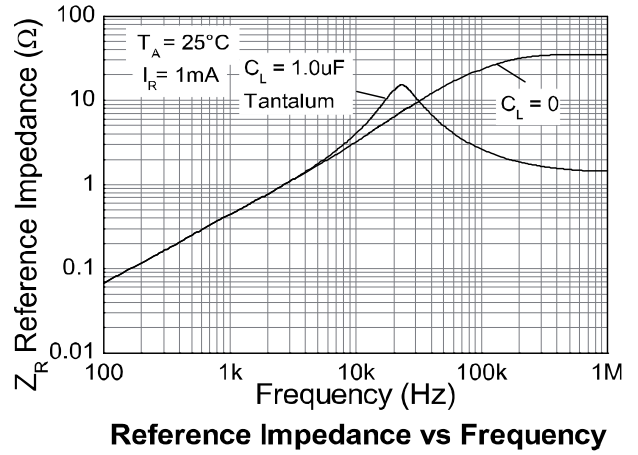
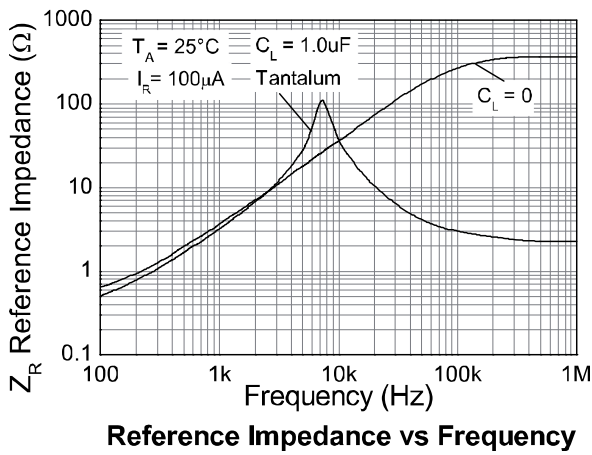
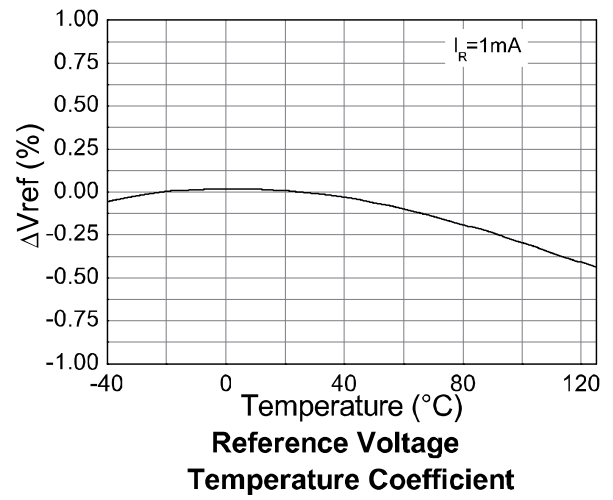
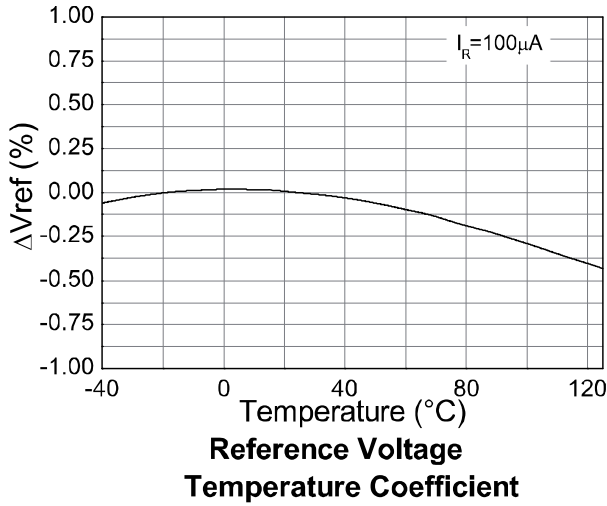

**Typical Characteristics LM4040-3.0**

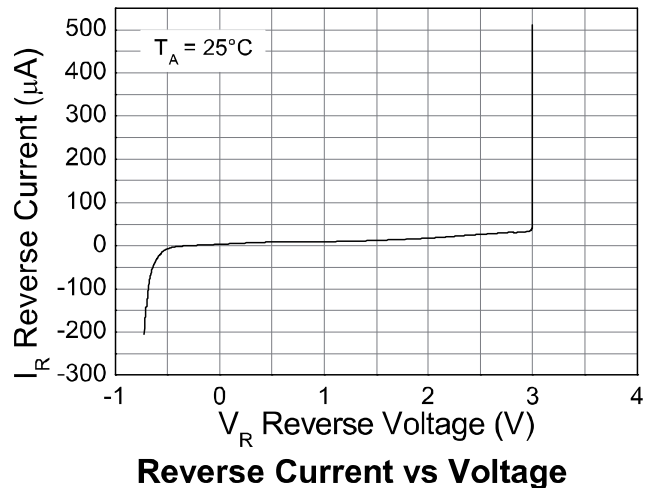
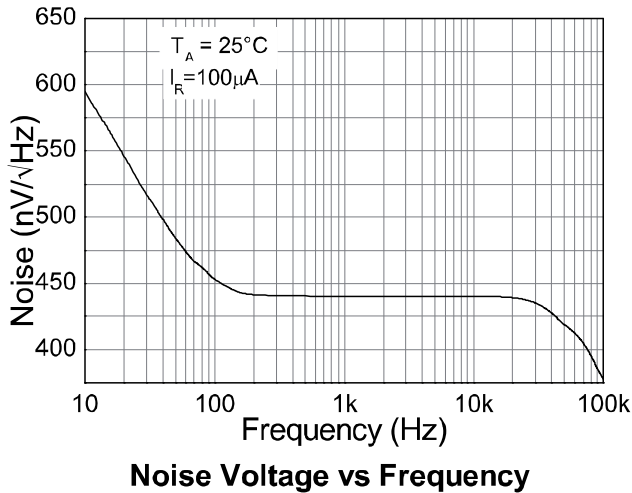
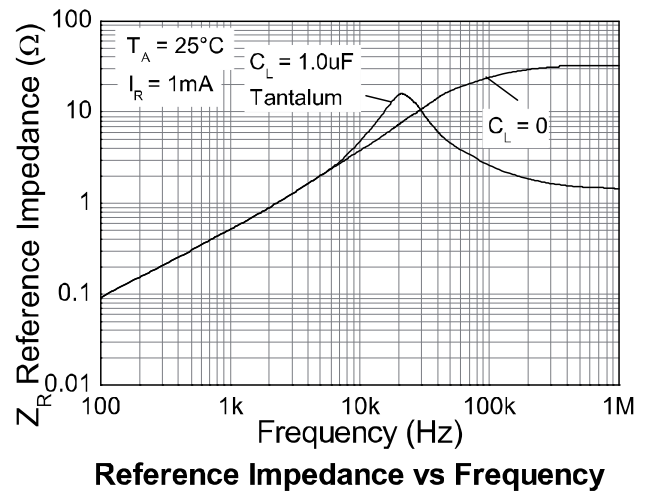
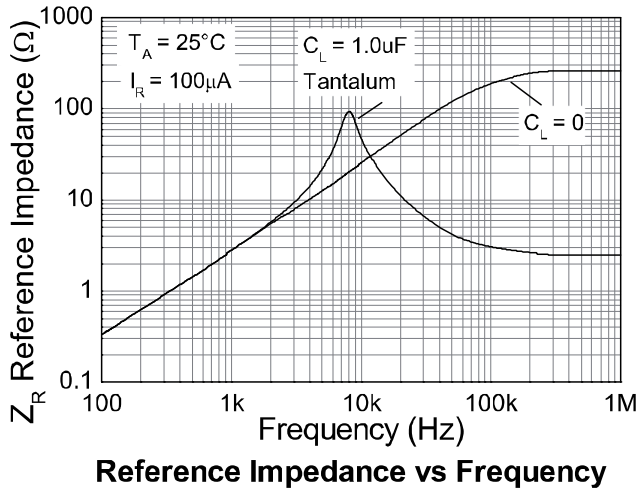
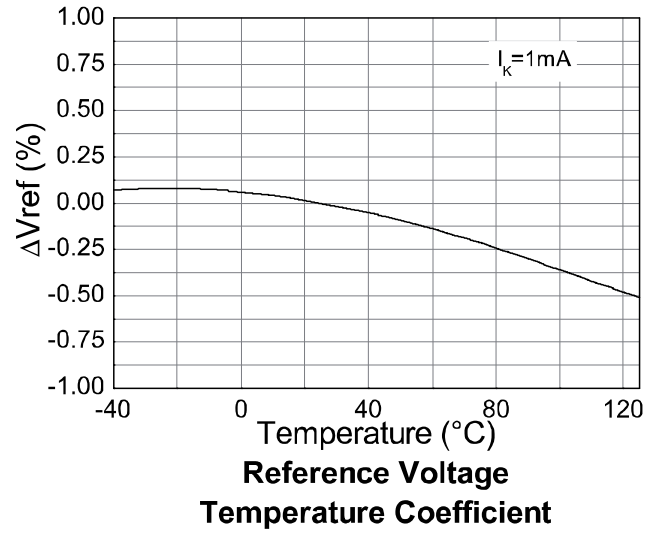
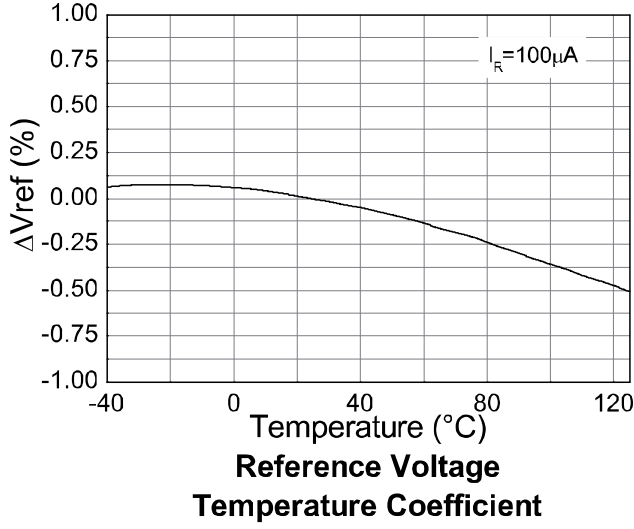

**Typical Characteristics LM4040-5.0**

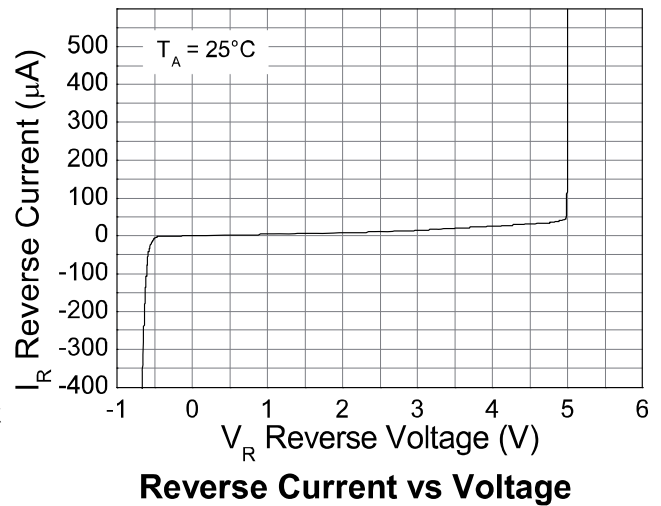
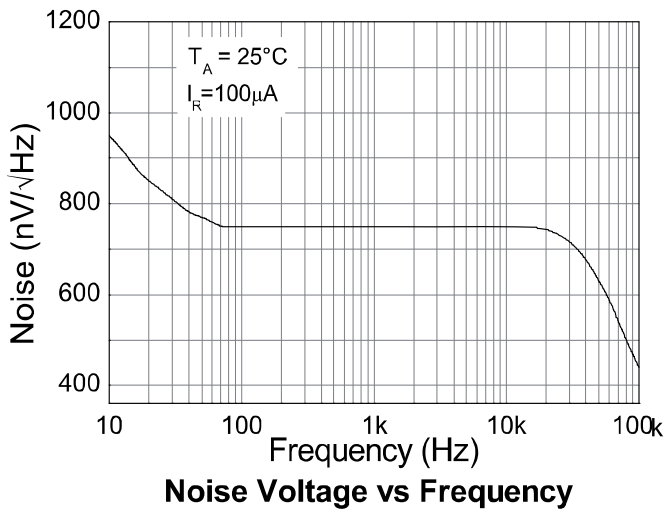
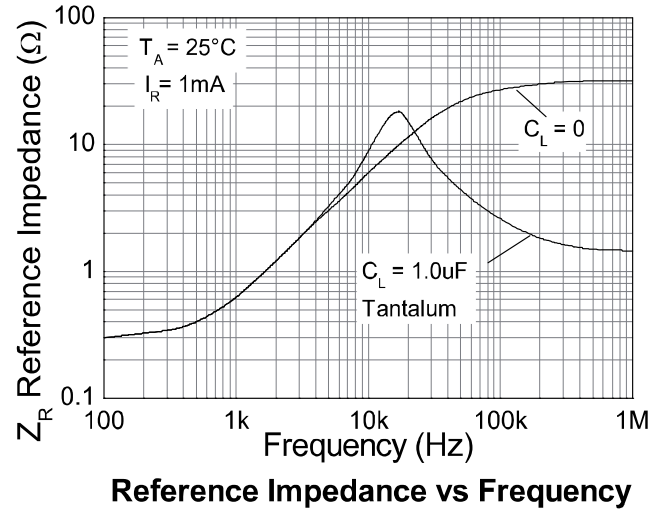
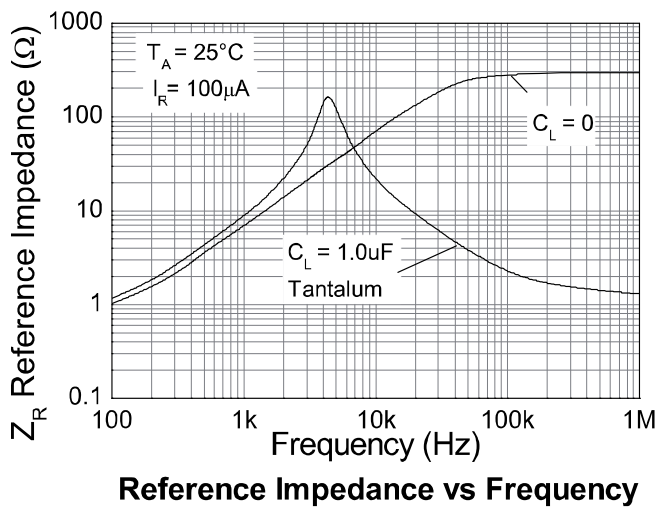
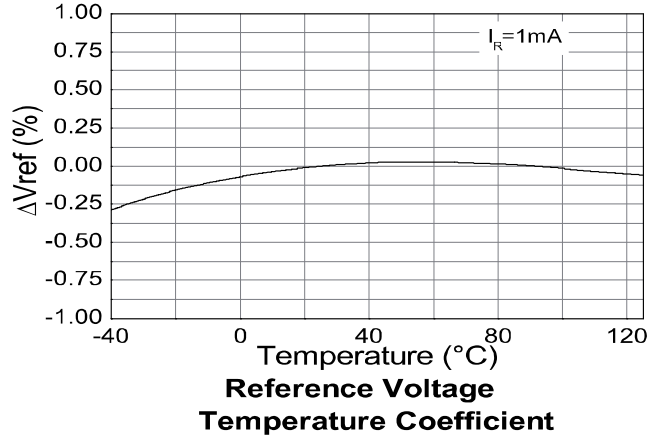
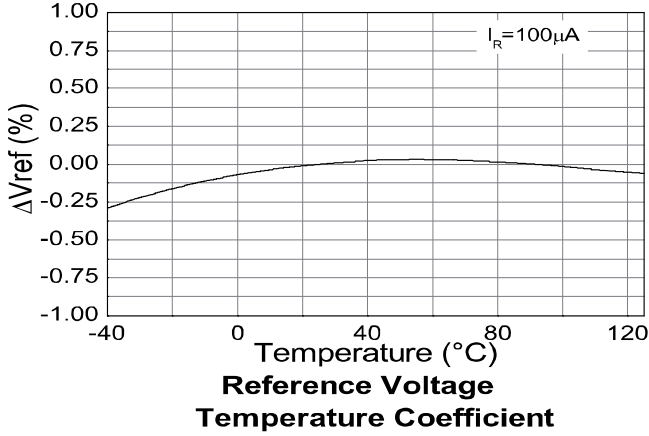

**Start Up Characteristics LM4040-2.5, 3.0 and 5.0**

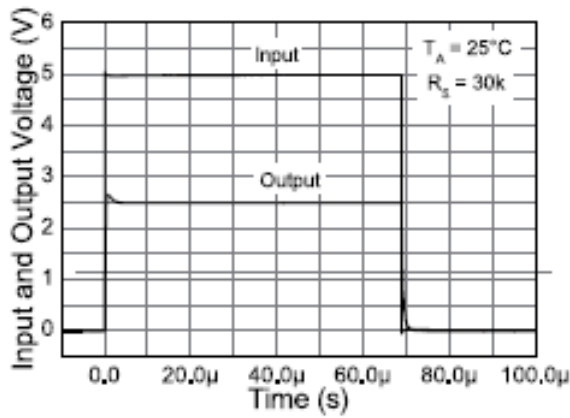

**Long Pulse Response**

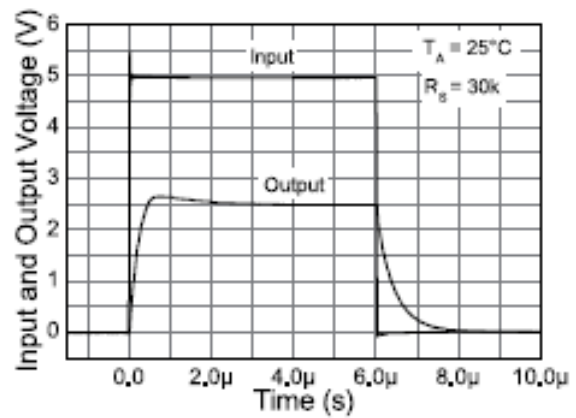

**Short Pulse Response**

**LM4040-3.0**

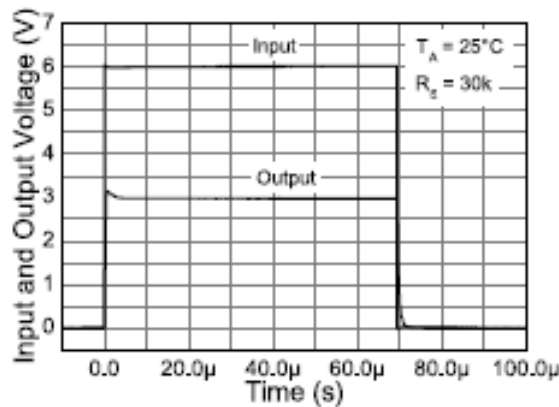

**Long Pulse Response**

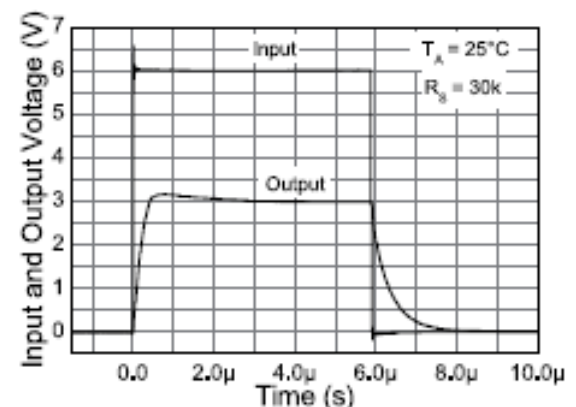

**Short Pulse Response**

**LM4040-5.0**

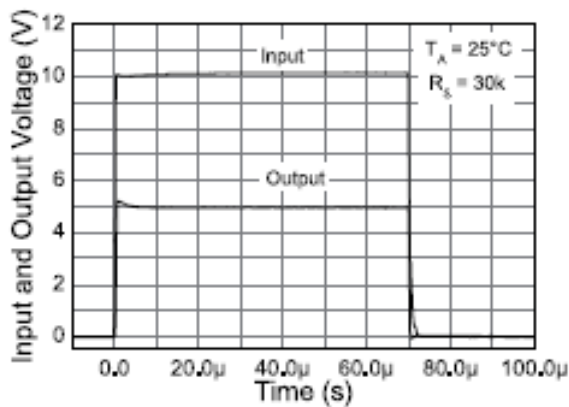

**Long Pulse Response**

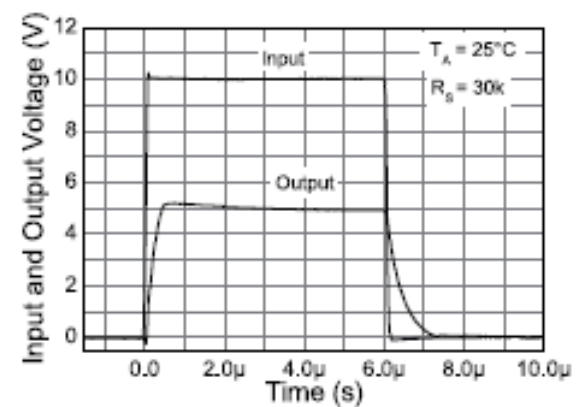

**Short Pulse Response**

## Application Information

In a conventional shunt regulator application (*Figure 1*), an external series resistor ( $R_S$ ) is connected between the supply voltage,  $V_S$ , and the LM4040.

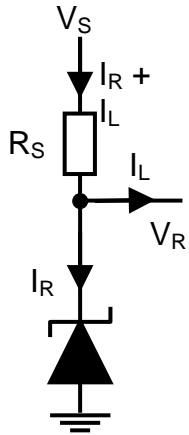

$R_S$  determines the current that flows through the load ( $I_L$ ) and the LM4040 ( $I_R$ ). Since load current and supply voltage may vary,  $R_S$  should be small enough to supply at least the minimum acceptable  $I_R$  to the LM4040 even when the supply voltage is at its minimum and the load current is at its maximum value. When the supply voltage is at its maximum and  $I_L$  is at its minimum,  $R_S$  should be large enough so that the current flowing through the LM4040 is less than 15 mA.

$R_S$  is determined by the supply voltage, ( $V_S$ ), the load and operating current, ( $I_L$  and  $I_R$ ), and the LM4040's reverse breakdown voltage,  $V_R$ .

$$R_S = \frac{V_S - V_R}{I_L + I_R}$$

### Printed circuit board layout considerations

LM4040s in the SOT23 package have the die attached to pin 1, which results in an electrical contact between pin 2 and pin 3. Therefore, pin 1 of the SOT-23 package must be left floating or connected to pin 2.

LM4040s in the SC70-5 package have the die attached to pin 2, which results in an electrical contact between pin 2 and pin 1. Therefore, pin 2 must be left floating or connected to pin1.

## Ordering Information

25°C Tol	Voltage (V)	Order Code	Package	Part Mark	Reel Size	Tape Width	Quantity per Reel
0.2%	2.5	LM4040B25FTA	SOT23	R2B	7", 180mm	8mm	3000
		LM4040B25H5TA	SC70-5	R2B	7", 180mm	8mm	3000
	3.0	LM4040B30FTA	SOT23	R3B	7", 180mm	8mm	3000
		LM4040B30H5TA	SC70-5	R3B	7", 180mm	8mm	3000
	5.0	LM4040B50FTA	SOT23	R5B	7", 180mm	8mm	3000
		LM4040B50H5TA	SC70-5	R5B	7", 180mm	8mm	3000
0.5%	2.5	LM4040C25FTA	SOT23	R2C	7", 180mm	8mm	3000
		LM4040C25H5TA	SC70-5	R2C	7", 180mm	8mm	3000
	3.0	LM4040C30FTA	SOT23	R3C	7", 180mm	8mm	3000
		LM4040C30H5TA	SC70-5	R3C	7", 180mm	8mm	3000
	5.0	LM4040C50FTA	SOT23	R5C	7", 180mm	8mm	3000
		LM4040C50H5TA	SC70-5	R5C	7", 180mm	8mm	3000
1%	2.5	LM4040D25FTA	SOT23	R2D	7", 180mm	8mm	3000
		LM4040D25H5TA	SC70-5	R2D	7", 180mm	8mm	3000
	3.0	LM4040D30FTA	SOT23	R3D	7", 180mm	8mm	3000
		LM4040D30H5TA	SC70-5	R3D	7", 180mm	8mm	3000
	5.0	LM4040D50FTA	SOT23	R5D	7", 180mm	8mm	3000
		LM4040D50H5TA	SC70-5	R5D	7", 180mm	8mm	3000



**Package Outline Dimensions**

**SOT23**

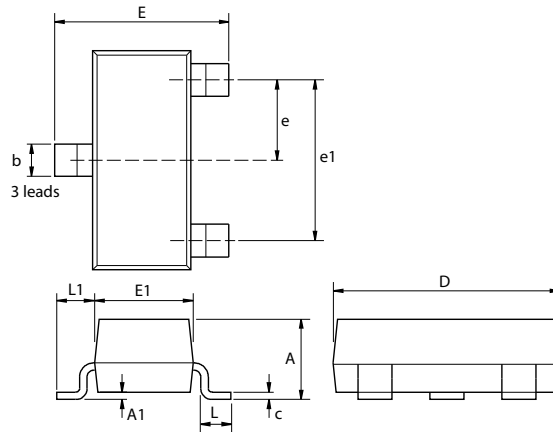

Dim.	Millimeters		Inches		Dim.	Millimeters		Inches	
	Min	Max	Min	Max		Min	Max	Min	Max
A	-	1.12	-	0.044	e1	1.90 NOM		0.075 NOM	
A1	0.01	0.10	0.0004	0.004	E	2.10	2.64	0.083	0.104
b	0.30	0.50	0.012	0.020	E1	1.20	1.40	0.047	0.055
c	0.085	0.20	0.003	0.008	L	0.25	0.60	0.0098	0.0236
D	2.80	3.04	0.110	0.120	L1	0.45	0.62	0.018	0.024
e	0.95 NOM		0.037 NOM		-	-	-	-	-

**Note:** Controlling dimensions are in millimeters. Approximate dimensions are provided in inches

**SC70-5**

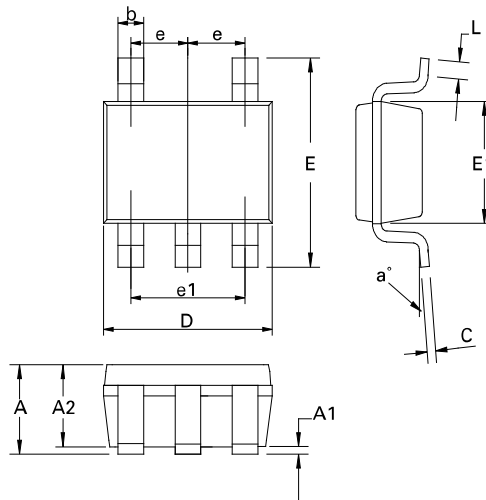

Dim.	Millimeters		Inches		Dim.	Millimeters		Inches	
	Min	Max	Min	Max		Min	Max	Min	Max
A	0.80	1.10	0.0315	0.0433	E	2.10 BSC		0.0826 BSC	
A1	-	0.10	-	0.0039	E1	1.25 BSC		0.0492 BSC	
A2	0.80	1.00	0.0315	0.0394	e	0.65 BSC		0.0255 BSC	
b	0.15	0.30	0.006	0.0118	e1	1.30 BSC		0.0511 BSC	
C	0.08	0.25	0.0031	0.0098	L	0.26	0.46	0.0102	0.0181
D	2.00 BSC		0.0787 BSC		a°	0	8	0	8

**Note:** Controlling dimensions are in millimeters. Approximate dimensions are provided in inches

**IMPORTANT NOTICE**

DIODES INCORPORATED MAKES NO WARRANTY OF ANY KIND, EXPRESS OR IMPLIED, WITH REGARDS TO THIS DOCUMENT, INCLUDING, BUT NOT LIMITED TO, THE IMPLIED WARRANTIES OF MERCHANTABILITY AND FITNESS FOR A PARTICULAR PURPOSE (AND THEIR EQUIVALENTS UNDER THE LAWS OF ANY JURISDICTION).

Diodes Incorporated and its subsidiaries reserve the right to make modifications, enhancements, improvements, corrections or other changes without further notice to this document and any product described herein. Diodes Incorporated does not assume any liability arising out of the application or use of this document or any product described herein; neither does Diodes Incorporated convey any license under its patent or trademark rights, nor the rights of others. Any Customer or user of this document or products described herein in such applications shall assume all risks of such use and will agree to hold Diodes Incorporated and all the companies whose products are represented on Diodes Incorporated website, harmless against all damages.

Diodes Incorporated does not warrant or accept any liability whatsoever in respect of any products purchased through unauthorized sales channel.

Should Customers purchase or use Diodes Incorporated products for any unintended or unauthorized application, Customers shall indemnify and hold Diodes Incorporated and its representatives harmless against all claims, damages, expenses, and attorney fees arising out of, directly or indirectly, any claim of personal injury or death associated with such unintended or unauthorized application.

Products described herein may be covered by one or more United States, international or foreign patents pending. Product names and markings noted herein may also be covered by one or more United States, international or foreign trademarks.

**LIFE SUPPORT**

Diodes Incorporated products are specifically not authorized for use as critical components in life support devices or systems without the express written approval of the Chief Executive Officer of Diodes Incorporated. As used herein:

A. Life support devices or systems are devices or systems which:

1. are intended to implant into the body, or
2. support or sustain life and whose failure to perform when properly used in accordance with instructions for use provided in the labeling can be reasonably expected to result in significant injury to the user.

B. A critical component is any component in a life support device or system whose failure to perform can be reasonably expected to cause the failure of the life support device or to affect its safety or effectiveness.

Customers represent that they have all necessary expertise in the safety and regulatory ramifications of their life support devices or systems, and acknowledge and agree that they are solely responsible for all legal, regulatory and safety-related requirements concerning their products and any use of Diodes Incorporated products in such safety-critical, life support devices or systems, notwithstanding any devices- or systems-related information or support that may be provided by Diodes Incorporated. Further, Customers must fully indemnify Diodes Incorporated and its representatives against any damages arising out of the use of Diodes Incorporated products in such safety-critical, life support devices or systems.

Copyright © 2010, Diodes Incorporated

[www.diodes.com](http://www.diodes.com)