



Principales

Gamme de produits	Harmony XB5
Fonction produit	Tête de bouton-tournant à clé
Nom abrégé de l'appareil	ZB5
Matériau de la collerette	Plastique
Diamètre de fixation	22 mm
Vente par quantité indivisible	1
Forme de la tête de l'unité de signalisation	Rond
Type d'unité de commande	Position maintenue
Profil de l'unité de commande	Noir bouton-tournant à clé
Positions de l'unité de commande	2 position 90°
Type de serrure à clé	Ronis 421E
Position de retrait de la clé	Dans toutes les positions

Complémentaires

Largeur hors tout CAO	29 mm
Hauteur hors tout CAO	29 mm
Profondeur hors tout CAO	72 mm
Poids	0.057 kg
Durée de vie mécanique	1000000 cycle
Boite associée	XALD 1...5 trous XALK 2...5 trous
Electrical composition code	C11 pour <= 3 contacts using unique blocs en montage avant C15 pour 1 contacts using unique blocs en montage avant SF1 pour <= 3 contacts using unique blocs en montage avant SR1 pour <= 3 contacts using unique blocs en montage arrière C3 pour <= 6 contacts using unique blocs en montage avant C4 pour <= 6 contacts using simple et double blocs en montage avant C7 pour <= 4 contacts using unique blocs en montage avant C8 pour <= 4 contacts using simple et double blocs en montage avant C5 pour <= 5 contacts using unique blocs en montage avant C6 pour <= 5 contacts using simple et double blocs en montage avant

Environnement

traitement de protection	TH
température ambiante pour le stockage	-40...70 °C
température de fonctionnement	-40...70 °C
catégorie de surtension	Classe II conformément à IEC 60536
degré de protection IP	IP67 IP66 conformément à IEC 60529 IP69K IP69
tenue à l'environnement NEMA	NEMA 13 NEMA 4X
tenue au nettoyage haute pression	7000000 Pa à 55 °C, distance: 0,1 m
Tenue aux chocs IK	IK06 conformément à IEC 50102
normes	EN/IEC 60947-1 EN/IEC 60947-5-1 EN/IEC 60947-5-4 JIS C 4520 UL 508 CSA C22.2 No 14

Le présent document comprend des descriptions générales et/ou des caractéristiques techniques générales sur la performance des produits auxquels il se réfère. Le présent document ne peut être utilisé pour déterminer l'aptitude ou la fiabilité de ces produits pour des applications utilisateur spécifiques et n'est pas destiné à se substituer à cette détermination. Il appartient à chaque utilisateur ou intégrateur de réaliser, sous sa propre responsabilité, l'analyse de risques complète et appropriée, d'évaluer et tester les produits dans le contexte de leur application ou utilisation spécifique. Ni la société Schneider Electric Industries SAS, ni aucune de ses filiales ou sociétés dans lesquelles elle détient une participation, ne peut être tenue pour responsable de la mauvaise utilisation de l'information contenue dans le présent document.

certifications du produit

BV
 CSA
 DNV
 GL
 LROS (Lloyds register of shipping)
 RINA
 Listé UL

tenue aux vibrations	5 gn (f = 2...500 Hz) conformément à IEC 60068-2-6
tenue aux chocs mécaniques	30 gn (durée = 18 ms) pour accélération sur 1/2 sinusoïde conformément à IEC 60068-2-27 50 gn (durée = 11 ms) pour accélération sur 1/2 sinusoïde conformément à IEC 60068-2-27

Contractual warranty

Période	18 mois
---------	---------

Dimensions

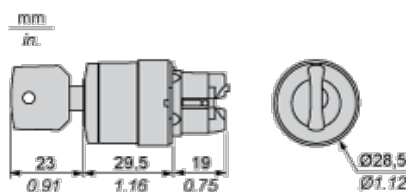

Panel Cut-out for Pushbuttons, Switches and Pilot Lights (Finished Holes, Ready for Installation)

Connection by Screw Clamp Terminals or Plug-in Connectors or on Printed Circuit Board

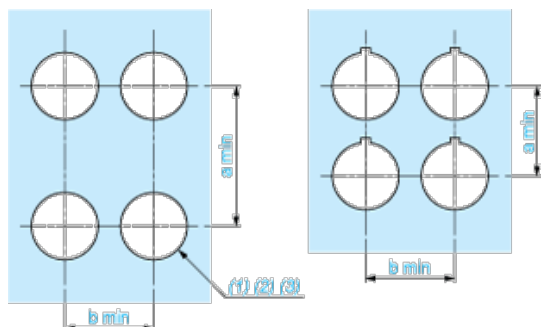

- (1) Diameter on finished panel or support
- (2) For selector switches and Emergency stop buttons, use of an anti-rotation plate type ZB5AZ902 is recommended.
- (3) Ø22.5 mm recommended (Ø22.3₀^{+0.4}) / Ø0.89 in. recommended (Ø0.88 in. ₀^{+0.016})

Connections	a in mm	a in in.	b in mm	b in in.
By screw clamp terminals or plug-in connector	40	1.57	30	1.18
By Faston connectors	45	1.77	32	1.26
On printed circuit board	30	1.18	30	1.18

Detail of Lug Recess

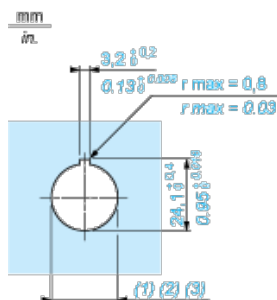

- (1) Diameter on finished panel or support

- (2) For selector switches and Emergency stop buttons, use of an anti-rotation plate type ZB5AZ902 is recommended.
- (3) $\varnothing 22.5$ mm recommended ($\varnothing 22.3_{-0}^{+0.4}$) / $\varnothing 0.89$ in. recommended ($\varnothing 0.88$ in. $_{-0}^{+0.016}$)

Pushbuttons, Switches and Pilot Lights for Printed Circuit Board Connection

Panel Cut-outs (Viewed from Installer's Side)

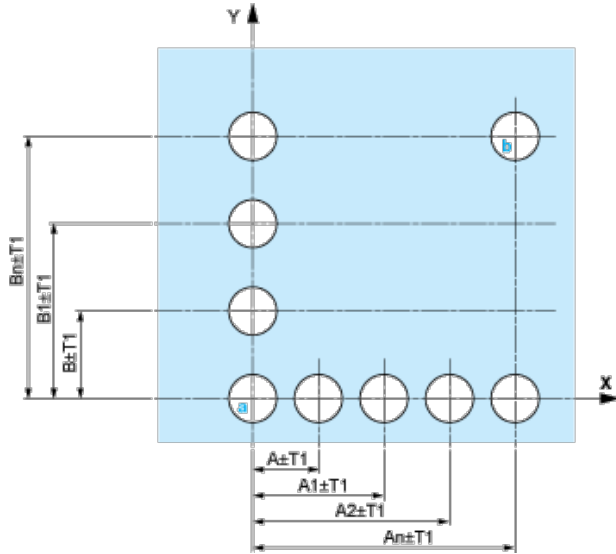

- A: 30 mm min. / 1.18 in. min.
- B: 40 mm min. / 1.57 in. min.

Printed Circuit Board Cut-outs (Viewed from Electrical Block Side)

Dimensions in mm

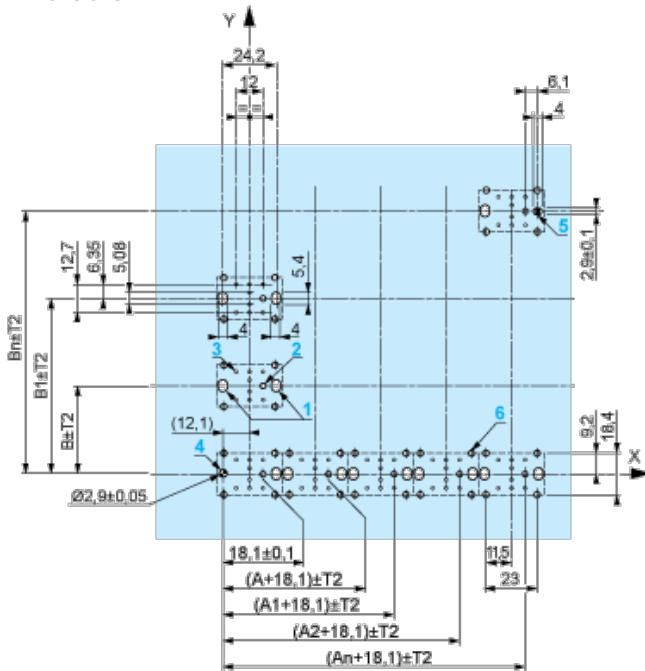

- A: 30 mm min.
- B: 40 mm min.

Dimensions in in.



A: 1.18 in. min.

B: 1.57 in. min.

General Tolerances of the Panel and Printed Circuit Board

The cumulative tolerance must not exceed 0.3 mm / 0.012 in.: $T1 + T2 = 0.3 \text{ mm max.}$

Installation Precautions

- | Minimum thickness of circuit board: 1.6 mm / 0.06 in.
- | Cut-out diameter: 22.4 mm \pm 0.1 / 0.88 in. \pm 0.004
- | Orientation of body/fixing collar ZB5AZ009: \pm 2°30' (excluding cut-outs marked **a** and **b**).
- | Tightening torque of screws ZBZ006: 0.6 N.m (5.3 lbf.in) max.
- | Allow for one ZB5AZ079 fixing collar/pillar and its fixing screws:
 - | every 90 mm / 3.54 in. horizontally (X), and 120 mm / 4.72 in. vertically (Y).
 - | with each selector switch head (ZB5AD•, ZB5AJ•, ZB5AG•).

The fixing centers marked **a** and **b** are diagonally opposed and must align with those marked 4 and 5.



- (1) Head ZB5AD•
- (2) Panel
- (2) Nut
- (4) Printed circuit board

Mounting of Adapter (Socket) ZBZ01•

- | 1 2 elongated holes for ZBZ006 screw access
- | 2 1 hole \varnothing 2.4 mm \pm 0.05 / 0.09 in. \pm 0.002 for centring adapter ZBZ01•
- | 3 8 \times \varnothing 1.2 mm / 0.05 in. holes
- | 4 1 hole \varnothing 2.9 mm \pm 0.05 / 0.11 in. \pm 0.002, for aligning the printed circuit board (with cut-out marked **a**)

- | 5 1 elongated hole for aligning the printed circuit board (with cut-out marked **b**)
- | 6 4 holes \varnothing 2.4 mm / 0.09 in. for clipping in adapter ZBZ01•

Dimensions An + 18.1 relate to the \varnothing 2.4 mm \pm 0.05 / 0.09 in. \pm 0.002 holes for centring adapter ZBZ01•.

Electrical Composition Corresponding to Code C4



Electrical Composition Corresponding to Code C5



Electrical Composition Corresponding to Code C6

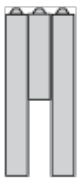

Electrical Composition Corresponding to Code C7

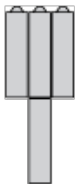

Electrical Composition Corresponding to Code C8



Electrical Composition Corresponding to Code C3



Electrical Composition Corresponding to Codes C9, C11, SF1 and SR1



Legend

Single contact



Double contact



Light block



Possible location



Sequence of Contacts Fitted to 2-position Selector Switch Body

Position 315°



Push	Position	Top			
		Bottom			
	Location		Left	Centre	Right
	State		0	0	0
Contacts	N/O	open	open	open	
	N/C	closed	closed	closed	

Position 45°



Push	Position	Top			
		Bottom			
	Location		Left	Centre	Right
	State		1	1	1
Contacts	N/O		closed	closed	closed
	N/C		open	open	open