

Technical Explanation
Data Sheet SKYPER®
Prime

Revision:	04
Issue date:	2015-10-14
Prepared by:	Hendrik Flohrer
Approved by:	Johannes Krapp

Keyword: IGBT Driver

1. Introduction.....	2
2. Driver interface	4
2.1 Controller interface – primary side pinning	4
3. Mechanical information	5
4. Protection features	6
4.1 Failure management.....	6
4.2 Error in/output.....	6
4.3 Dead time generation (Interlock TOP / BOT) adjustable	7
4.4 Short pulse suppression	8
4.5 Dynamic short circuit protection by V_{CEsat} monitoring (DSCP)	8
4.6 Soft Off.....	9
4.7 Under voltage protection primary and secondary.....	9
5. Sense signals.....	9
5.1 Temperature signal	9
5.2 DC Llink signal.....	10
6. Electrical characteristic.....	11
7. Environmental conditions	12
8. Marking.....	13

1. Introduction

The SKYPER Prime constitutes an interface between Semitrans 10 or Primepack modules and the controller. SKYPER Prime can drive IGBTs up to 1400 A and 1700V.

Benefits

- Cost saving with integrated & galvanically insulated temp + DC link signal
- Second source interface to available driver solutions
- Digital sensor signal output (PWM) allows direct μ C connection without adapterboards
- Qualified module driver bundle: Simple plug & play, no redesign loops on customer side
- For SEMITRANS 10 and Primepack modules
- Long service life with with ASIC integration (MTBF>3 Mio h)
- Safe gate control with SoftOff, UVP, Vce, regulated gate voltages
- Simple paralleling up to 3 modules with board to board connection

Figure 1: SKYPER® Prime

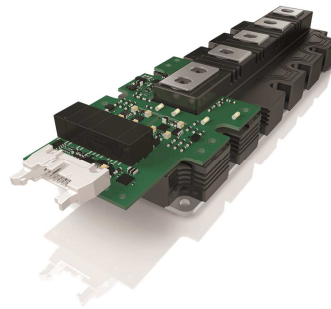

Features

- Two output channels
- Robust rectangle signal transmission
- Second source interface to available driver solutions
- Highest noise immunity with short pulse suppression and robust interface
- Insulated temp and DC link signal
- Under voltage protection (UVP) primary and secondary
- Dynamic Short Circuit Protection (DSCP) by VCE monitoring and direct SoftOff
- Integrated isolated power supply for the secondary side
- Up to 17 μ C gate charge
- **MTBF rate > 3 Million hours**

Figure 2: Block diagram of SKYPER® Prime

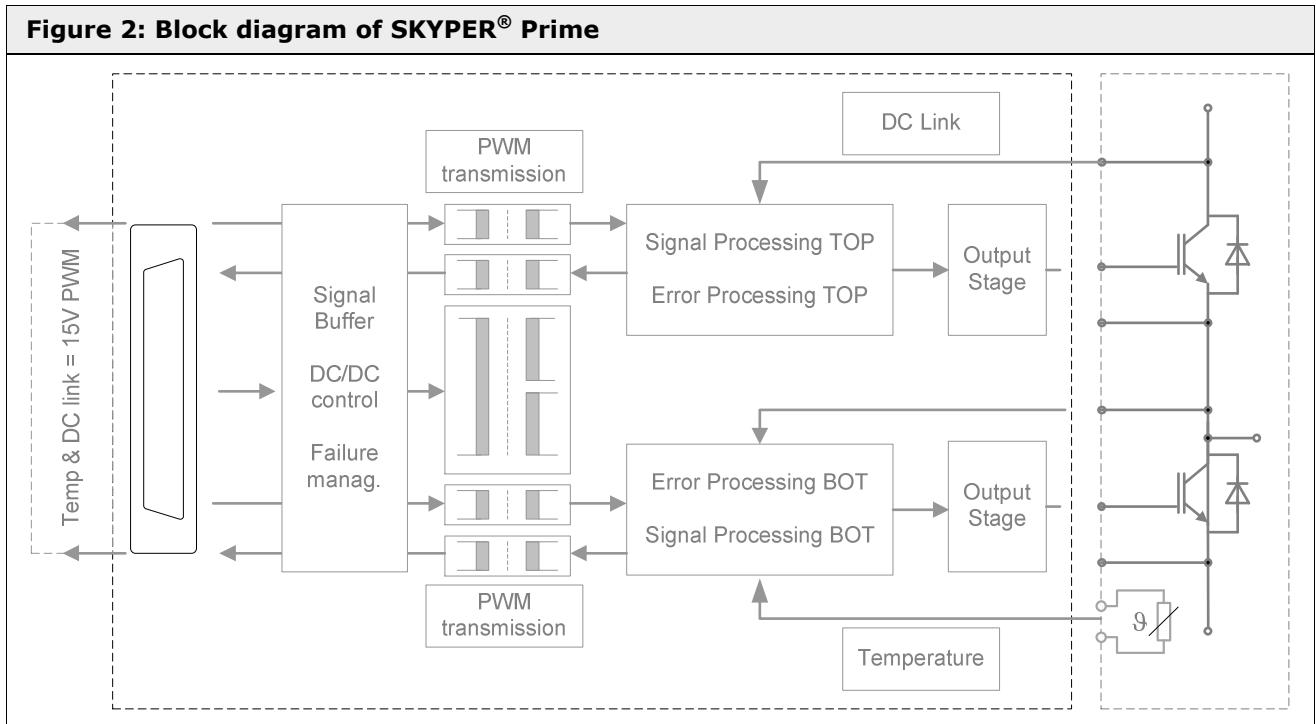

2. Driver interface

2.1 Controller interface – primary side pinning

Table 1: Controller Interface - Connector X1 (DIN41651 – 20P) – second source compatible			
PIN	Signal	Function	Specification
X1:01	IF_PWR_15P	Drive power supply	Stabilised +15V ±4%
X1:02	IF_DC_LINK	Digitised DC Link signal	PWM output, 15V
X1:03	IF_PWR_15P	Drive power supply	Stabilised +15V ±4%
X1:04	IF_GND	GND	To be connected to ground
X1:05	IF_PWR_15P	Drive power supply	Stabilised +15V ±4%
X1:06	IF_GND	GND	To be connected to ground
X1:07	IF_nERROR_IN	ERROR input	LOW (GND, U_{TH} 1V) = External error HIGH (VP, U_{TH} 14V) = No error Max input current 1,8mA, can be connected with IF_nERROR_OUT
X1:08	IF_GND	GND	To be connected to ground
X1:09	IF_nERROR_OUT	ERROR output	LOW = ERROR; open collector output; 15V / 10mA (external pull up resistor necessary), reset: 30µs inputs low
X1:10	IF_GND	GND	To be connected to ground
X1:11	IF_HB_TOP	Switching signal input (TOP switch)	Positive 15V CMOS logic, LOW = TOP switch off; HIGH = TOP switch on
X1:12	IF_GND	GND	To be connected to ground
X1:13	IF_nERROR_OUT	ERROR output	LOW = ERROR; open collector output; 15V / 10mA (external pull up resistor necessary), reset: 30µs inputs low
X1:14	IF_GND	GND	To be connected to ground
X1:15	IF_HB_BOT	Switching signal input (BOTTOM switch)	Positive 15V CMOS logic, LOW = BOT switch off; HIGH = BOT switch on
X1:16	IF_GND	GND	To be connected to ground
X1:17	IF_CFG_SELECT	Interlock set up	HIGH (VP) = No interlock LOW (GND) = Interlock 4µs
X1:18	IF_GND	GND	To be connected to ground
X1:19	IF_TEMP	Digitised NTC signal	PWM output, 15V
X1:20	IF_GND	GND	To be connected to ground

3. Mechanical information

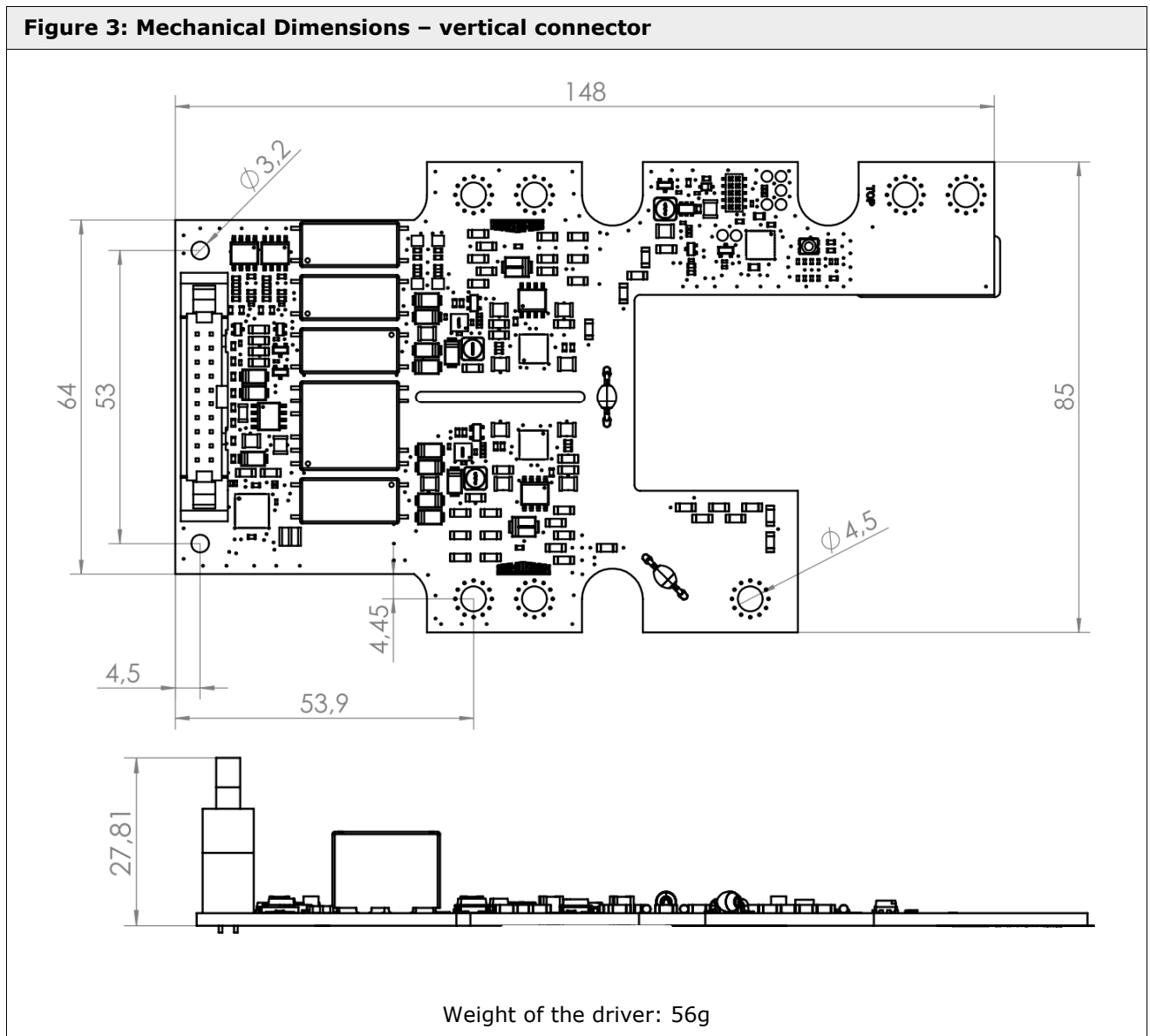

Details for assembly: Please refer to each IGBT module mounting instruction like "Mounting Instruction SEMITRANS® 10".

4. Protection features

4.1 Failure management

The SKYPER PRIME detects certain errors on the driver. Any error detected will force the output PRIM_nERROR_OUT into low state and has to be reset by the controller. The IGBTs will be switched off (IGBT driving signals set to LOW). The input side switching signals of the driver will be ignored. The input signals have to be set to low status for 9 μ s and the error must be solved for 30 μ s for reset. All error inputs can be paralleled and directly connected to other drivers' error inputs for fast error reaction.

The controller must react on the error signal X1:09/13 IF_nERROR_OUT. As long as the error signal indicates an error PWM switching pulses must be set to low by the controller. The error signal is active for minimum 30 μ s. After the error signal indicates no error condition anymore, the PWM signals can be applied further.

Following failures are indicated by the failure output

- Over DC link voltage
- Under supply voltage primary side
- Under supply voltage secondary side
- Short circuit with SoftOff

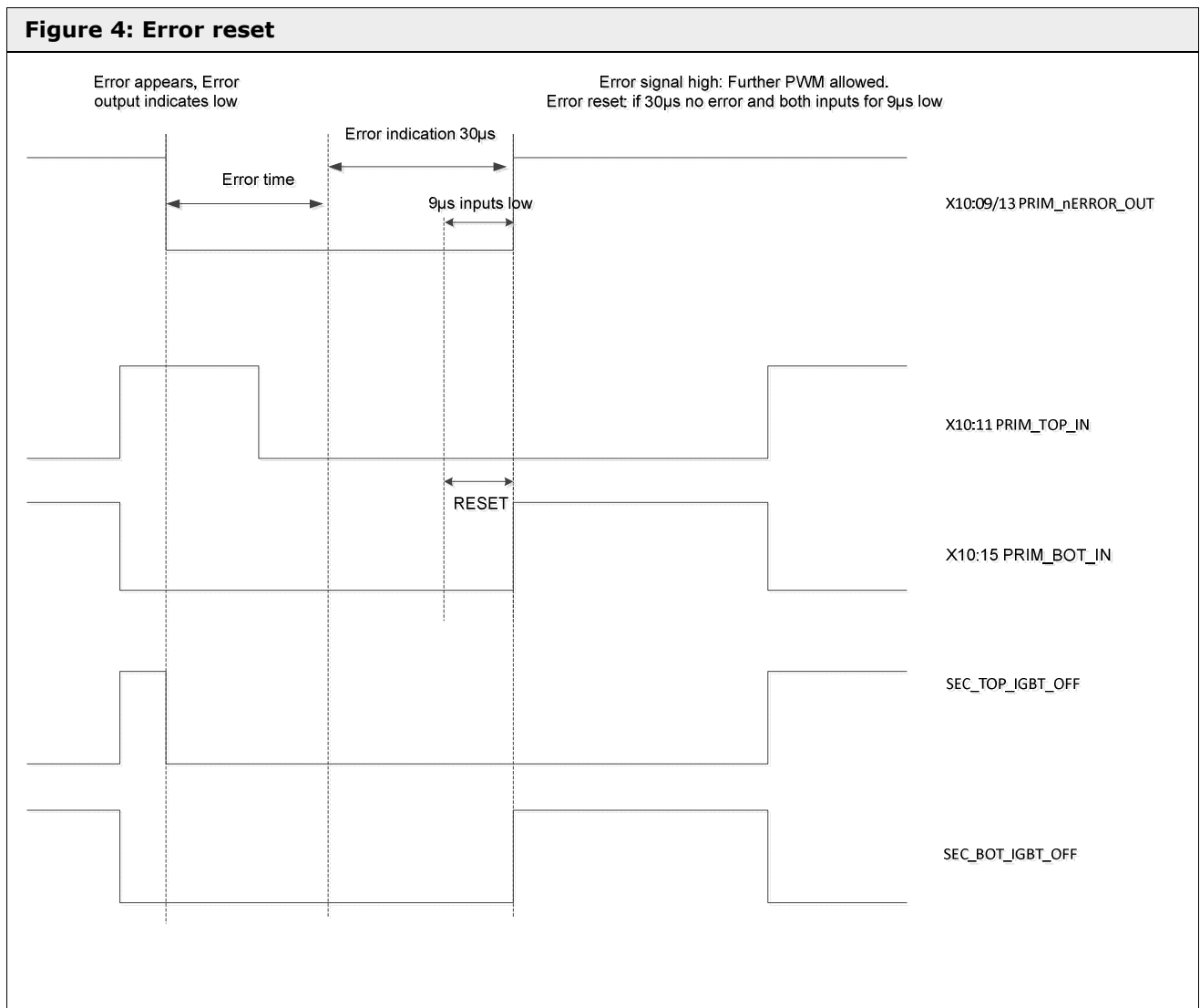

4.2 Error in/output

Table 2: Dead time generation			
PIN	Signal	Function	Specification
X1:07	IF_nERROR_IN	ERROR input	LOW (GND, U_{TH} 1V) = External error HIGH (VP, U_{TH} 14V) = No error Max input current 1,8mA, can be connected with IF_nERROR_OUT
X1:09	IF_nERROR_OUT	ERROR output	LOW = ERROR; open collector output; 15V / 10mA (external pull up resistor necessary), reset: 30 μ s inputs low
X1:13	IF_nERROR_OUT	ERROR output	LOW = ERROR; open collector output; 15V / 10mA (external pull up resistor necessary), reset: 30 μ s inputs low

The error output X1/09/13 is connected on driver side and send out a summarized error input. The connection of one output is enough for complete error indication.

Error input X1:07 and error output X1:09/13 can be connected also between different drivers. By that the error of one driver switches the other drivers directly off.

As soon as a low signal (=error) applied to X1:07 the driver indicates an error message for 30 μ s to X1:09/13. As long as further PWM is applied the error indication on X1:09/13 is active. If both PWM inputs are set to low, the error message disappears after 30 μ s to avoid locking of the driver in the case of connection of error in and output.

4.3 Dead time generation (Interlock TOP / BOT) adjustable

Table 3: Dead time generation			
PIN	Signal	Function	Specification
X1:17	IF_CFG_SELECT	Interlock set up	HIGH (VP) = No interlock LOW (GND) = Interlock 4 μ s

The internal dead time of SKYPER PRIME is set to 4 μ s. The DT circuit prevents, that TOP and BOT IGBT of one half bridge are switched on at the same time (shoot through). The dead time is realised in the mixed signal ASIC. The dead time is not added to a dead time given by the controller. The highest dead time dominates.

Table 4: Dead time generation			
	Controller dead time	SKYPER dead time	Total dead time
Controller > driver	5 μ s	4 μ s	5 μ s
Controller < driver	1 μ s	4 μ s	4 μ s
Controller no dead time	No dead time	4 μ s	4 μ s
Controller no dead time	No dead time	No dead time	No dead time

It is possible to control the driver with one switching signal and its inverted signal. No error signal will be generated when signals are overlapped.

4.4 Short pulse suppression

This driver circuit suppresses short turn-on and off-pulses of incoming signals. This way the IGBTs are protected against spurious noise as they can occur due to bursts on the signal lines. Short or high noise pulses don't affect the driver on the controller side. The digital SPS is set to 390ns. For different filter times please contact your local sales contact.

4.5 Dynamic short circuit protection by V_{CEsat} monitoring (DSCP)

The DSCP monitors the collector-emitter voltage V_{CE} of the IGBT during its on-state. Immediately after turn-on of the IGBT, a higher value is effective than in steady state.

Figure 5: Reference Voltage (V_{CEref}) Characteristic

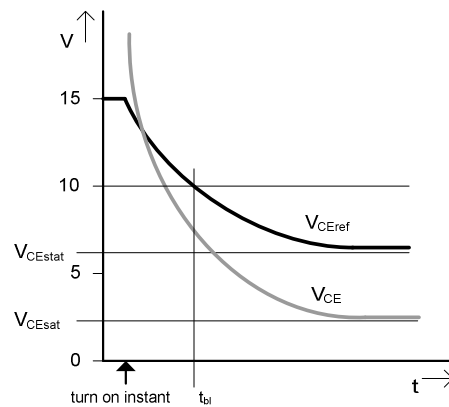

After t_{bi} has passed, the V_{CE} monitoring will be triggered as soon as $V_{CE} > V_{CEref}$ and will turn off the IGBT. The Vce monitoring settings is optimized to each module type and must not be adjusted by the user. The short circuit monitoring is set according to each module type separately. No further modification is necessary. Blanking time and threshold voltage is written in the datasheet.

4.6 Soft Off

In the event of short circuit, the driver switches off with a separate output stage which slows down the turn-off speed of the IGBT. The over voltage will be reduced significantly and the IGBTs will be switched off safely. The softoff setup is done according to each module and must not be changed.

4.7 Under voltage protection primary and secondary

The driver monitors the supply voltages on primary and secondary side. Threshold voltages are indicated in the data sheet.

5. Sense signals

The driver offers galvanically insulated temperature and DC link signals to the interface connector saving external power supplies and insulation boards.

5.1 Temperature signal

The temperature signal of the module integrated NTC KG3B-35-5-S6Z sensor is insulated and available as digital PWM signal to the customer's controller. The NTC signal is converted in the form of a pulse pattern (PWM information) corresponding to the analogue value. That information can be directly read out by the customer's controller – capture-compare unit.

Table 5: Temperature signal				
Parameters	Min	Typ	Max	Unit
ADC		12		bit
Bandwidth		1		kHz
Accuracy at 85°C		5		%
Measurement range	25		135	°C
PWM output		10		kHz
Ratio	1% =25°C		99% =135°C	

Please consider that there is a deviation between the chip temperature and the NTC value.

5.2 DC Llink signal

The DC link signal is galvanically insulated and available as PWM signal to the customer.

Table 6: DC Llink signal				
Parameters	Min	Typ	Max	Unit
ADC		12		bit
Bandwidth		1		kHz
Accuracy at 1300V, -40°C to 85°C		1,7		%
Trip level		1250		V
Measurement range	0		1300	V
PWM output		10		kHz
Ratio	1% =0V		99% =1300V	
Reaction time with switch off		75		µs
Response time (90% U _{in})	100		175	µs

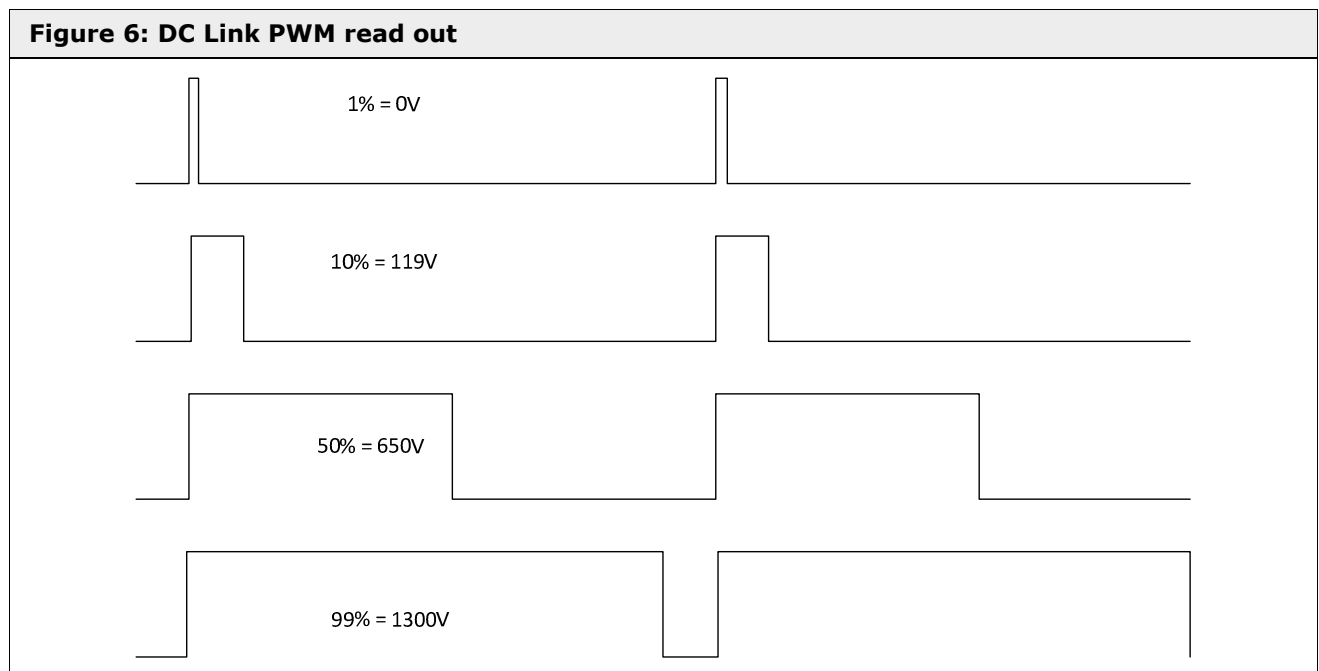
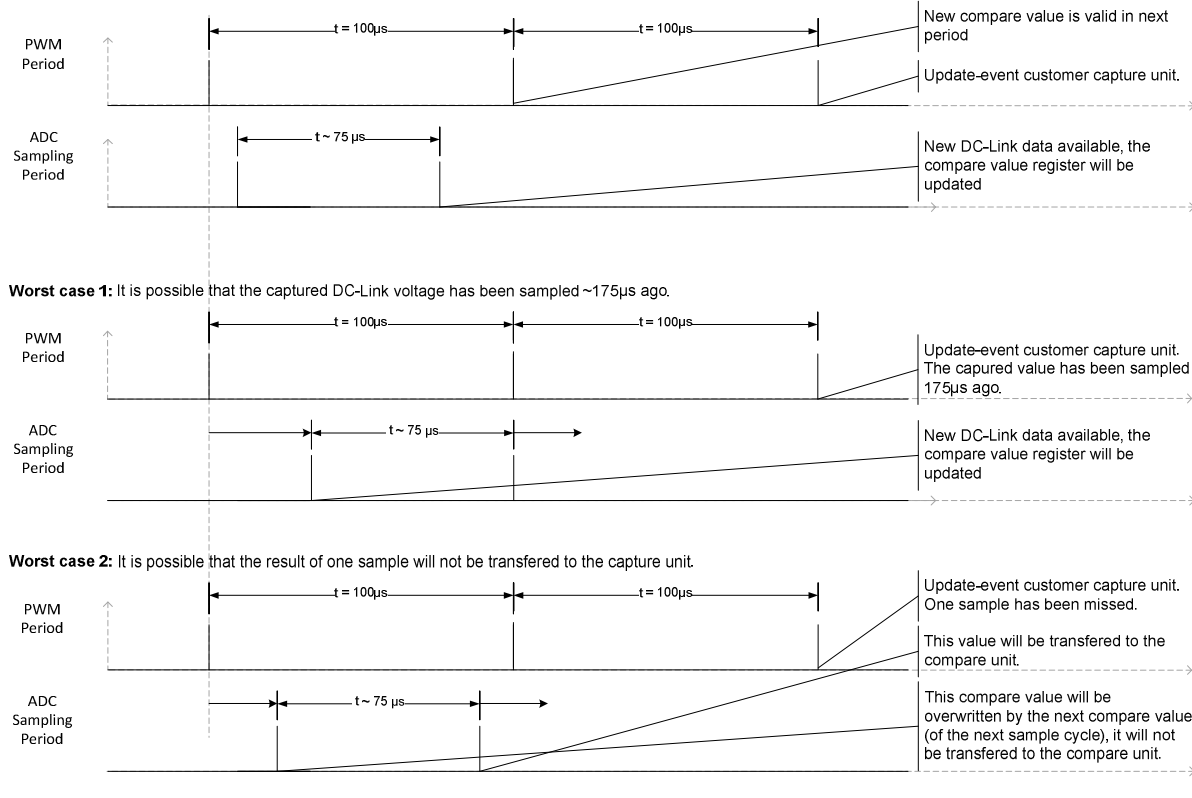

Figure 7: Signal characteristic samples

Example for capture of DC-Link voltage (unsynchronized output)

The PWM-Period is 100µs, the Sampling-Period is ~75µs (not synchronized)



6. Electrical characteristic

Figure 8: Maximum switching frequency @ different gate charges @ Tamb=25°C

$$f_{\max} = \frac{I_{out\ AV\ max}}{Q_{GE}}$$

f_{\max} : Maximum switching frequency
 $I_{out\ AV\ max}$: Maximum output average current
 Q_{GE} : Gate charge of the driven IGBT

The maximum switching frequency is related to each module type and is indicated in the data sheet.

7. Environmental conditions

Table 7: Conditions		
Insulation parameters		Rating
Climatic Classification Pollution Degree (PD)		PD2
Climate class		3K3 – IEC60721
Maximum altitude (above sea level)		2000 meter above sea
Overvoltage category (according to EN50178)		OVC 3
Isolation resistance test, Prim-Sec, not performed as series test. Insulation test must be performed in the system.		5000 V _{AC} , rms, 2s
Rated insulation voltage (EN60664-1)		8 kV Cat. III
Environmental Condition	Norm / Standard	
Operating/storage temperature	-40.. +85 °C	
High humidity	85 °C, 85%	
Flammability	UL94 V0	Heavy flammable materials only
	RoHS / WEEE / China RoHS	
EMC Condition	Norm / Standard	Parameter
ESD	IEC 61000-4-2 IEC 61800-3	6 kV contact discharge / 8 kV air discharge
Burst	IEC 61000-4-4 IEC 61800-3	≥ 2kV on adaptor board for signal lines ≥ 4kV for AC lines
Immunity against radiated interference	IEC 61000-4-3 IEC 61800-3	≥ 20V/m 80MHz – 1000 MHz
Immunity against conducted interference	IEC 61000-4-6 IEC 61800-3	≥ 20V 150kHz – 80MHz
Shock Vibration		
Vibration	Sinusoidal 20Hz ... 500Hz, 5g, 2h per axis (x, y, z), 26 sweeps Random 10Hz ... 2000Hz, 3g, 2 h per axis (x, y, z)	
Shock	180 Shocks (6 axis; +-x, +-y, +-z, 30 shocks per axis), 30g, 11ms Connection between driver and PCB has to be reinforced by support post	

8. Marking

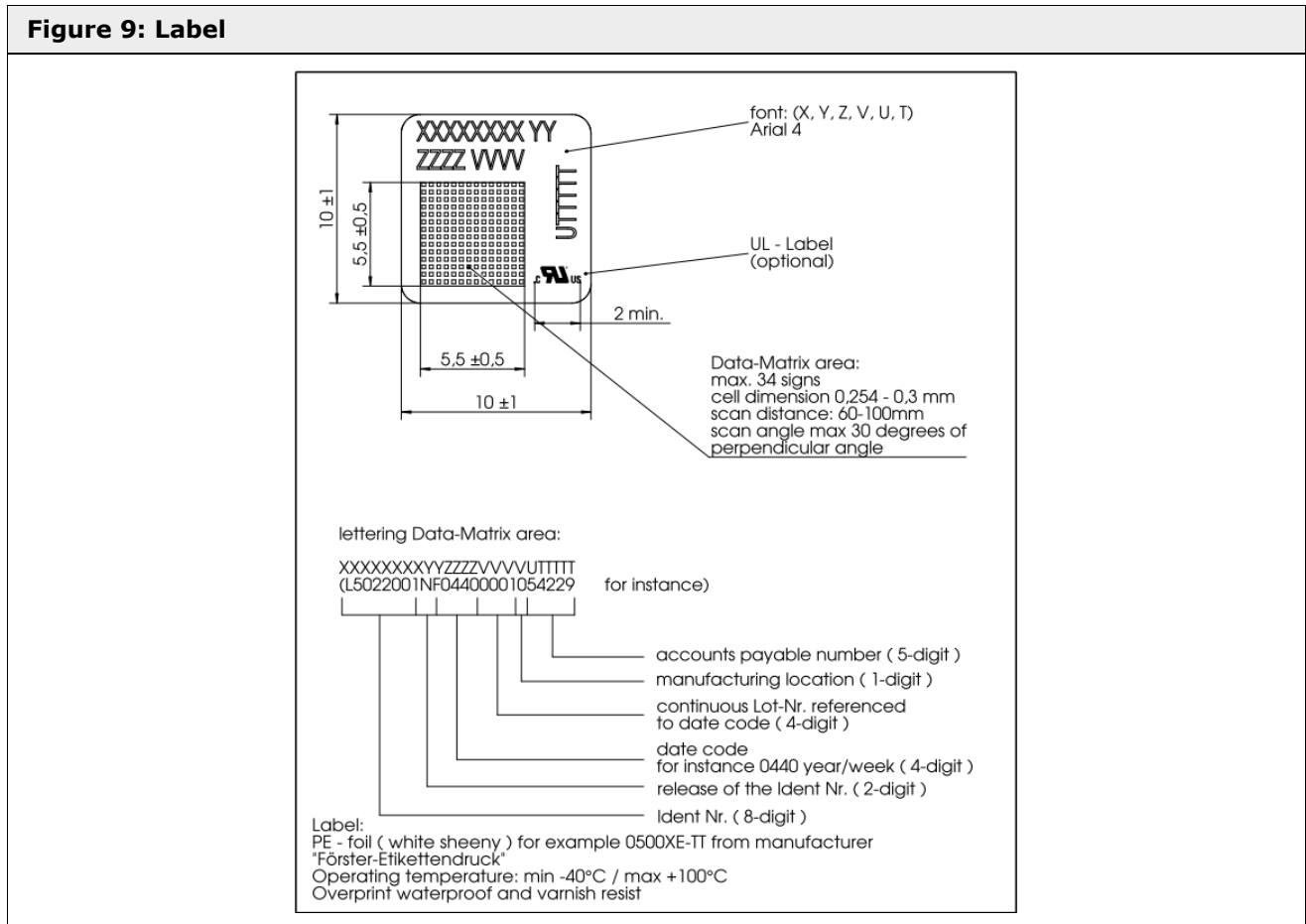

Every driver core is marked with a data matrix label. The marking contains the following items.

Figure 1: SKYPER® Prime.....	2
Figure 2: Block diagram of SKYPER® Prime	3
Figure 3: Mechanical Dimensions	5
Figure 4: Error reset	6
Figure 5: Reference Voltage ((VCEref) Characteristic.....	8
Figure 6: DC Link PWM read out	10
Figure 7: Signal characteristic samples.....	11
Figure 8: Maximum switching frequency @ different gate charges @ Tamb=25°C.....	11
Figure 9: Label	13
Table 1: Controller Interface - Connector X1 (DIN41651 – 20P) – second source compatible.....	4
Table 2: Dead time generation	7
Table 3: Dead time generation	7
Table 4: Dead time generation	7
Table 5: Temperature signal	9
Table 6: DC Llink signal	10
Table 7: Conditions	12

References

- [1] www.SEMIKRON.com
- [2] A. Wintrich, U. Nicolai, W. Tursky, T. Reimann, "Application Manual Power Semiconductors", ISLE Verlag 2011, ISBN 978-3-938843-666

HISTORY

SEMIKRON reserves the right to make changes without further notice herein

DISCLAIMER

SEMIKRON reserves the right to make changes without further notice herein to improve reliability, function or design. Information furnished in this document is believed to be accurate and reliable. However, no representation or warranty is given and no liability is assumed with respect to the accuracy or use of such information, including without limitation, warranties of non-infringement of intellectual property rights of any third party. SEMIKRON does not assume any liability arising out of the application or use of any product or circuit described herein. Furthermore, this technical information may not be considered as an assurance of component characteristics. No warranty or guarantee expressed or implied is made regarding delivery, performance or suitability. This document supersedes and replaces all information previously supplied and may be superseded by updates without further notice.

SEMIKRON products are not authorized for use in life support appliances and systems without the express written approval by SEMIKRON.

SEMIKRON INTERNATIONAL GmbH
P.O. Box 820251 • 90253 Nuremberg • Germany
Tel: +49 911-65 59-234 • Fax: +49 911-65 59-262

sales.skd@semikron.com • www.semikron.com