

DB123399
CEBEC 12
DB116619
VDE
iTL, iTLI,
iTLs, iTLc,
iTLm
Country approval pictograms

IEC/EN 60669-2-2
iTLs: IEC/EN 60947-5-1

Impulse relays



iTL

- The impulse relays are used to control, by means of pushbuttons, lighting circuits consisting of:
 - incandescent lamps, low-voltage halogen lamps, etc. (resistive loads)
 - fluorescent lamps, discharge lamps, etc. (inductive loads)

Remote indication



iTLs

- Allows remote indication of its operating state (open/closed)



Indication iATLs

- Allows remote indication of the associated impulse relay

Centralised control



iTLc

- Allows centralised control of a group of TLC impulse relays, whilst at the same time retaining local impulse-type control



Centralised control iATLc

- Used for centralised control, thanks to a "pilot line", of a group of impulse relays controlling separate circuit, while at the same time maintaining local individual control of each impulse relay

Latched control



iTLm

- Operated by latched orders from a changeover contact (switch, time switch, thermostat). Manual control does not work



Latched control iATLm

- Controls the associated impulse relay by latched orders from a changeover contact

Impulse relays are used:

- Closing of the impulse relay pole(s) is triggered by an impulse on the coil.
- Having two stable mechanical positions, the pole(s) will be opened by the next impulse. Each impulse received by the coil reverses the position of the pole(s).
- Can be controlled by an unlimited number of pushbuttons.
- Zero energy consumption.

PB106131-34



Changeover contact iTLi

- This impulse relay has a changeover contact

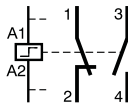

PB106134-34



Extensions iETL

- Used to increase the number of impulse relay poles
- Can be installed on the iTL, iTLi, iTLc, iTLm and iTLs

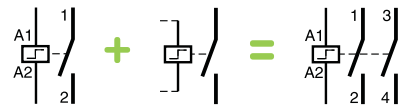

PB106140-34



Centralised control + indication iATLc+s

- Used for centralised control, thanks to a "pilot line", of a group of impulse relays controlling separate circuit, while at the same time maintaining local individual control of each impulse relay
- Remote indication of the mechanical status of each relay

PB106136-34



Multi-level centralised control iATLc+c

- Allows centralised control of a group of iTLc or "iTL + ATLc" impulse relays

PB107752-34



ComReady

Control and indication 24 V DC iATL24

- Allows control and indication of a 230 V AC impulse relay from the Acti 9 Smartlink or by a PLC, by 24 V DC signals
- Also allows control by a pulsed signal

PB106125-34



Time delay iATEt

- Combined with an impulse relay, it automatically disconnects the circuit after a preset time

PB106141-34



Control iATLz

- Must be used when installing several illuminated PBs in parallel to control an impulse relay (prevents operating malfunctions)

PB106142-63



Step by step control iATL4

- Allows step-by-step control of two circuits via a single pushbutton

Mounting accessories

11	Yellow clips	A9C15415
12	9 mm spacer	A9A27062
13	Clip-on terminal markers	see module CA907001

DB126831

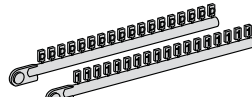

13



12



11

Auxiliaries

Centralised control			
2	iATLc ^{(1), (3)}	24...240 V AC	A9C15404
Indication			
3	iATLs ⁽¹⁾	24...240 V AC	A9C15405
Centralised control + indication			
4	iATLc+s ⁽³⁾	24...240 V AC	A9C15409
Multi-level centralised control			
5	iATLc+c ^{(2), (3)}	24...240 V AC	A9C15410
Step by step control			
6	iATL4	230 V AC	A9C15412
Control by illuminated push-buttons			
7	iATLz	130...240 V AC	A9C15413
Latched control			
8	iATLm ⁽¹⁾	12...240 V AC	A9C15414
Time delay control			
9	iATeT ⁽⁴⁾	24...240 V AC	A9C15419
Control and indication			
10	iATL24	230 V AC	A9C15424

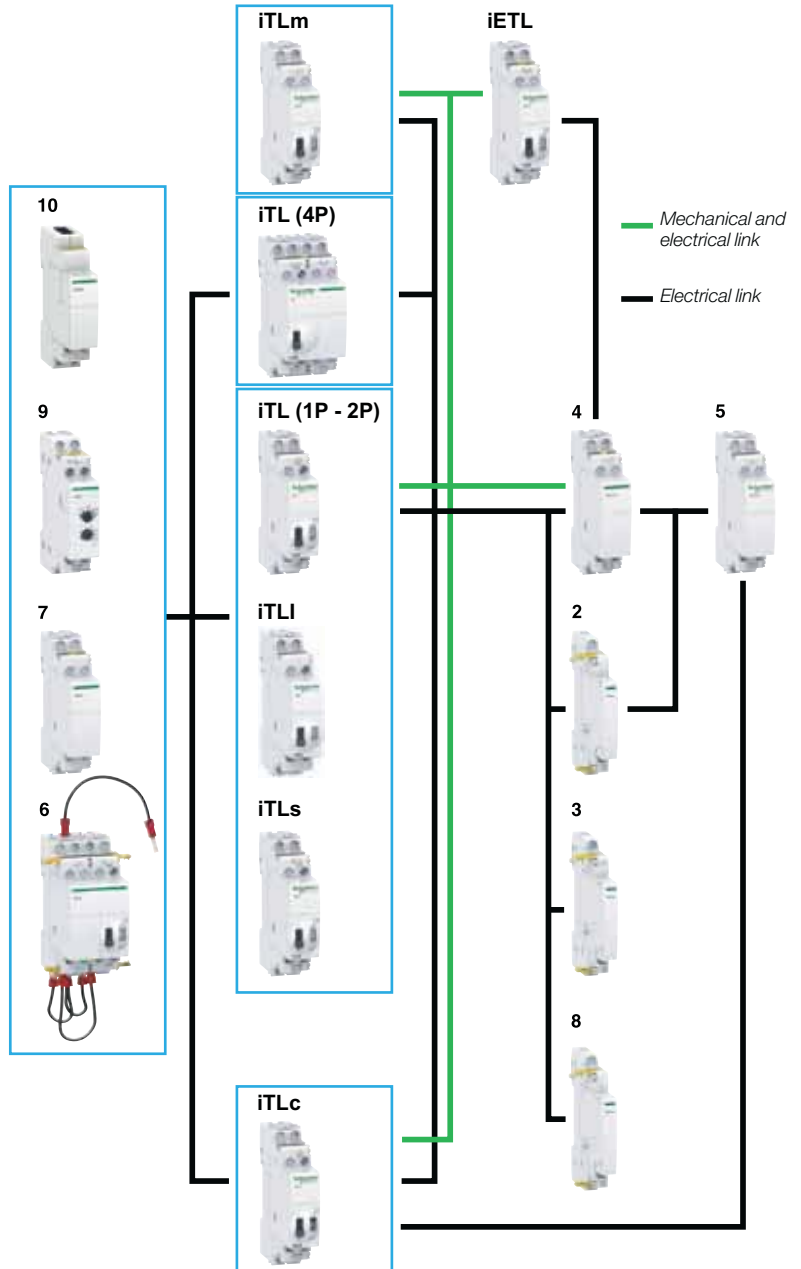

(1) The iATLc, iATLs and iATLm 9 mm auxiliaries are used by themselves to the right of an impulse relay.

(2) Connection by traditional cabling. The iATLc+c must be mounted to the right of an iATLc+s or an iATLc.

(3) The centralised control functions (iTLc, iATLc, iATLc+s, iATLc+c) only operate on AC voltage networks.

(4) iATeT: control voltage: 24...240 V AC, 24...110 V DC.

PB108128-41

Yellow clip
 ■ A simple clip-on system for flexible auxiliaries combination and improved robustness
 ■ For electrical and mechanical connections

■ Insulated terminals IP20

■ Large circuit labeling area

■ Built-in or optional auxiliary function: state indication, centralised control, latched control, control for illuminated pushbutton, step-by-step control, time delay

■ Consistent with the entire Acti 9 offer and with all types of lighting

■ Disconnection of remote control by selector switch (except for 4P single-piece iTL) for maintenance operation

■ Manual controls on front face: direct and priority manual control by O-I toggle
 ■ Mechanical contact position indicator

		Choice impulse relays auxiliaries																				
Type		Standard iTL					Changeover iTLI					iTLc centralised control			iTLm control on latched order		iTLs remote indication					
Rating	A	16				32	16					16				16			16			
Control voltage	V AC	230/240	130	48	24	12	230/240	230/240	130	48	24	12	230/240	48	24	230/240			230/240	48	24	
	V DC	110	48	24	12	6	110	110	48	24	12	6	-			-			110	24	12	
Auxiliaries																						
Extension																						
iETL		■	■	■	■	■	■	■	■	■	■	■	■	■	■			■	■	■		
Centralised control + indication																						
iATLc+s		■	■	■	■	-	■	■	■	■	-	-	-	-	-			■	■	■		
Centralised control																						
iATLc		■	■	■	■	-	■	■	■	■	-	-	-	-	-			■	■	■		
Indication																						
iATLs		■	■	■	■	-	■	■	■	■	■	■	■	■	■			■	■	■		
Multi-level centralised control																						
iATLc+c		■	■	■	■	-	■	■	■	■	-	■	■	■	-			■	■	■		
Latched control																						
iATLm		■	■	■	■	■	■	■	■	■	■	-	-	-	-			■	■	■		
Control for illuminated Pushbutton																						
iATLz		■	■	-	-	-	■	■	■	-	-	■	■	-	-			■	■	-		
Step by step control																						
iATL4		■	-	-	-	-	■	■	-	-	-	■	-	-	-			■	-	-		
Time delay control																						
iATEt		■	■	■	(*)	■	■	■	■	■	(*)	-	■	■	■	-			■	■	■	(*)
Control and indication																						
iATL24		■	-	-	-	-	■	■	-	-	-	■	-	-	-			■	-	-		

(*) iATEt : does not operate on 12 V DC.

Catalogue numbers

iTL impulse relays			1P	2P	3P	4P
Type						
Rating (In)	Control voltage (Uc)					
	(V AC)	(V DC)				
	(50/60 Hz)					
16 A	12	6	A9C30011	A9C30012	A9C30011 + A9C32016	A9C30012 + A9C32016
	24	12	A9C30111	A9C30112	A9C30111 + A9C32116	A9C30114
	48	24	A9C30211	A9C30212	A9C30211 + A9C32216	A9C30212 + A9C32216
	130	48	A9C30311	A9C30312	A9C30311 + A9C32316	A9C30312 + A9C32316
	230...240	110	A9C30811	A9C30812	A9C30811 + A9C32816	A9C30814
32 A	230...240	110	A9C30831	A9C30831 + A9C32836	A9C30831 + 2 x A9C32836	A9C30831 + 3 x A9C32836
Width in 9 mm modules			2	2	4	4

iTLI impulse relays			2P
Type			
Rating (In)	Control voltage (Uc)		
	(V AC)	(V DC)	
	(50/60 Hz)		
16 A	12	6	A9C30015
	24	12	A9C30115
	48	24	A9C30215
	130	48	A9C30315
	230...240	110	A9C30815
Width in 9 mm modules			2

iETL extensions for iTL and iTLI						
Type	Rating (In)			Control voltage (Uc)		Width in 9 mm modules
		(V AC)	(V DC)	(V AC)	(V DC)	
	(50/60 Hz)					
	1 NO	32 A	230...240	110	A9C32836	2
	1 NO/NC + 1 NO	16 A	12	6	A9C32016	2
			24	12	A9C32116	2
			48	24	A9C32216	2
			130	48	A9C32316	2
			230...240	110	A9C32816	2

iTLc , iTLm, iTLs with built-in auxiliary function

Catalogue numbers (cont.)

iTLc impulse relay with centralised control			
Type	1P		3P
	1NO		3P
Rating (In)	Control voltage (Uc) (V AC) (50/60 Hz)		
16 A	24		A9C33111
	48		A9C33211
	230...240		A9C33811
Width in 9 mm modules			2





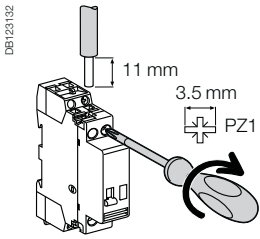

iTLm impulse relay with latched control			
Type	1P		3P
	1NO		3P
Rating (In)	Control voltage (Uc) (V AC) (50/60 Hz)		
16 A	230...240		A9C34811
Width in 9 mm modules			2

iTLs impulse relay with remote indication*			
Type	1P		3P
	1NO		3P
Rating (In)	Control voltage (Uc) (V AC) (50/60 Hz) (V DC)		
16 A	24 12		A9C32111
	48 24		A9C32211
	230...240 110		A9C32811
Width in 9 mm modules			2



(*) Short circuit protection device for indication contacts : 6 A gG fuse.

Connection



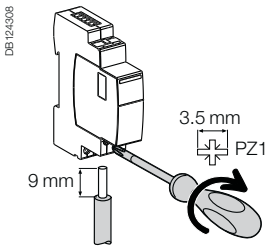

Type	Rating	Circuit	Tightening torque	Copper cables	
				Rigid or ferrule	Flexible or ferrule
iTL, iTLi, iTLc, iTLm, iTLs, iETL	16 A	Control	1 N.m		
		Power			
iTL, iETL	32 A	Control	1.2 N.m		
		Power			
iATLs, iATLc, iATLc+s, iATLc+c, iATLm, iATEt, iATL4, iATLz			1 N.m		

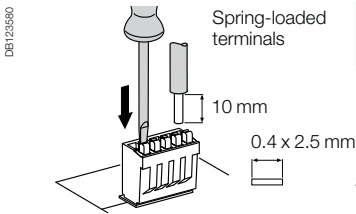

Type	Terminals	Tightening torque	Copper cables		
			Rigid	Flexible	Flexible or ferrule
iATL24	Power supply (N/P) Input (Y1/Y2)	1 N.m	 0.5 to 10 mm ² 2 x 0.5 to 2 x 2.5 mm ²	 0.5 to 6 mm ² 2 x 0.5 to 2 x 2.5 mm ²	 0.5 to 4 mm ² 2 x 0.5 to 2 x 2.5 mm ²

Ti24 connector connection



Type	Catalogue numbers	Copper cables	
		Rigid	Flexible
Ti24 interface	A9XC2412	 1 x 0.5 to 1.5 mm ²	 1 x 0.5 to 1.5 mm ²

Ti24 prefabricated cables connection

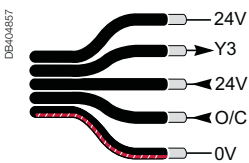

Type	Catalogue numbers	Length
Connection for Acti 9 Smartlink		
6 short prefabricated	A9XCAS06	100 mm
6 medium-sized prefabricated	A9XCAM06	160 mm
6 long prefabricated	A9XCAL06	870 mm
Connection for PLC type terminals		
6 long prefabricated on a single side	A9XCAU06	870 mm

Operation

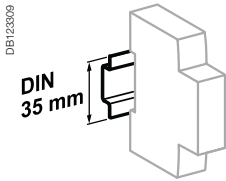
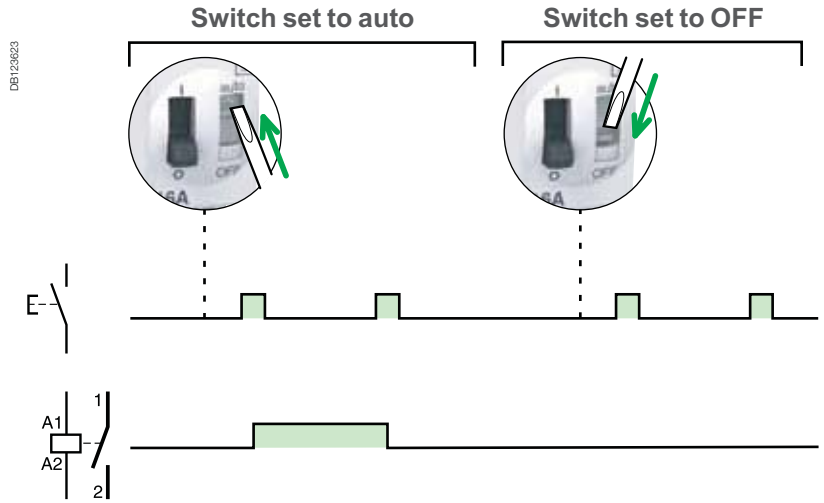

Clip on DIN rail 35 mm.

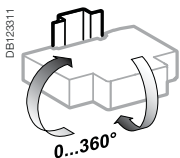

Indifferent position of installation.

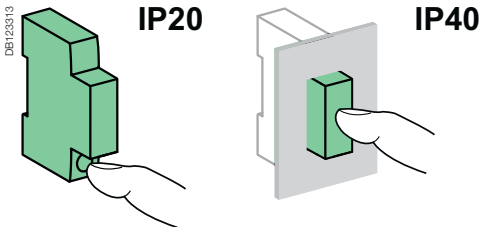





Technical data

Control circuit		
	iTL and iTLI 16 A iTLc, iTLm, iTLs, iETL 16 A	iTL 32 A, iETL 32 A
Dissipated power (during the impulse)	1, 2, 3P: 19 VA 4P: 38 VA	19 VA
Illuminated PB control	Max. current 3 mA (if > use an ATLz)	
Operating threshold	Min. 85 % of Un in conformance with IEC/EN60669-2-2	
Duration of the control order	50 ms to 1 s (200 ms recommended)	
Response time	50 ms	
Power circuit		
Voltage rating (Ue)	1P, 2P	24 ...250 V AC
	3P, 4P	24...415 V AC
Frequency	50 Hz or 60 Hz	
Maximum number of operations per minute	5	
Maximum number of switching operation a day	100	
Additional characteristics to IEC/EN 60947-3		
Insulation voltage (Ui)	440 V AC	
Pollution degree	3	
Rated impulse withstand voltage (Uimp)	6 kV	
Endurance (O-C)		
Electrical to IEC/EN 60947-3	200,000 cycles (AC21)	50,000 cycles (AC21)
	100,000 cycles (AC22)	20,000 cycles (AC22)
Overvoltage category	IV	
Other characteristics		
Degree of protection (IEC 60529)	Device only	IP20
	Device in modular enclosure	IP40 Insulation class II
Operating temperature	-20°C to +50°C	
Storage temperature	-40°C to +70°C	
Tropicalization (IEC 60068-1)	Treatment 2 (relative humidity 95 % at 55°C)	



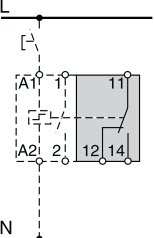
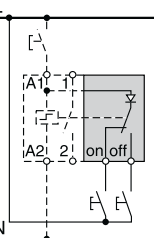
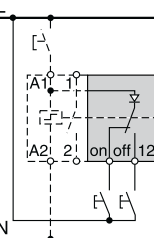
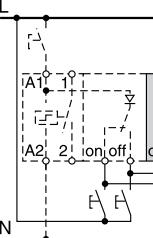

iTL impulse relays

Electrical auxiliaries for iTL impulse relays

		Indication		Control	
Auxiliaries		iATLs		iATLc	
Type		Indication		Centralised control	
				Centralised control + indication	
				Multi-level centralised control	
					
Function		<ul style="list-style-type: none"> Allows remote indication of the associated impulse relay 		<ul style="list-style-type: none"> Used for centralised control, thanks to a "pilot line", of a group of impulse relays controlling separate networks, while at the same time maintaining local individual control of each impulse relay And for remote indication of the mechanical status of each relay 	
Wiring diagrams					
				<ul style="list-style-type: none"> Each group, made up of iTLc or (iTL or iTLI or iTLs) + iATLc+s, must only contain a single iATLc+c Maximum number of impulse relays that can be controlled: <ul style="list-style-type: none"> 230 V AC: 24 130 V AC: 12 48 V AC: 5 	
Mounting		<ul style="list-style-type: none"> Mounted to the right of iTL by yellow clips 		<ul style="list-style-type: none"> Mounted to the right of iTL by yellow clips 	
Catalogue numbers		A9C15405		A9C15404	
				A9C15409	
				A9C15410	
Technical specifications					
Control voltage (Ue)	V AC	24...240	24...240	24...240	24...240
	V DC	24...240	—	—	—
Control voltage frequency	Hz	50/60	50/60	50/60	50/60
	Width in 9 mm modules	1	1	2	2
Auxiliary contact (breaking capacity)	<ul style="list-style-type: none"> Minimum: 10 mA at 24 V AC/DC Maximum (IEC 60947-5-1): <ul style="list-style-type: none"> 12...240 V AC 6 A 12...24 V DC 6 A 15...240 V AC 2 A 13...24 V DC 2 A 				
	<ul style="list-style-type: none"> Minimum: 10 mA at 24 V AC/DC Maximum (IEC 60947-5-1): <ul style="list-style-type: none"> 12...240 V AC 6 A 12...24 V DC 6 A 15...240 V AC 2 A 13...24 V DC 2 A 				
	—				
	—				
	—				
Number of contacts	—				
Operating temperature	°C	-20°C to +50°C			
Storage temperature	°C	-40°C to +70°C			

iTL impulse relays Electrical auxiliaries for iTL impulse relays (cont.)

Control

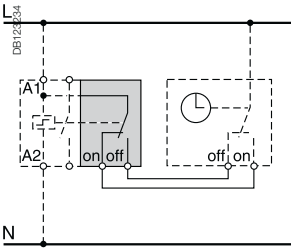
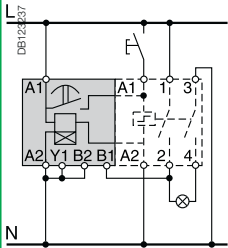
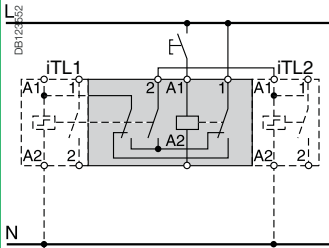
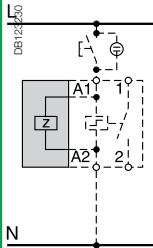
iATLm	iATEt	iATL4	iATLz
Latched control	Time delay	Step by step control	Control by illuminated push-buttons
			
<ul style="list-style-type: none"> Combined with an impulse relay, it operates on latched orders 	<ul style="list-style-type: none"> Combined with an impulse relay, it automatically disconnects the circuit after a preset time 	<ul style="list-style-type: none"> Allows the step by step sequence over 2 circuits 	<ul style="list-style-type: none"> Used to control impulse relays by illuminated push-buttons, without operating risks
			
-	<ul style="list-style-type: none"> 5 time setting ranges: <ul style="list-style-type: none"> 1 to 10 s 6 to 60 s 2 to 10 min 6 to 60 min 2 to 10 h 	<ul style="list-style-type: none"> The cycle is as follows: <ul style="list-style-type: none"> 1st impulse - iTL 1 closed, iTL 2 open 2nd impulse - iTL 1 open, iTL 2 closed 3rd impulse - iTL 1 and 2 closed 4th impulse - iTL 1 and 2 open 5th impulse - iTL 1 closed, iTL 2 open, etc 	<ul style="list-style-type: none"> Provide an iATLz when the current drawn up by the illuminated push-buttons is higher than 3 mA (this current is sufficient to keep the coils energised). Above this value, fit one extra iATLz per 3 mA. For example: for 7 mA, fit 2 iATLz
<ul style="list-style-type: none"> Mounted to the right of iTL by yellow clips 	<ul style="list-style-type: none"> Mounted to the left of iTL by yellow clips 	<ul style="list-style-type: none"> Assembled between 2 impulse relays: according to the auxiliarisation table by yellow clips 	<ul style="list-style-type: none"> Mounted to the left of iTL by yellow clips
A9C15414	A9C15419	A9C15412	A9C15413
12...240	24...240	230	130...240
6...110 50/60	24...110 50/60	- 50/60	- 50/60
1	2	4	2
-	-	-	-
-	-	-	-
-20°C to +50°C	-	-	-
-40°C to +70°C	-	-	-

iTL impulse relays Electrical auxiliaries for iTL impulse relays (cont.)

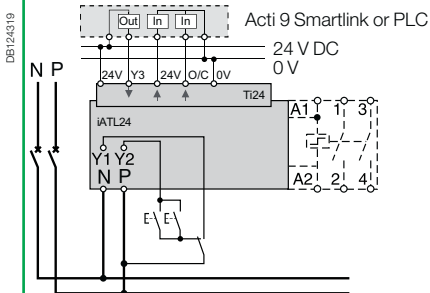
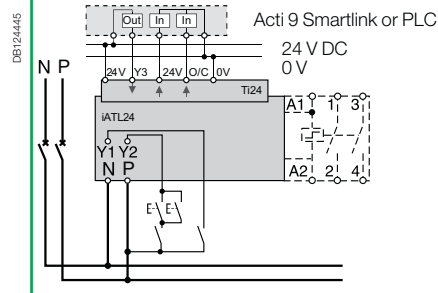
		Control and indication	
Auxiliaire	iATL24		
Type	Control and indication 24 V DC		
	With Ti24 connector		
			
Function	<ul style="list-style-type: none"> ■ This auxiliary allows a impulse relay to be interfaced with the Acti 9 Smartlink interface or a programmable logic controller (PLC) in 24 V DC (control, O/C indication) ■ 230 V AC control 		
Wiring diagrams	<div style="display: flex; justify-content: space-around;"> <div style="width: 45%;">  <p>Wiring with exclusive selector 230 V AC and 24 V DC controls</p> </div> <div style="width: 45%;">  <p>Wiring for non-exclusive 230 V AC and 24 V DC controls</p> </div> </div>		
Mounting	<ul style="list-style-type: none"> ■ To the left of the iTL impulse relay using the yellow clips⁽¹⁾. ■ When an iATL24 is used, the A1/A2 terminals of the impulse relay should not be wired. Only the yellow clips integral with the iATL24 should be used for connection to the coil. 		
Utilization	<ul style="list-style-type: none"> ■ 230 V AC interface: <ul style="list-style-type: none"> □ Y1: enabling of 24 V DC control (Y1 = 1) or inhibition of 24 V DC control (Y1 = 0). □ Y2: 230 V pulse control ■ "Ti24" 24 V DC interface: <ul style="list-style-type: none"> □ Y3: 24 V DC control of iTL closing on rising edge and opening on falling edge □ reading of the impulse relay status (opened or closed) from the position of the integrated O/C auxiliary contact □ monitoring of connection of the "Ti24" terminal block by the upstream system (PLC, supervision system) via the 24 V terminal (in the centre of the Ti24 terminal block) 		
Catalogue numbers	A9C15424		
Technical specifications			
Control voltage (Ue)	V AC	230, +10 %, -15 % (Y2)	
	V DC	24, ± 20 % (Y3)	
Control voltage frequency	Hz	50/60	
Insulation voltage (Ui)	V AC	250	
Rated impulse withstand voltage (Uimp)	kV	8 (OVC IV)	
Pollution degree	3		
Degree of protection	IP20B device only		
	IP40 device in modular enclosure		
Width in 9 mm modules	2		
Auxiliary contact (O/C) Ti24	24 V DC protected output, min. 2 mA, max. 100 mA		
Contact	1 O/C operating category AC 14		
Operating temperature	°C	-25°C to +60°C	
Storage temperature	°C	-40°C to +80°C	
Consumption	<1 W		
Standard	IEC/EN 60947-5-1		

(1) Mechanical and electrical connection.

iTL impulse relays

Electrical auxiliaries for iTL impulse relays (cont.)



Operation of the iATL24

O/C 24 V DC output

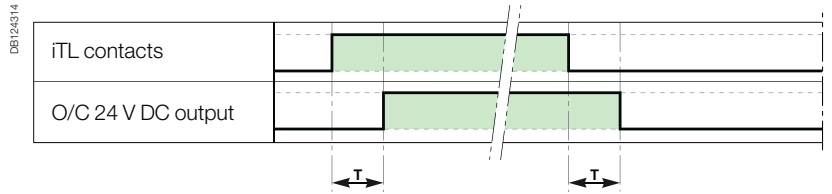

Parameter	Min	Max
T	100 ms	200 ms

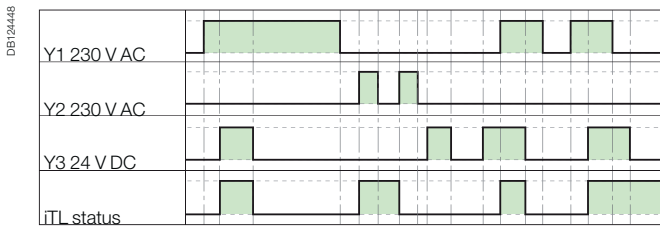
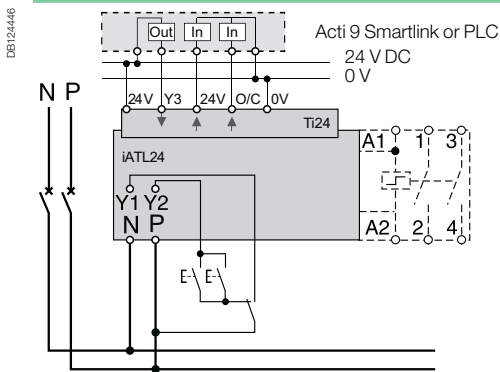

- Minimum duration of 230 V AC pulse (Y2): 200 ms.
- 30 iATL24 closing or opening actuations are authorized per minute: Minimum time delay between 2 actuations on the iATL24 via Y1, Y2, Y3 (closing or opening of the iTL coil): 440 ms.
- 10 closing or opening actuations spaced 440 milliseconds apart are authorized following no loading of the iATL24 during a period of 20 seconds.

Wiring with exclusive selector 230 V AC and 24 V DC controls

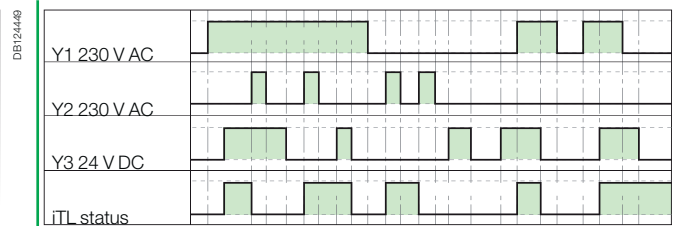
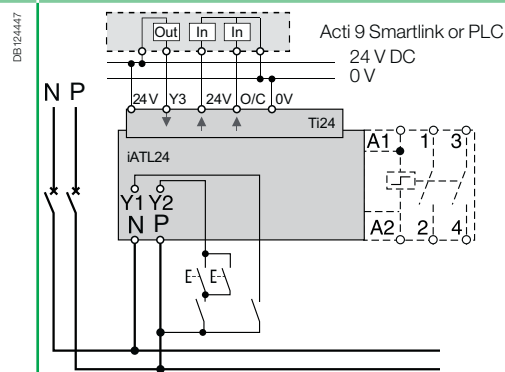

Wiring for non-exclusive 230 V AC and 24 V DC controls



		Security	
Accessories	Yellow clips	Spacer	
	 PB106143-10	 PB104483	
Function			
	<ul style="list-style-type: none"> ■ Ensure the mechanical and/or electrical link between impulse relays and their auxiliaries (set of 10). 		<ul style="list-style-type: none"> ■ Required to reduce temperature rise of modular devices installed side by side. ■ Recommended to separate electronic devices (thermostat, programmable clock, etc.) from electromechanical devices (relays, contactors).
Catalogue numbers		A9C15415	A9A27062
Technical specifications			
Width in 9 mm modules		-	1

Dimensions (mm)

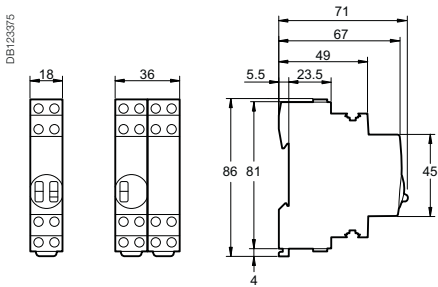

iTL 1P
iTLc
iTLm
iTLs
iTLi
iETL

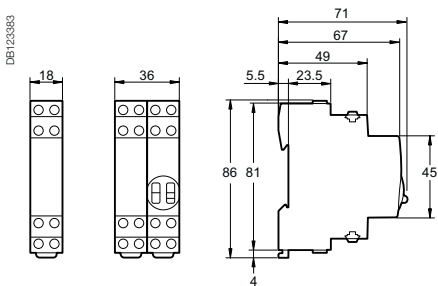

iATLc+s
iATLc+c
iATLz
iATL4

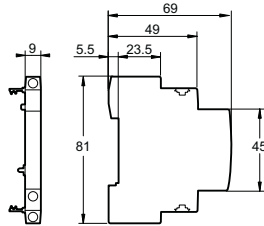

iATLc
iATLs
iATLm

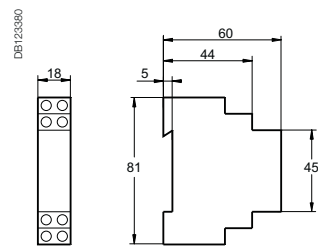

iATeT

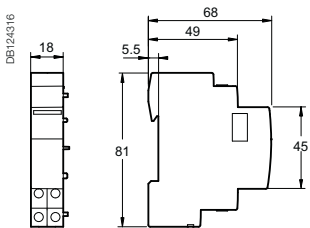

iATL24

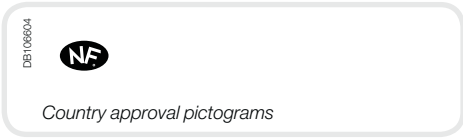

EN 60669-2-2

The iTL+ high-performance impulse relay allows remote control of single-phase circuits. It is designed for demanding applications.

The iTL+ high-performance impulse relay is used for push-button control of lighting circuits consisting of:

- incandescent lamps, low-voltage halogen lamps, etc. (resistive loads)
- fluorescent tubes, discharge lamps, etc. (inductive loads).

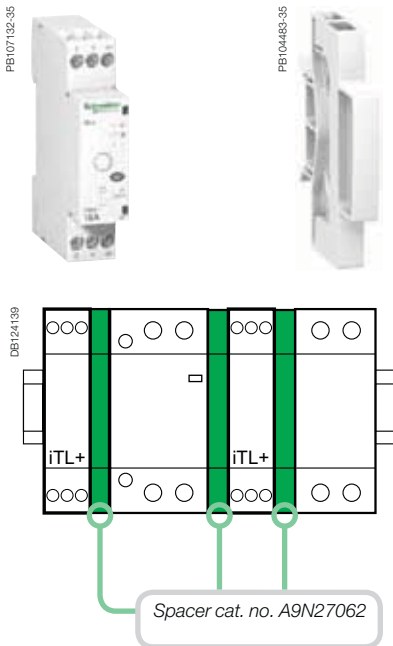

iTL+			
Type	Rating		Width in 9 mm modules
1P+N	16 A	A9C15032	2+1 ⁽¹⁾

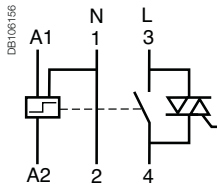

(1) Supplied with a 9 mm spacer (cat. no. A9N27062); to be used for mounting the iTL+ alongside a circuit breaker, contactor, impulse relay, etc., in order to maintain optimal operation.



It is compulsory:

- to connect the neutral
- to keep the same control circuit connection "A1: phase", "A2: neutral"
- to use the same phase for connection of the power and control functions.

Operation

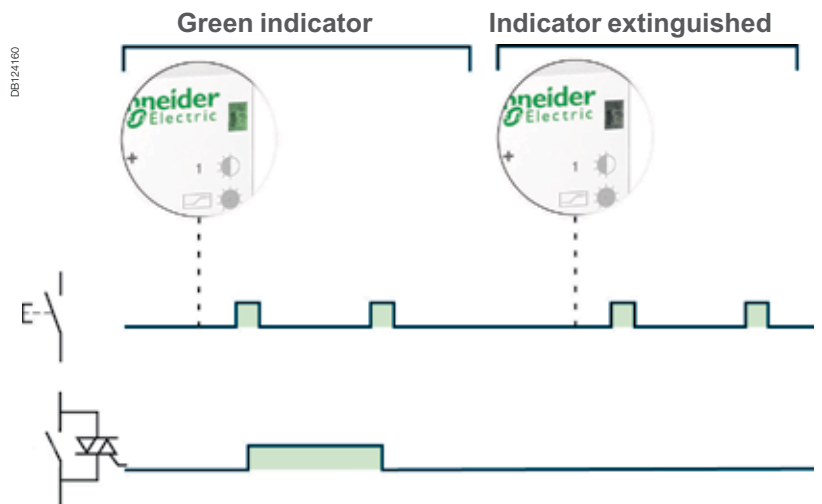

Connection

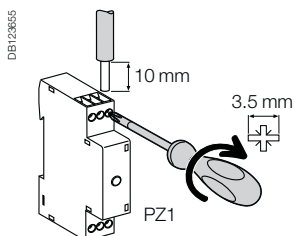

Type	Rating	Tightening torque	Copper cables	
			Rigid or flexible with ferrule	Rigid or flexible without ferrule
iTL+	16 A	1 N.m	 2 x 1.5 mm ²	 2 x 2.5 mm ² 1 x 4 mm ²

iTL+ high-performance impulse relays (cont.)

They combine the benefits of static switching and electromechanical technology: small size, little temperature rise.

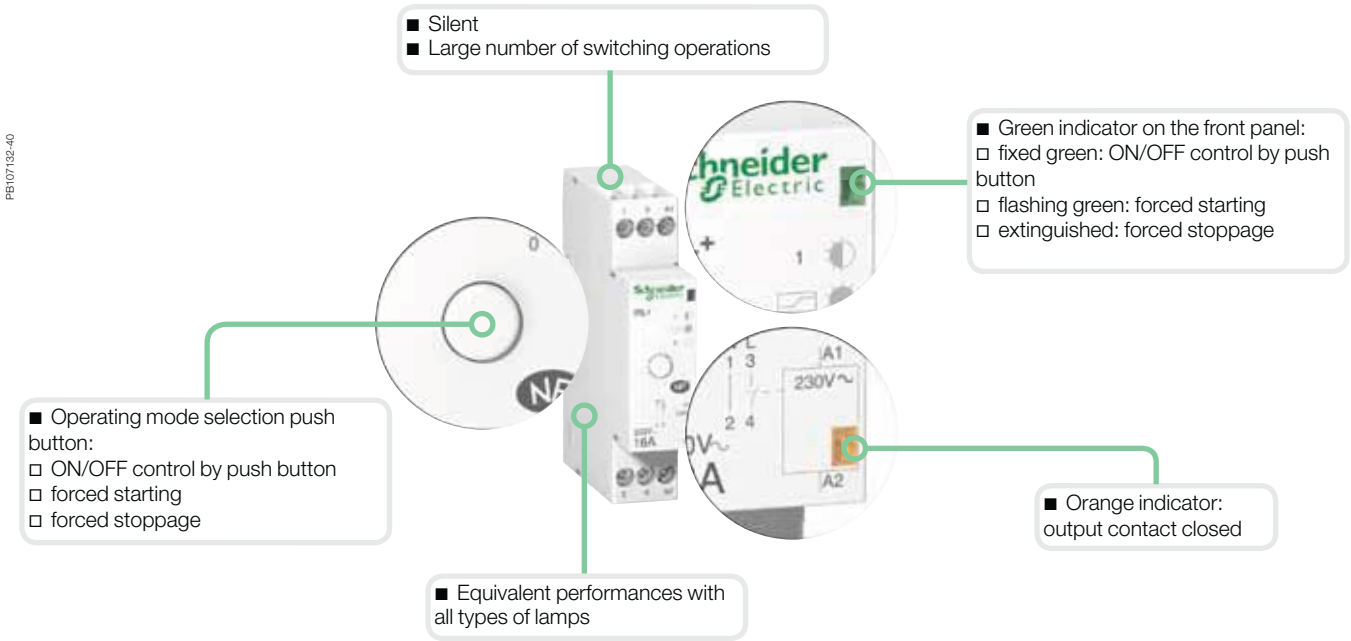

Following a mains failure, the iTL+ returns to 0 position (forced stoppage) irrespective of its initial state.

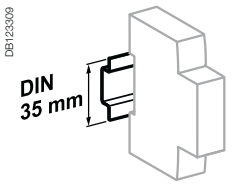

Clip on DIN rail 35 mm.

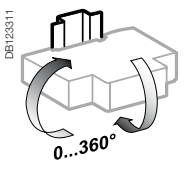

Indifferent position of installation.

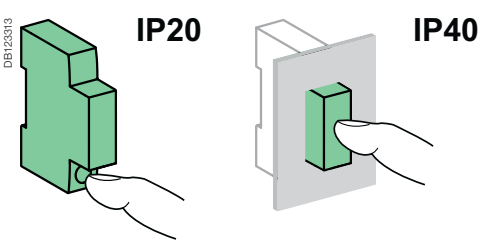

Technical data

Control circuit		
Coil voltage (Uc)		230 V AC
Frequency		50 Hz
Inrush power		11 VA
Holding power		1.1 VA
Control by luminous push button		Max. current 5 mA
Control order duration		50 ms to 1 s (recommended 200 ms)
Power circuit		
Voltage rating (Ue)		230 V AC
Frequency		50 Hz
Electrical load	Minimum	20 W
	Maximum	3600 W
Max. number of switching operations per minute		6
Other characteristics		
Degree of protection (IEC 60529)	Device only	IP20
	Device in modular enclosure	IP40
		Insulation class II
Endurance (O-C)	Electrical	5.000.000 cycles (AC21 - AC22)
Noise level at activation		< 30 dBA
Operating temperature		-5°C to +55°C
Storage temperature		-40°C to +60°C
Tropicalization (IEC 60068-1)		Treatment 2 (relative humidity of 95 % at 55°C)

Weight (g)

High-performance impulse relays	
Type	iTL+
1P+N	70