

REVISIONS

P	LTR	DESCRIPTION	DATE	DWN	APVD
	BA	NEW DRAWING	06FEB2026	CK	TG

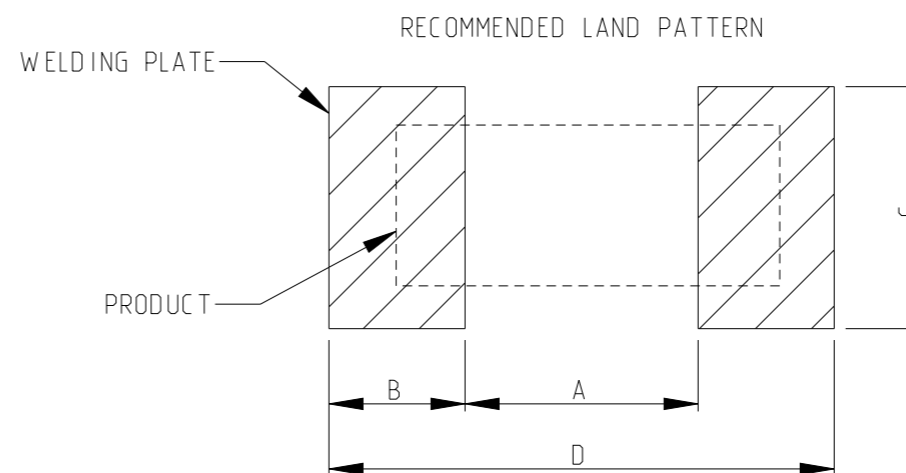
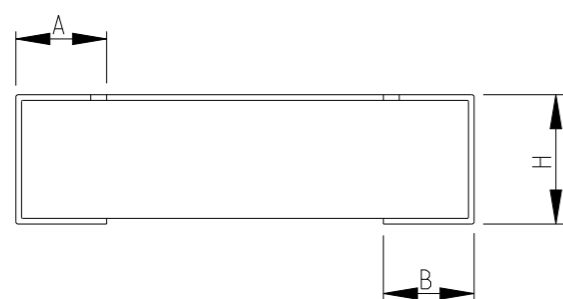
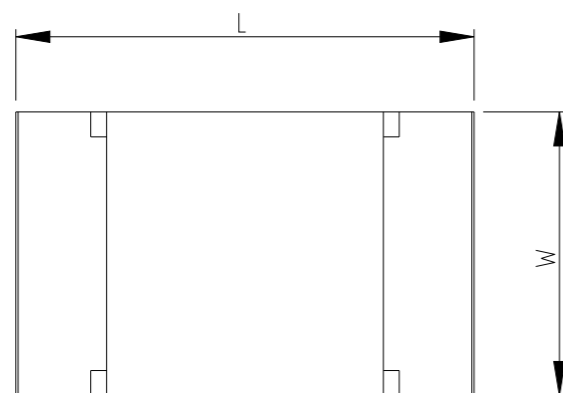

TEST BOARD CONSTRUCTION:
 PCB THICKNESS : 1.6mm SINGLE SIDED.
 COPPER LAYER THICKNESS : 32-36 μm

TYPE	SIZE (Inch)	A (mm)	B (mm)	C (mm)	D (mm)
CRGSP0805	0805	1.0±0.10	1.00±0.10	1.40±0.10	3.00±0.10

NOTES:

1. FOR FURTHER INFORMATION SEE DATA SHEET FOR CRGSP SERIES THICK FILM ANTI-SULPHUR PULSE CHIP RESISTOR

TYPE	SIZE (Inch)	L (mm)	W (mm)	H (mm)	A (mm)	B (mm)	UNIT WEIGHT (mg)
CRGSP0805	0805	2.00±0.15	1.25+0.15/-0.10	0.55±0.10	0.40±0.20	0.40±0.20	4.74

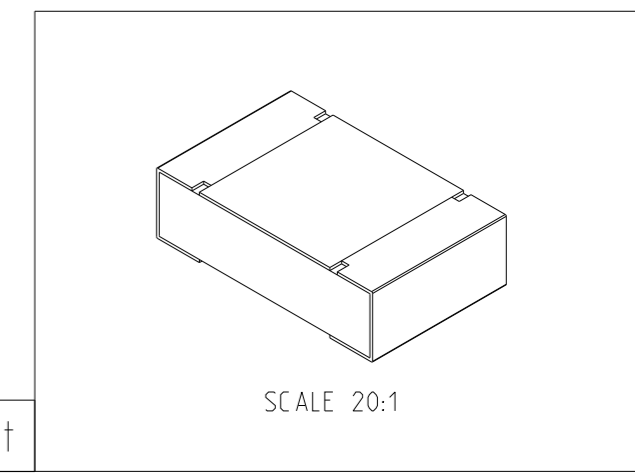

RoHS Compliant

THIS DRAWING IS A CONTROLLED DOCUMENT.		DWN 06FEB2026 CHANDRA K														
DIMENSIONS: mm		CHK 06FEB2026 TRACY G														
TOLERANCES UNLESS OTHERWISE SPECIFIED:		APVD 06FEB2026 TRACY G	NAME THICK FILM ANTI-SULPHUR PULSE CHIP RESISTOR TYPE CRGSP 0805 SERIES													
<table border="0"> <tr><td>0 PLC</td><td>±</td></tr> <tr><td>1 PLC</td><td>±</td></tr> <tr><td>2 PLC</td><td>±</td></tr> <tr><td>3 PLC</td><td>±</td></tr> <tr><td>4 PLC</td><td>±</td></tr> <tr><td>ANGLES</td><td>±</td></tr> </table>		0 PLC	±	1 PLC	±	2 PLC	±	3 PLC	±	4 PLC	±	ANGLES	±	PRODUCT SPEC	-	
0 PLC	±															
1 PLC	±															
2 PLC	±															
3 PLC	±															
4 PLC	±															
ANGLES	±															
MATERIAL		APPLICATION SPEC	-													
-		WEIGHT	-													
-		CUSTOMER DRAWING	SCALE 30:1	SHEET 1 OF 3												
			SIZE A3	CAGE CODE 00779												
			DRAWING NO. C=72232	RESTRICTED TO -												
				REV BA												

REVISIONS

P	LTR	DESCRIPTION	DATE	DWN	APVD
	-	SEE SHEET 1	-	-	-

SCHEDULE			
TCPN	CATALOGUE NUMBER	PART DESCRIPTION	PART STATUS
72232-1	CRGSP0805FZR	CRGSP0805 1% ZR	PRODUCTION
72232-2	CRGSP0805F1R0	CRGSP0805 1% 1R0	PRODUCTION
72232-3	CRGSP0805F10R	CRGSP0805 1% 10R	PRODUCTION
72232-4	CRGSP0805F20R	CRGSP0805 1% 20R	PRODUCTION
72232-5	CRGSP0805F49R9	CRGSP0805 1% 49R9	PRODUCTION
72232-6	CRGSP0805F100R	CRGSP0805 1% 100R	PRODUCTION
72232-7	CRGSP0805F1K0	CRGSP0805 1% 1K0	PRODUCTION
72232-8	CRGSP0805F1K5	CRGSP0805 1% 1K5	PRODUCTION
72232-9	CRGSP0805F2K0	CRGSP0805 1% 2K0	PRODUCTION
1-72232-0	CRGSP0805F7K5	CRGSP0805 1% 7K5	PRODUCTION
1-72232-1	CRGSP0805F10K	CRGSP0805 1% 10K	PRODUCTION
1-72232-2	CRGSP0805F20K	CRGSP0805 1% 20K	PRODUCTION
1-72232-3	CRGSP0805F49K9	CRGSP0805 1% 49K9	PRODUCTION
1-72232-4	CRGSP0805F75K	CRGSP0805 1% 75K	PRODUCTION
1-72232-5	CRGSP0805F100K	CRGSP0805 1% 100K	PRODUCTION
1-72232-6	CRGSP0805F150K	CRGSP0805 1% 150K	PRODUCTION
1-72232-7	CRGSP0805F200K	CRGSP0805 1% 200K	PRODUCTION
1-72232-8	CRGSP0805F1M0	CRGSP0805 1% 1M0	PRODUCTION
1-72232-9	CRGSP0805F2M0	CRGSP0805 1% 2M0	PRODUCTION
2-72232-0	CRGSP0805F10M	CRGSP0805 1% 10M	PRODUCTION
2-72232-1	CRGSP0805F2R0	CRGSP0805 1% 2R0	PRODUCTION
2-72232-2	CRGSP0805F4R7	CRGSP0805 1% 4R7	PRODUCTION
2-72232-3	CRGSP0805F5R1	CRGSP0805 1% 5R1	PRODUCTION
2-72232-4	CRGSP0805F22R	CRGSP0805 1% 22R	PRODUCTION
2-72232-5	CRGSP0805F47R	CRGSP0805 1% 47R	PRODUCTION
2-72232-6	CRGSP0805F51R	CRGSP0805 1% 51R	PRODUCTION
2-72232-7	CRGSP0805F120R	CRGSP0805 1% 120R	PRODUCTION
2-72232-8	CRGSP0805F180R	CRGSP0805 1% 180R	PRODUCTION
2-72232-9	CRGSP0805F330R	CRGSP0805 1% 330R	PRODUCTION

SCHEDULE			
TCPN	CATALOGUE NUMBER	PART DESCRIPTION	PART STATUS
3-72232-0	CRGSP0805F470R	CRGSP0805 1% 470R	PRODUCTION
3-72232-1	CRGSP0805F510R	CRGSP0805 1% 510R	PRODUCTION
3-72232-2	CRGSP0805F680R	CRGSP0805 1% 680R	PRODUCTION
3-72232-3	CRGSP0805F820R	CRGSP0805 1% 820R	PRODUCTION
3-72232-4	CRGSP0805F910R	CRGSP0805 1% 910R	PRODUCTION
3-72232-5	CRGSP0805F1K2	CRGSP0805 1% 1K2	PRODUCTION
3-72232-6	CRGSP0805F1K6	CRGSP0805 1% 1K6	PRODUCTION
3-72232-7	CRGSP0805F2K4	CRGSP0805 1% 2K4	PRODUCTION
3-72232-8	CRGSP0805F3K0	CRGSP0805 1% 3K0	PRODUCTION
3-72232-9	CRGSP0805F4K64	CRGSP0805 1% 4K64	PRODUCTION
4-72232-0	CRGSP0805F4K7	CRGSP0805 1% 4K7	PRODUCTION
4-72232-1	CRGSP0805F5K1	CRGSP0805 1% 5K1	PRODUCTION
4-72232-2	CRGSP0805F6K8	CRGSP0805 1% 6K8	PRODUCTION
4-72232-3	CRGSP0805F12K	CRGSP0805 1% 12K	PRODUCTION
4-72232-4	CRGSP0805F15K	CRGSP0805 1% 15K	PRODUCTION
4-72232-5	CRGSP0805F27K	CRGSP0805 1% 27K	PRODUCTION
4-72232-6	CRGSP0805F34K8	CRGSP0805 1% 34K8	PRODUCTION
4-72232-7	CRGSP0805F39K	CRGSP0805 1% 39K	PRODUCTION
4-72232-8	CRGSP0805F47K	CRGSP0805 1% 47K	PRODUCTION
4-72232-9	CRGSP0805F68K	CRGSP0805 1% 68K	PRODUCTION
5-72232-1	CRGSP0805F110K	CRGSP0805 1% 110K	PRODUCTION
5-72232-2	CRGSP0805F120K	CRGSP0805 1% 120K	PRODUCTION
5-72232-3	CRGSP0805F180K	CRGSP0805 1% 180K	PRODUCTION
5-72232-4	CRGSP0805F220K	CRGSP0805 1% 220K	PRODUCTION
5-72232-5	CRGSP0805F240K	CRGSP0805 1% 240K	PRODUCTION
5-72232-6	CRGSP0805F270K	CRGSP0805 1% 270K	PRODUCTION
5-72232-7	CRGSP0805F300K	CRGSP0805 1% 300K	PRODUCTION
5-72232-8	CRGSP0805F330K	CRGSP0805 1% 330K	PRODUCTION
5-72232-9	CRGSP0805F470K	CRGSP0805 1% 470K	PRODUCTION

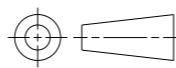
THIS DRAWING IS A CONTROLLED DOCUMENT.		DWN CHANDRA K 06FEB2026	 TE Connectivity NAME THICK FILM ANTI-SULPHUR PULSE CHIP RESISTOR TYPE CRGSP 0805 SERIES	
DIMENSIONS: mm		CHK TRACY G 06FEB2026		
		APVD TRACY G 06FEB2026		
TOLERANCES UNLESS OTHERWISE SPECIFIED:		PRODUCT SPEC	SIZE	
0 PLC ±		-	CAGE CODE	
1 PLC ±		APPLICATION SPEC	DRAWING NO	
2 PLC ±		-	RESTRICTED TO	
3 PLC ±		WEIGHT	A3 00779 C=72232	
4 PLC ±		-	SCALE 30:1 SHEET 2 OF 3 REV BA	
ANGLES ±		-		
FINISH		-		
MATERIAL		-		
-		-		
-		-		

REVISIONS

P	LTR	DESCRIPTION	DATE	DWN	APVD
-		SEE SHEET 1	-	-	-

SCHEDULE			
TCPN	CATALOGUE NUMBER	PART DESCRIPTION	PART STATUS
6-72232-0	CRGSP0805F680K	CRGSP0805 1% 680K	PRODUCTION
6-72232-1	CRGSP0805F750K	CRGSP0805 1% 750K	PRODUCTION
6-72232-2	CRGSP0805F1M2	CRGSP0805 1% 1M2	PRODUCTION
6-72232-3	CRGSP0805F1M5	CRGSP0805 1% 1M5	PRODUCTION
6-72232-4	CRGSP0805F1M8	CRGSP0805 1% 1M8	PRODUCTION
6-72232-5	CRGSP0805F2M2	CRGSP0805 1% 2M2	PRODUCTION
6-72232-6	CRGSP0805F3M0	CRGSP0805 1% 3M0	PRODUCTION
6-72232-7	CRGSP0805F3M3	CRGSP0805 1% 3M3	PRODUCTION
6-72232-8	CRGSP0805F3M6	CRGSP0805 1% 3M6	PRODUCTION
6-72232-9	CRGSP0805F3M9	CRGSP0805 1% 3M9	PRODUCTION
7-72232-0	CRGSP0805F4M3	CRGSP0805 1% 4M3	PRODUCTION
7-72232-1	CRGSP0805F4M7	CRGSP0805 1% 4M7	PRODUCTION

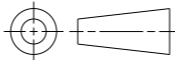
THIS DRAWING IS A CONTROLLED DOCUMENT.		DWN CHANDRA K 06FEB2026	 TE Connectivity	
DIMENSIONS: mm		CHK TRACY G 06FEB2026		
TOLERANCES UNLESS OTHERWISE SPECIFIED:		APVD TRACY G 06FEB2026	NAME THICK FILM ANTI-SULPHUR PULSE CHIP RESISTOR TYPE CRGSP 0805 SERIES	
		PRODUCT SPEC -	RESTRICTED TO -	
MATERIAL -		FINISH -	APPLICATION SPEC -	SIZE A3
		WEIGHT -	CAGE CODE 00779	DRAWING NO G=72232
		CUSTOMER DRAWING	SCALE 30:1	SHEET 3 OF 3
			REV BA	