

PDA102

AUDIO-FREQUENCY INDUCTION LOOP AMPLIFIER

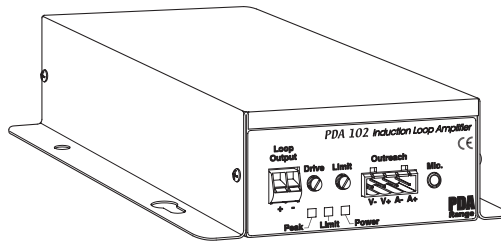
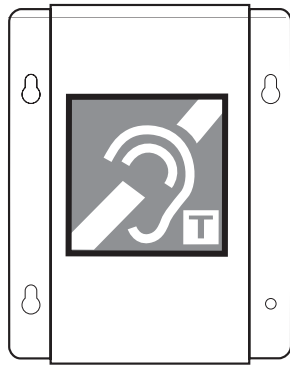

INSTALLATION INSTRUCTIONS

This equipment must be installed by a suitably skilled and technically competent person. Please read these instructions carefully before installation.

Important notes	2
PDA102 kit contents	2
What is an audio frequency induction loop system?	3
Familiarisation with your PDA102 induction loop amplifier	4
Planning the system	5
Overview of the 'Outreach plate' audio input extension system	10
Installation	11
Safety precautions	11
Mounting the amplifier	11
Connecting and testing the system	12
Troubleshooting	14
Technical specification	15



Important notes

These instructions are general and cannot be considered to cover every aspect of audio-frequency induction loop system design and installation.

We recommend you also read BS7594 (The Code of Practice for Audio-Frequency Induction Loop Systems) and EN60118-4 (Magnetic field strength in audio frequency induction loop systems for hearing aid purposes), copies of which are available from the British Standards Institute, 389 Chiswick High Road, London W4 4AL. Tel: +44 (0)20 8996 9000. Web: www.bsi-global.com. It should be noted that all of the above documents can be subject to update or revision at any time and we recommend you check the status of them with the BSI before ordering.

Other National standards of design/installation/commissioning should be referenced where pertinent.

PDA102 kit contents

The PDA102 induction loop amplifier is available in the following kit formats. Please ensure that the accessories shown are included in the kit you have purchased.

PDA102C 1.2m² Counter Kit

- 1 x PDA102 audio frequency induction loop amplifier
- 1 x AC power lead
- 1 x TX121 Counter loop cable and fixings
- 1 x AMT Omni-directional tie/desk microphone c/w 1.5m (5ft) lead and attachments
- 1 x Installation manual (i.e. this manual)
- 1 x Accessory pack containing four stick-on cabinet feet, four wall-mounting screws, one four-way 'Outreach' connector and two 'induction loop in use' stickers.

PDA102R 50m² Small Room Kit ('Outreach' plated mic. version)

- 1 x PDA102 audio frequency induction loop amplifier
- 1 x AC power lead
- 1 x APM Omni-directional 'outreach' plated microphone c/w 6m (20ft) connection cable
- 1 x 30m (98ft) reel of 0.5mm² induction loop cable
- 1 x Installation manual (i.e. this manual)
- 1 x Accessory pack containing four stick-on cabinet feet, four wall-mounting screws, one four-way 'Outreach' connector and two 'induction loop in use' stickers.

PDA102L 50m² Small Room Kit (tie/desk mic. version)

- 1 x PDA102 audio frequency induction loop amplifier
- 1 x AC power lead
- 1 x AMT Omni-directional tie/desk microphone c/w 1.5m (5ft) lead and attachments
- 1 x 30m (98ft) reel of 0.5mm² induction loop cable
- 1 x Installation manual (i.e. this manual)
- 1 x Accessory pack containing four stick-on cabinet feet, four wall-mounting screws, one four-way 'Outreach' connector and two 'induction loop in use' stickers.

PDA102S 50m² TV Lounge Kit

- 1 x PDA102 audio frequency induction loop amplifier
- 1 x AC power lead
- 1 x APL Double phono line level 'outreach' connection plate
- 1 x APS SCART to phono audio connection lead
- 1 x 30m (98ft) reel of 0.5mm² induction loop cable
- 1 x Installation manual (i.e. this manual)
- 1 x Accessory pack containing four stick-on cabinet feet, four wall-mounting screws, one four-way 'Outreach' connector and two 'induction loop in use' stickers.

PDA102 Amplifier and AC Power Lead ONLY

- 1 x PDA102 audio frequency induction loop amplifier
- 1 x AC power lead
- 1 x Accessory pack containing four stick-on cabinet feet, four wall-mounting screws, one four-way 'Outreach' connector and two 'induction loop in use' stickers.

What is an audio frequency induction loop system?



An audio-frequency induction loop system (AFILS) allows hearing impaired people to hear more clearly.

Most hearing aids have a 'T' or 'MT' switch which allows them to pick up the electromagnetic field generated by an induction loop system. The hearing aid converts this signal into a sound suited to its user's specific hearing requirements.

Any hearing impaired person positioned within or near the loop can hear the loop signal by switching their hearing aid to the correct position, allowing them to participate more effectively in general conversation, ordering goods or services, listening to public performances, etc.

An induction loop system therefore comprises four main elements:-

The audio source – typically a microphone, television or radio (or a combination of these).

The induction loop amplifier

The loop – typically a single turn of wire usually run around the perimeter of the room or, for ticket counter installations, a special counter loop fixed to the underside of the counter surface.

The receiver(s) – any behind-the-ear type hearing aid with a 'T' or 'MT' switch.

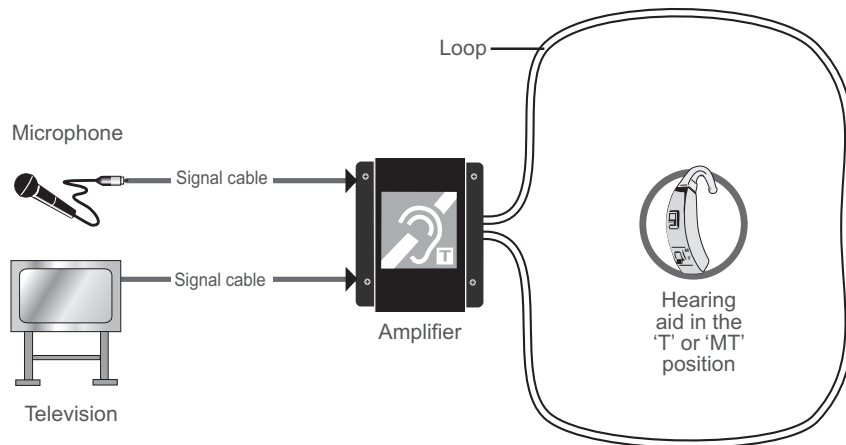

Familiarisation with your PDA102 induction loop amplifier

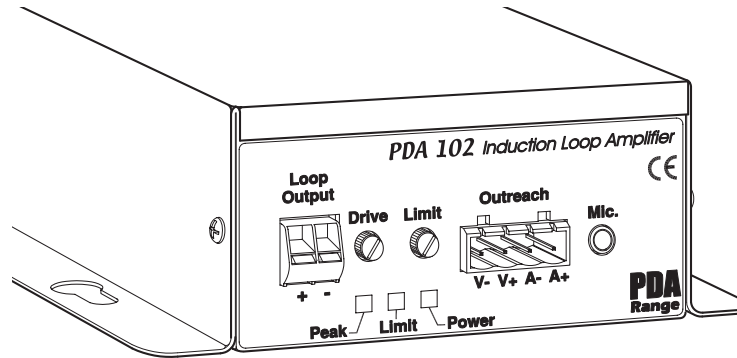

The PDA102 is a true current mode wall or desk mountable induction loop amplifier designed to cover ticket counters up to 1.2m² (PDA102C) or rooms up to 50m² (PDA102L/R/S).

It includes a 3.5mm electret microphone (**Mic.**) input with 9V phantom power and a four-way '**Outreach**' input offering full compatibility with our Outreach plate audio input extension system. This system allows the connection of multiple microphone or line level inputs via a range of specially designed single gang connector plates (see page 10 for further details).

The PDA102 mixes and amplifies the microphone and outreach input signals and feeds them through its sophisticated automatic gain control (AGC) circuitry before outputting them to the induction loop.

The induction loop connects to the amplifier via two 'push-and-hold' connectors at the terminal marked **Loop Output**.

Two rotary screwdriver-adjustable level controls (**Drive** and **Limit**) and three LED indicators (**Power**, **Limit** and **Peak**) are also provided.

The **Limit** control adjusts the input sensitivity level so that the mixed microphone/outreach signal is set at the right level for the AGC circuitry.

The **Drive** control adjusts the strength of the magnetic field that is generated by the induction loop.

The **Peak** indicator illuminates red in line with peaks in the input signal.

The **Limit** indicator confirms the AGC circuit is functioning. The rate at which this indicator is lit will depend upon the type of signal being fed into the amplifier. For example, if the signal is speech based, the indicator will only light when someone is talking into the microphone. If the system is used to amplify music, the indicator will normally be lit more constantly.

The **Power** indicator illuminates green when the amplifier is powered up.

The amplifier is supplied with an AC power cord which connects to the terminal marked 230V 50/60Hz 20W located at the bottom of the amplifier.

Planning the system

Induction loop design and installation can be simple provided that a few basic facts are understood. To help avoid poor performance and the need to re-position the amplifier or loop cable at a later stage, we strongly recommend you refer to the hints and tips below and the relevant typical system diagram on pages 6 to 9 before proceeding.

Maximum area coverage

The approximate coverage provided by the PDA102C counter loop system is 1.2m² and the maximum square room coverage provided by the PDA102L, S & R is 49m² (i.e. a room up to 7 x 7m in size). Longer rooms can be covered provided the area does not exceed 49m², i.e. 4m x 12m (48m²).

Loop cable selection

The loop is normally a single turn of wire placed horizontally around the area to be covered. Only use the loop cable supplied with your PDA102 amplifier (PDA102C/R/L/S kits only). If you have purchased a non-kit variant of the PDA102, we recommend the use of 0.5mm² tri-rated cable such as our own LOOP1/B or LOOP1/W cable, available in 100m reels. Note that 0.5mm² Flat copper foil tape (part no FLAT1005) is also available and that some installers prefer to use this as a floor loop under light duty carpets.

Loop cable position

The field strength in the plane of the loop (the height at which the cable is positioned) varies greatly so it is best to install the loop above or below the listener at floor or ceiling height. The loop field will not be as strong but it will be much more even and provide better results. Listening height (with the hearing aid user sitting or standing) is normally 0.9 to 1.8m from the floor). Large amounts of metal can affect the strength of the loop field so avoid running loops along girders or under floor mesh. On floor loops, avoid running the loop up and over door openings as there will be a 'dead spot' (i.e. no signal) when the hearing aid user passes through.

Trial loops

Always run a trial loop and test to evaluate performance by listening to the signal with either a hearing aid or a dedicated loop test receiver. To ensure the system complies with BS7594 we recommend you also test the system using a pink noise generator and magnetic field strength meter. Refer to **connecting and testing the system**, page 12, for further details.

Overspill and 'cross-talk'

The signal generated by the loop will radiate outside as well as inside the loop. If there are any other loop systems in close proximity, overspill such as this may lead to 'cross-talk' (signals from different loops merging into one). If this is likely to be an issue, special designs of loop can be implemented to help reduce the overspill field - contact your supplier for details.

Additional microphone or line level inputs

Some loop systems require more than one microphone or line level input. The PDA102's 'Outreach' connector facilitates straightforward system expansion by allowing the connection of additional microphones and other audio sources. See page 10 for further details.

The 'isolation' issue

When a hearing aid user switches his or her hearing aid to the 'T' position, its on-board microphone is switched off and the only noise that can be heard is the loop signal. If the system is connected to just one sound source, such as a TV, some hearing aid users say the lack of background noise makes them feel isolated. This can be overcome by positioning a microphone where it will convey background noise and pick up general conversation - this can be easily achieved using our Outreach input extension system. See page 10 for details.

A typical PDA102C counter loop system

AMT microphone

Position the AMT microphone as close as possible to mouth height using the self-adhesive pad supplied. For optimum performance it should be located no nearer than 300mm and no further than 1.2m away from the operator's mouth. Avoid mounting it alongside sources of unwanted noise such as the cooling fan on a computer, a ringing telephone or near clothing or papers that can cause rustling noises.

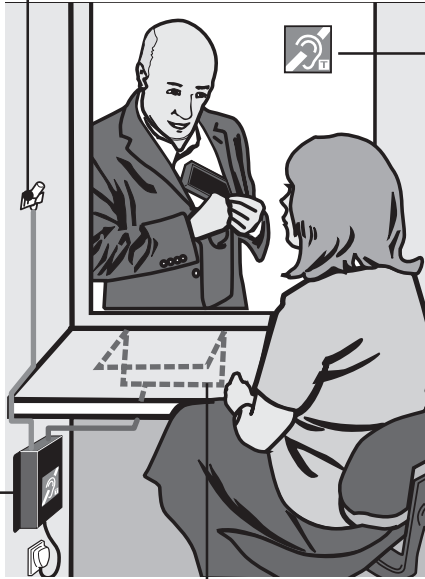

AFILS sticker

Put the 'induction loop in use' sticker where it can be clearly seen by members of the public.

Amplifier location

Carefully mount the amplifier to the side of the counter using the No.8 woodhead screws supplied. Alternatively, if a shelf is available you may wish to leave the amplifier free-standing.

Loop cable

Fix the pre-formed counter loop to the underside of the desk, counter or table using the cable ties and adhesive pads supplied so that any hearing impaired person visiting the counter naturally stands in front of it while in conversation.

For best results in counter applications:-

Bend the opened out 'squared' loop at a right angle half way down its length. Secure half the square to the underside horizontal surface of the desk and run the other half down the inside of the back vertical surface.

For best results in desk/table applications:-

Secure the opened out 'squared' loop to the underside of the table at the end nearest to the hard of hearing user.

Another option is to fit the loop above a suspended ceiling.

Again position the loop so that it is central to where the hearing impaired person would naturally stand. If coverage is not sufficient, discard the TX121 pre-formed counter loop and instead fit a 2m x 2m ceiling loop using 0.5mm² tri-rated cable (such as our own LOOP1/B or LOOP1/W cable).

The loop will not interfere with computer keyboards but may cause the screen to judder if placed too close to some monitors.



MULTIPLE COUNTER LOOPS

If multiple counter loops are required in close proximity, it is possible that the 'field' generated by one system may be picked up by a person who is standing at the next. Adjust the field strength, loop shape and position to avoid this.

A typical PDA102R small room system ('Outreach' plated mic. version)

Loop cable

Run the loop cable (supplied) around the perimeter of the room. It is best located at ceiling height (perhaps above a suspended ceiling) or tucked under the edge of a carpet or fixed to skirting boards.

If installing a floor loop, ensure the loop cable is adequately fixed and protected against being crushed in walkways or by furniture.

APM omni-directional plated microphone

Provides typical coverage of up to 25m² when located at a ceiling height of 2.5-3m. For optimum performance, the APM is best mounted onto a standard 25mm back box, ideally set into a suspended ceiling although it can also be set into a desk or mounted onto a wall.

If mounting the microphone at ceiling height, avoid positioning it too close to ceiling ventilators or air conditioning ducts as their noise can overpower the sound from talkers. If this means the microphone cannot be mounted where it will pick up adequately, a suspended ceiling mic. may be more appropriate.

6m of screened audio cable is included for connecting the APM to the PDA102 amplifier with longer lengths available from your distributor if required.



AFILS sticker

Put the 'induction loop in use' sticker where it can be clearly seen by members of the public.

Amplifier location

Carefully mount the amplifier to an appropriate surface using the No.8 woodhead screws supplied. Alternatively, if a shelf is available you may wish to leave the amplifier free-standing.

To avoid unsightly connection leads being on display, some installers prefer to mount the PDA102 above suspended ceilings, particularly if a ceiling loop is being fitted to reduce wiring runs.



Additional microphones

Longer rooms may require additional microphone coverage. If so, extra APM microphones can be daisy-chained to the PDA102's 'Outreach' connector. See page 10 for further details

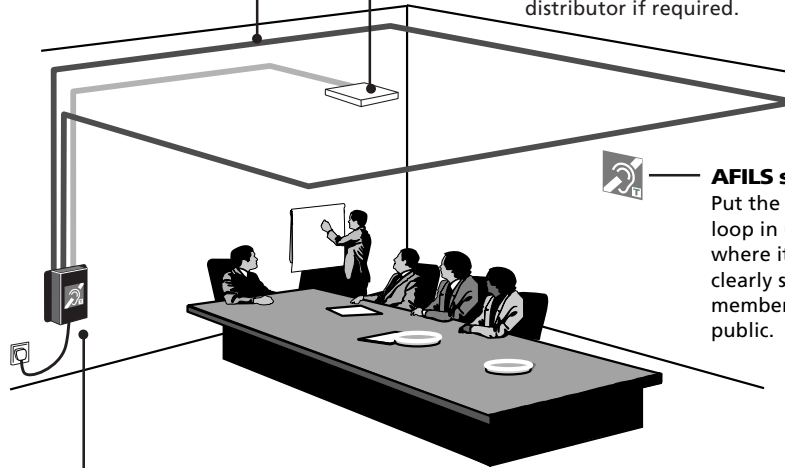

A typical PDA102L small room system (tie/desk mic. version)

AMT Microphone

Position the AMT microphone as close as possible to the user using the self-adhesive pad or other fittings supplied. For optimum performance it should be located no nearer than 300mm and no further than 1.2m away from the operator's mouth. Avoid mounting it alongside sources of unwanted noise such as the cooling fan on a computer, a ringing telephone or near clothing or papers that can cause rustling noises.

AFILS sticker

Put the 'induction loop in use' sticker where it can be clearly seen by members of the public.

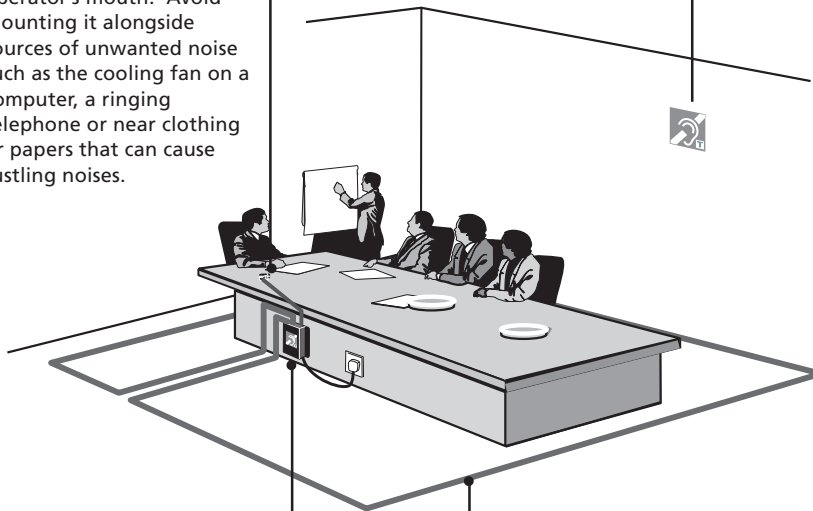

Amplifier location

Carefully mount the amplifier to an appropriate surface using the No.8 woodhead screws supplied. Alternatively, if a shelf is available you may wish to leave the amplifier free-standing.

Loop cable

Run the loop cable (supplied) around the perimeter of the room. It is best located at ceiling height (perhaps above a suspended ceiling) or tucked under the edge of a carpet or fixed to skirting boards.

If installing a floor loop, ensure the loop cable is adequately fixed and protected against being crushed in walkways or by furniture.

A typical PDA102S TV Lounge kit

APL dual phono line level 'outreach' connection plate

Surface mount the APL plate onto a standard 25mm UK back box - a 6m length of audio cable is provided for connecting the APL to the PDA102 and this can be cut to the desired length. The APS SCART lead, supplied, should then be connected to the audio source (normally a TV) and the APL plate as appropriate.

Amplifier location

The amplifier should be sited as close as possible to the audio/visual source to which it is connected. If required, it can be wall-mounted using the No. 8 woodscrews, supplied, or be left free-standing.



AFILS sticker

In applications such as communal TV lounges in nursing homes, put the 'induction loop in use' sticker where it can be clearly seen by hearing aid users.

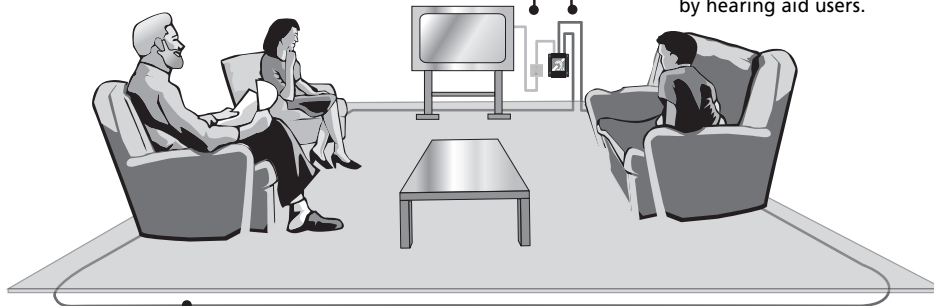

Loop cable

Run the loop cable (supplied) around the perimeter of the room. It is best tucked under the edge of the carpet or fixed to skirting boards or the ceiling.

If installing a floor loop, ensure the loop cable is adequately fixed and protected against being crushed in walkways or by furniture.

Optional microphone

To amplify general conversation and/or the sound of telephones or doorbells ringing, an optional microphone, not supplied, can be connected to the amplifier's 3.5mm jack socket.



AUDIO SOURCES WITHOUT OUTPUT SOCKETS

Some older televisions and other audio-visual appliances may not have a suitable output socket for direct connection to the PDA102.

NEVER attempt to make your own connections by opening the appliance as **VERY** high voltages are present that will damage the induction loop amplifier and may cause serious injury.

Overview of the Outreach plate audio input extension system

The PDA102 is fully compatible with the outreach plate audio input extension system. This system allows the connection of multiple microphone or line level inputs via a range of specially designed wall, ceiling or desk mountable single gang plates covering the most common variants of audio connector.

Up to ten Outreach plates (any mix) can be daisychained to the amplifier's 'Outreach' connector with cable lengths of up to 100m (total network length) easily achievable using standard two pair audio cable such as Belden 8723 - see typical wiring diagram below. Mountable on 25mm surface back boxes, plates can be located at any convenient point on an installation, overcoming the need for excessively long microphone and audio leads.

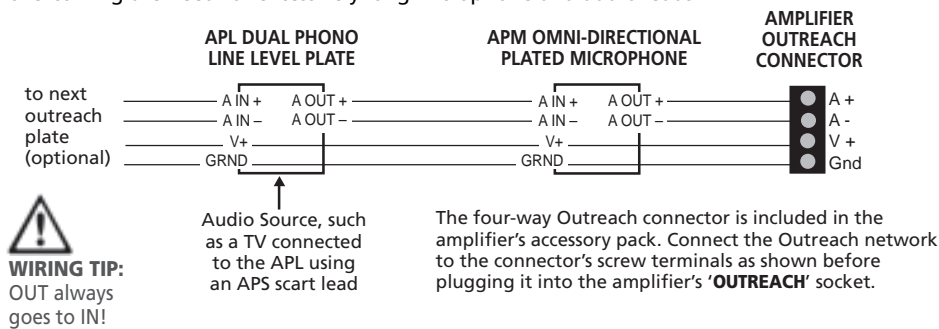

Outreach plate variants

APM OMNI-DIRECTIONAL PLATED MIC



A self-contained omni-directional electret microphone complete with on-board mic to line level converter. Typical coverage up to 25m² when located at a ceiling height of 2.5-3m.

APXM XLR 3 PIN MICROPHONE PLATE

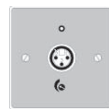

Accepts balanced or unbalanced microphones with standard 3 pin XLR connectors. Includes an on-board mic to line level converter, high gain pre-amplifier and 8V phantom power.

APL DUAL PHONO LINE LEVEL PLATE

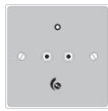

Accepts dual phono line-level signals (usually from a stereo source such as a TV). Includes an on-board dual phono to mono converter. (An APS SCART to dual phono lead is also available to facilitate the connection of TVs, etc).

APXL XLR 3 PIN LINE LEVEL PLATE

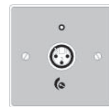

Accepts standard 3 pin XLR feeds from audio equipment such as stage or church mixing desks, etc.

APJ 3.5mm MICROPHONE JACK PLATE



Accepts unbalanced electret microphones with 3.5mm mono jack plugs. Includes an onboard mic to line level converter, high gain pre-amplifier and 8V phantom power.

APQL 6.35mm (1/4") LINE LEVEL PLATE



Accepts 6.35mm (1/4") jack feeds from audio equipment such as stage or church mixing desks, etc.

APQM 6.35mm (1/4") MICROPHONE JACK PLATE



Accepts balanced or unbalanced electret microphones with 6.35mm (1/4") jack plugs. Includes an on-board mic to line level converter, high gain pre-amplifier and 8V phantom power.

API 'AFILS ACTIVE' PLATE



Includes two ultra-bright LEDs in a translucent diffuser overprinted with the induction loop 'ear' symbol. The LEDs illuminate when the Outreach network is powered to indicate that an AFILS system is installed.

Installation

Safety precautions



Please refer to the safety precautions below before attempting to make any connections or operating your PDA102 loop amplifier.

Ensure the amplifier IS NOT located in areas with poor ventilation, high ambient temperatures or high levels of humidity, moisture or dust. It SHOULD NOT be exposed to direct sunlight or water or be placed next to vibrating or heat-generating equipment.

DO NOT dismantle or attempt to modify the amplifier in any way. No user-serviceable fuses or parts are included inside the amplifier. For repair, consult your distributor/supplier.

Ensure the AC power lead, the loop cable and all relevant audio/microphone lead(s) are fixed securely into position before operation. Do not leave any trailing leads.

The AC power lead has a moulded plug. If you need to remove the plug, it must be replaced with one that meets BS1363, or equivalent, fitted with a 3A fuse. As the colours of the wires in the lead may not correspond to the markings in your plug, connect as follows:-

Green and yellow wire to 'E' mark, '⊕' mark, 'Green' mark or 'Green and Yellow' mark

Blue wire to 'N' mark, 'Black' mark or 'Blue' mark

Brown wire to 'L' mark, 'Red' mark or 'Brown' mark

Mounting the amplifier

The amplifier can be wall-mounted using the No. 8 japanned woodscrews (supplied) or be left free-standing on a shelf, tabletop or desk.

Free-standing

If you wish to use the PDA102 free-standing, the four self-adhesive rubber feet provided in the amplifier's accessory pack should be stuck to the underside of the unit as shown (right). Note that the adhesive can take some time to set and therefore the amplifier should be handled with care until it is located in its final position.

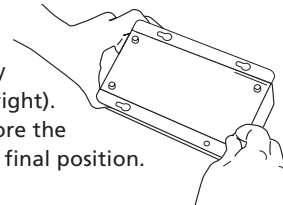

Wall-mounting

Using the four mounting holes provided (see right), fix the amplifier securely to the chosen wall, desk or counterside as appropriate. The mounting holes are suitable for use with the No.8 japanned woodscrews supplied. These will be suitable for most applications. However, always assess the condition and construction of the mounting surface prior to installation and use an alternative screw fixing if necessary.

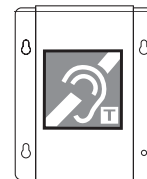

Identification

We recommend you apply one of the 'induction loop in use' stickers supplied with the PDA102 to the amplifier's top surface to help identify it as an induction loop system (see above).

Connecting and testing the system



**IMPORTANT : DO NOT POWER UP THE SYSTEM UNTIL STEP 6 BELOW.
THE AMPLIFIER SHOULD NOT BE OPERATED WITHOUT A LOOP CONNECTED.**

- 1 Install the loop - see **Planning the System**, pages 5 to 9, for example layouts and cable fixing advice.
- 2 Before connecting the loop to the PDA102, use a multimeter to check the loop is not shorted to ground at any point. It WILL almost certainly damage the amplifier if it is.
- 3 Remove approximately 6mm of the outer insulation from each end of the loop cable supplied. Connect the loop cable by pushing one end into the amplifier's **Loop Output +** terminal and the other into the **Loop Output -** terminal. To do this, insert a terminal screwdriver into the small rectangular slot below the cable insertion hole, this will open the insertion hole and allow the cable to be pushed into the connector. Remove the terminal screwdriver and the connector will close gripping the cable. Ensure the connector is gripping the conductor in the cable and not the insulation.

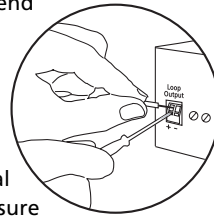

- 4 Connect a microphone and/or outreach input signal to the amplifier as shown (right).

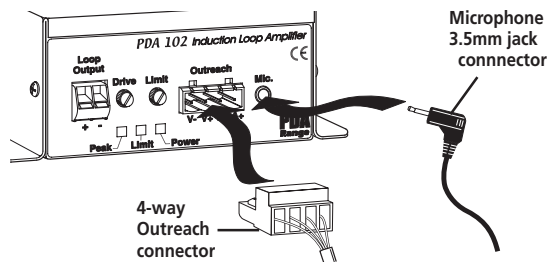

For more detailed information on Outreach plate wiring see page 10.

- 5 Ensure the amplifier's **Limit** and **Drive** controls are set to minimum by turning them fully anti-clockwise.



- 6 Connect the AC power lead (supplied) to a 230V a.c. wall socket and the amplifier's 230V 50/60Hz 20W socket as shown and ensure the amplifier's green **Power** indicator lights.

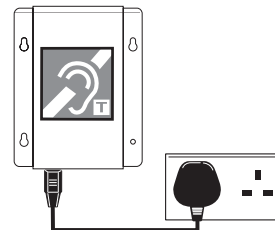

- 7** With the audio input source(s) active, increase the **Limit** level control until the red **Limit** indicator is just flashing occasionally.

TIP: If you are using the microphone and outreach input at the same time, adjust the level control on each outreach plate to achieve an acceptable balance.

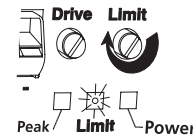

- 8** Adjust the **Drive** level control until the red **Peak** indicator just lights during periods of high signal level (i.e. when the red limit indicator just lights). Warning: If the system is set up so the Peak indicator is permanently lit, the audio sound quality will be distorted and the amplifier may shutdown to protect it against overheating.

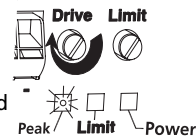

- 9** Using an induction loop test receiver, listen to the loop signal in the centre of the loop. If the signal level is not acceptable, adjust the **Drive** control in small increments until it is. When you are satisfied with the signal in the centre of the loop, move around the room to ensure coverage is consistent throughout. Pay particular attention to areas where hearing aid users are likely to gather.

Note that when testing the installation, you may hear a slight 'humming' noise in the background. This IS NOT a fault with the induction loop system but a common occurrence caused by mains wiring. This hum will normally NOT be heard by hearing aid users as most modern hearing aids have filters which cancel this noise out.



Additional testing (to BS7594)

For compliance with BS7594 (the code of practice for audio-frequency induction loop systems), we recommend you also check the system using a pink noise generator and magnetic field strength meter.

BS7594 recommends that the magnetic field strength of an AFILS over a covered area should be 100mA RMS average peaking to 400mA per metre. The most efficient way of ensuring this requirement is met is to measure the magnetic field strength of a steady output from the induction loop amplifier.

Unlike music or speech (both of which provide a variable sound output from which it is virtually impossible to obtain an accurate RMS reading), pink noise has an equal and constant amount of energy content per octave of bandwidth. When fed into an AFILS system, pink noise therefore gives a constant magnetic field strength which can be easily and accurately measured using a magnetic field strength meter.

The following items of cost-effective PDA RANGE test equipment can be used to verify both the audio quality and the magnetic field strength of any AFILS system. ALWAYS refer to the more detailed information supplied with each unit before starting any tests.

- RXTI2 Induction loop listener (part no RXTI2)
- P-Ngen Pink noise generator (part no. PNGN)
- FoSmeter Magnetic field strength meter (part no. AHHM)
- FoSmeter+ Combined pink noise generator & magnetic field strength meter (part no. AMPN)
- FoSmeter H Combined magnetic field strength meter & loop listener (part no. AHHM/H)
- Headphones for use with FosMeter H (part no. HEAD1)

Contact your PDA RANGE distributor/supplier for pricing details.

Troubleshooting

If no sound is being picked up by the hearing aid or induction loop test receiver, first check that the amplifier's green **Power** indicator is lit.

If the Power indicator IS NOT lit:-

Check that the AC power lead is correctly plugged into the mains supply and the amplifier.

If the power indicator is still not lit, the AC power lead or the amplifier could be faulty.

Check the amplifier with another AC power lead. If the problem persists, return the amplifier to your distributor/supplier for repair.

If the Power indicator IS lit:-

Check that the amplifier's **Limit** indicator is lit and that an audio signal is active.

If the **Limit** indicator IS NOT lit, make sure all microphone and audio connection leads are correctly plugged in and at least one audio source is active.

Adjust the amplifier's **Limit** control until the **Limit** indicator just flickers.

If there is still no sound being picked up by the hearing aid or induction loop test receiver, check that the loop cable is not broken or misconnected.

Tip: The loop strength meter WILL NOT illuminate if there is a break in the loop cable or if it is misconnected.

PDA102 technical specifications

Rated supply voltage and frequency: 230VAC @ 50/60Hz

Rated power consumption: 20W

Maximum r.m.s. output current: 2.1A

Maximum peak output current: 2.8A

Maximum r.m.s. load voltage: 5.5V

Total harmonic distortion: <0.1%

Maximum area of a square loop: 49m² (7m x 7m)

Recommended loop conductor size: 0.5mm² @ <35metres loop length or 1.0mm² @ >35metres to <50metres loop length (inc. tails)

Recommended number of turns: 1

Frequency response -3dB: 120Hz to 5kHz as per IEC 60118-4

Input signal level: Mic: -50dBV Unbalanced, Outreach: -10dBV balanced (Referenced to full output 1kHz sine wave into 1ohm load with controls at maximum)

Input impedance: Mic: 1k-Ohm; Outreach: 20k-Ohm

Microphone phantom power: 9V DC

Signal to noise ratio: -62dB

AGC Ratio: 2:1

Amplifier mode: True Current Mode

Control and indicator labels and functions: Green Power LED, Red Limit LED, Red Peak LED, Limit control, Drive control.

Special features: Outreach plate connector allowing the connection of up to 10 outreach plates.

Connections: Mains - IEC Socket 230V 20W; Loop Output - 2 Way Push Terminal; Outreach - 4 Way Plugable screw terminal; Microphone - 3.5mm mono jack socket.

Fixings: 4 x No.8 Japanned Woodscrew (supplied)

Dimensions (H x W x D): 56mm x 136mm x 175mm (inc. connectors)

Mass: 1.25 kg (excluding packing and accessories)

© 2004. Errors and omissions excepted.
The manufacturer of this equipment operates a policy of continuous improvement and reserves the right to alter product specifications at its discretion and without prior notice.