

KEMET Part Number: HHBC14-1R2A0187V
(UALC141R2A0187)

KEMET, HHBC, AC Line Filters, Normal Mode, 187 uH, 20%

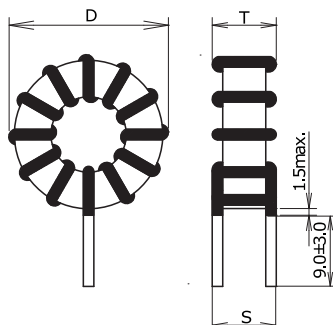

Dimensions	
D	34mm MAX
T	19.4mm MAX
LL	9mm +/-3mm
S	15mm NOM

Packaging Specifications	
Packaging:	Tray
Packaging Quantity:	120
Weight:	45 g

General Information	
Series:	HHBC
Style:	Through-Hole
Features:	Noise Solution, Switching Power Supply Outlets, DC-DC Converter
RoHS:	Yes
Miscellaneous:	60 (K) Temperature Rise Max.

Specifications	
Inductance:	187 uH
Inductance Tolerance:	20%
Current:	8 A
Temperature Range:	-40/+125°C
DC Resistance:	37.6 mOhms