

## RS Pro High Pressure Pump Range, Self-Priming, Brushless Drive

Stock No: 125-3585

The MGD1000 series micropump, delivers consistent pulseless flow with high or low pressure. They are suitable for a wide range of liquids and are self-priming. The MGD1000 can be used with all common liquids and will also resist most chemicals and solvents. The pump has two connection options; stainless steel threaded tubing connectors for quick and easy connection to tubing, or for directly mounting to your manifold. Its flow direction is reversible.

Delivering a smooth consistent, almost pulseless flow, throughout the pressure range, these pumps are particularly suitable for systems where pressure and flow consistency are key requirements.

### Features

- High pressure capability
- Self-priming
- High and low viscosity liquids
- Smooth almost pulseless flow
- Reversible flow
- High chemical resistance
- Small size only 65 x 32 x 30 mm
- 1/8 bsp Connectors or Manifold
- No dynamic seal



### \* Important \*

**These motors require a separate controller to operate!**

The MGD1000 pump range utilizes high performance, efficient sensorless brushless motor technology.

TCS Micropumps offer the EQi range of controllers for this purpose.



## Datasheet

## Typical Applications

- High pressure capability
- Self-priming
- High and low viscosity liquids
- Smooth almost pulseless flow
- Reversible flow
- High chemical resistance
- Small size only 65 x 32 x 30 mm
- 1/8 bsp Connectors or Manifold
- No dynamic seal

## MGD1000 Pump Options Data

The TCS MGD1000 range come in 3 different options that can make your pump more suited to your needs. Standard, Pressure & Flow.

All MGD1000 pump variants are capable of more than the indicated figure but exceeding this may result in damage to the pump.

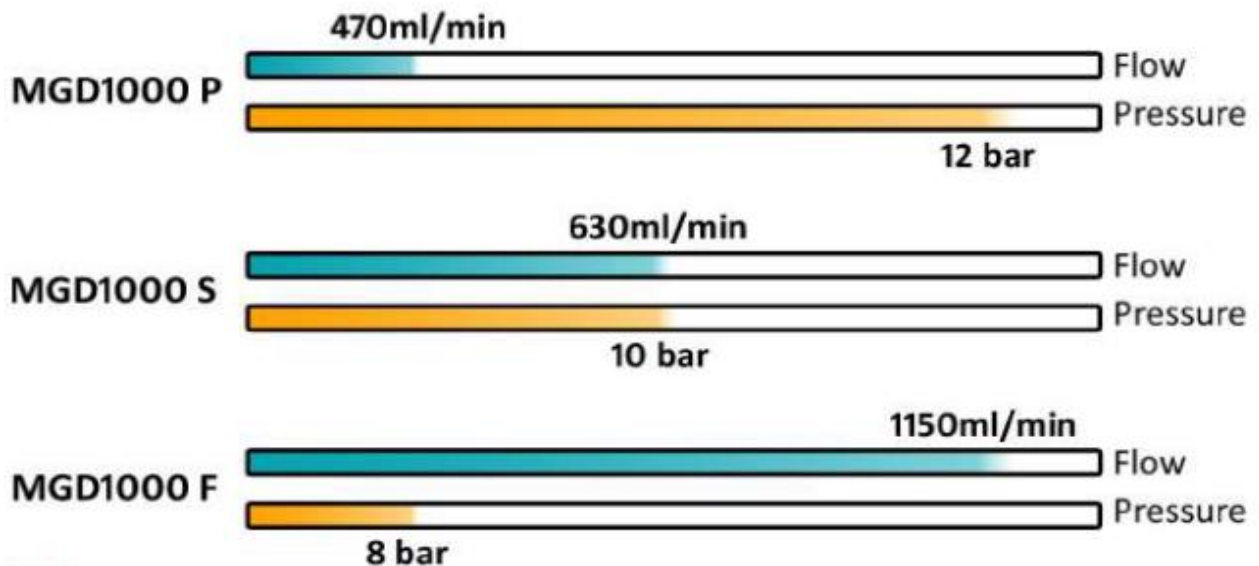

# Datasheet

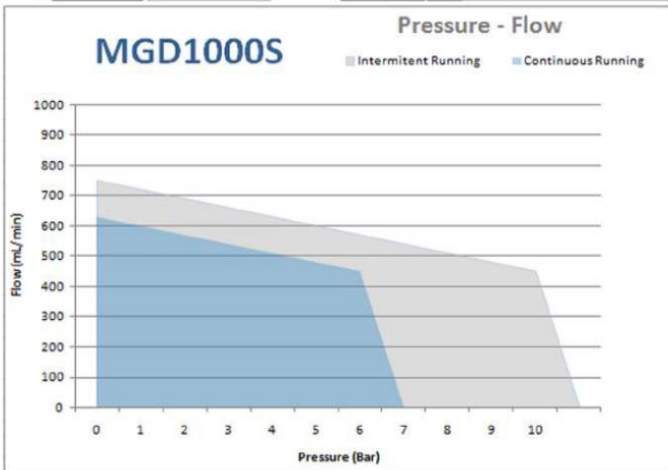
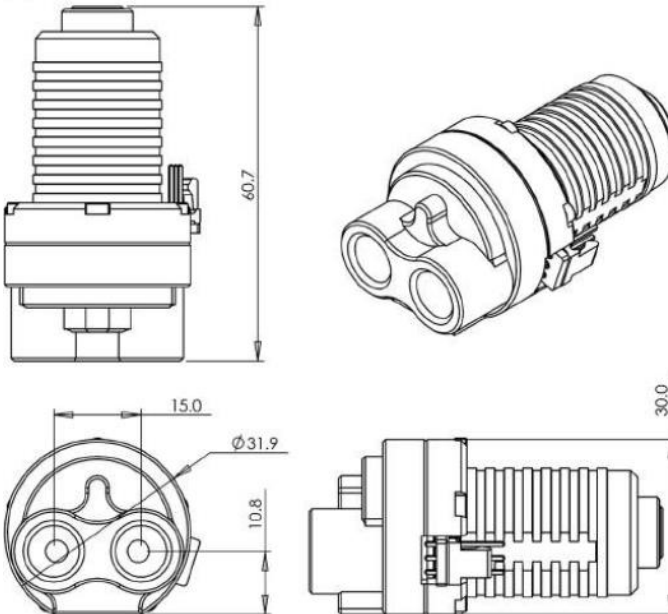

## Customising and Tailoring your Pump

TCS can offer you variants of any stock pump, to suit your requirements. If you need other seal options, materials, specific performance etc, TCS can configure pumps and systems or provide new, unique solutions developed and tailored exactly to your needs.

New variants and concepts are also designed and developed to suit specific customer requirement by the TCS in-house design and development unit.

If you have a specific requirement that demands a unique pump or system then get in touch.



## Technical Data

- Size 65 x 32 x 30mm
- Weight (exclduing connectors) 110 g
- Maximum Free Flow 630ml/min
- Operating Temp - High 100 °C
- Operating Temp - Low -80 °C
- Max Viscosity 5,000 cSt
- Max Differential Pressure (Continuous) 6 Bar
- Max Differential Pressure (Intermittent) 10 Bar
- Max System Pressure 100bar+
- Max Continuous Current 1.8A
- Wetted Parts: 316 Stainless Steel, PEEK, Ertalyte, Viton
- Fluid Connection - Standard 1/8bsp (female)
- Fluid Connection - Manifold (see web for details)
- Typical Life >20,000hrs
- IP Rating - Standard pump IP45
- IP Rating - Waterproof version IP67
- Intergrated drive motor Sensorless Brushless
- Motor Control Type Brushless Driver required
- Electrical Connections
 

Standard Version -	TE MTA-100 3/1 Connector
Waterproof Version -	Stripped wires
- Lead Length 220mm
- Filter Recomendations 10microns
- Noise Levels (above ambient 50db at 1m) 15dB