

Anti-Vandal Illuminated Pushbutton Switch



Specification

Switch Rating	2A @ 36VDC
Electrical Life	200,000 cycles
Contact Resistance	50 mΩ
Insulation Resistance	1 GΩ
Dielectric Strength	2,000V RMS 50Hz
Operating Temperature	1500 V
IP Class	IP67,IK08
Torque	0.6 Nm applied to nut
Operating Force	4 N
Contact Configuration	1 NO
Switching Circuit	OFF-(ON)
LED Colour	Blue
Termination Type	Blade Terminal

Materials

Contact	Silver alloy
Base	PBT

Drawing

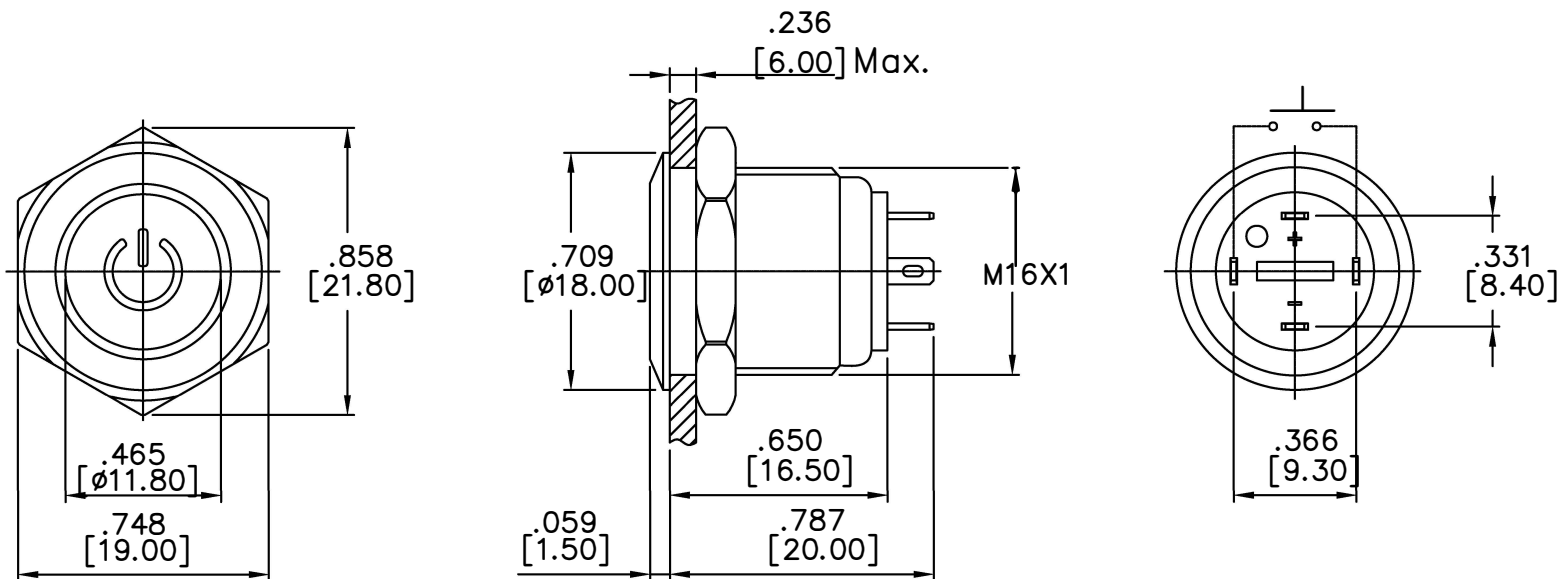

Art. Nr.
RND 210-00813

Drawing

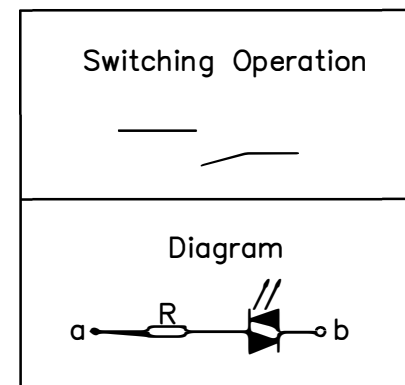
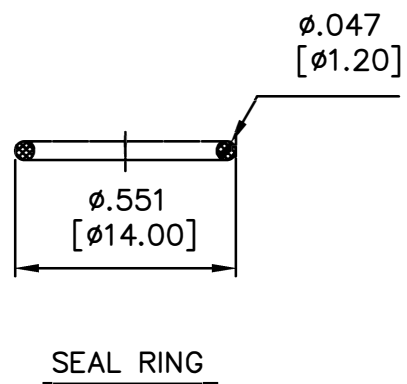
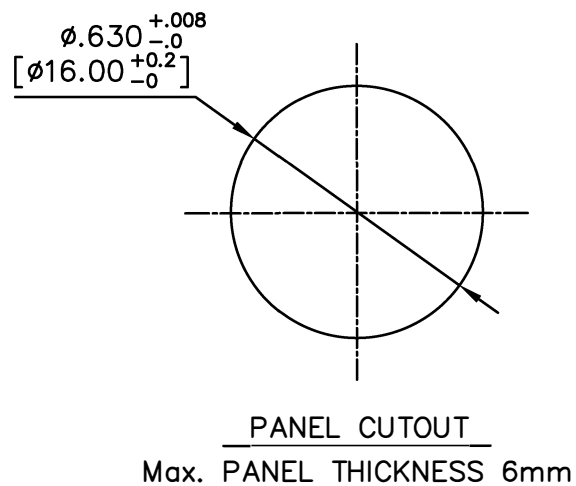

Art. Nr.
RND 210-00813